

# **Service Manual**

---

**MODEL: GVA60AH-M3NNA5A**  
**(Refrigerant R410A)**

**GREE ELECTRIC APPLIANCES,INC.OF ZHUHAI**

## Table of Contents

<b>Summary and Features</b> .....	1
<b>1.Safety Precautions</b> .....	2
<b>2.Specifications</b> .....	3
2.1 Unit Specifications .....	3
2.2 Capacity Variation Ratio According to Temperature .....	5
2.3 Operation Data .....	5
<b>3.Construction Views</b> .....	6
3.1 Indoor Unit .....	6
3.2 Outdoor Unit .....	7
<b>4.Refrigerant System Diagram</b> .....	8
<b>5.Schematic Diagram</b> .....	9
5.1 Electrical Data .....	9
5.2 Electrical Wiring .....	9
5.3 Printed Circuit Board .....	11
<b>6.Function and Control</b> .....	12
6.1 Remote Control Operations .....	12
6.2 Function Buttons of Air Conditioner .....	15
6.3 Description of each Control Operation .....	19
<b>7.Installation Manual</b> .....	27
7.1 Important Notices .....	27
7.2 Installation Dimension Diagram .....	30
7.3 Installation of Indoor Unit .....	31
7.4 Installation of Outdoor Unit .....	35
7.5 Test Operation and Check after Installation .....	36
<b>8.Exploded Views and Parts List</b> .....	37
8.1 Indoor Unit .....	37
8.2 Outdoor Unit .....	39

---

<b>9.Troubleshooting</b> .....	41
9.1 Precautions before Performing Inspection or Repair.....	41
9.2 Confirmation .....	41
9.3 Judgement by Flashing LED of Indoor/Outdoor Unit.....	41
9.4 How to Check Simply the Main Part.....	44
<b>10.Removal Procedure</b> .....	52
10.1 Removal Procedure of Indoor Unit .....	52
10.2 Removal Procedure of Outdoor Unit .....	59

# Summary and Features

**Indoor Unit:**

GVA60AH-M3NNA5A/I

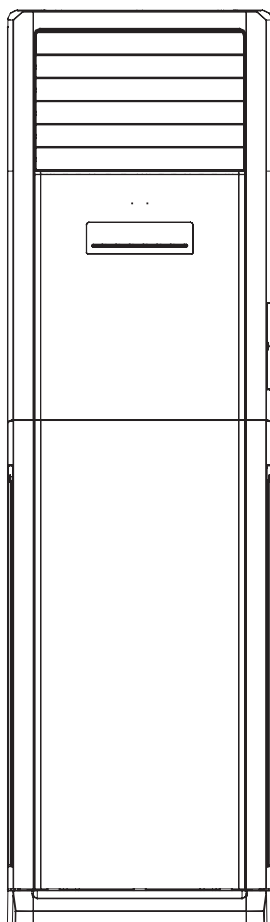

**Outdoor Unit:**

GVA60AH-M3NNA5A/O

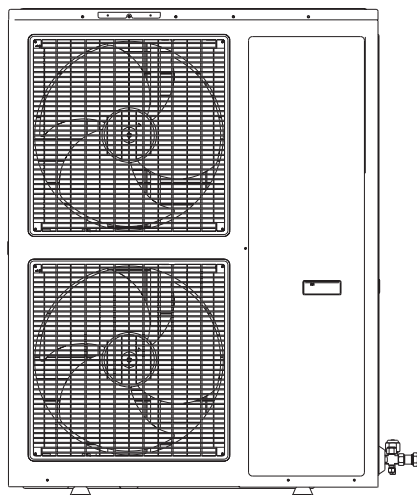

Remote Controller :

YB1F2



# 1. Safety Precautions

Installing, starting up, and servicing air conditioner can be hazardous due to system pressure, electrical components, and equipment location, etc.

Only trained, qualified installers and service personnel are allowed to install, start-up, and service this equipment. Untrained personnel can perform basic maintenance functions such as cleaning coils. All other operations should be performed by trained service personnel.

When handling the equipment, observe precautions in the manual and on tags, stickers, and labels attached to the equipment. Follow all safety codes. Wear safety glasses and work gloves. Keep quenching cloth and fire extinguisher nearby when brazing.

Read the instructions thoroughly and follow all warnings or cautions in literature and attached to the unit. Consult local building codes and current editions of national as well as local electrical codes.

Recognize the following safety information:

 **Warning** Incorrect handling could result in personal injury or death.

 **Caution** Incorrect handling may result in minor injury, or damage to product or property.

- Make sure the outdoor unit is installed on a stable, level surface with no accumulation of snow, leaves, or trash beside.
- Make sure the ceiling/wall is strong enough to bear the weight of the unit.
- Make sure the noise of the outdoor unit does not disturb neighbors.
- Follow all the installation instructions to minimize the risk of damage from earthquakes, typhoons or strong winds.
- Avoid contact between refrigerant and fire as it generates poisonous gas.
- Apply specified refrigerant only. Never have it mixed with any other refrigerant. Never have air remain in the refrigerant line as it may lead to rupture and other hazards.
- Make sure no refrigerant gas is leaking out when installation is completed.
- Should there be refrigerant leakage, the density of refrigerant in the air shall in no way exceed its limited value, or it may lead to explosion.
- Keep your fingers and clothing away from any moving parts.
- Clear the site after installation. Make sure no foreign objects are left in the unit.
- Always ensure effective grounding for the unit.

---

## Warning

All electric work must be performed by a licensed technician according to local regulations and the instructions given in this manual.

- Before installing, modifying, or servicing system, main electrical disconnect switch must be in the OFF position. There may be more than 1 disconnect switch. Lock out and tag switch with a suitable warning label.
- Never supply power to the unit unless all wiring and tubing are completed, reconnected and checked.
- This system adopts highly dangerous electrical voltage. Incorrect connection or inadequate grounding can cause personal injury or death. Stick to the wiring diagram and all the instructions when wiring.
- Have the unit adequately grounded in accordance with local electrical codes.
- Have all wiring connected tightly. Loose connection may lead to overheating and a possible fire hazard.

All installation or repair work shall be performed by your dealer or a specialized subcontractor as there is the risk of fire, electric shock, explosion or injury.

---

## Caution

- Never install the unit in a place where a combustible gas might leak, or it may lead to fire or explosion.
- Make a proper provision against noise when the unit is installed at a telecommunication center or hospital.
- Provide an electric leak breaker when it is installed in a watery place.
- Never wash the unit with water.
- Handle unit transportation with care. The unit should not be carried by only one person if it is more than 20kg.
- Never touch the heat exchanger fins with bare hands.
- Never touch the compressor or refrigerant piping without wearing glove.
- Do not have the unit operate without air filter.
- Should any emergency occur, stop the unit and disconnect the power immediately.
- Properly insulate any tubing running inside the room to prevent the water from damaging the wall.

## 2. Specifications

### 2.1 Unit Specifications

Parameter	Unit	Value	
Model		GVA60AH-M3NNA5A	
Product Code		CG090000200	
Power Supply	Voltage	V ~ 380-415	
	Frequency	Hz 50	
	Phases	3	
Power Supply Mode		Outdoor	
Cooling Capacity	W	15530	
Heating Capacity	W	19000(21500)	
Cooling Power Input	W	6190	
Heating Power Input	W	6530(9030)	
Cooling Current	A	10.50	
Heating Current	A	11(15.2)	
Rated Power Input	W	9800	
Rated Current	A	16.5	
EER	W/W	2.51	
COP	W/W	2.91	
SEER	W/W	/	
HSPF	W/W	/	
Air Flow Volume	m <sup>3</sup> /h	2000/-/-	
Dehumidifying Volume	L/h	6	
Set Temperature Range	°C	16 ~ 30	
Cooling Operation Ambient Temperature Range	°C	18 ~ 43	
Heating Operation Ambient Temperature Range	°C	-15 ~ 24	
Application Area	m <sup>2</sup>	80-100	
Indoor Unit	Indoor Unit Model		GVA60AH-M3NNA5A/I
	Fan Type		Centrifugal
	Diameter Length(DXL)	mm	Φ379X180.5
	Fan Motor Speed (Cooling) (SH/H/M/L/SL)	r/min	585/530/460/405/-
	Fan Motor Speed (Heating) (SH/H/M/L/SL)	r/min	585/530/460/405/-
	Fan Motor Power Output	W	210
	Fan Motor RLA	A	2.03
	Fan Motor Capacitor	μF	10
	Heater Power Input	W	2500
	Evaporator Form		Aluminum Fin-copper Tube
	Evaporator Pipe Diameter	mm	Φ7.94
	Evaporator Row-fin Gap	mm	3-1.5
	Evaporator Coil Length (LXDXW)	mm	836X62X472
	Swing Motor Model		MP35AA / MP35AB
	Swing Motor Power Output	W	4
	Fuse	A	5
	Sound Pressure Level (SH/H/M/L/SL)	dB (A)	54/52/50/47/-
	Sound Power Level (SH/H/M/L/SL)	dB (A)	64/62/60/57/-
	Outline Dimension (WXHXD)	mm	581X1870X395
	Package Carton Dimension (L/W/H)	mm	2080X735X530
	Package Dimension (L/W/H)	mm	2083X738X545
Net Weight	kg	63	
Gross Weight	kg	89	

Outdoor Unit	Outdoor Unit Model		GVA60AH-M3NNA5A/O	
	Compressor Manufacturer/Trademark		DALIAN SANYO COMPRESSOR CD.,LTD./SANYO	
	Compressor Model		C-SBN453H8D	
	Compressor Oil		DAPHNE FV68S	
	Compressor Type		Scroll	
	Compressor LRA.	A		67.0
	Compressor RLA	A		9.8
	Compressor Power Input	W		5750
	Overload Protector			Internal
	Throttling Method			Capillary
	Condenser Form			Aluminum Fin-copper Tube
	Condenser Pipe Diameter	mm		Φ9.52
	Condenser Rows-fin Gap	mm		3-1.8
	Condenser Coil Length (LXDXW)	mm		1219.2X66X802
	Fan Motor Speed	rpm		940
	Output of Fan Motor	W		92
	Fan Motor RLA	A		1.20
	Fan Motor Capacitor	μF		4
	Air Flow Volume of Outdoor Unit	m <sup>3</sup> /h		6000
	Fan Type			Axial-flow
	Fan Diameter	mm		Φ450
	Defrosting Method			Automatic Defrosting
	Climate Type			T1
	Isolation			I
	Moisture Protection			IP24
	Permissible Excessive Operating Pressure for the Discharge Side	MPa		4.3
	Permissible Excessive Operating Pressure for the Suction Side	MPa		2.5
	Sound Pressure Level (H/M/L)	dB (A)		63/-/-
	Sound Power Level (H/M/L)	dB (A)		73/-/-
	Dimension (WXHXD)	mm		1032X1250X412
	Dimension of Carton Box (L/W/H)	mm		1110X450X1280
	Dimension of Package(L/W/H)	mm		1113X453X1400
Net Weight	kg		117	
Gross Weight	kg		128	
Refrigerant			R410A	
Refrigerant Charge	kg		4.45	
Connection Pipe	Length	m	5	
	Gas Additional Charge	g/m	100	
	Liquid Pipe Outer Diameter	mm	Φ12	
	Liquid Pipe Thickness	mm	0.8	
	Gas Pipe Outer Diameter	mm	Φ19	
	Gas Pipe Thickness	mm	1.0	
	Max. Height Distance	m	20	
	Max. Length Distance	m	30	

The above data is subject to change without notice. Please refer to the nameplate of the unit.

## 2.2 Capacity Variation Ratio according to Temperature

### Cooling

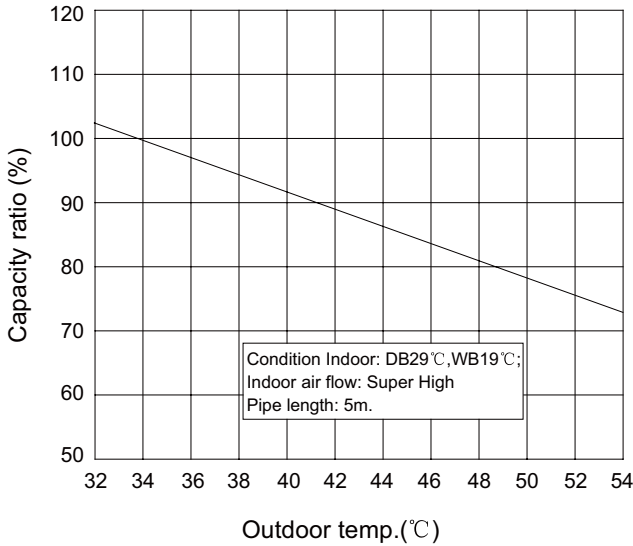

### Heating

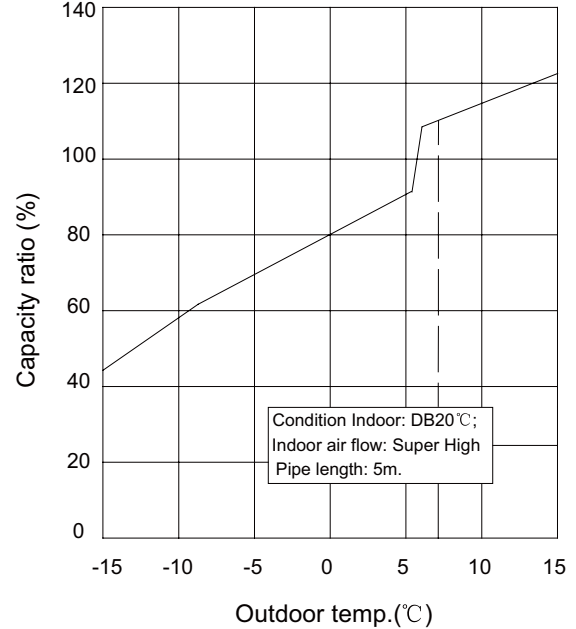

## 2.3 Operation Data

### Cooling

Temperature condition (°C)		Model name	Standard pressure P (MPa)	Heat exchanger pipe temp.		Indoor fan mode( rpm)	Outdoor fan mode( rpm)
Indoor	Outdoor			T1 (°C)	T2 (°C)		
29/19	46/24	GVA60AH-M3NNA5A	0.8~0.9	8~11 to 11~14	75~85 to 37~43	585	940

### Heating

Temperature condition (°C)		Model name	Standard pressure P (MPa)	Heat exchanger pipe temp.		Indoor fan mode( rpm)	Outdoor fan mode( rpm)
Indoor	Outdoor			T1 (°C)	T2 (°C)		
20/-	7/6	GVA60AH-M3NNA5A	2.8~3.1	75~80 to 37~43	1.0~3.0 to 3.0~5.0	585	940

#### NOTES :

- (1) Measure surface temperature of heat exchanger pipe around center of heat exchanger path U bent. (Thermistor thermometer)
- (2) Connecting piping condition : 5 m
- (3) T1: Inlet and outlet pipe temperature of evaporator,  
T2: Inlet and outlet pipe temperature of condenser,  
P: Pressure of air pipe connecting indoor and outdoor units.



### 3. Construction Views

#### 3.1 Indoor Unit

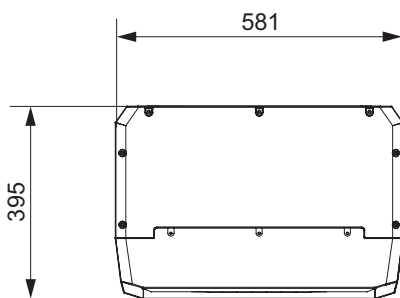
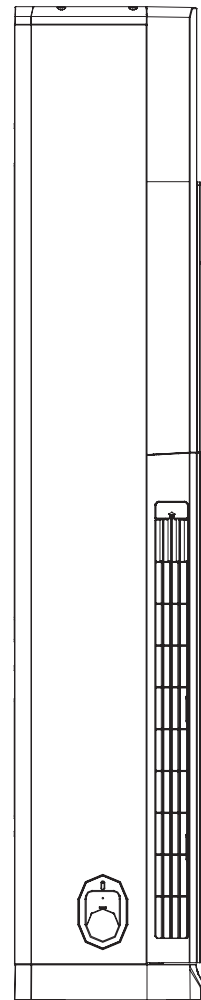
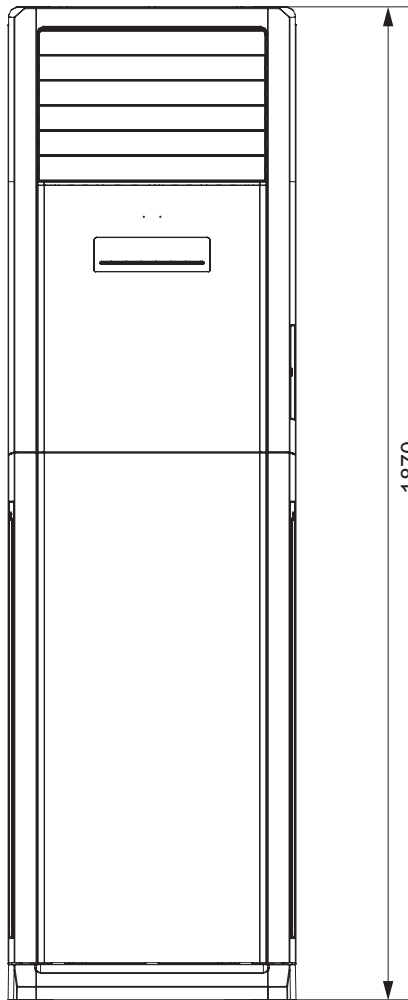

Unit:mm

### 3.2 Outdoor Unit

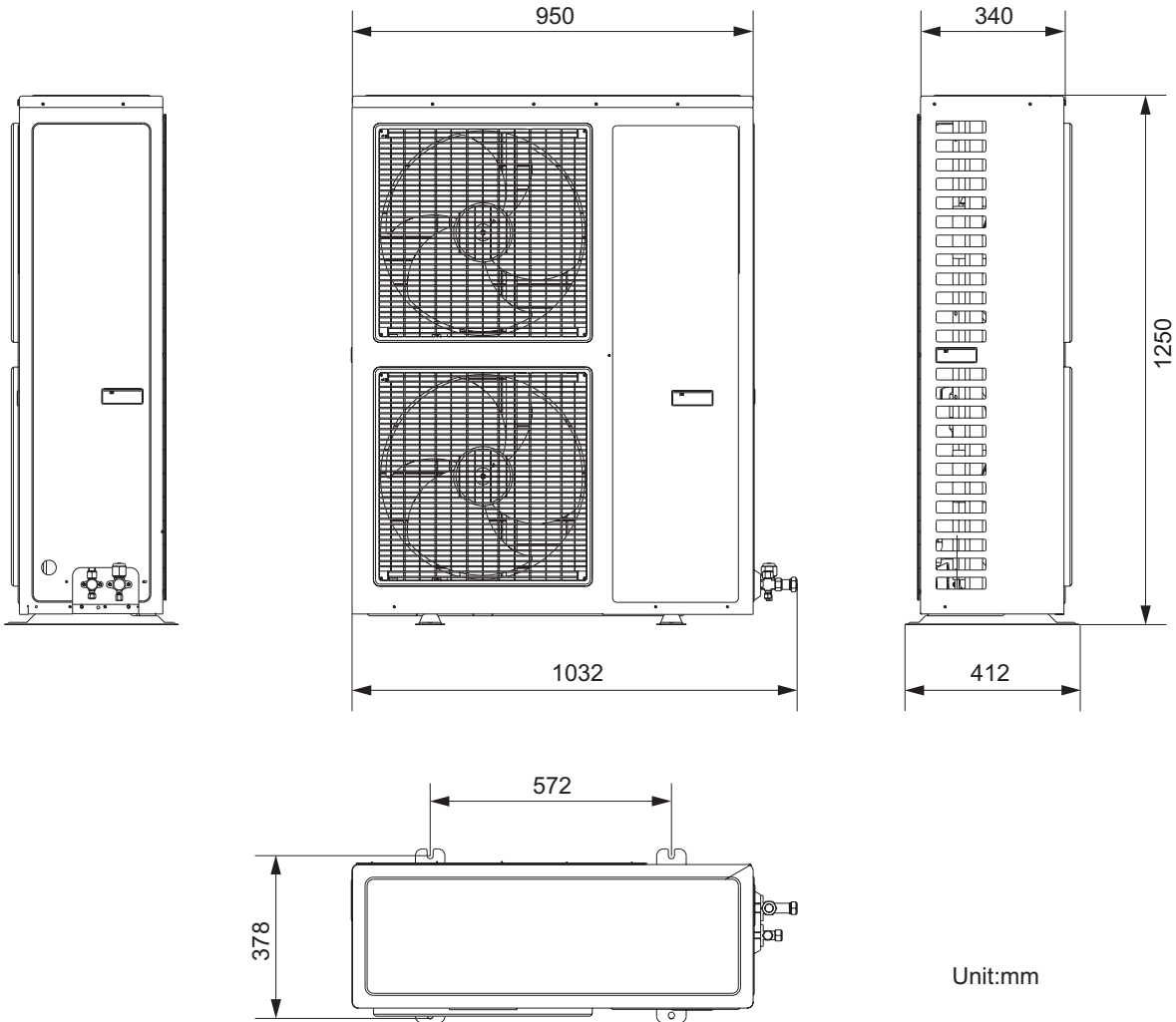

## 4.Refrigerant System Diagram

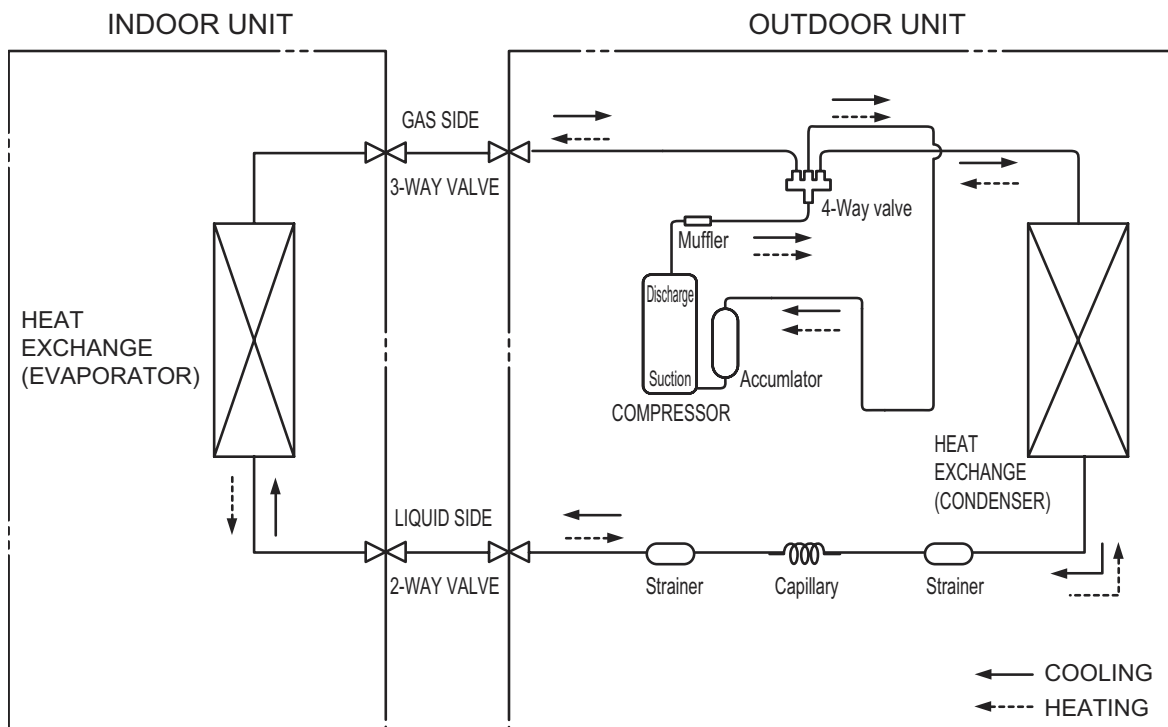

**Refrigerant pipe diameter**

**Liquid : 1/2" (12 mm)**

**Gas : 3/4" (19mm)**

## 5.Schematic Diagram

### 5.1 Electrical Data

#### Meaning of marks

Symbol	Parts name	Symbol	Color symbol	Symbol	Color symbol
SAT	OVERLOAD	BU	BLUE	VT	VIOLET
COMP	COMPRESSOR	YE	YELLOW	OG	ORANGE
⊕	PROTECTIVE EARTH	RD	RED	BK	BLACK
C1	CBB65	YEGN	YELLOW GREEN	BN	BROWN
C2	CBB61				

### 5.2 Electrical Wiring

#### Indoor Unit:

Model: GVA60AH-M3NNA5A/I

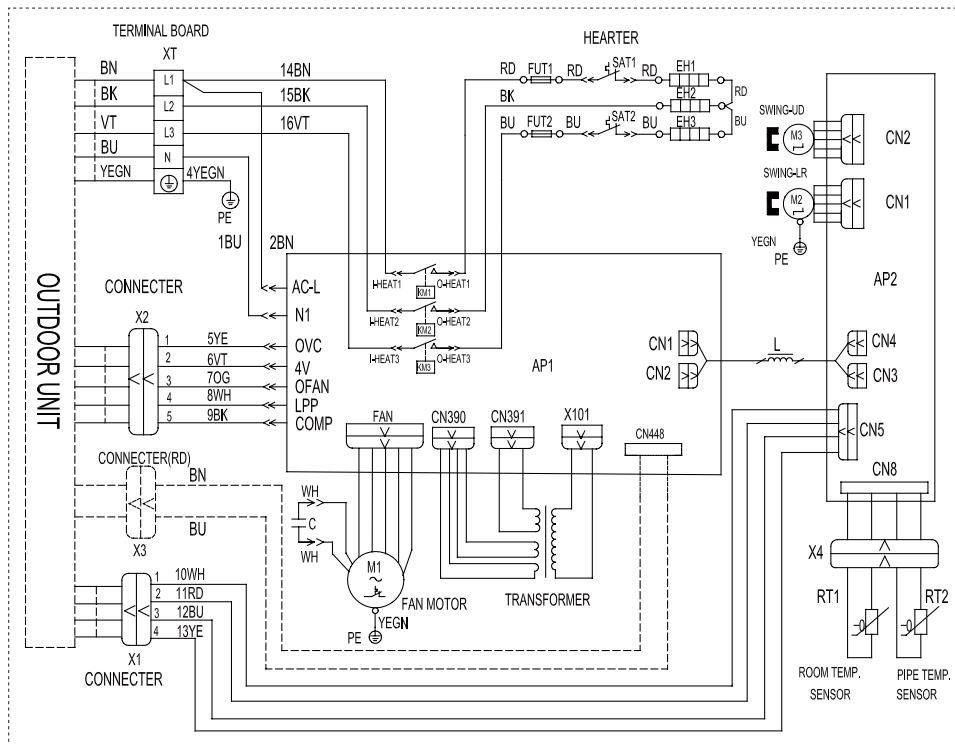

**Outdoor Unit:**

Model: GVA60AH-M3NNA5A/O

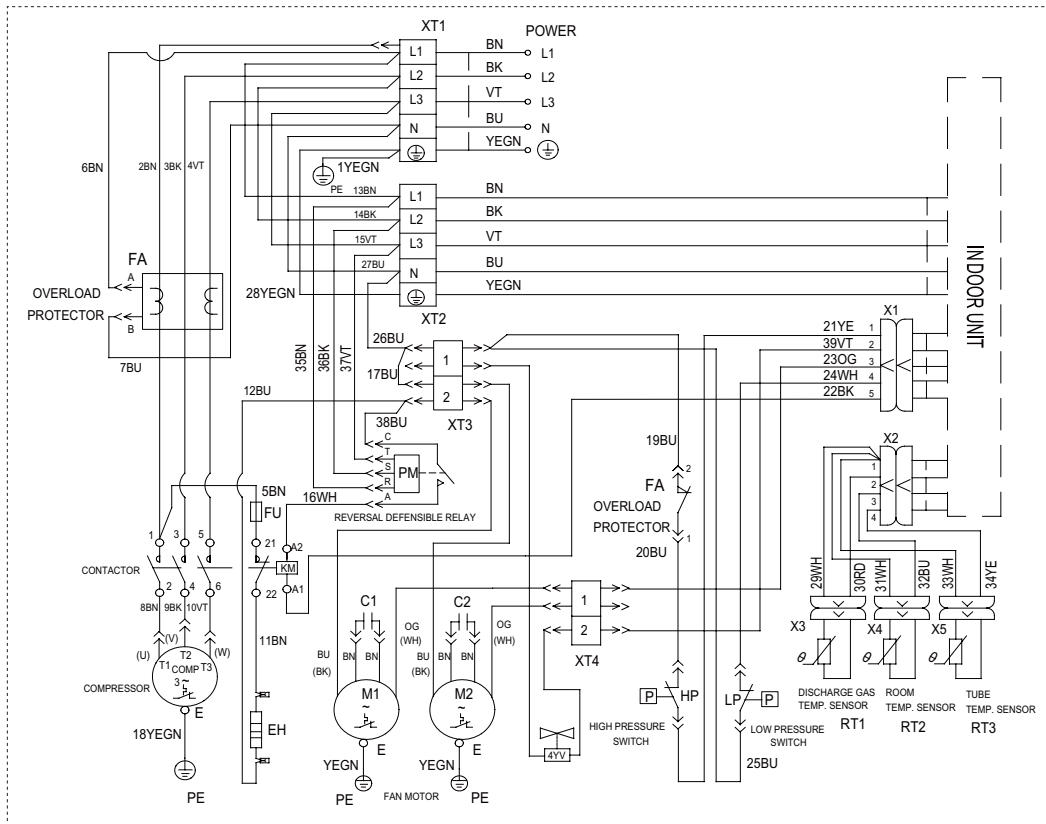

These circuit diagrams are subject to change without notice. Please refer to the one supplied with the unit.

## 5.3 Printed Circuit Board

• TOP VIEW

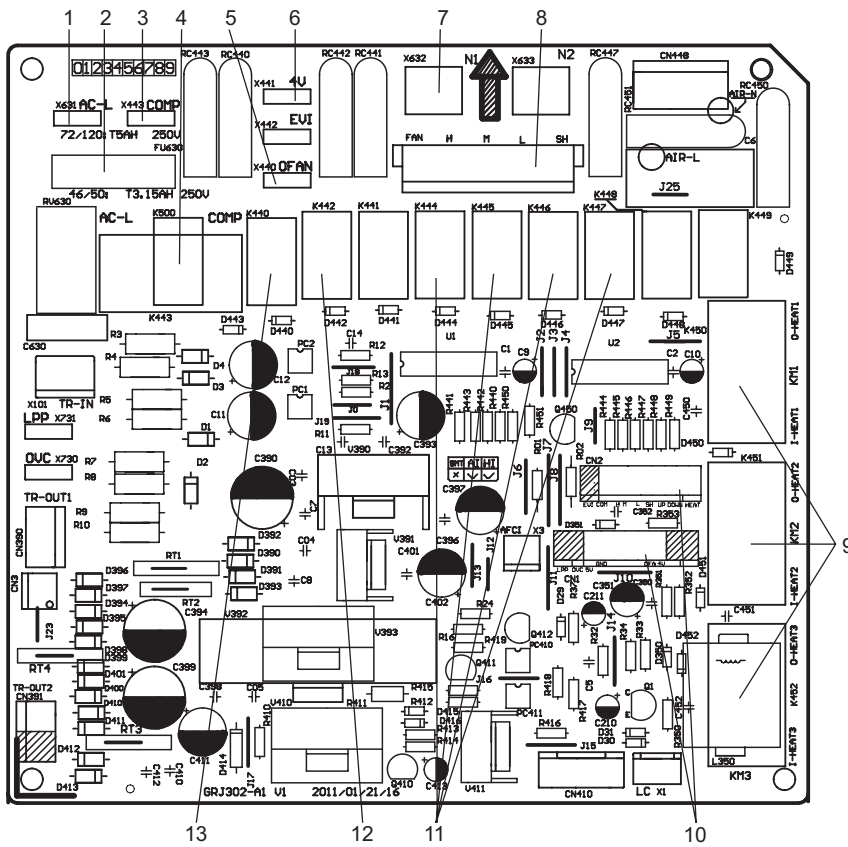

1	Copper insert of live wire
2	Protective tube
3	Copper insert of wire of compressor
4	Control relay of compressor
5	Copper insert of wire of outdoor fan
6	Copper insert of wire of 4-way valve
7	Copper insert of neutral wire
8	Wiring terminal of indoor fan
9	Relay of auxiliary heater
10	Terminals of DISP1 and DISP2
11	Control relay for 4-speed of indoor fan
12	Control relay of 4-way valve
13	Control relay of outdoor fan

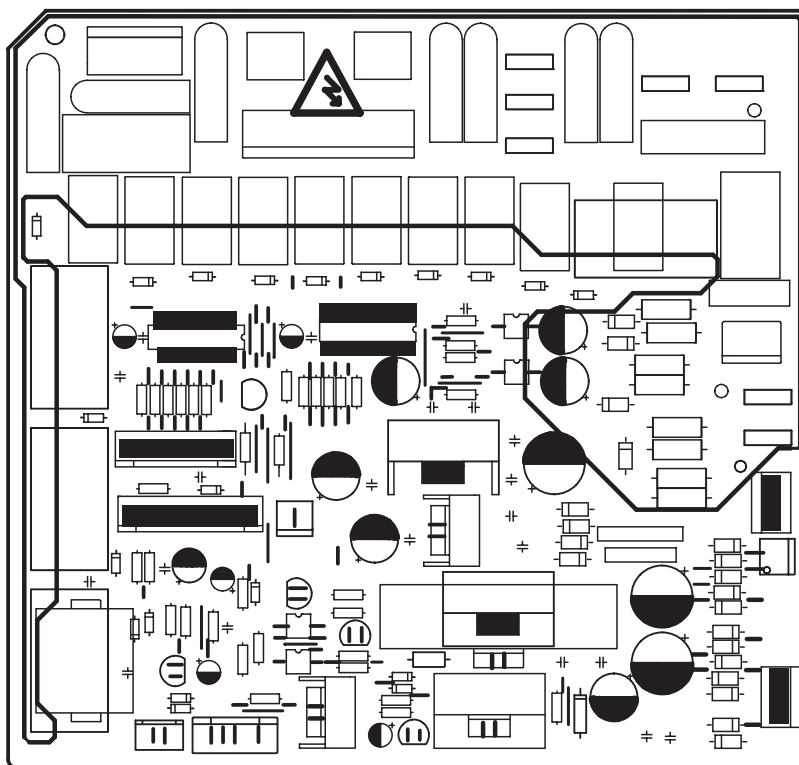

• BOTTOM VIEW





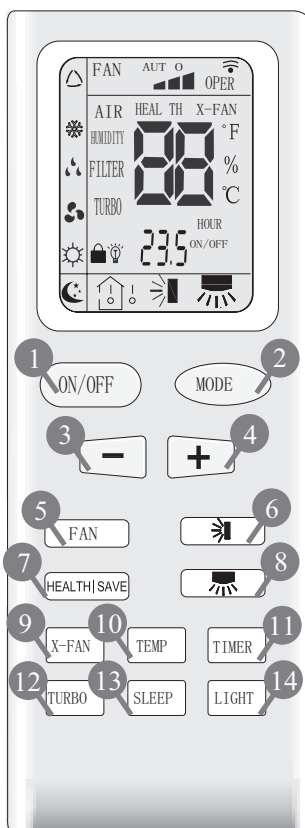



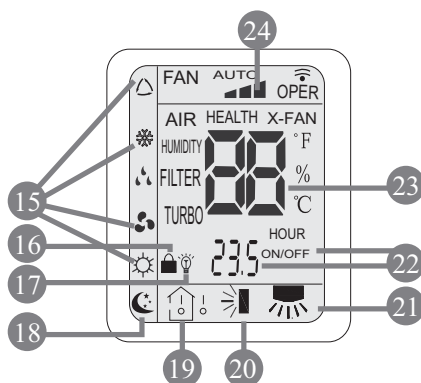

## 6.Function and Control

### 6.1 Remote Control Operations



- 1 ON/OFF**  
Press it to start or stop operation.
- 2 MODE**  
Press it to select operation mode (AUTO/COOL/DRY/FAN/HEAT).
- 3 -**  
Press it to decrease temperature setting.
- 4 +**  
Press it to increase temperature setting.
- 5 FAN**  
Press it to set fan speed.
- 6**   
Press it to set swing angle.
- 7 HEALTH SAVE**  
Press it to turn on or off health function.
- 8**   
Press it to set left & right swing angle.
- 9 X-FAN**(X-FAN is the alternative expression of BLOW for the purpose of understanding.)
- 10 TEMP**
- 11 TIMER**  
Press it to set timer ON/ timer OFF.
- 12 TURBO**
- 13 SLEEP**
- 14 LIGHT**  
Press it to turn on/off the light.



- 15 MODE icon:**  
If MODE button is pressed, current operation mode icon  $\triangle$  (AUTO),  (COOL),  (DRY),  (FAN) or  (HEAT is only for heat pump models) will show.
- 16 LOCK icon:**  
 is displayed by pressing "+" and "-" buttons simultaneously. Press them again to clear the display.
- 17 LIGHT icon:**  
 is displayed by pressing the LIGHT button. Press LIGHT button again to clear the display.
- 18 SLEEP icon :**  
 is displayed by pressing the SLEEP button. Press this button again to clear the display.
- 19 TEMP icon:**  
Pressing TEMP button,  $\hat{\square}$  (set temperature),  $\hat{\square}$  (ambient temperature),  $\hat{\square}$  (outdoor ambient temperature) and blank is displayed circularly.

**20 Up & down swing icon:**

 is displayed when pressing the up & down swing button. Press this button again to clear the display.

**21 Left & right swing icon:**

 is displayed when pressing the left & right swing button. Press this button again to clear the display.

**22 SET TIME display:**

After pressing TIMER button, ON or OFF will blink. This area will show the set time.

**23 DIGITAL display:**

This area will show the set temperature. In SAVE mode, "SE" will be displayed. During defrosting operation, "H1" will be displayed.

**24 FAN SPEED display:**

Press FAN button to select the desired fan speed setting (AUTO, Low, Med, High). Your selection will be displayed in the LCD windows, except the AUTO fan speed.

**Remote controller description**

**1 ON/OFF:**

Press this button to turn on the unit. Press this button again to turn off the unit.

**2 MODE:**

Each time you press this button, a mode is selected in a sequence that goes from AUTO, COOL, DRY, FAN, and HEAT \*, as the following:



\*Note: Only for models with heating function.

After energization, AUTO mode is defaulted. In AUTO mode, the set temperature will not be displayed on the LCD, and the unit will automatically select the suitable operation mode in accordance with the room temperature to make indoor room comfortable.



**3 + :**

Press this button to increase set temperature. Hold it down for above 2 seconds to rapidly increase set temperature. In AUTO mode, set temperature is not adjustable.

**4 -:**



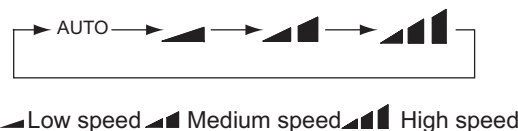

Press this button to decrease set temperature. Hold it down for above . 2 seconds to rapidly decrease set temperature. In AUTO mode, set temperature is not adjustable.

**5 FAN :**

This button is used for setting fan speed in the sequence that goes from AUTO, , ,  to then back to Auto.



**6 **

- Press  button to start or stop up & down swing function. The remote controller defaults to simple swing condition.
- Press + button and  button at the same time at unit OFF to switch between simple swing and static swing;  blinks for 2 seconds.
- In static swing condition, pressing  button, the swing angle of up & down louver changes as below:

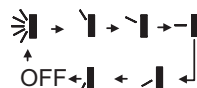



• If the unit is turned off during swing operation, the louver will stop at present position.

**7 HEALTH|SAVE:**

Press HEALTH part of this button to turn on or off HEALTH function. Pressing SAVE part of this button, "SE" is displayed and the unit goes into SAVE operation mode. Press SAVE part of the button again to cancel SAVE function. During SAVE operation, the temperature and fan speed is not adjustable.

**8 **

- Press  button to start or stop left & right swing function. The remote controller defaults to simple swing condition.
- Press + button and  button at the same time at unit OFF to switch between simple swing and static swing;  blinks for 2 seconds.



- In static swing condition, pressing  button, the swing angle of left & right louver changes as below:



- If the unit is turned off during swing operation, the louver will stop at present position.

**9 X-FAN:**

Pressing X -FAN button in COOL or DRY mode, the icon "X-FAN" is displayed and the indoor fan will continue operation for 10 minutes in order to dry the indoor unit even though you have turned off the unit. After energization, X-FAN OFF is defaulted. X-FAN is not available in AUTO, FAN and HEAT mode.

**10 TEMP:**

Press this button, could select displaying the indoor setting temperature or indoor ambient temperature. When the indoor unit firstly power on it will display the setting temperature, if the temperature's displaying status is changed from other status to "  ", displays the ambient temperature, 5s later or within 5s, it receives other remote control signal that will return to display the setting temperature. if the users haven't set up the temperature displaying status, that will display the setting temperature.

**11 TIMER:**

Press TIMER button at unit ON to set TIMER OFF; HOUR OFF blinks. Press TIMER button at unit OFF to set TIMER ON; HOUR ON blinks. In this case, pressing + or - button changes time setting. Holding down either button rapidly changes time setting (time setting range 0.5-24hours). Press TIMER button again to confirm setting; HOUR ON/OFF stops blinking. If there is not any operation of button within 5 seconds during HOUR ON/OFF blinking, TIMER setting will be cancelled.



**12 TURBO:**

Press this button to activate / deactivate the Turbo function which enables the unit to reach the preset temperature in shortest time. In COOL mode, the unit will blow strong cooling air at super high fan speed. In HEAT mode, the unit will blow strong heating air at super high fan speed.



**13 SLEEP :**



Press this button to go into the SLEEP operation mode. Press it again to cancel this function. This function is available in COOL , HEAT (Only for models with heating function) or DRY mode to maintain the most comfortable temperature for you.

**14 LIGHT:**

Press LIGHT button to turn on the display's light and press this button again to turn off the display's light. If the light is turned on ,  is displayed. If the light is turned off,  disappears.

**15 Combination of "+" and "-" buttons: About lock**

Press "+" and "-" buttons simultaneously to lock or unlock the keypad. If the remote controller is locked,  is displayed. In this case, pressing any button,  blinks three times.

**16 Combination of "MODE" and "-" buttons: About switch between Fahrenheit and Centigrade. At unit OFF, press "MODE" and "-" buttons simultaneously to switch between  and .**

**Replacement of Batteries**

1. Remove the battery cover plate from the rear of the remote controller. (As shown in the figure)
2. Take out the old batteries.
3. Insert two new AAA1.5V dry batteries, and pay attention to the polarity.
4. Reinstall the battery cover plate.

**Notes:**

- When replacing the batteries, do not use old or different batteries, otherwise, it may cause malfunction.
- If the wireless remote controller will not be used for a long time, please remove batteries to prevent damage from leaking batteries.
- The operation should be performed in its receiving range.
- It should be kept 1m away from the TV set or stereo sound sets.
- If the wireless remote controller does not operate normally, please take the batteries out and reinsert them after 30 seconds. If it still can't operate properly, replace the batteries.

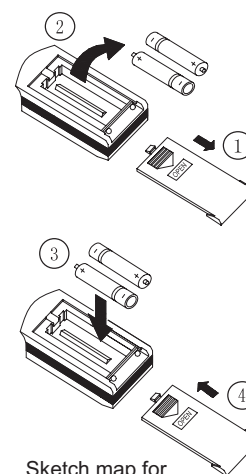

Sketch map for replacing batteries

## 6.2 Function Buttons of Air Conditioner

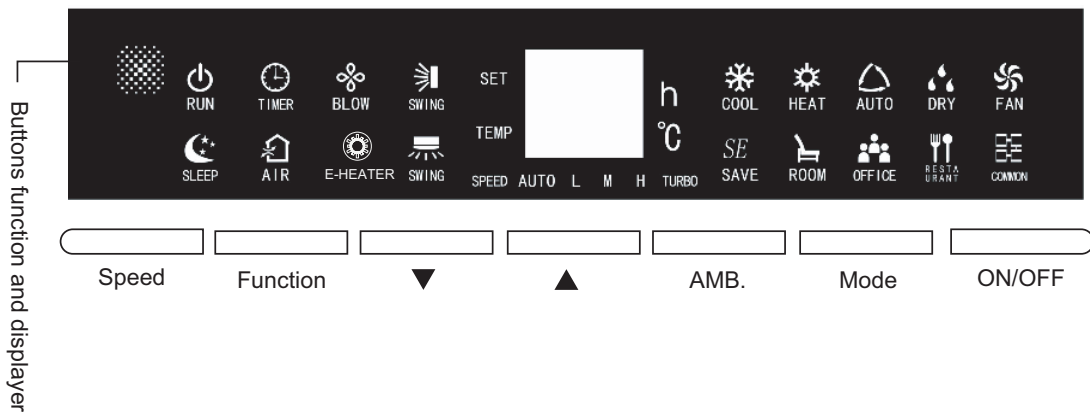

**ON/OFF**

**ON/OFF Button**

- Press this button, to turn on the unit. When unit is turned on, the original setting like Timer, Sleep function will be canceled. Note: When the unit is running in Dry mode, press ON/OFF button that can turn on the unit directly.
- When the unit start up running, the status light will display in red indicated as power turn-on and free-duty.

**Mode**

**Mode Button**

- Press the button, the circulating changes of mode are shown as below:

```

    graph LR
      AUTO --> COOL
      COOL --> DRY
      DRY --> FAN
      FAN --> HEAT
      HEAT --> AUTO
  
```

AUTO: the controller will determine its operation mode according to changes of room temperatures under this mode.  
 COOL: display cooling state.  
 DRY: reduce temperature and keep the setting room temperature without any change.  
 FAN: The compressor doesn't on work and only the indoor blower is on running under this mode.  
 HEAT: Display the state of heating .  
 (Note: Single-cooling machine is not equipped with heating mode)

**▲ and ▼ Button**

- Under the situation without setting the function, press ▲ and ▼ buttons, the setting temperature goes up and down 1°C, the regulating range is from 16°C to 30°C.
- Under the conditions of setting the functions, can proceed with the round-trip option of this function (set ▲ and ▼ opposite direction of circulation).
- Keep pressing ▲ and ▼ buttons for 3 seconds continuously, functions of all buttons on the display panel will be conductively-closed, and then press any button, the buzzer will ring once while "LC" is flashing for three times on the location of double 8 and resume to normal display so as to prompt users that the buttons have been locked up. When keep pressing again the two buttons for another 3 seconds continuously, the function of lockup will be removed and resume to display in normal state.

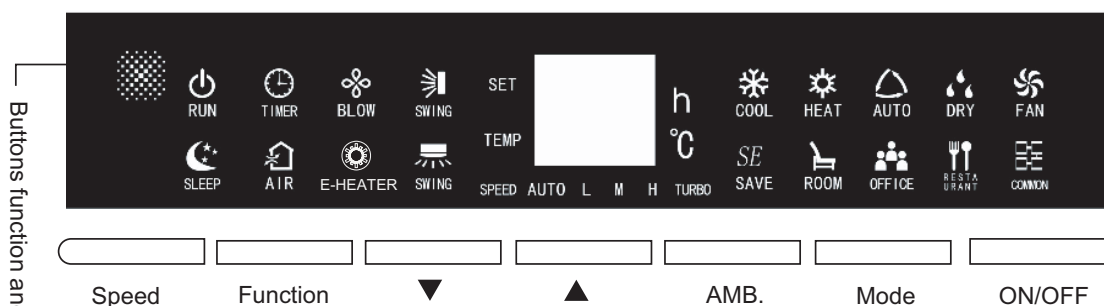

Buttons function and displayer

▲ and ▼

▲ and ▼ Buttons (Continued)

- After switch-on at first time, if without any button input: 1. consecutively press twice of ▲ buttons in 20 seconds and soon access to the running of forced heating. After the blades of blowing up and down opens to the minimum position, start up running of all loads, indoor and outdoor high-speed blowers. All characters will be displayed when the non-inductive thermometer bulb is broken down. The fault codes of breakdown will be displayed when the inductive thermometer bulb is broken down and then the buzzer rings. After shutdown for five minutes or receiving shutdown signal within 5 minutes, it enter the status of normal standby. 2. consecutively press twice of ▼ buttons in 20 seconds and soon access to the running of forced cooling. After the blades of blowing up and down opens to the minimum position, start up running of all loads, indoor and outdoor high-speed blowers besides the four-way valve and then the buzzer rings. After shutdown for five minutes or receiving shutdown signal within 5 minutes, it enter the status of normal standby. The 1 and 2 Functions are for trial use only.

Speed

Speed Button

- Press this button, the speed can shift in the circulation among of “ Auto → Low → Medium → High → Super → Auto ”  
Note: the function of forced low speed under operation of dehumidification is not available.

AMB.

AMB. Button

- Press this button, AMB. circulating changes set forth below:
 

→ Energy saving → Living Room →  
 ← Normal ← Restaurant ← Conference/Office ←
- Adjustable method of AMB.  
Button: The switch-on of AMB. mode at first time is the default of normal mode, when shutting down and starting up again, the AMB. mod will keep the setting status before last shutting down. Under the modes of energy-saving, conference/office and restaurant, the sleep function will be automatically cancelled. And the sleep function is not adjustable: sleep function is only available on service for cooling, dehumidification and heating under normal mode.

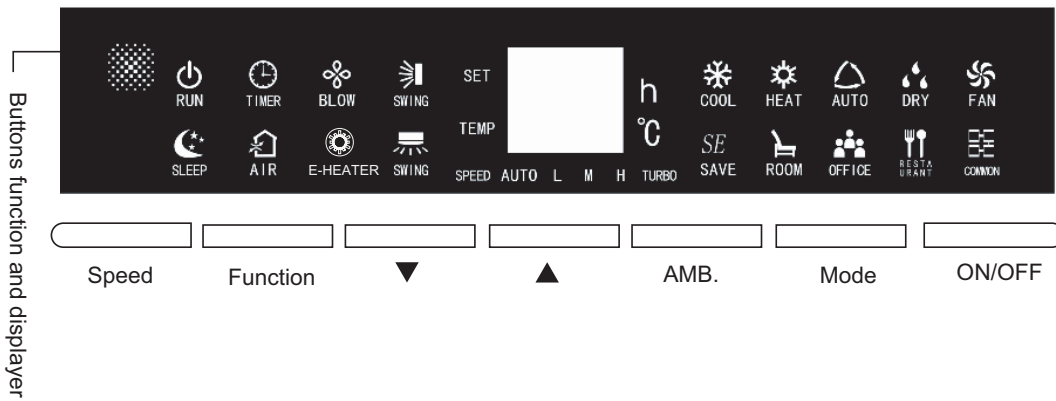

AMB.

AMB. Buttons (Continued)

- Under the modes of living room, restaurant, conference/office, The setting temperature, speed, blowing up and down as well as left and right can be adjustable. If users change the setting temperature, speed, blowing up and down as well as left and right, the operation will run in accordance with the status of setting adjustment. The services setting of blowing up and down as well as left and right of next time start-up will be remained before last shutdown while the setting temperature and speed will run with the default.
- Under the energy-saving mode, while the heating service is on running, the setting temperature, speed, blowing up and down as well as left and right can be adjustable. If users change the setting speed, blowing up and down as well as left and right, it will run according the status of users' setting adjustment. But the setting temperature under the energy-saving cooling function can not be adjusted.

AMB.

AMB. Buttons (Continued)

- The modes of living room, restaurant, conference/office can only be called out by pressing buttons of air conditioner panel. If receiving the signal from remote control when the air conditioner is running the modes of living room, restaurant, conference/office, it will exit from the above-mentioned modes and run according to the modes of remote control.

Function

Function Button

- Under the status of switch-on, Every time press the function button, the settings of up and down, left and right, drying, concurrent heating, timing, air renewal, setting and room temperature can be shifted in sequence. When a certain character is flashing, it indicates can proceed its setting and go on setting by press buttons. The action will be confirmed if without receiving other operating order in 5 seconds. Or press the function button to leave for the confirm.
- Press the function button under the status of running drying service can directly proceed shutdown. Press the function button under the status of shutdown and non-drying can proceed timing setting.

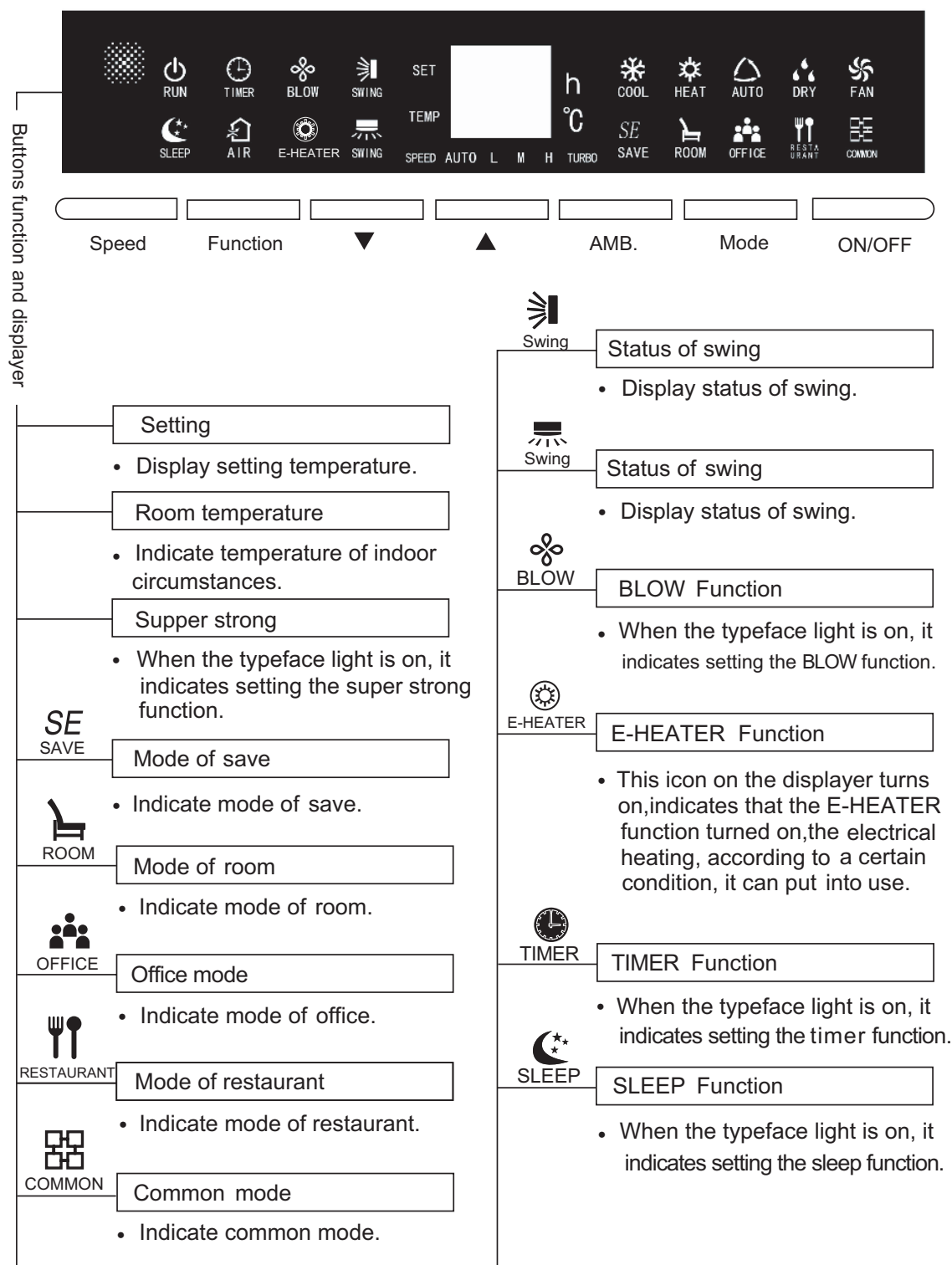

## 6.3 Description of Each Control Operation

### 1. Running Mode

1. cooling; 2. dry; 3. fan; 4: heating; 5. AUTO; 6. others (Freon recovery mode).

### 2. Temperature Parameter

1. Indoor ambient temperature  $T_{amb}$ . (adopt 15K temperature sensor, external connect 15K partial resistance);
2. Outdoor ambient temperature  $T_{outdoor\ amb}$ . (adopt 15K temperature sensor, external connect 15K partial resistance);
3. Discharge temperature ( $T_{discharge}$ )
4. Indoor evaporator tube temperature  $T_{evaporator}$  (adopt 20K temperature sensor, external connect 20K partial resistance);
5. Outdoor condenser tube temperature  $T_{condenser}$  (adopt 20K temperature sensor, external connect 20K partial resistance).

### 3. Basic Functions of System

In all modes, once the compressor is started up, it will run within 6mins all the time; once the compressor is stopped, it can only be started up after 3mins delayed.

#### (1) Cooling Mode

##### 1. Working conditions and process of cooling

When  $T_{amb} \geq T_{preset} + 1^\circ\text{C}$ , the unit will run in cooling mode. Meanwhile, compressor, outdoor fan will start running, and indoor will run at setting fan speed;

When  $T_{amb} \leq T_{preset} - 1^\circ\text{C}$ , the unit is at OFF status in cooling mode. Meanwhile, compressor, outdoor fan will all stop running, while indoor fan will run at setting fan speed;

When  $T_{preset} - 1^\circ\text{C} < T_{amb} < T_{preset} + 1^\circ\text{C}$ , the unit will keep previous running status.

➤ In this mode, the temperature setting range is  $16^\circ\text{C} \sim 30^\circ\text{C}$  and the initial value is  $25^\circ\text{C}$ .

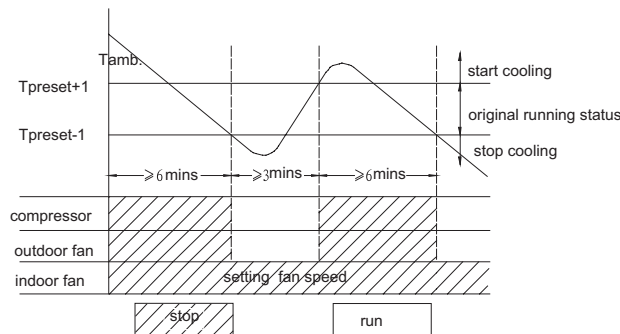

#### (2) Dry Mode

##### 1. Working conditions and process of dry

When  $T_{amb} > T_{preset} + 2^\circ\text{C}$ , the unit will run in cooling mode. Meanwhile, compressor and outdoor fan will start running, and indoor fan will run at low fan speed;

When  $T_{preset} - 2^\circ\text{C} \leq T_{amb} \leq T_{preset} + 2^\circ\text{C}$ , compressor and outdoor fan will run for 6mins and then stop for 4 mins, and they will run like that circularly. Indoor fan will run at low fan speed;

When  $T_{amb} < T_{preset} - 2^\circ\text{C}$ , compressor and outdoor fan will stop running, while indoor fan will run at low fan speed.

➤ In this mode, the temperature setting range is  $16^\circ\text{C} \sim 30^\circ\text{C}$  and the initial value is  $25^\circ\text{C}$ .

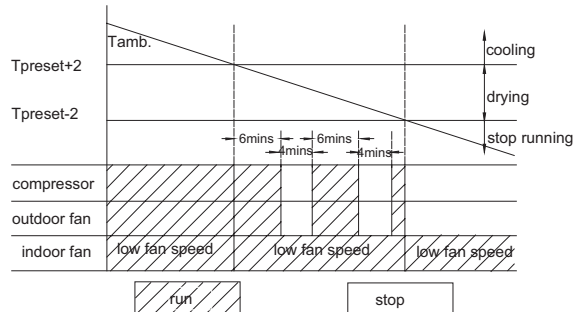

(3) Heating Mode (this mode is not available for cooling only unit)

1. Working condition and process for heating

When  $T_{amb} \leq T_{preset}-1^{\circ}C$ , the unit will run in heating mode. Meanwhile, compressor and outdoor fan will start running. Indoor fan may be start running after delayed for a period of time to prevent blowing out cold air. If the unit turns to heating mode for the first time or switches to heating mode from other modes, the four-way valve will be energized after compressor was started up for the first time for 20s.

When  $T_{amb} \geq T_{preset}+1^{\circ}C$ , compressor and outdoor fan will stop running. The four-way valve is energized all the same and indoor fan will stop running after running at low fan speed for 10s;

When  $T_{preset}-1^{\circ}C < T_{amb} < T_{preset}+1^{\circ}C$ , the unit will keep original running status;

- In this mode, the temperature setting range is  $16^{\circ}C \sim 30^{\circ}C$  and the initial value is  $25^{\circ}C$ . When tuning off the unit in heating mode or switching to other modes from heating mode, the four-way valve will be de-energized after 2mins delayed.
- When turning off the unit, if the complete unit is at running status in heating mode, the unit will stop running when reaching the setting temperature and the unit will be turned off after blowing residual heat for 10s. If the unit is at the status of blowing residual heat when the unit is stopped after reaching the temperature point, the unit will continue to blow residual heat and then it will be turned off; if the unit is stopped after reaching the temperature and indoor fan is stopped, the unit will be turned off directly without blowing residual heat.

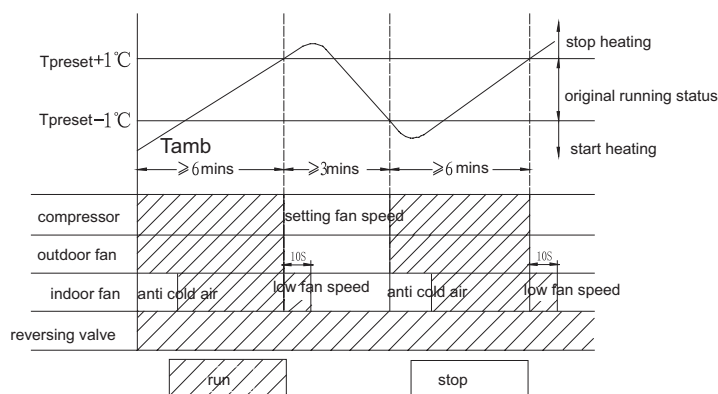

2. Defrosting condition and process

System will defrost intelligently and automatically. When it's detected that the system is reached the defrosting condition, the system will turn to defrosting status;

After defrosting is started up, H1 will be displayed. If there's auxiliary heating, auxiliary heating will be stopped and then compressor, indoor fan and outdoor fan will stop running after 1min delayed. 3mins later, the four-way valve will be closed. After four-way valve has closed for 30s, compressor will be started up.

After defrosting is finished, compressor will stop running, while the four-way valve will be start up. 30s later, compressor and outdoor fan will be restarted up and turn to the next periods. Indoor fan is running at anti cold air status.

Defrosting time can't exceeds 12mins at the most.

3. Working condition for auxiliary heating

Auxiliary heating can be turned on/off by buttons.

If auxiliary heating is at ON status, when indoor fan is running, and indoor ambient temperature and air discharge temperature are low, auxiliary heater will start running;

When indoor fan isn't running, or indoor ambient temperature is high, or air discharge temperature is high, auxiliary heater will stop running. Once the auxiliary heater is stopped, it can only be restarted up after 2mins delayed.

If auxiliary heating is set OFF, the auxiliary heating will be turned off directly.

(4) Fan Mode

Indoor fan is running at setting fan speed: auto fan speed → low fan speed → medium fan speed → high fan speed

- The temperature setting range is  $16^{\circ}C \sim 30^{\circ}C$  and the initial value is  $25^{\circ}C$ .

(5) Auto Mode

In this mode, the system will select the running mode (cooling, dry, heating, fan) automatically according to the change of ambient temperature.

- Once the mode is started up, the unit will only switch to the running status under auto mode according to  $T_{amb}$  after it has run for 30s at least.

( 6 ) Freon Recovery Mode

That's the recovery operation method for refrigerant:

1. After the A/C is energized for the first time, set the A/C at FAN mode, low fan speed by remote controller and the indoor temperature is set as 20°C; Meanwhile, indoor fan will start running.
2. Press the light button on remote controller for twice successively within 5s; meanwhile, indoor fan and compressor will start running automatically.
3. After compressor has run for 3mins, close the cut-off valve completely.
4. When the protector for low-voltage switch has an action, compressor and outdoor unit will stop running automatically. Please close the cut-off valve immediately.
5. After stopping blowing wind by remote controller, the refrigerant recovery operation is finished completely.

Notice: 1. After refrigerant is recovered, if the recovery operation should be operated again, please cut off the power at first and then put through the power again.

2. Above methods are applicable for the movement or reinstallation of indoor unit or outdoor unit; during this process, the low voltage switch can't be short circuited.

4. Other Controls

1. Sleep Function

Sleep in cooling mode:

When initial temperature is set as 16~23°C, after sleep function is started up, the temperature will increase by 1°C every 1hr. After the temperature has increased by 3°C, the unit will keep this temperature. After the unit has run for 7hrs, the temperature will decrease 1°C and then the unit will run at this temperature all the time.

When initial temperature is set as 24~27°C, after sleep function is started up, the temperature will increase by 1°C every 1hr. After the temperature has increased by 2°C, the unit will keep this temperature. After the unit has run for 7hrs, the temperature will decrease 1°C and then the unit will run at this temperature all the time.

When initial temperature is set as 28~29°C, after sleep function is started up, the temperature will increase by 1°C every 1hr. After the temperature has increased by 1°C, the unit will keep this temperature. After the unit has run for 7hrs, the temperature will decrease 1°C and then the unit will run at this temperature all the time.

When initial temperature is set as 30 °C, the unit will run at this temperature. After the unit has run for 7hrs, the temperature will decrease by 1°C and then the unit will run at this temperature all the time.

Sleep in heating mode:

When initial temperature is set as 16°C, the unit will run at this temperature all the time;

When initial temperature is set as 17~20°C, after sleep function is started up, the temperature will decrease by 1°C every 1hr. After the temperature has decreased for 1°C, the unit will keep this temperature.

When initial temperature is set as 21~27°C, after sleep function is started up, the temperature will decrease by 1°C every 1hr. After the temperature has decreased for 2°C, the unit will keep this temperature.

When initial temperature is set as 28~30°C, after sleep function is started up, the temperature will decrease by 1°C every 1hr. After the temperature has decreased for 3°C, the unit will keep this temperature.

Sleep in dry mode:

When setting sleep function in dry mode, after the sleep function has run for 1hr, Tpreset will increase by 1°C and it will increase by another 1°C after 2hrs. Tpreset will increase by 2°C at all within 2hrs and then the unit will run at this temperature.

Sleep in fan mode and auto mode:

Sleep function is nor available in fan mode and auto mode.

2. Timer Function

Timer ON: Timer ON can be set at the OFF status of the unit. After timer ON is reached, controller will run according to the setting mode. The time setting range is 0.5~25hrs and the interval is 0.5hr. If the time on display screen is less than 10hrs, the display interval is 0.5hr; if the time is more than 10hrs, the display interval is 1hr.

Timer OFF: Timer OFF can be set at the ON status of the unit. After timer OFF is reached, the unit will be turned off. The time setting range is 0.5~25hrs and the setting interval is 0.5hr. If the time on display screen is less than 10hrs, the display interval is 0.5hr; if the time is more than 10hrs, the display interval is 1hr.

3. Swing Control

Swing motor can be turned on/off by pressing the swing button on remote controller. Swing is valid only when the indoor fan is running.

Right & left swing: swing blade has 7 kinds of status: ① angle 1, ② angle 2, ③ angle 3, ④angle 4, ⑤ angle 5, ⑥ swing, ⑦ stop. After the unit is turned on by the ON/OFF button on control panel every time, the default status of swing is OFF and the position is ③ angle 3. After the unit is turned on by remote controller, the status of swing motor is basing on the display status on remote controller. After the unit is energized every time, right & left swing motor will be reset.

UP & down swing: when turning off the unit, the swing blade will stop at the starting point (zero position). When turning on the unit, there are 7 kinds of status: ① angle 1 (max position), ② angle 2, ③angle 3, ④angle 4, ⑤angle 5 (min position), ⑥swing, ⑦stop. If turn on the unit by the ON/OFF button on control panel, the setting swing status is basing on the status before turning off the unit; while if turn on the unit by remote controller, the setting swing status is basing on the status on remote controller (if the receiving remote controller is 35, 25, 24, 14 or 13, it's ⑥ swing). When turning on the unit each time (including turn on the unit by remote controller or control panel), if the setting swing status is not ⑦stop, then it will at the actual swing status; if the setting swing status is ⑦stop, after turning the unit, it will be defaulted at angle 3 in cooling, angle 4 in heating and angle 3 in dry. As for mode switchover, it will also switch like that until the setting swing status is not ⑦stop, then the above compulsory default status will be cancelled.

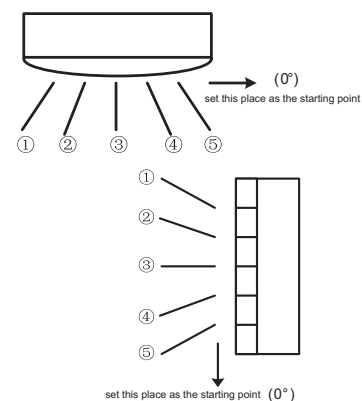



When turning on the unit each time, the swing blade must be open to angle 5 (mini position), and then compressor, fan etc. can run. When switching on controller or turning off the unit each time, the swing blade must be at OFF status.

#### 4. Buzzer

Upon energization or operation, the buzzer will give out pleasant sound (digital chord).

#### 5. Auto Fan Speed Control of Indoor fan

In auto fan speed, indoor fan will select high, medium or low fan speed automatically according to the change of ambient temperature. For the switchover between any two kinds of fan speed, the unit must be make sure that it has run at each fan speed for 3mins and 30s at least.

#### 6. AIR Function (it's reserved for some models)

AIR function is invalid when the unit is turned off. Upon receiving the order for starting up AIR function from remote controller or control panel, indoor fan will be turned on and the AIR function will be started up; once receiving the order for turning off AIR function, AIR function will be turned off. After the unit is turned off, AIR function will be cleared automatically.

#### 7. X-FAN function

X-FAN function can be turned on/off by the FUNCTION button on control panel or X-FAN E-HEATER button on remote controller.

If start up X-FAN function in cooling or dry mode, after the unit is turned off, indoor unit will still run for a few minutes to dry the water inside the unit, and then the indoor unit will be turned off automatically.

#### 8. Turbo Function

In cooling and heating mode, turbo function can be turned on/off (there's no turbo function in auto, dry and fan mode) by the turbo button. After pressing turbo button for once, remote controller will display the characters of "turbo" and fan speed won't change. Meanwhile, indoor fan will run at super-high fan speed and display panel will display the super-high fan speed; After repressing turbo button, the turbo function will be quitted and the characters of "turbo" on remote controller will be disappeared. Meanwhile, indoor fan will turn back to setting fan speed. Super-high fan speed will also be quitted after operating the fan speed button and the fan speed will also be changed correspondingly. Display panel will display the setting fan speed.

Turbo function is default to be turned off when remote controller is energized.

When restarting up the unit or switching the mode, turbo function will be memorized.

When restarting up the unit by remote controller and controller or switch to cooling or heating mode, turbo function will be memorized.

While when switching to auto, dry or fan mode, the turbo function is unavailable.

#### 9. Power-off Memory Function

When re-energizing the unit after power failure, the unit will run at the memory content. Memory content : mode, up&down swing (7kinds of status), right and left swing (7 kinds of status), setting temperature, setting fan speed, light, timer, turbo, AIR, health and environment mode.

If the unit is at ON status after power failure, compressor will be started up 3mins delayed after energization; if the unit is at OFF status, compressor will be started up without 3mins delayed.

If the timer hasn't been reached before power failure, the unit will time again according to the setting timer before power failure.

## 5 Protective Measures

### 1. Indoor antifreezing protection

When cooling in cooling mode or dry mode (that's  $T_{amb} > T_{preset} + 2^{\circ}\text{C}$ ), if it's detected that the evaporator tube temperature is too low the system will turn to antifreezing protection status. Meanwhile, compressor and outdoor fan will stop running, while indoor fan and swing motor will keep original status. When evaporator tube temperature resumes to normal range and compressor has stopped for 6mins, controller will run at the setting mode.

Buttons won't be shielded during the antifreezing protection.

### 2. High-pressure protection of system

When the high-pressure protection is detected for 3s successively, all loads will be turned off. Meanwhile, all buttons and signal will be shielded and E1 will be displayed. When it's detected that the high-pressure protection of compressor has been released for 6s successively, the shield for button and signal will be released and E1 will still be displayed. E1 can be cleared after pressing ON/OFF button to turn off the unit. The unit will resume running after repressing ON/OFF button.

### 3. Low-voltage protection of system

This function is unavailable for some modes. But if the controller is the general controller and the shielded wire of low-pressure protection is loosened or not connected well, it will take it as low-pressure protection by mistake. The details are as below:

1. After compressor is started up for 2mins, it will begin to detect the signal of low pressure switch. If it's detected that the low pressure switch is broken for 1mins successively, the complete unit will stop running. 3mins later, if the low pressure switch is resumed, the unit will resume running automatically. If low pressure switch protection occurs for 2 times successively, E3 will be displayed and the can't resume running automatically to warn users that it's leaking. After restarting up the unit and low pressure switch is resumed, the unit will resume running.

2. When compressor is stopped, if it's detected that the low pressure switch is broken for 30s successively, the complete unit will stop running. Meanwhile, E3 will be displayed and the unit can't resume running automatically. Only after restarting up the unit and the low pressure switch is resumed, the unit can resume sunning.

3. When compressor hasn't been start up after energization each time, if it's detected that the low pressure switch is broken for 1s successively, all loads won't be turned on after turning on the unit, and E3 will be displayed on the display screen. E3 will still be displayed after restarting up the unit. Only when the low pressure switch is resumed, E3 will be cleared and then all loads will run normally.

4. In compulsory cooling or heating mode, it will begin to detect the signal of low pressure switch after compressor has started up for 2mins. When it's detected that the low pressure switch is broken for 1s successively, the complete unit will stop running and E3 will be displayed. During compulsory heating, if outdoor ambient temperature  $\leq 0^{\circ}\text{C}$ , the detection for low pressure switch will be shielded.

Correct disposal method: after cutting off the power, insert the shielded wire again to make sure that the shielded wire is connected firmly and then restart up the unit.

#### 4. High temperature protection for discharge pipe

After the compressor is started up, if it's detected that the discharge temperature is too high for 30s successively, the unit will stop running when indoor ambient temperature is reached to setting temperature. When compressor has stopped for 3mins and discharge temperature resumes to normal range  $T_{\text{discharge}} < 90^{\circ}\text{C}$ , the complete unit will resume running.

If above protection is occurred for twice successively, the complete unit can't resume running and E4 will be displayed. When restarting up the unit and  $T_{\text{discharge}} < 90^{\circ}\text{C}$ , the unit will run at setting mode.

If turning on the unit to turn to heating mode or switching to heating mode from other modes, discharge protection will be shielded for 1min when compressor is started up for the first time.

#### 5. Indoor high temperature resistance protection

In heating mode, when it's detected that the evaporator tube temperature is too high, outdoor fan will stop running; when evaporator tube temperature resumes to normal range, outdoor fan will be started up.

#### 6. Overcurrent protection

After compressor is started up, if it's detected that the current is exceeds  $I_0 (I_0=25\text{A})$  for 3s successively, the unit will stop running when Indoor ambient temperature is reached to setting temperature. After compressor has stopped for 3mins, the unit will resume original running status. If protection times exceeds 6 times, indicator will blink and display E5 and the unit can't resume original running status. The unit can only resume running after restarting up the unit.

#### 7. Malfunction of temperature sensor

Under ON status, it will detect the malfunction of indoor tube temperature (exclude defrosting period and the period when defrosting is finished for 5mins) and outdoor discharge temperature sensor (in heating mode, it starts detecting the malfunction after compressor has started up for 1min; the malfunction won't be detected when compressor is stopped). It's the malfunction when they are short circuit or broken circuit for 30s successively. When there's malfunction of temperature sensor, the complete unit will stop running. Meanwhile the indicator will blink and display the corresponding error code. Malfunction of temperature sensor won't shield the button and remote controller.

#### 8. Malfunction and protection code

E1: high-pressure protection of system;

E3: low-pressure protection of system;

E4: high temperature protection for discharge pipe;

E5: overcurrent protection;

F1: malfunction of indoor ambient temperature sensor;

F2: malfunction of indoor tube temperature sensor;

F3: malfunction of outdoor ambient temperature sensor

F4: malfunction of outdoor tube temperature sensor

F5: malfunction of discharge temperature sensor

When multiple malfunctions are occurred simultaneously, each malfunction error will be displayed for 3s and they be will displayed in cycle.

## 6 Button

When remote controlling by remote controller:

1.If the display mode for remote controller is the heating mode and A/C is the cooling only type, A/c won't receive other signal except the signal for turning off the unit.

2.If pressing the invalid button on remote controller, the buzzer will still give out a sound but the function won't be carried out.

There are those buttons on the panel: ON/FF button, mode button, ambient setting button, ▲ button, ▼ button, function button, fan speed button.

Display screen:

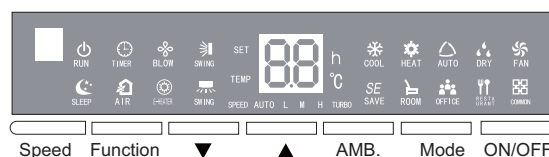

### 1. ON/OFF button

Controller is turned on/off by pressing this button. After each pressing of this button, the on/off status will be switched for once.

### 2. Mode button

After pressing this button, it will be selected and displayed as below:

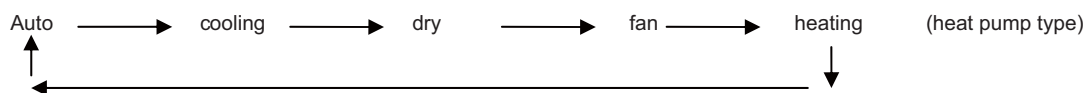

### 3. Ambient setting button

After pressing AMB. button, it will be selected as below:

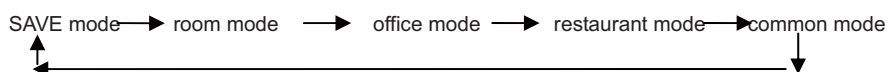

① In each mode, after pressing AMB. mode on control panel, the ambient mode can be selected and cycled as : SAVE mode---room

mode---office mode---restaurant mode---common mode; when the unit is turned on for the first time, ambient mode is default as common mode; when restarting up the unit, ambient mode will keep the setting status before turning off the unit.

② When using the remote controller, the unit can only turn to SAVE mode or common mode after receiving the order from remote controller, and the unit will run according to the order transmitted by remote controller all the time.

③ In SAVE mode, room mode, office mode or restaurant mode, sleep will be cancelled automatically and sleep can't be adjusted; Sleep is only valid in cooling, dry and heating mode under the common mode.

④ Room, restaurant and office modes

Cooling and heating mode: setting temperature, fan speed and swing will run at the default status. If users have adjusted the parameters, they will run according to adjusting status. 30mins later, it will turn back to auto adjusting status; when restating the unit, swing will keep the status before turning off the unit.

Fan, dry and auto mode: running status is the same as that in common mode.

⑤ SAVE mode

In cooling mode: setting temperature and fan speed can be adjusted automatically; if users have adjusted the setting temperature and setting fan speed, it will run according to the adjusting status. 30mins later, it will turn back to auto adjusting status.

Heating, fan, dry and auto mode: the running status is the same as that in common mode.

Notice: room, restaurant and office mode can only be adjusted by buttons on control panel. If controller is receiving the order from remote controller when it's running in room, restaurant or office mode, those modes will be quitted and it will run according to the mode on remote controller.

### 4. Selection button for setting temperature ( ▲ and ▼ )

(1) During the status when don't set the function, after pressing ▲ button or ▼ button for once, the setting temperature will increase or decrease for 1℃ and the temperature setting range is 16℃~30℃.

(2) During the status when setting the function, the function can be selected circularly. (the circulatory direction for ▲ and ▼ is opposite)

① up & down (swing): swing, stop swinging.

② right & left (swing): swing, stop swinging.

③ blow: start up blow, turn off blow.

④ E-HEATER: start up E-HEATER, turn off E-HEATER.

⑤ TIMER: set timer and it can be adjusted among 0~24hrs. If the time is less than 10hrs, the interval is 0.5hr; if the time is more than 10hrs, the interval is 1hr.

⑥ AIR: start up AIR, turn off AIR.

⑦ Sleep: start up sleep, turn off sleep.

⑧ Health: start up the electrostatic dedusting, turn off the electrostatic dedusting.

⑨ Turbo: start up turbo, turn off turbo.

- ⑩ Setting: default to display the setting temperature at ON status, default to display the setting temperature at off status
  - ⑪ Room temperature: default to display room temperature at on status, default to display to room temperature at off status.
  - (3) After pressing ▲ button and ▼ button simultaneously, all buttons on the display panel will be shielded. When pressing any buttons, the buzzer will give out a sound and dual 8 will display "LC". The display will resume normal after the dual 8 blinks 3 times to warn users that the buttons are locked. When repressing those two buttons simultaneously, shield will be released and the display will resume normal status.
  - (4) After the unit is energized for the first time, if there isn't any input:
    - ① If pressing ▲ buttons within 20s successively, the unit will turn to compulsory heating immediately and up & down swing blade will open to angle I (minimum position). Meanwhile, all loads will be started up and indoor fan and outdoor fan will run at high fan speed. When there's no malfunction of temperature sensor, all characters will be displayed. When there's malfunction of temperature sensor, dual 8 will display error codes circularly and the buzzer will give out sound. When the unit is stopped 5 mins later or the unit is stopped after receiving the signal for turning off the unit within 5mins, the unit will turn to normal standby status.
    - ② If pressing ▼ button within 20s successively, the unit will turn to compulsory cooling immediately and up & down swing blade will open to angle I (minimum position). Meanwhile, all loads will be turned on except the four-way valve and the indoor fan and outdoor fan will run at high fan speed. When there's no malfunction of temperature sensor, all characters will be displayed. When there's malfunction of temperature sensor, dual 8 will display error codes circularly and the buzzer will give out sound. When the unit is stopped 5 mins later or the unit is stopped after receiving the signal for turning off the unit within 5mins, the unit will turn to normal standby status.
- After above tests are all displayed for 2s, it will begin to detect the malfunction of indoor ambient, indoor tube temperature, outdoor ambient, outdoor ambient, outdoor tube temperature and discharge temperature sensor. When it's detected that there are multiple malfunctions, each error code will be displayed for 3s and they will be displayed circularly.
- Item ① and ② are only used for testing. During this period, high pressure, overcurrent and discharge protection won't be detected.

5. Function button

In the ON state of the unit, after each pressing of the function button, you can switch among up&down swing, right&left swing, blow, E-HEATER, timer, AIR, sleep, health (this is unavailable for L-shape floor standing A/C), turbo, setting and room temperature setting in sequence. When a certain character is blinking, it means that you can set this function and you can press "▲" button or "▼" button to set it. The setting will be confirmed after the setting has been set for 5 mins and there's no change for the operation.

In blow running status, the unit will be turned off after pressing the function button. If repressing the function button, you can set the timer or health function.

After a function is selected by function button, if the unit hasn't been turned off and it hasn't received the signal from remote controller within 2 mins, the unit will circulate starting from the original setting function after repressing the function button. 2mins later or the unit is turned off or the unit has received the signal from remote controller, the unit will circulate from the first icon after repressing function button.

6. Fan Speed Button

After pressing speed button, it will be selected and displayed as:

```

auto → low → medium → high
      ↑           ↓
      └──────────┘
    
```

7. Display Method

1. Middle Number Part

(1) When there's malfunction protection (E1, E3, E4, E5, F2, F5), the unit only displays the error code and others won't be displayed. When there's multiple malfunctions, those malfunctions will be displayed circularly.

(2) In the normal running status, when setting temperature or timer is set, the unit will display the corresponding setting for 5s. After that, the unit will display the setting temperature and it will default to display H1 during the time of defrosting. When setting the setting temperature, timer and temperature display, they will be displayed in sequence as below: setting temperature, timer, temperature display and defrosting H1 and each status will be displayed for 5s. If one status (setting temperature, timer, temperature display, defrosting H1) isn't exist, that status will be omitted and the display will stop at the defaulted or setting temperature display. After the unit is energized, it defaults to display the ambient temperature.

The corresponding character and icon will be displayed simultaneously.

2. Fan Speed

When setting auto, low, medium and low fan speed, the corresponding character for the selected fan speed will be bright, and others won't be bright.

When setting auto, cooling, dry, fan and heating mode, the corresponding character for the selected mode will be bright and others won't be bright. The character and icon for the selected mode will be bright simultaneously. In auto mode, the auto and actual running mode will be displayed at the same time.

3. Ambient Mode

Ambient mode is including 5 kinds of mode: SAVE mode, room mode, office mode, restaurant mode and common mode. The selected ambient mode will be bright, others won't be bright.

- ① Up&down swing: when setting up&down swing, the icon and character will blink; when selecting the up&down swing, the icon and the character of (up&down) will be displayed. When there's no up&down swing or the swing the stopped, the icon and the character of "up&down" won't be displayed.
- ② Right&left swing: when setting right&left swing, the icon and character will blink; when selecting the right&left swing, the icon and the character of (right&left swing) will be displayed. When there's no right&left swing or the swing the stopped, the icon and the character of "right&left swing" won't be displayed.

- ③ Blow: when setting blow function, the icon and character will blink; when this function is selected, the icon and character will be displayed. If the blow function hasn't been selected, the icon and character won't be displayed. During the time of blow, only the icon and character are displayed, others won't be displayed.
- ④ E-HEATER: when setting E-HEATER function, the icon and character will blink; when this function is selected, the icon and character will be displayed. If the E-HEATER function hasn't been selected, the icon and character won't be displayed.
- ⑤ Timer: when setting timer function, the icon and character will blink; when this function is selected, the icon and character will be displayed. If the timer function hasn't been selected, the icon and character won't be displayed.
- ⑥ AIR: when setting AIR function, the icon and character will blink; when this function is selected, the icon and character will be displayed. If the AIR function hasn't been selected, the icon and character won't be displayed.
- ⑦ Sleep: when setting AIR function, the icon and character will blink; when this function is selected, the icon and character will be displayed. If the sleep function hasn't been selected, the icon and character won't be displayed.
- ⑧ Health: when setting AIR function, the icon and character will blink; when this function is selected, the icon and character will be displayed. If the health function hasn't been selected, the icon and character won't be displayed.
- ⑨ Turbo: when setting turbo function, the character will blink; when this function is selected, the character will be displayed. If the turbo function hasn't been selected, the character won't be displayed.
- ⑩ Setting: when setting function, the character of setting will blink; when this function is selected, the character will be displayed and the dual 8 will display the setting temperature. If the setting function hasn't been selected, the character and setting temperature won't be displayed.
- ⑪ Room temperature: when setting function, the character of room temperature will blink; when this function is selected, the character will be displayed and the dual 8 will display the indoor room temperature. If the room temperature function hasn't been selected, the character and indoor room temperature won't be displayed.

#### 5. Indicator Control

When the unit is at standby status after energizing, the power LED will be bright. After the unit is turned on, the running LED will be bright. When any one of the circumstances as below are occurred, the running LED will blink: defrosting, overcurrent protection, high pressure protection of compressor, low pressure protection of compressor, high temperature protection of discharge pipe, malfunction of indoor tube temperature sensor, malfunction of discharge temperature sensor.

#### 6. Light Control

LED display can be turned off by the light button on remote controller. When using remote controller to cancel "light", the complete LED displayer screen will go out, except the running LED. When turning off the light, if there's signal from button or remote controller, LED will go out after displaying for 5s.

## 7. Installation Manual

### 7.1 Important Notices

1. The unit installation work must be done by qualified personnel according to the local rules and this manual.
2. When removing the unit to the other place, please firstly contact with the local maintenance center.

#### Basic requirements for installation location

Installation at the following places may cause failure of the air conditioner. Please contact installation and service agency if the installation at such places cannot be avoided.

- Choose a place far away from heat source, steam and inflammable gases.
- A place with high frequency facilities, such as radio equipment, electric welder or medical equipment;
- A region with saline-sodic soil near the sea;
- A place full of machine oil;
- A place with sulphide gases (such as sulphur spring);
- An environment with special conditions.

#### Installation location of indoor unit

1. Select a place, avoid the inflammable gas produce or leakage.
2. Select a place avoid the water vapor or oil sprayed on the unit.
3. Ensure that airflow can reach every corner of the room.
4. Choose a place so that the connection pipe could be easily pulled out.
5. Select the place where the airflow of the unit can not be blocked.
6. Select the position where the few outer air influenced.
7. Select the firm and flat ground.
8. Ensure sufficient clearance and space for service and maintenance.
9. Ensure the installation of indoor unit is in conformity with the requirements of installation dimension drawing;
10. Do not use the unit in the immediate surroundings of a laundry a bath a shower or a swimming pool.
11. A location from which the condensation water can be drained out conveniently.

#### Installation location of outdoor unit

1. A place where noise and airflow generated by air exhaust do not affect the neighbors, animals and plants.
2. Ensure good ventilation of outdoor unit.
3. No obstacles near the outdoor unit obstructing the air intake and air exhaust of the unit.
4. The installation position shall be able to withstand the weight and vibration of the outdoor unit.
5. Choose a place far away the direct sunshine or strong wind.
6. The indoor unit shall be in conformity with the requirements of installation diagram, and ensure sufficient clearance and space for service and maintenance.
7. The height of connection pipe should be within 20 meters, and the length of it should be within 30 meters.
8. Please select the place keep out of the children's reach.
9. Select the place which do not influence the communal path way and the appearance of the city.

## Electric wiring

- 1.It should be connected with the special earth device on the building, it should be installed by the professional personnel. There should be enough capacity of creepage protector and air switch. (please refer to the following table)
- 2.The power supply must use the rated voltage and special circuit.
- 3.The diameter of the power wiring should be large enough. (Please refer to the following table)
- 4.The wiring work should conform to relative standard.
- 5.The ground must be connected.
- 6.Don't pull the power wire strongly.

## Requirements for electric safety

- 1.First install wire of outdoor unit and then wire of indoor unit. After finishing wiring and piping, connect the unit to the power supply.
- 2.Please strictly follow the instruction of this manual when installing indoor unit and its piping.
- 3.The unit is subject to change without prior notice.
- 4.Please read this manual carefully before installation.

The unit power is large, the power supply circuit supplied for the unit should accord with the following:

- a.Installed the air switch with suitable capacity, please refer to the following, the air switch must have the functions of magnetic tripping and heat tripping. (Note: never use the fuse to protect the branch circuit.)
- b.The capacity of wire diameter should be 1.5 times larger than the unit max. current
- c.Installed the creepage protector with enough capacity.
- d.Make sure to divide the branch circuit for the special circuit.
- e.The min. clearance between combustible surface and the air conditioner is 1.5 meters.

Models	Air switch capacity
GVA60AH-M3NNA5A	32A

### Note:

- Please pay attention to surrounding conditions (eg. Ambient temp., direct sun shine, rain drops etc.)
- The data of lead wire cross section listed above is the min. area. The cross section area of power cable, power connection wire should not be less than the data listed above.
- The power cable, power connection wire must adopt the standard copper-core cable accord with the national criterion.
- Earth wire must be connected to both of indoor and outdoor units.
- An all-pole disconnection switch having a contact separation of at least 3mm in all poles should be connected in fixed wiring.
- the appliance shall be installed in accordance with national wiring regulations.

## Notes for electric wiring:

1. Special circuit must be used for power supply.
2. The circuit must be installed by special serviceman.
3. Please do the wiring according to the following wiring diagram. The screws must be tightly fastened, the slippery screws must be changed, the tapping screw cannot be used for electric wiring.
4. Please wiring according to the circuit diagram on the unit.
5. Adopts the cables which are attached with the unit, please do not to change the cables optionally, and do not change the length and ends of the cable, if need to adjust, please contact with the local after-sales service center.
6. For the power cord which is without the plug, that cannot be connected the plug for using.
7. The electric wiring connection of indoor and outdoor should not be affected by the stretch and bending.
8.  is the symbol of earthing, it denotes that the yellow-green dual wire only can be connected with the place with the symbol.
9. After the electric installation completed, make sure to use wireclamp to fix the power cord, power supply connection cable and signal cable tightly, and ensure that there is enough space in the fix position and each connection terminals of the lead wires.
10. Please use about a half kilogram of force, to check whether each lead wire is installed well. When checking the air connector please enclasp it, and check each lead wire of which is connecting with the connector.

Installation diagram, please refer to the following.  
For the Signal path:

Fig.1

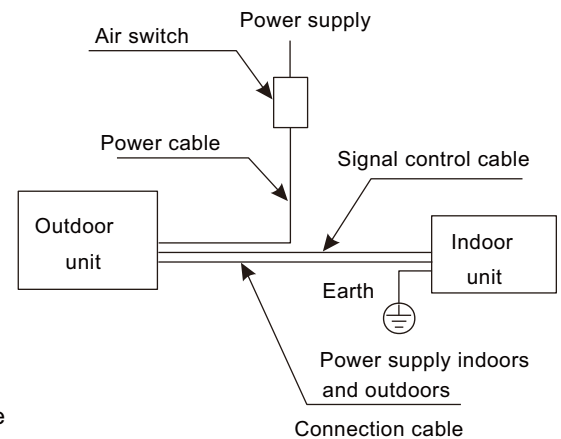

Note: the unit should be correctly earthed to avoid interference to the complete unit and ensure personal safety.

## Requirements for earthing

1. The air conditioner is the first class electric appliance:
2. The yellow and green dual color wire in the air conditioner is earth wire, it cannot be used for other purposes, do not cut off it. Do not fix it by the tapping screw: otherwise, it can cause the electric shock.
3. Please do not connect the earth wire to the place: The power supply must be reliably earthed.

(1) Water pipe    (2) Gas pipe    (3) Drainage pipe    (4) The place where is unreliable by the professional

## Other

1. All electric installation must be done by professional personnel according to local law, regulation and this manual.
2. The connection method between air conditioner and power cable as well as the interconnection of each separate components, please refer to the circuit diagram on the unit.
3. The model and rated value of blown fuse please refer to the corresponding silk-screen on the controller or fuse sleeve.
4. The outer static pressure is 0MPa when the unit is testing.



## 7.2 Installation Dimension Diagram

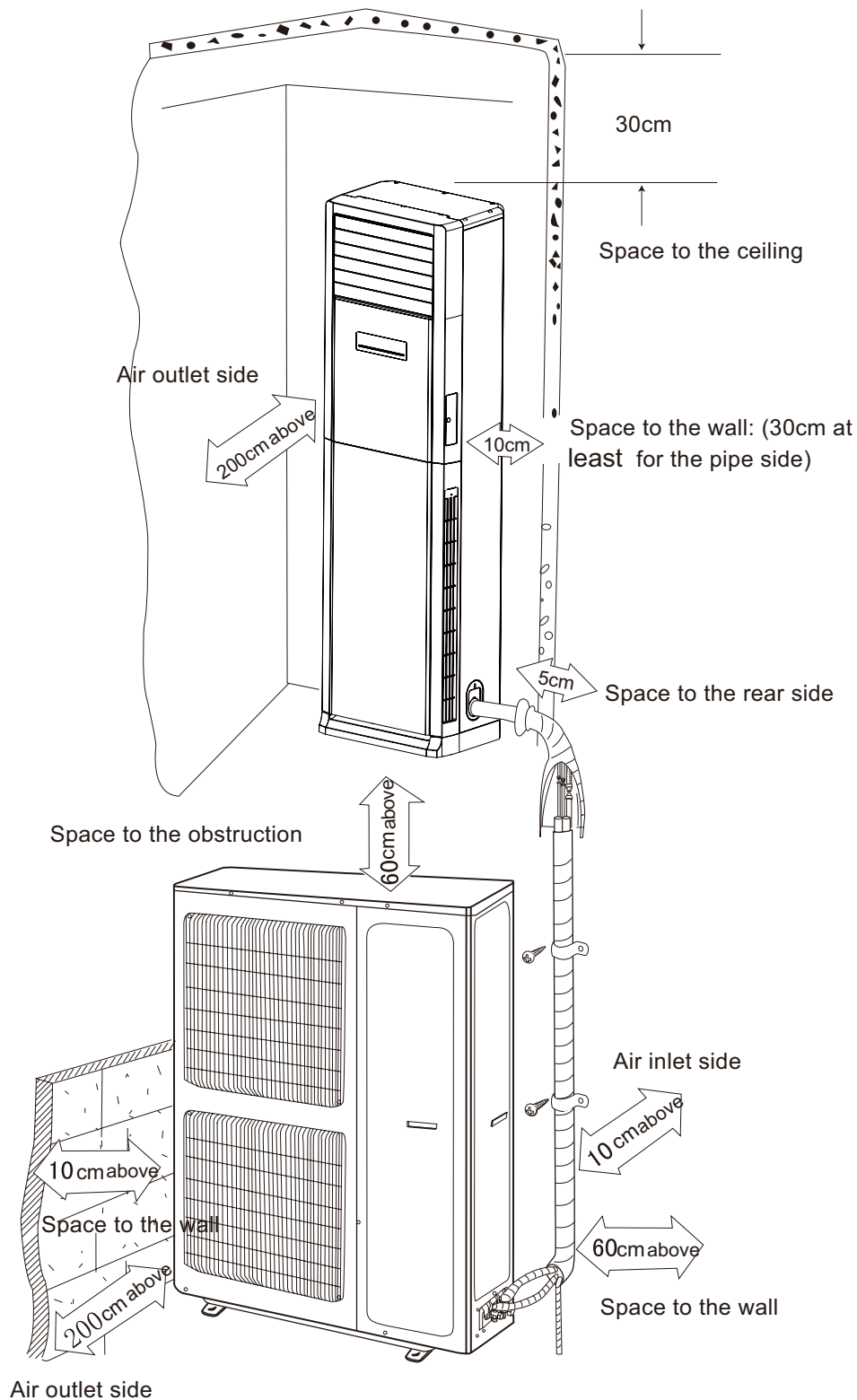

This is just the schematic plan. Please refer to the actual product.

## 7.3 Installation of Indoor Unit

### Installation of connection pipe

Before wiring and piping, please remove the filter after opening the glass panel.

1.As shown in Fig.2,take out the decorative strip at position 1 and then unscrew the screws.Remove the screws fixing the filter after opening the glass panel.At last take out the filter along the arrow direction at position 3.

2.During piping and wiring in the left and at the rear side,the attached accessories should be used,as shown in Fig.4 .

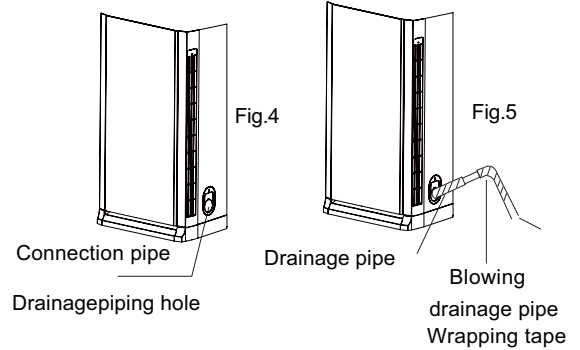
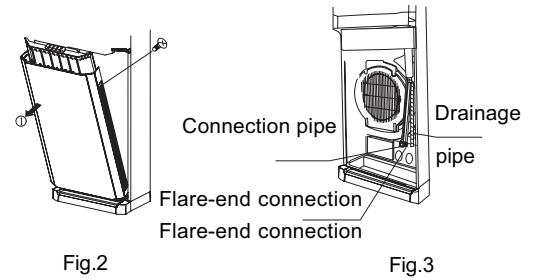

### Installation of drainage pipe

1. Make sure drainage pipe is led outdoors (discharge side).
2. Butt-joint drainage pipe in the unit with blowing drainage pipe and fix them with insulated tape.
3. If the drainage pipe should be wrapped with heat-preservation material (at least 9 mm thickness), and then wrap it with tape to prevent air from entering into the pipe,which will cause condensation.
4. After connecting, check if water can discharge properly or if there is any leakage. (As shown in Fig.5)

### Electric connection

- 1.Disassemble the air intake grill.
- 2.Remove screws from the cover of electric box to expose the box.
- 3.Put the power connection wire through the single wire hole of the indoor unit rear side, the pull it out from the front.
4. According to the diagram for wiring,according to the marks on wire board for connection correspondingly,as shown in Fig.6.

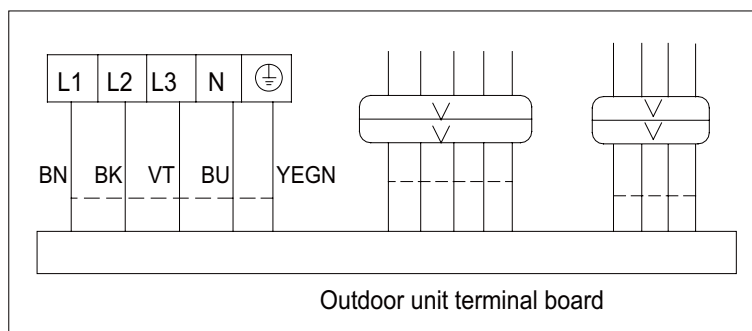

Fig.6.

5. Place the section with sleeve of the power connection wire into the wire groove, then cover the electric box cover, tighten the fixing screw, and tighten the connection wire.
6. Recover the electric box cover.
7. For the cooling and heating unit, the signal control wire is connected via connector and indoor unit, and clasp the signal control wire with the wire clamp, which is under the bottom of body case.

### Note:

When the connection wire length isn't enough, please contact with the appointed service shop for buying a dedicated electric wire with enough length, the connection isn't allowed between the wire.

- The wrong wiring connection isn't allowed, it may cause the malfunction of the components.
- Tighten the terminal screw.
- After tightened the screw, and slightly pull the electric wire to confirm whether it is firm or not.
- Wrong earth wire connection may cause electric shock.
- The electric wire covering plate must be fixed well, and tighten the connection wire, if the wire covering plate isn't installed well, that may lead the dust, moisture enter in or due to the outside force impact, it may cause fire or electric shock.

### Installation of baffle

Please install it after installation of connection pipe and drainage pipe according to Fig.7.

1. Loosen the screws and adjust the baffle position up and down to clamp connection pipe/drainage pipe as much as possible.
2. Tighten the screws.

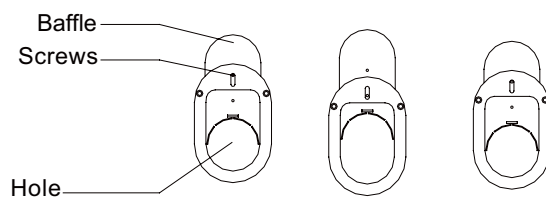

Fig.7

## Notes for piping

Pipes for refrigerant and drainage pipes should be insulated to avoid frosting and dripping.

1. Both of the indoor and outdoor units adopt flare-end connection. Refrigerant pipe as shown below is used to connect indoor and outdoor units. (As shown in Fig.8)

Note: Don't bend the bendable pipe back and forth more than 3 times. Insulate all exposed parts of the flare-end connection joint and refrigerant pipe. (As shown in Fig.9)

2. Check valve of the outdoor unit should be closed (in factory). Every time of connection, screw cap at check valve should be unscrewed and then connect it with flare-end pipe immediately (within 5 min). Otherwise, dust, moisture and other impurities may go into the pipe and cause malfunction.

Notes for bendable pipe:

1. The part with bendable pipe should be used in indoor side.
2. The bending angle should not be more than 90°.
3. It's better for the bend to be in the middle of the pipe and the radius of the bend is the bigger the better.
4. Don't bend the bendable pipe more than three times.

When bending the pipe

1. Cut some part of the insulation pipe at the place of the bend (and wrap with polythene tape after bending).
2. Make radius of the bend as big as possible so that the pipe will not get flat or broken.
3. Tighten the pipe bending by the rubber bender.

When using copper pipe bought locally

Check valve of the outdoor unit should be closed completely (in the factory). After connection of indoor and outdoor units via connection pipe, discharge the air from service vent of low-pressure check valve of the outdoor unit. After that, screw down the nuts to service vent.

Install the big handle.

After step 1 or 2 above, check valve of the outdoor unit should be fully opened to ensure smooth flow of connection pipe between indoor and outdoor units.

Note: Before fastening nut of the flare-end pipe, please apply some refrigerant oil to the end of the pipe and the joint.

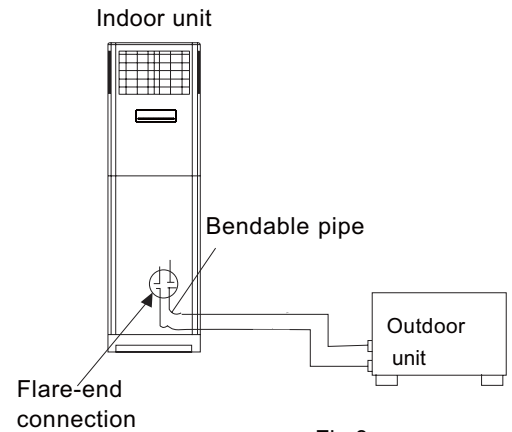

Fig.8

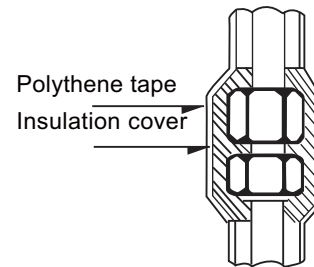

Fig.9

Bend the pipe with thumbs

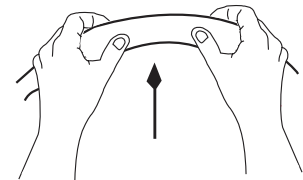

Fig.10

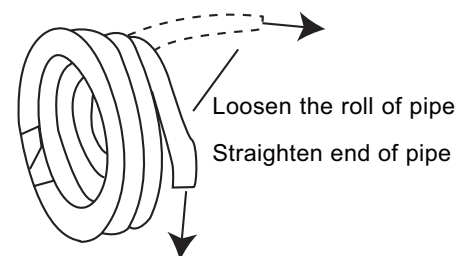

Fig.11

## Installation of connection pipe

1. Align the center of the piping flare with the pyramidal face of relevant valve.
2. Screw in the flare nut by hand and then tighten the nut with spanner and torque wrench refer to the following.

Hex nut	Tightening torque (N.m)
Φ12	50~55
Φ19	70~75

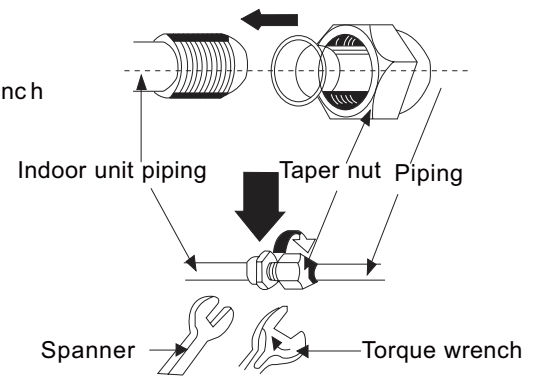

Fig.12

NOTE: Firstly connect the connection pipe to indoor unit, then to outdoor unit; pay attention to the piping bending, and do not damage the connection pipe; the joint nut couldn't tighten too much, otherwise it may cause leakage.

## 7.4 Installation of Outdoor Unit

### When using vacuum pump

1. Connect charging hose of to charge nozzle. (both cores of gas and liquid valves should be shut down tightly.)
2. Connect joint of charging hose to vacuum pump.
3. Fully open low-pressure valve(Lo) of manometer.
4. Make vacuum pump operate for 15 min above. Close low pressure valve(Lo) to stop vacuum pump after confirmation of  $-1.0 \times 10^5 \text{pa}$  ( $-76 \text{cmHg}$ ) at manometer. Then check if there is air in the pipe (keep for 2 min to see if indicated needle of manometer returns). If there is, re-operate the vacuum pump after restoration.
5. Remove charging hose from gas valve.
6. Fully open the cores of gas valve and liquid valve.
7. Tighten bonnet of gas valve and liquid valve and nut of charge nozzle. (As shown in Fig.15)

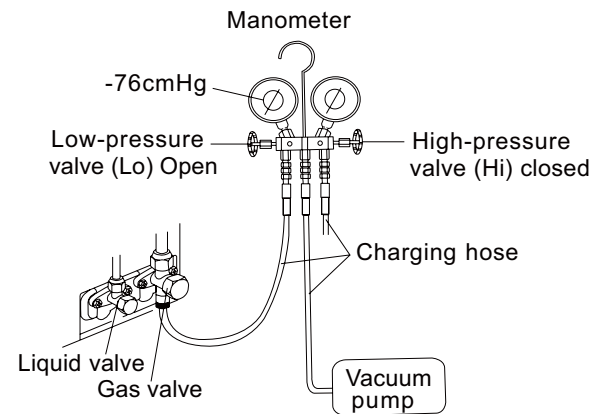

Fig.15

### Leakage detection

Coat soap water at the gap between connection pipes to see if there is any leakage. If there is air bubble at this position, it should leak. (As shown in Fig.16) Leakage detector, if possible, can be used.

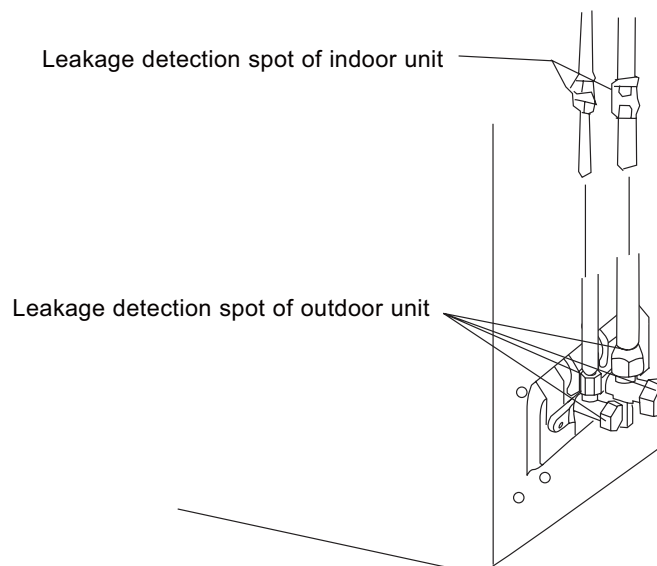

Fig.16

### Wiring method

1. Remove the front side plate.
2. Put it through to the outdoor wire hole.
3. Please refer to the electric wiring connection of the indoor unit, then fix them with wire clamp.(As shown in Fig.17)

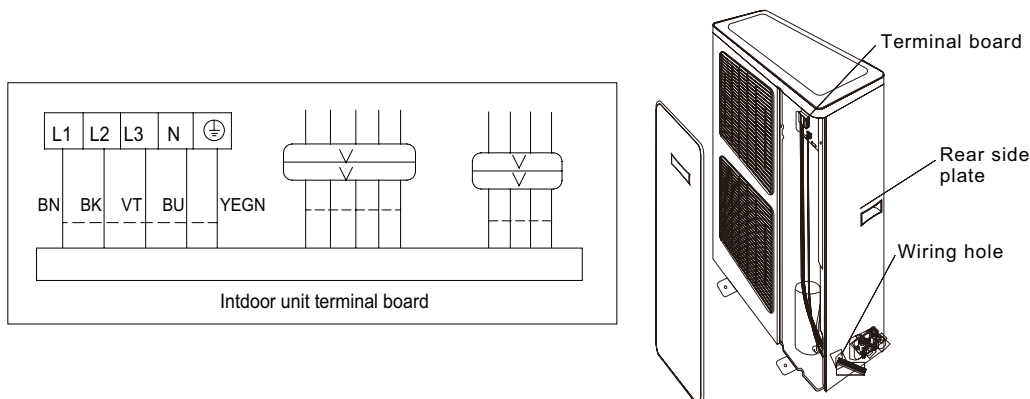

Fig.17

## 7.5 Test Operation and Check after Installation

### Check after installation

Items to be checked	Possible malfunction
Has it been fixed firmly?	The unit may drop, shake or emit noise.
Have you done the refrigerant leakage test?	It may cause insufficient cooling(heating)capacity.
Is heat insulation sufficient?	It may cause condensation and dripping.
Is water drainage well?	It may cause condensation and dripping.
Is the voltage in accordance with the rated voltage marked on the nameplate?	It may cause electric malfunction or damage the part.
Is the electric wiring and piping connection installed correctly and securely?	It may cause electric malfunction or damaged the part.
Has the unit been connected to a secure earth connection?	It may cause electrical leakage.
Is the power cord specified?	It may cause electric malfunction or damage the part.
Is the inlet and outlet been covered?	It may cause insufficient cooling(heating)capacity.
Has the length of connection pipes and refrigerant capacity been recorded?	The refrigerant capacity is not accurate.

### Test operation

1. Before test operation
  - (1) Do not switch on power before installation is finished completely.
  - (2) Electric wiring must be connected correctly and securely.
  - (3) Cut-off valves of the connection pipes should be opened.
  - (4) All the impurities such as scraps and thums must be cleared from the unit.
2. Test operation method

## 8.Exploded Views and Parts List

### 8.1 Indoor Unit

Model: GVA60AH-M3NNA5A/I

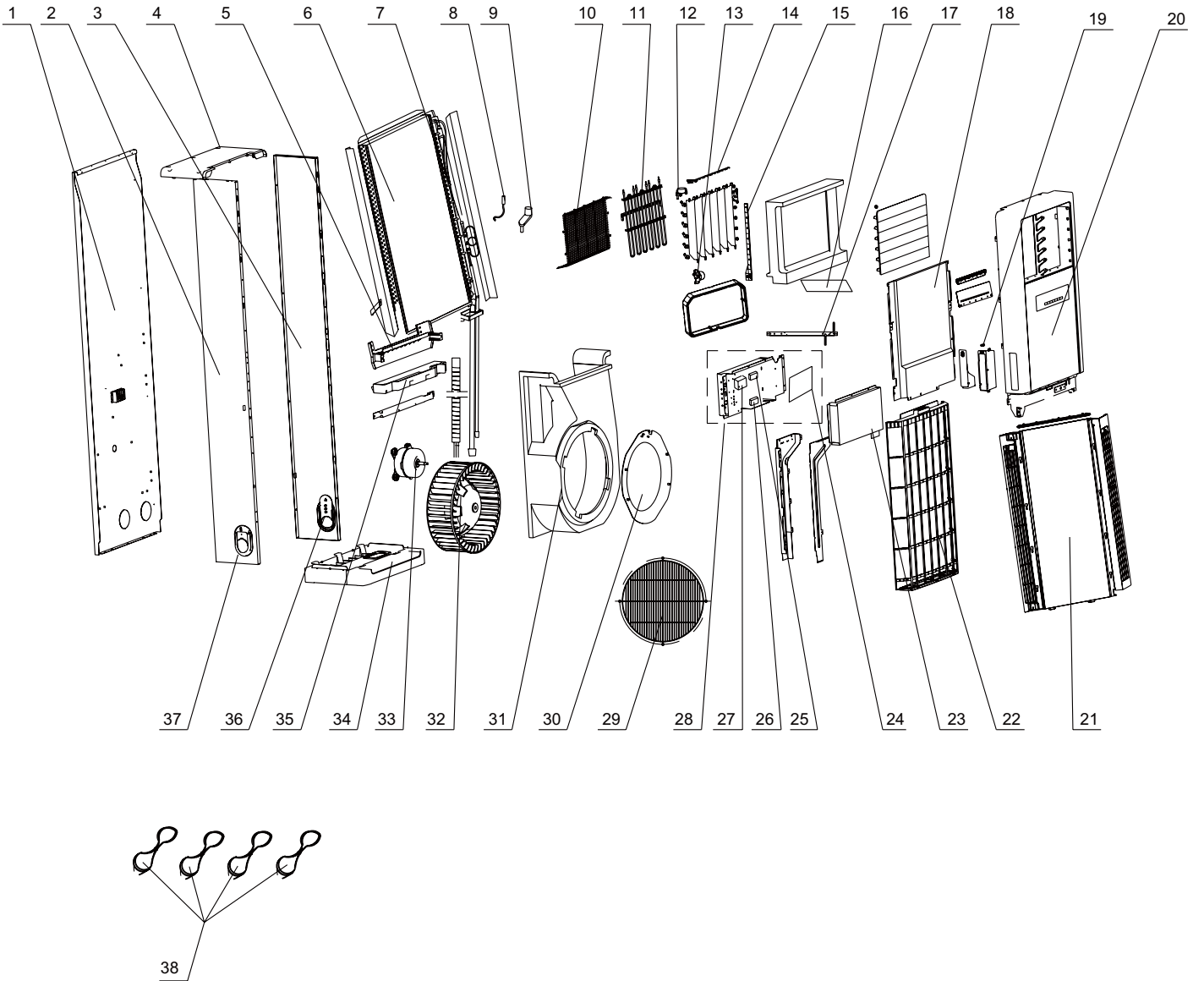



No.	Description	Part Code	Qty
		GVA60AH-M3NNA5A/I	
		Product Code	
		CG090N00200	
1	Rear Plate Assy	01304290	1
2	Left Side Plate Sub-Assy	0130430401	1
3	Right Side Plate Sub-Assy	0130430301	1
4	Top Cover Sub-Assy	22244152	1
5	Breakwater Sub-Assy	01364503P	1
6	Evaporator Assy	01004489	1
7	Capillary Sub-assy	03004237	1
8	Ambient Temperature Sensor	39000190	1
9	Crank 1	10564204	1
10	Rear Grill	01474034	1
11	Electric Heater	32004079	1
12	Step Motor	1521421102	1
13	Step Motor	1521400801	1
14	Swing Lever	10584218	1
15	Guide Blade Lever	10584089	1
16	Display Board	30563195	1
17	Propeller Housing Press Plate Sub-assy	01384063	1
18	Air Guard Assy	01364174	1
19	Latch	70810302	1
20	Air Outlet Panel Assy	2000453403	1
21	Air Intake Panel Assy	20004536	1
22	Filter Sub-Assy	11124100	1
23	Electric Box Cover Sub-Assy	01404388	1
24	Main Board	30134135	1
25	Capacitor CBB61	33010056	1
26	Terminal Board	42010258	1
27	Transformer	43110287	1
28	Electric Box Assy	01404919	1
29	Protective Covering	01474027	1
30	Diversion Circle	10374435	1
31	Propeller Housing Sub-assy	12104058	1
32	Centrifugal Fan	10314401	1
33	Fan Motor	1501442409	1
34	Chassis	22224020	1
35	Water Tray Sub-Assy	12314811	1
36	Baffle Plate	2611408801	3
37	Rear Cover	2224422101	3
38	Connecting Cable	400205396	0
	Connecting Cable	400205397	0
	Connecting Cable	4003213429	0
	Connecting Cable	4003213430	0

The data above are subject to change without notice.

## 8.2 Outdoor Unit

Model: GVA60AH-M3NNA5A/O

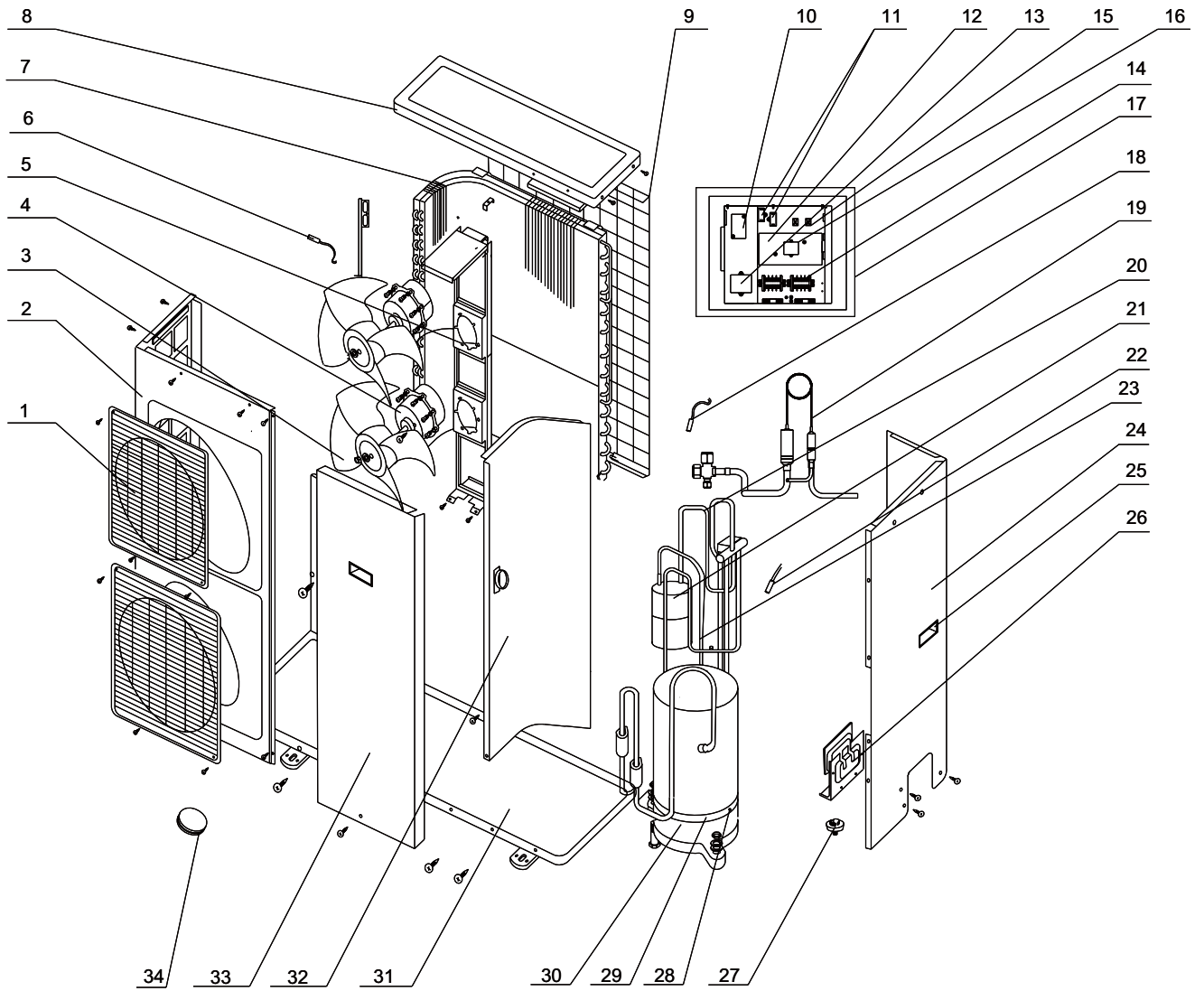

No.	Description	Part Code	Qty
		GVA60AH-M3NNA5A/O	
		Product Code	
1	Front grill	22414102	2
2	Cabinet	01435436	1
3	Axial Flow Fan	10335253	2
4	Fan Motor	15015451	2
5	Motor Support Sub-Assy	01705471	1
6	Ambient Temperature Sensor	39000199	1
7	Condenser Assy	01105397	1
8	Top Cover	01255472	1
9	Rear Grill	01475432	1
10	AC Contactor	44010226	1
11	Capacitor CBB61	33010013	2
12	Over Current Protector	46020103	1
13	Phase Reverse Protector	46020052	1
14	Terminal Board	42010258	2
15	Terminal Board	42011103	2
16	Transformer	43110242	1
17	Electric Box Assy	014054709	1
18	Outdoor Tube Sensor	390001941	1
19	Capillary Sub-assy	03005564	1
20	4-Way Valve Assy	03025268	1
21	Gas-liquid Separator Assy	07225016	1
22	Air-out Temp Sensor	39000163	1
23	Inhalation Tube Sub-Assy	03639066	1
24	Rear Side Plate Sub-Assy	01303712	1
25	Handle	26235253	2
26	Valve Support Sub-Assy	01715001	1
27	Drainage Connector	06123401	1
28	Terminal Board	42010157	2
29	Electric Heater(Compressor)	76515404	1
30	Compressor and fittings	00129052	1
31	Chassis Sub-assy	0120514301P	1
32	Mid Clapboard Sub-assy	01235473	1
33	Front Side Plate	01305431	1
34	Drainage Plug	06813401	2

The data above are subject to change without notice.

## 9. Troubleshooting

### 9.1 Precautions before Performing Inspection or Repair

Be cautious during installation and maintenance. Do operation following the regulations to avoid electric shock and casualty or even death due to drop from high attitude.

\* Static maintenance is the maintenance during de-energization of the air conditioner.

For static maintenance, make sure that the unit is de-energized and the plug is disconnected.

\* dynamic maintenance is the maintenance during energization of the unit.

Before dynamic maintenance, check the electricity and ensure that there is ground wire on the site. Check if there is electric ity on the housing and connection copper pipe of the air conditioner with voltage tester . After ensure insulation place and the safety , the maintenance can be performed.

Take sufficient care to avoid directly touching any of the circuit parts without first turning of f the power.

At times such as when the circuit board is to be replaced, place the circuit board assembly in a vertical position.

Normally,diagnose troubles according to the trouble diagnosis procedure as described below.(Refer to the check points in servicing written on the wiring diagrams attached to the indoor/outdoor units.)

NO.	Troubleshooting procedure
1	Confirmation
2	Judgement by Flashing LED of Indoor/Outdoor Unit
3	How to Check simply the main part

Precautions when inspecting the control section of the outdoor unit :

A large-capacity electrolytic capacitor is used in the outdoor unit controller (inverter).Therefore,if the power supply is turned off,charge(charging voltage DC380V)remains and discharging takes a lot of time..

After turning off the power source,if touching the charging section before discharging, an electrical shock may be caused.

Please open the outdoor unit after the unit is power off for 20min.

### 9.2 Confirmation

(1)Confirmation of Power Supply

Confirm that the power breaker operates(ON) normally;

(2)Confirmation of Power Voltage

Confirm that power voltage is AC 380-415±10%.

If power voltage is not in this range, the unit may not operate normally .

### 9.3 Judgement by Flashing LED of Indoor/Outdoor Unit

No.	Malfunction Name	Display Method of Indoor Unit			A/C Status	Possible Causes	
		Error Code	Indicator lamp (During blinking, ON for 0.5S and OFF for 0.5 S)				
			Operation Lamp	COOL Lamp			HEAT Lamp
1	High pressure protection	E1	OFF 3S and blinks once (inverter unit); the running indicator blinks (non-inverter floor standing unit); As for other types of units, please refer to the detailed function requirement.			<p>During cooling and drying operation, except indoor fan operates, all loads stop operation. During heating operation, if it is inverter unit, the complete unit stops; if it is floor standing unit, the complete unit stops and operation of remote controller or controller is unavailable.</p> <ol style="list-style-type: none"> <li>1. The main board and the display panel are not connected well.</li> <li>2. The OVC terminal on main board is not connected well with the high pressure switch on the complete unit.</li> <li>3. The wiring of high pressure switch is loosened.</li> <li>4. Refrigerant is superabundant;</li> <li>5. Poor heat exchange (including blocked heat exchanger and bad radiating environment );</li> <li>6. Ambient temperature is too high; (if it is 3-phase unit, the high pressure protection may be caused by overcurrent protection due to this reason)</li> <li>7. The supply voltage is abnormal (if it is 3-phase unit, the high pressure protection may be caused by overcurrent protection due to this reason)</li> <li>8. The air intake and air discharge at indoor / outdoor heat exchanger are not smooth. The air cycle is short circuited.</li> <li>9. Filter and heat exchange fins of indoor/outdoor units are blocked.</li> <li>10. The system pipeline is blocked.</li> <li>11. The gas valve and liquid valve for outdoor unit are not completely opened.</li> <li>12. The OVC input is at high level.</li> </ol>	
2	Freeze protection	E2	OFF 3S and blinks twice (inverter unit); running indicator blinks (non-inverter floor standing unit); As for other types of units, please refer to the detailed function requirement.			<p>During cooling and drying operation, compressor and outdoor fan stop while indoor fan operates.</p> <ol style="list-style-type: none"> <li>1. Poor air-return in indoor unit;</li> <li>2. Abnormal fan speed;</li> <li>3. Dirty evaporator;</li> <li>4. System is normal, but the indoor tube temperature sensor is abnormal, or the tube temperature sensor is not connected well.</li> </ol>	

3	Low pressure protection of compressor	E3	OFF 3S and blinks 3 times (inverter unit); running indicator blinks (non-inverter floor standing unit); As for other types of units, please refer to the detailed function requirement.			The complete unit stops	<ol style="list-style-type: none"> <li>1. The main board and display panel are not connected well.</li> <li>2. The LPP terminal on the main board is not connected well with the high pressure switch on the complete unit.</li> <li>3. The wiring of the high pressure switch is loosened. High pressure switch is damaged or poorly contacted.</li> <li>4. Insufficient or leaking out refrigerant.</li> <li>5. The LPP input is at high level.</li> </ol>
4	High discharge temperature protection of compressor	E4	OFF 3S and blinks 4 times (inverter unit); running indicator blinks (non-inverter floor standing unit); As for other types of units, please refer to the detailed function requirement.			During cooling and drying operation, compressor and outdoor fan stop while indoor fan operates. During heating operation, all loads stop.	<ol style="list-style-type: none"> <li>1. Abnormal system (e.g.: blockage, etc)</li> <li>2. Abnormal rotation speed of outdoor motor (cooling)</li> <li>3. Abnormal air intake (cooling)</li> <li>4. System is normal, but the compressor discharge temperature sensor is abnormal or poorly contacted.</li> </ol>
5	Overcurrent protection	E5	OFF 3S and blinks 5 times (inverter unit); running indicator blinks (non-inverter floor standing unit); As for other types of units, please refer to the detailed function requirement.			During cooling and drying operation, compressor and outdoor fan stop while indoor fan operates. During heating operation, all loads stop.	<ol style="list-style-type: none"> <li>1. Unstable supply voltage. Normal fluctuation shall be within 10% of the rated voltage on the nameplate.</li> <li>2. Supply voltage is too low and load is too high.</li> <li>3. Measure the current of live wire on main board. If the current isn't higher than the overcurrent protection value, please check the controller.</li> <li>4. The indoor and outdoor heat exchangers are too dirty, or the air inlet and air outlet are blocked.</li> <li>5. The fan motor is not running. Abnormal fan speed: fan speed is too low or the fan doesn't run</li> <li>6. The compressor is not running normally. There is abnormal sound, oil leakage or the temperature of the shell is too high, etc.</li> <li>7. There's blockage in the system (filth blockage, ice plug, greasy blockage, Y-valve hasn't been opened completely)</li> </ol>

## 9.4 How to Check Simply the Main Part

### (1) High pressure protection (E1)

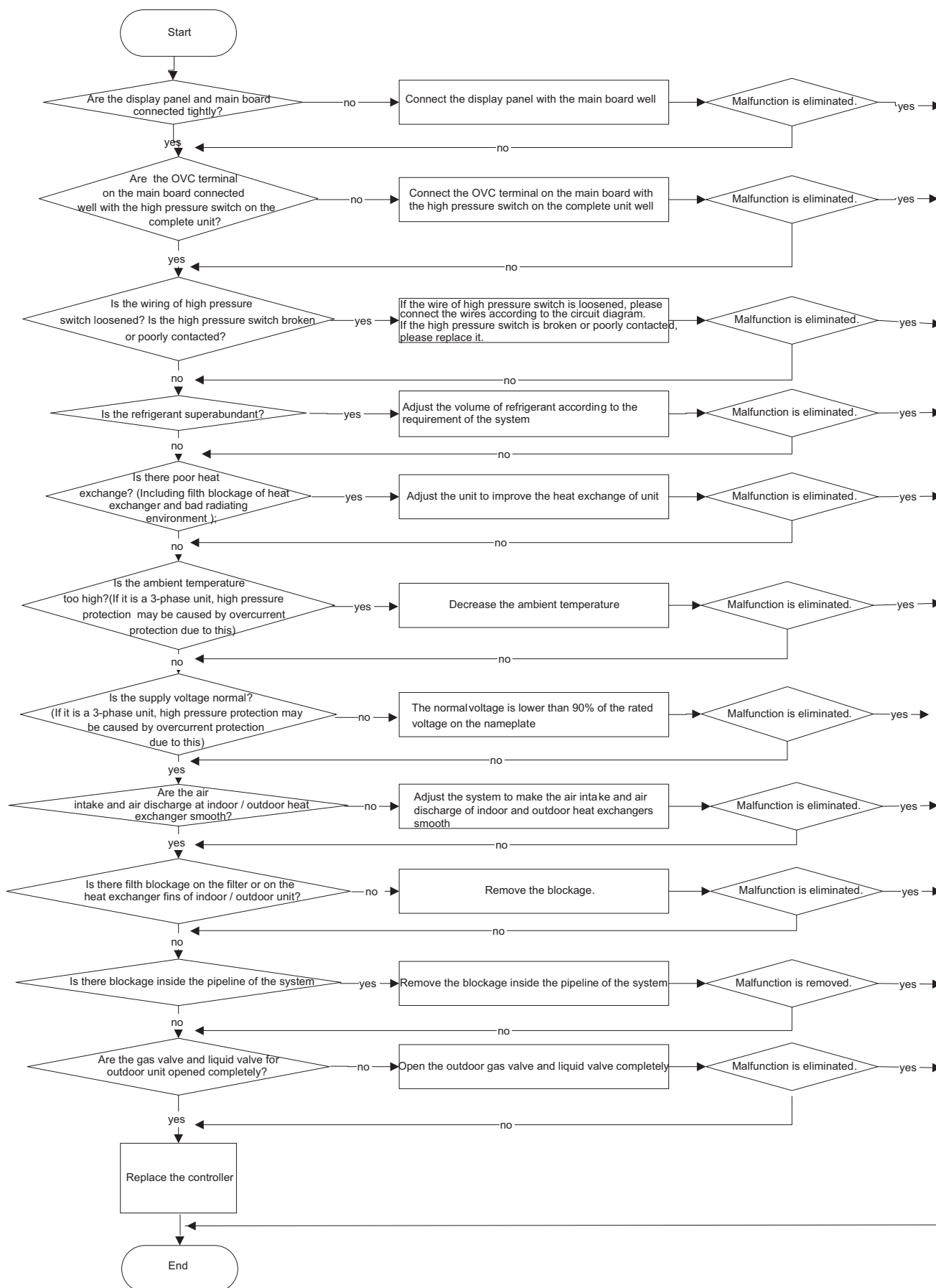

(2) Freeze protection(E2)

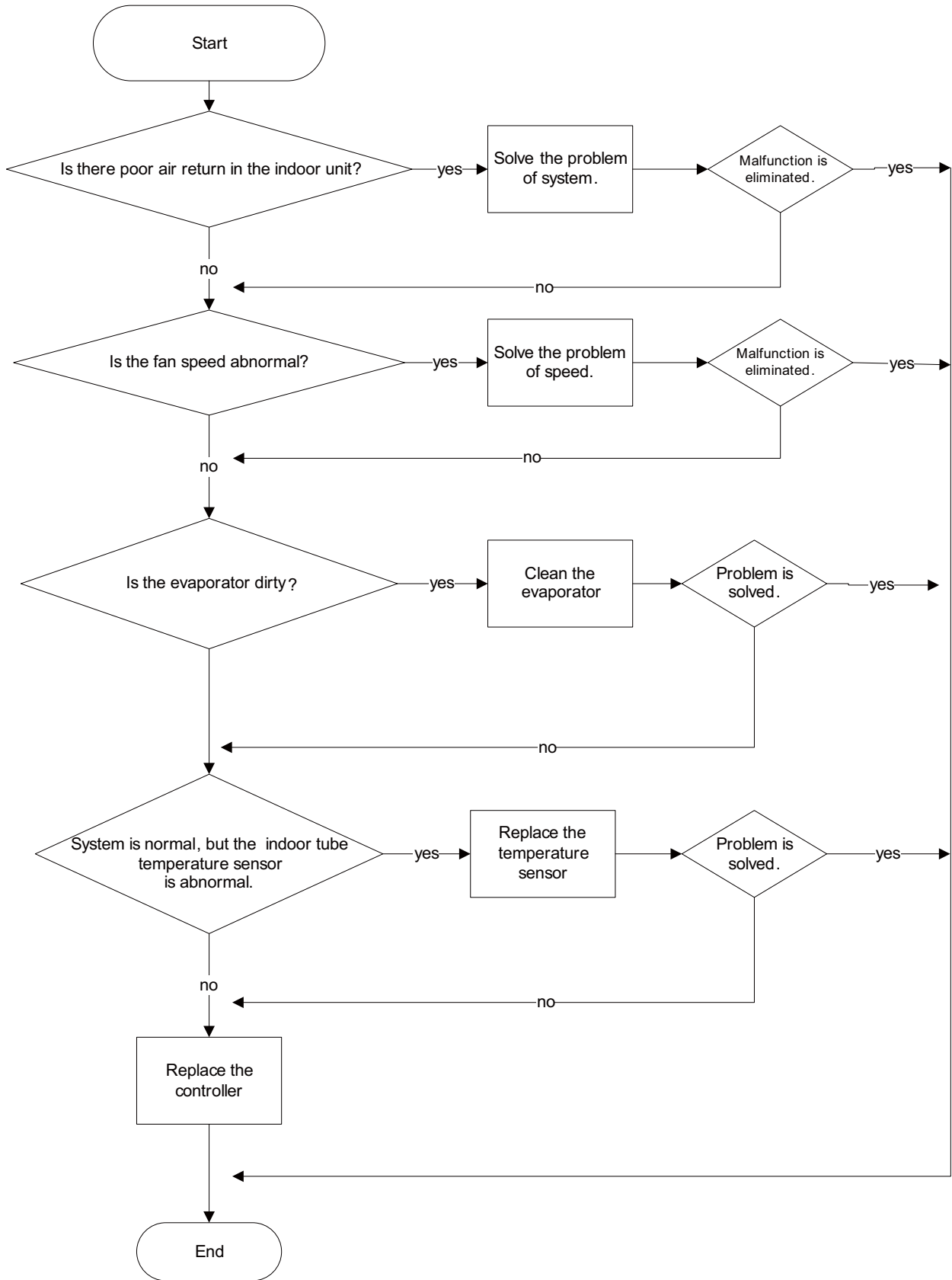



(3) Low pressure protection of compressor (E3)

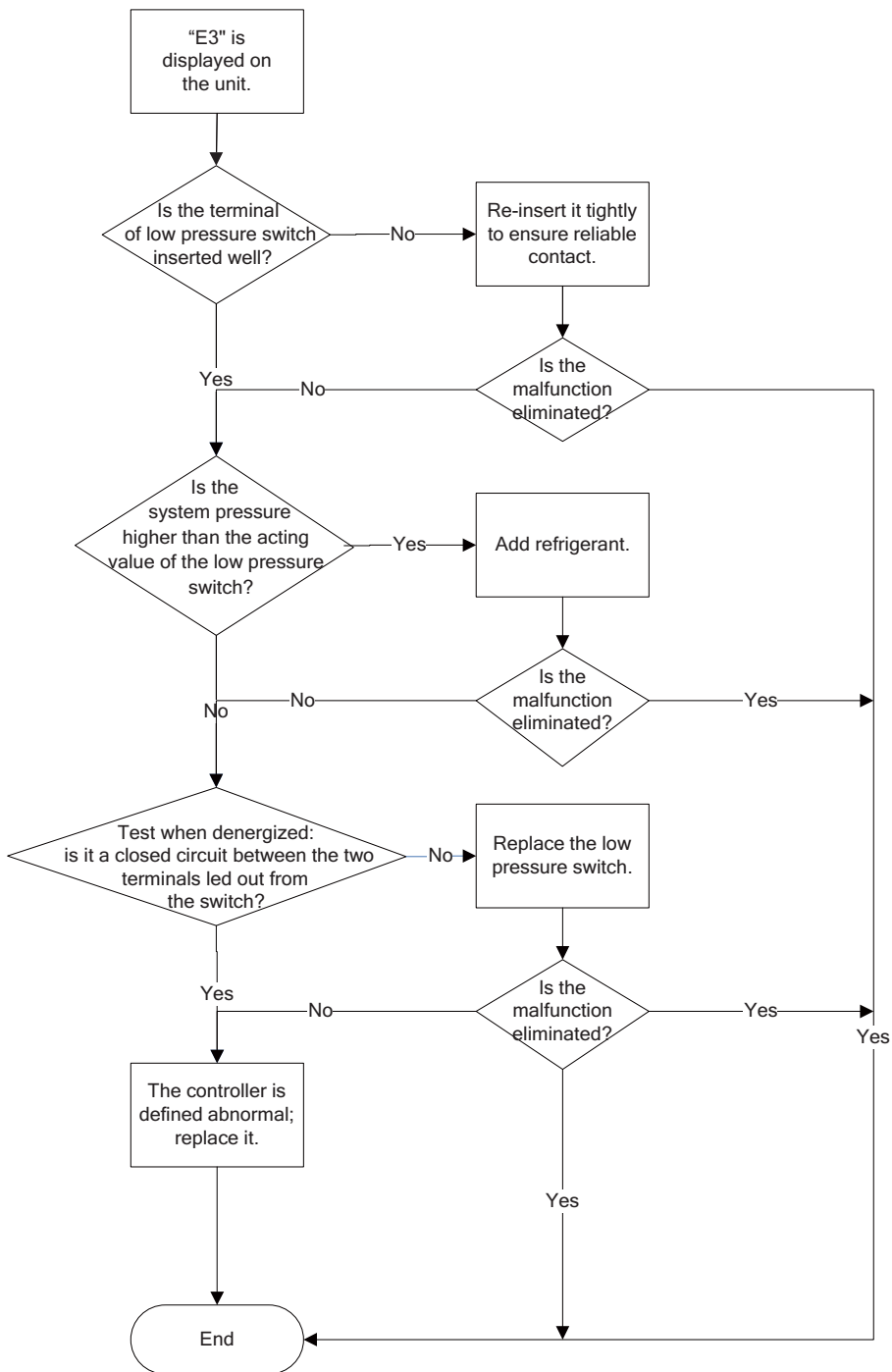

(4) High discharge temperature protection of compressor (E4)

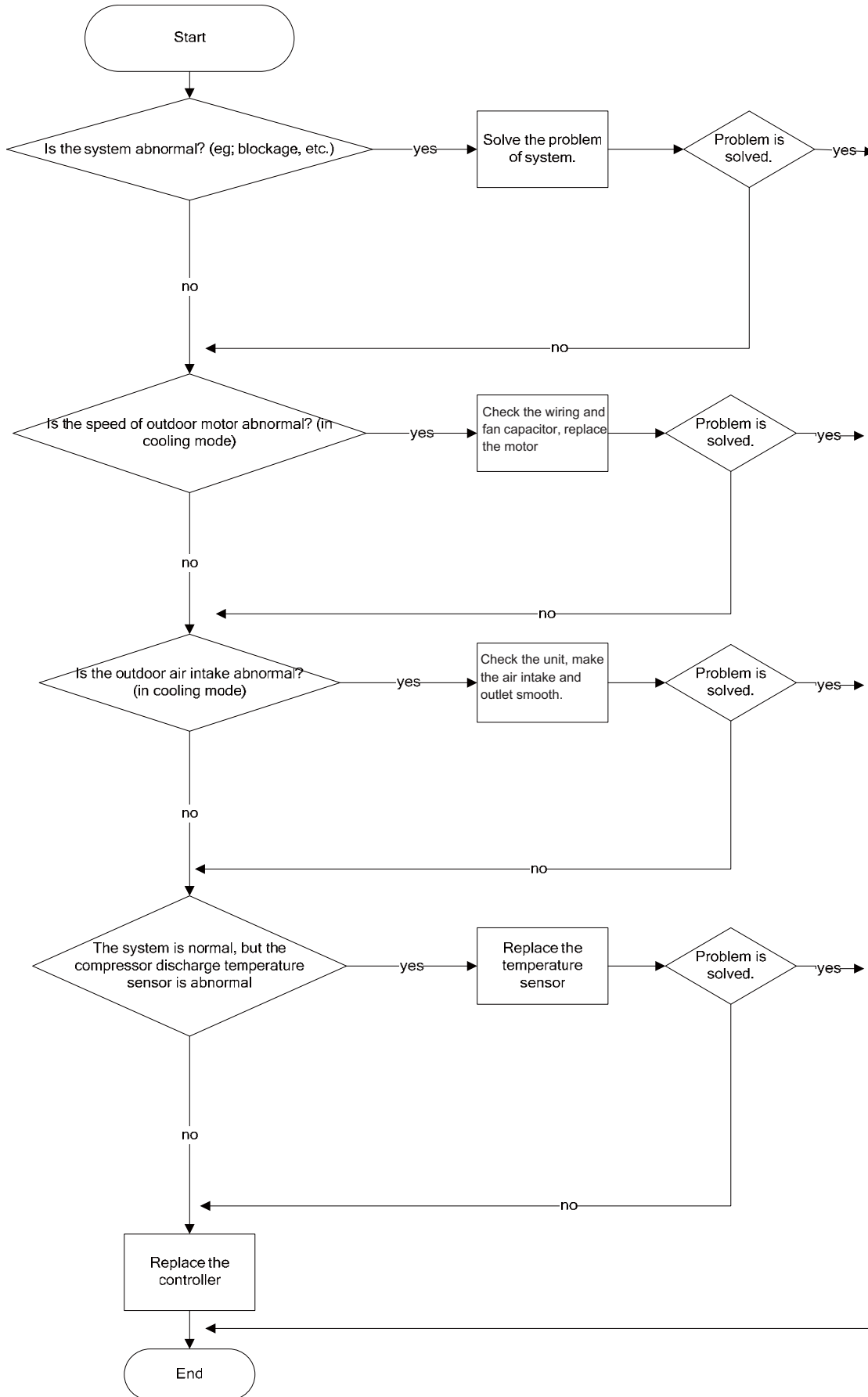

(5) Overcurrent protection (E5)

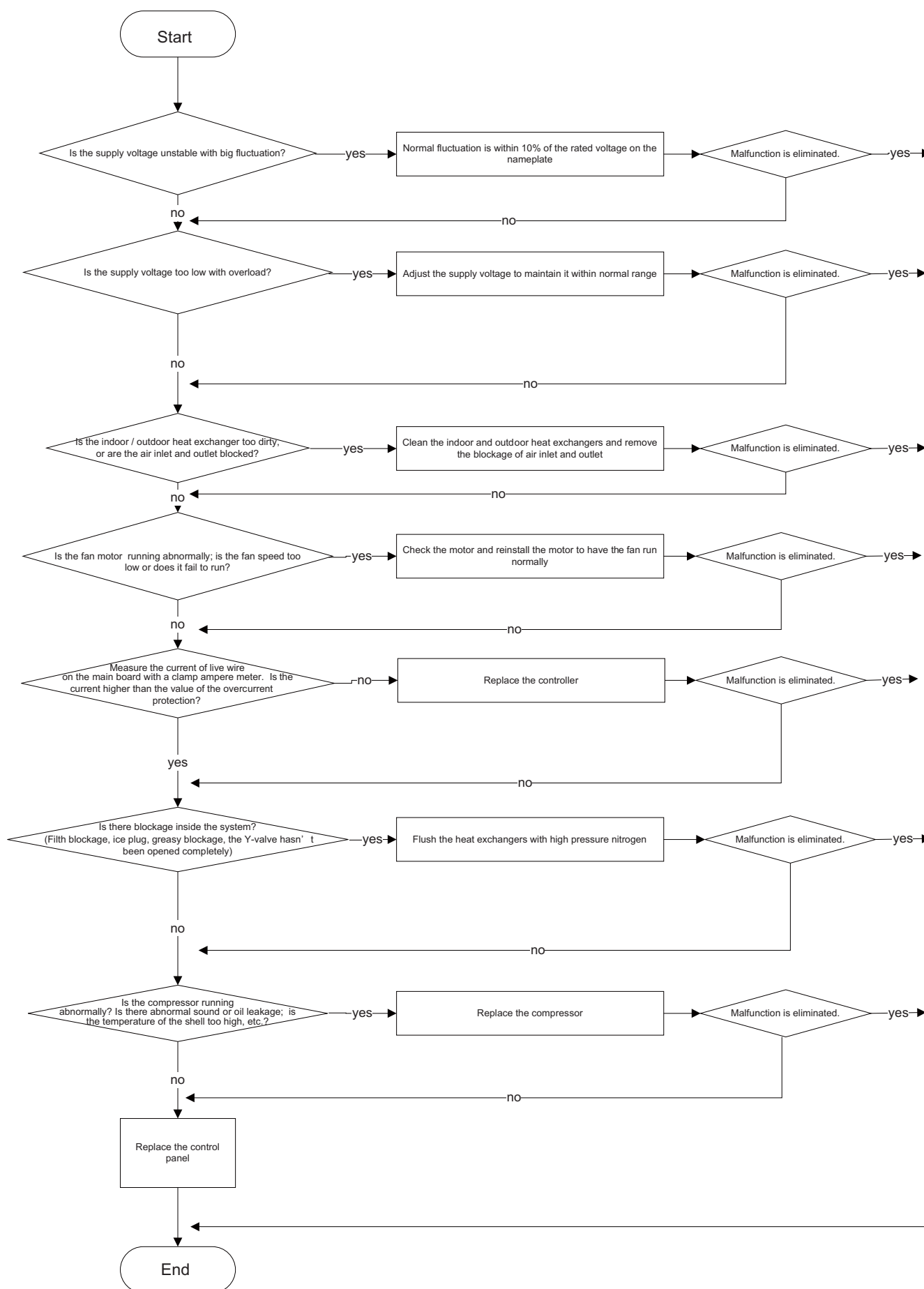

**Appendix 1: Resistance Table of Ambient Temperature Sensor for Indoor and Outdoor Units(15K)**

Temp. (°C)	Resistance (kΩ)	Temp. (°C)	Resistance (kΩ)	Temp. (°C)	Resistance (kΩ)	Temp. (°C)	Resistance(kΩ)
-19	138.1	20	18.75	59	3.848	98	1.071
-18	128.6	21	17.93	60	3.711	99	1.039
-17	121.6	22	17.14	61	3.579	100	1.009
-16	115	23	16.39	62	3.454	101	0.98
-15	108.7	24	15.68	63	3.333	102	0.952
-14	102.9	25	15	64	3.217	103	0.925
-13	97.4	26	14.36	65	3.105	104	0.898
-12	92.22	27	13.74	66	2.998	105	0.873
-11	87.35	28	13.16	67	2.896	106	0.848
-10	82.75	29	12.6	68	2.797	107	0.825
-9	78.43	30	12.07	69	2.702	108	0.802
-8	74.35	31	11.57	70	2.611	109	0.779
-7	70.5	32	11.09	71	2.523	110	0.758
-6	66.88	33	10.63	72	2.439	111	0.737
-5	63.46	34	10.2	73	2.358	112	0.717
-4	60.23	35	9.779	74	2.28	113	0.697
-3	57.18	36	9.382	75	2.206	114	0.678
-2	54.31	37	9.003	76	2.133	115	0.66
-1	51.59	38	8.642	77	2.064	116	0.642
0	49.02	39	8.297	78	1.997	117	0.625
1	46.6	40	7.967	79	1.933	118	0.608
2	44.31	41	7.653	80	1.871	119	0.592
3	42.14	42	7.352	81	1.811	120	0.577
4	40.09	43	7.065	82	1.754	121	0.561
5	38.15	44	6.791	83	1.699	122	0.547
6	36.32	45	6.529	84	1.645	123	0.532
7	34.58	46	6.278	85	1.594	124	0.519
8	32.94	47	6.038	86	1.544	125	0.505
9	31.38	48	5.809	87	1.497	126	0.492
10	29.9	49	5.589	88	1.451	127	0.48
11	28.51	50	5.379	89	1.408	128	0.467
12	27.18	51	5.197	90	1.363	129	0.456
13	25.92	52	4.986	91	1.322	130	0.444
14	24.73	53	4.802	92	1.282	131	0.433
15	23.6	54	4.625	93	1.244	132	0.422
16	22.53	55	4.456	94	1.207	133	0.412
17	21.51	56	4.294	95	1.171	134	0.401
18	20.54	57	4.139	96	1.136	135	0.391
19	19.63	58	3.99	97	1.103	136	0.382

**Appendix 2: Resistance Table of Outdoor and Indoor Tube Temperature Sensors(20K)**

Temp. (°C)	Resistance (kΩ)	Temp. (°C)	Resistance (kΩ)	Temp. (°C)	Resistance (kΩ)	Temp. (°C)	Resistance(kΩ)
-19	181.4	20	25.01	59	5.13	98	1.427
-18	171.4	21	23.9	60	4.948	99	1.386
-17	162.1	22	22.85	61	4.773	100	1.346
-16	153.3	23	21.85	62	4.605	101	1.307
-15	145	24	20.9	63	4.443	102	1.269
-14	137.2	25	20	64	4.289	103	1.233
-13	129.9	26	19.14	65	4.14	104	1.198
-12	123	27	18.13	66	3.998	105	1.164
-11	116.5	28	17.55	67	3.861	106	1.131
-10	110.3	29	16.8	68	3.729	107	1.099
-9	104.6	30	16.1	69	3.603	108	1.069
-8	99.13	31	15.43	70	3.481	109	1.039
-7	94	32	14.79	71	3.364	110	1.01
-6	89.17	33	14.18	72	3.252	111	0.983
-5	84.61	34	13.59	73	3.144	112	0.956
-4	80.31	35	13.04	74	3.04	113	0.93
-3	76.24	36	12.51	75	2.94	114	0.904
-2	72.41	37	12	76	2.844	115	0.88
-1	68.79	38	11.52	77	2.752	116	0.856
0	65.37	39	11.06	78	2.663	117	0.833
1	62.13	40	10.62	79	2.577	118	0.811
2	59.08	41	10.2	80	2.495	119	0.77
3	56.19	42	9.803	81	2.415	120	0.769
4	53.46	43	9.42	82	2.339	121	0.746
5	50.87	44	9.054	83	2.265	122	0.729
6	48.42	45	8.705	84	2.194	123	0.71
7	46.11	46	8.37	85	2.125	124	0.692
8	43.92	47	8.051	86	2.059	125	0.674
9	41.84	48	7.745	87	1.996	126	0.658
10	39.87	49	7.453	88	1.934	127	0.64
11	38.01	50	7.173	89	1.875	128	0.623
12	36.24	51	6.905	90	1.818	129	0.607
13	34.57	52	6.648	91	1.736	130	0.592
14	32.98	53	6.403	92	1.71	131	0.577
15	31.47	54	6.167	93	1.658	132	0.563
16	30.04	55	5.942	94	1.609	133	0.549
17	28.68	56	5.726	95	1.561	134	0.535
18	27.39	57	5.519	96	1.515	135	0.521
19	26.17	58	5.32	97	1.47	136	0.509

**Appendix 3: Resistance Table of Outdoor Discharge Temperature Sensor(50K)**

Temp. (°C)	Resistance (kΩ)	Temp. (°C)	Resistance (kΩ)	Temp. (°C)	Resistance (kΩ)	Temp. (°C)	Resistance(kΩ)
-29	853.5	10	98	49	18.34	88	4.754
-28	799.8	11	93.42	50	17.65	89	4.609
-27	750	12	89.07	51	16.99	90	4.469
-26	703.8	13	84.95	52	16.36	91	4.334
-25	660.8	14	81.05	53	15.75	92	4.204
-24	620.8	15	77.35	54	15.17	93	4.079
-23	580.6	16	73.83	55	14.62	94	3.958
-22	548.9	17	70.5	56	14.09	95	3.841
-21	516.6	18	67.34	57	13.58	96	3.728
-20	486.5	19	64.33	58	13.09	97	3.619
-19	458.3	20	61.48	59	12.62	98	3.514
-18	432	21	58.77	60	12.17	99	3.413
-17	407.4	22	56.19	61	11.74	100	3.315
-16	384.5	23	53.74	62	11.32	101	3.22
-15	362.9	24	51.41	63	10.93	102	3.129
-14	342.8	25	49.19	64	10.54	103	3.04
-13	323.9	26	47.08	65	10.18	104	2.955
-12	306.2	27	45.07	66	9.827	105	2.872
-11	289.6	28	43.16	67	9.489	106	2.792
-10	274	29	41.34	68	9.165	107	2.715
-9	259.3	30	39.61	69	8.854	108	2.64
-8	245.6	31	37.96	70	8.555	109	2.568
-7	232.6	32	36.38	71	8.268	110	2.498
-6	220.5	33	34.88	72	7.991	111	2.431
-5	209	34	33.45	73	7.726	112	2.365
-4	198.3	35	32.09	74	7.47	113	2.302
-3	199.1	36	30.79	75	7.224	114	2.241
-2	178.5	37	29.54	76	6.998	115	2.182
-1	169.5	38	28.36	77	6.761	116	2.124
0	161	39	27.23	78	6.542	117	2.069
1	153	40	26.15	79	6.331	118	2.015
2	145.4	41	25.11	80	6.129	119	1.963
3	138.3	42	24.13	81	5.933	120	1.912
4	131.5	43	23.19	82	5.746	121	1.863
5	125.1	44	22.29	83	5.565	122	1.816
6	119.1	45	21.43	84	5.39	123	1.77
7	113.4	46	20.6	85	5.222	124	1.725
8	108	47	19.81	86	5.06	125	1.682
9	102.8	48	19.06	87	4.904	126	1.64

**Note: The information above is for reference only.**

## 10. Removal Procedure

### 10.1 Removal Procedure of Indoor Unit



#### Warning

Be sure to wait for a minimum of 10 minutes after turning off all power supplies before disassembly.

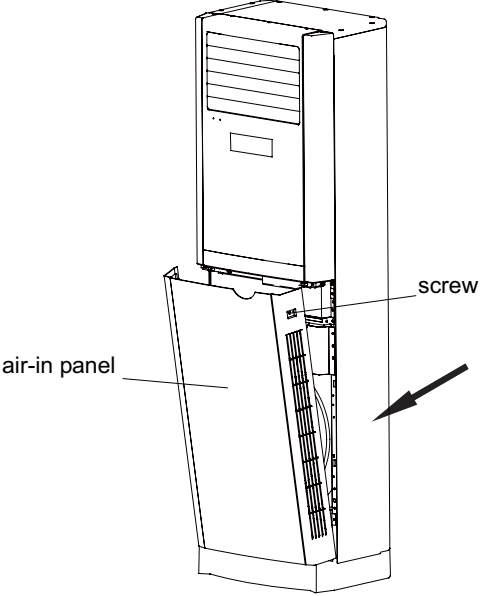
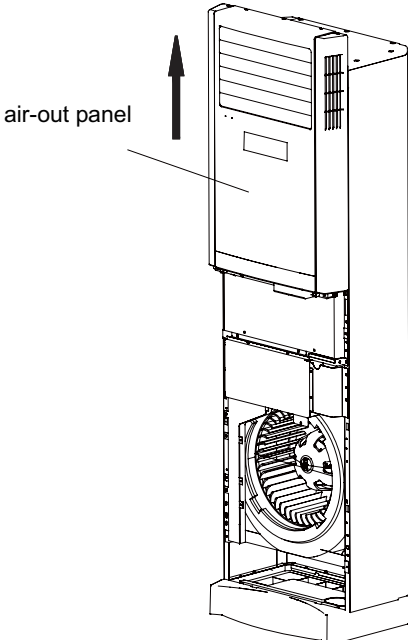
Steps	Procedure
<p>1. Remove air-in panel</p> <p>Remove screws fixing air-in panel and then remove air-in panel.</p>	
<p>2. Remove air-out panel</p> <p>Remove retaining screws on the top and bottom of the air-out panel. Then remove air-out panel.</p>	

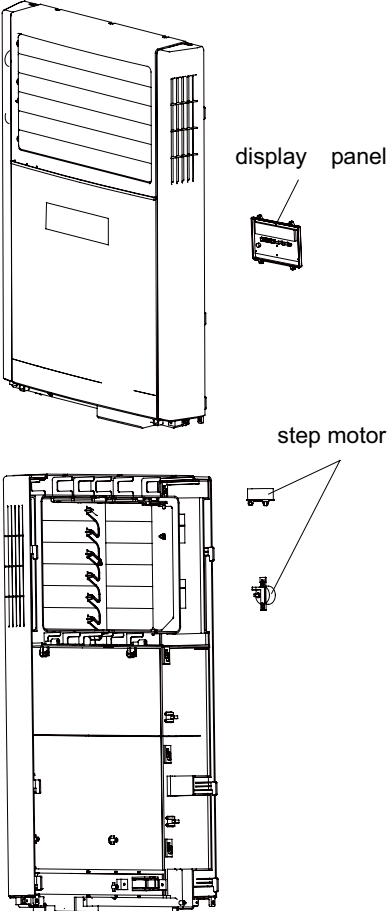
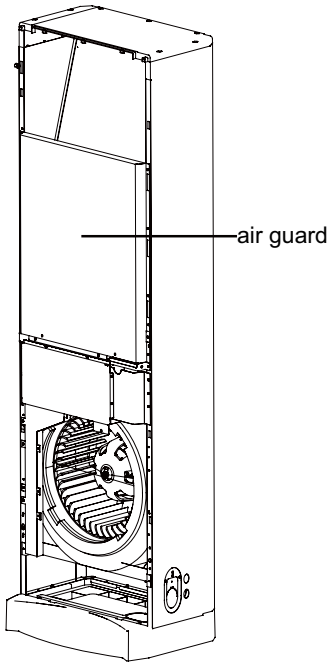
Steps	Procedure
<p>3. Remove display panel and step motor</p> <p>Remove retaining screws of controller box and the cover of controller box. Then remove the display panel. Remove screws fixing motor and then remove the step motor.</p>	 <p>The diagram illustrates the removal of the display panel and step motor. The top part shows the external view of the controller box with the display panel highlighted. The bottom part shows the internal view of the controller box with the step motor highlighted.</p>
<p>4. Remove air guard</p> <p>Remove retaining screws of air guard. Then remove the air guard.</p>	 <p>The diagram shows the air guard being removed from the front of the controller box. The air guard is shown as a rectangular panel that covers the front of the controller box.</p>

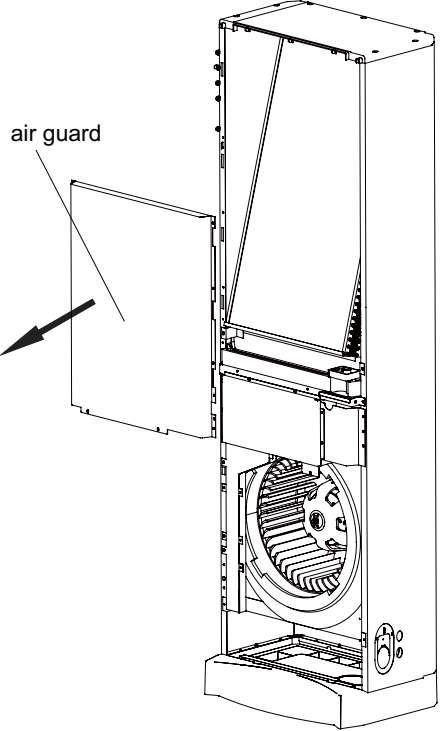
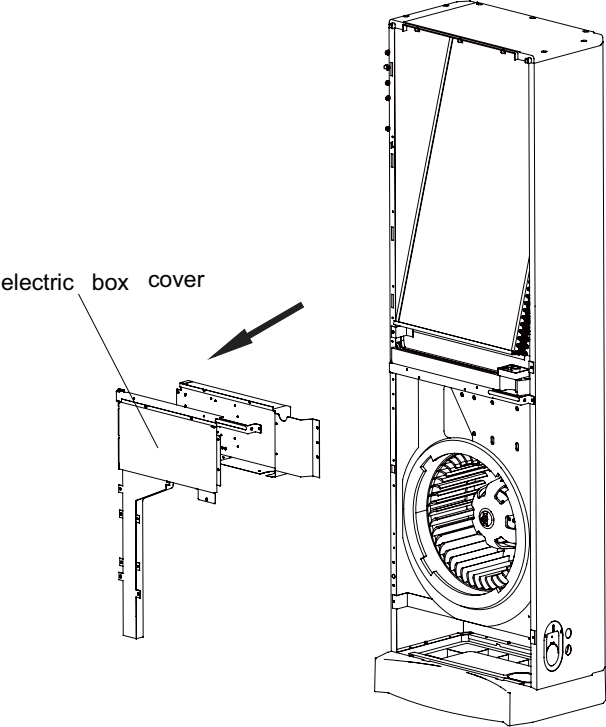

Steps	Procedure	
		
5.	Remove controller box	
	<p>Remove retaining screws of electric box cover and then remove the cover. Unplug each wiring terminal and remove components which need to be removed. Remove retaining screws of electric box and then remove the electric box.</p>	

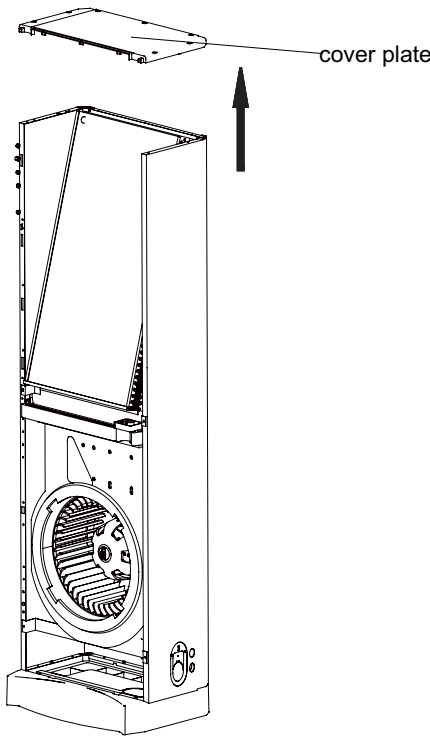
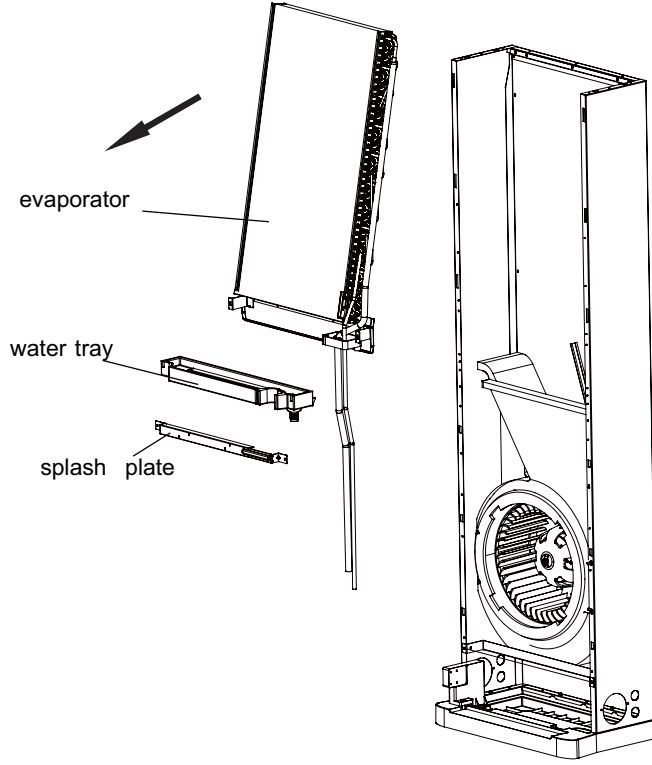
Steps	Procedure
<p>6. Remove cover plate</p>	<p>Remove screws fixing cover plate and then remove the plate.</p> 
<p>7. Remove evaporator</p>	<p>Remove retaining screws of connecting boards respective on the top and the bottom of evaporator. Then draw the side plate outwards to remove evaporator, splash plate and water tray. After removing evaporator, air guide and splash plate above evaporator can be removed.</p> 

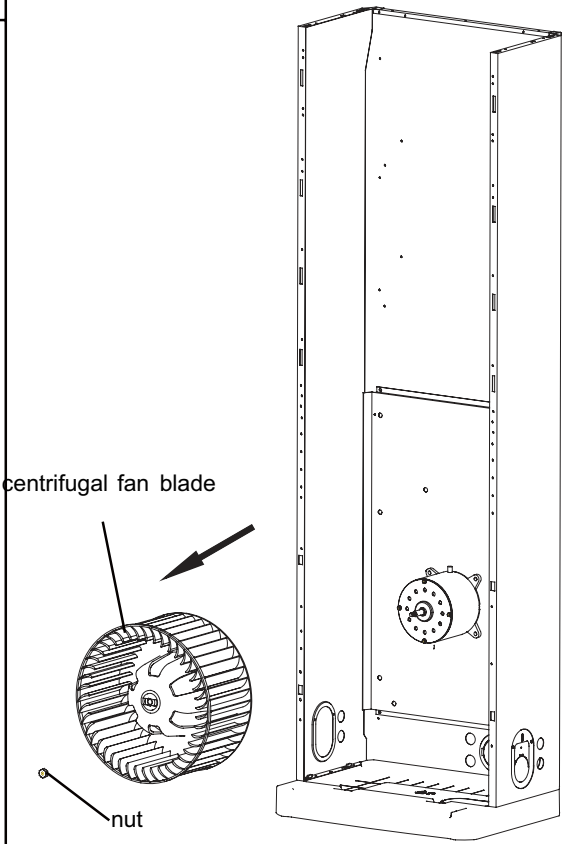
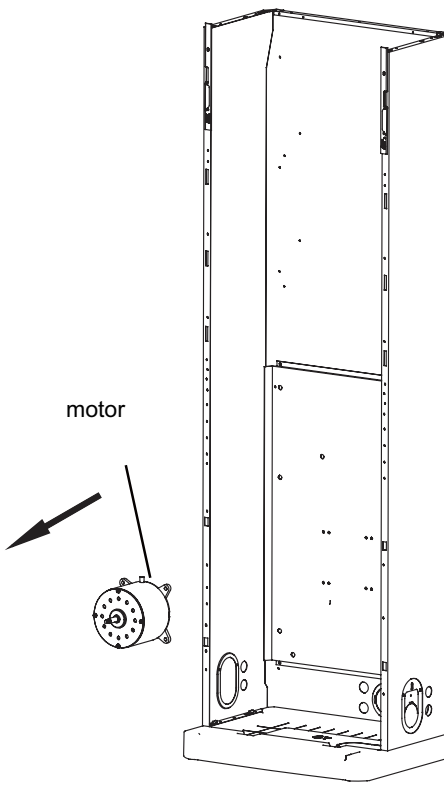

Steps	Procedure
<p>10. Remove centrifugal fan blade</p>	<p>Remove nut fixing centrifugal fan blade and then remove the fan blade.</p>  <p>centrifugal fan blade</p> <p>nut</p>
<p>11. Remove motor</p>	<p>Remove wire clamp on rear plate and then unplug motor wire. Remove screws fixing motor and then remove motor.</p>  <p>motor</p>

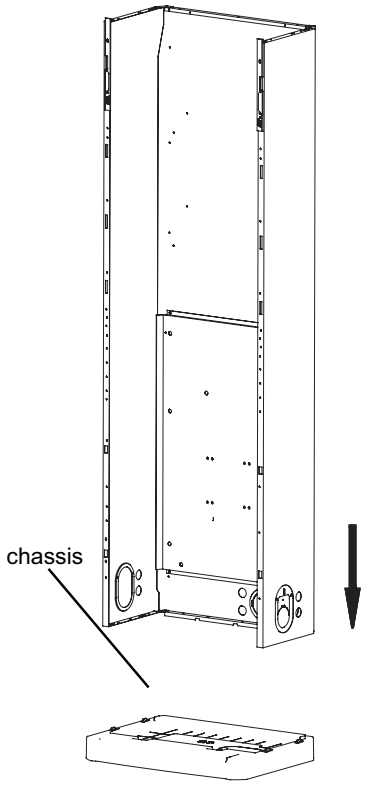
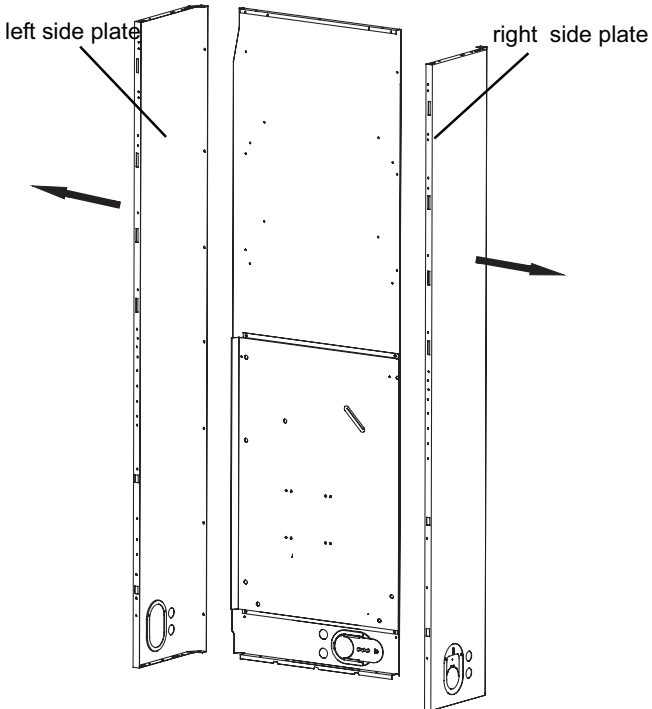
Steps	Procedure
<p data-bbox="119 286 343 313">12. Remove chassis</p> <p data-bbox="223 459 619 526">Remove screws fixing chassis and then remove the chassis.</p>	 <p data-bbox="869 873 949 907">chassis</p>
<p data-bbox="119 1198 502 1225">13. Remove right and left side plates</p> <p data-bbox="223 1344 619 1456">Remove screws fixing right and left side plates and then remove the side plates.</p>	 <p data-bbox="758 1265 901 1299">left side plate</p> <p data-bbox="1252 1265 1412 1299">right side plate</p>

## 10.2 Removal Procedure of Outdoor Unit



**Warning**

**Be sure to wait for a minimum of 10 minutes after turning off all power supplies before disassembly.**

Note: Electric heating band is not exemplified in the disassembly below.

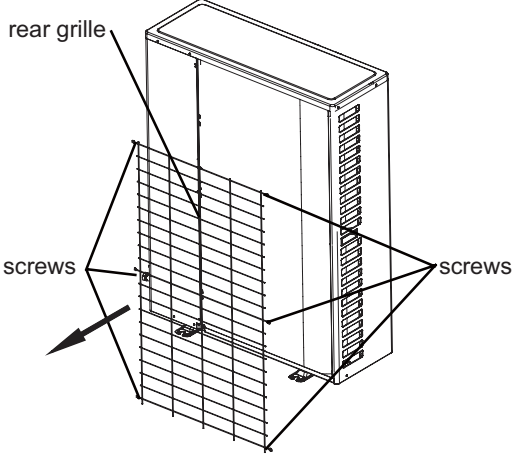
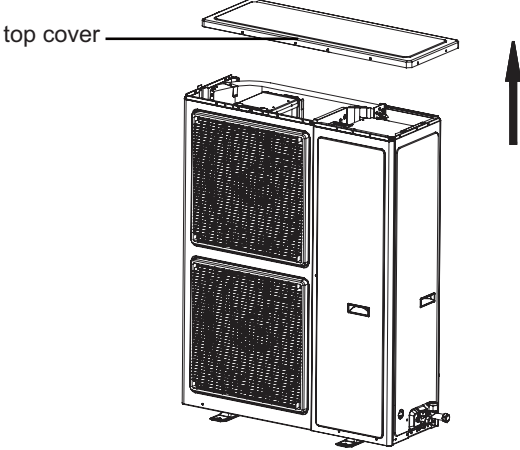
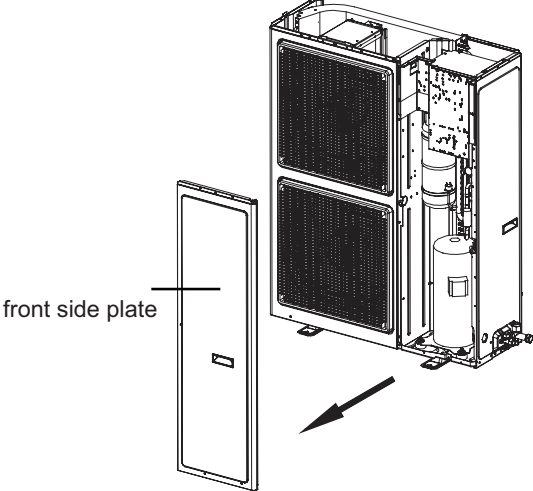
Steps	Procedure
<p>1. Remove the rear grille</p>	<p>Remove the tapping screws connecting the back grille with the back-side plate, the front case and the chassis. Remove the back grille.</p> 
<p>2. Remove the top cover</p>	<p>Remove the screws fixing the top cover. Raise the top cover to remove it.</p> 
<p>3. Remove the front side plate</p>	<p>Remove the 3 tapping screws fixing the front side plate. Take the front side plate outward to remove it.</p> 

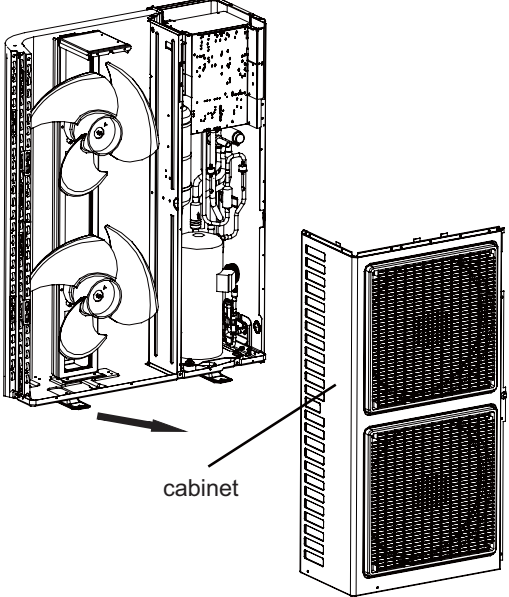
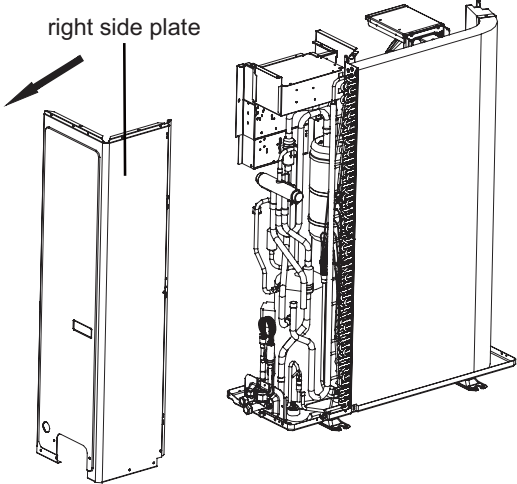
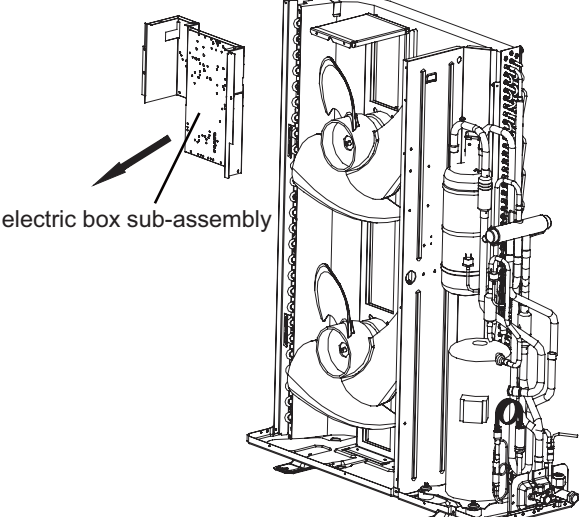
Steps	Procedure
<p>4. Remove the cabinet</p> <p>Remove the connecting screws fixing the cabinet. Remove the cabinet.</p>	
<p>5. Remove right side plate sub-assembly</p> <p>Remove the screws fixing the right side plate. Remove the right side plate.</p>	
<p>6. Remove electric box sub-assembly</p> <p>Remove the screws fixing the electric box cover. Disconnect the wire terminals and remove the electric box.</p>	

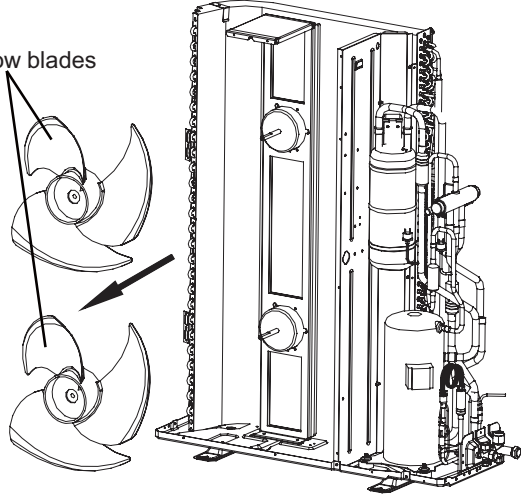
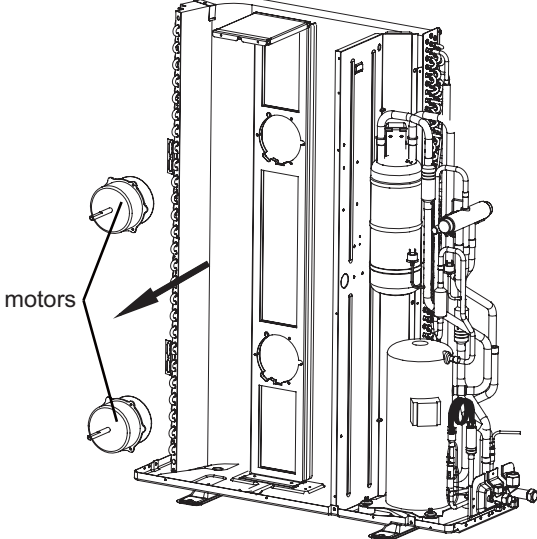
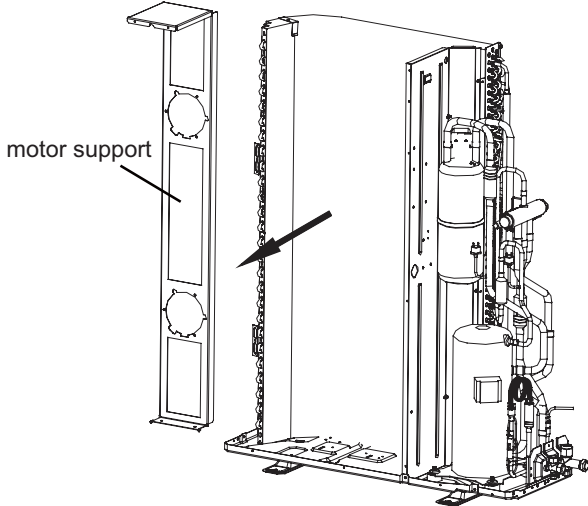
Steps	Procedure
7. Remove axial flow blades	<p data-bbox="715 365 895 394">axial flow blades</p> 
Remove the nut on the axial flow blades. Remove the blades.	
8. Remove the motors	
Remove the 4 screws fixing the motors. Disconnect the leading wire inserts of the motors. Remove the motors.	
9. Remove the motor support	
Remove the screws connecting the motor support and the chassis. Raise the motor support to remove it.	

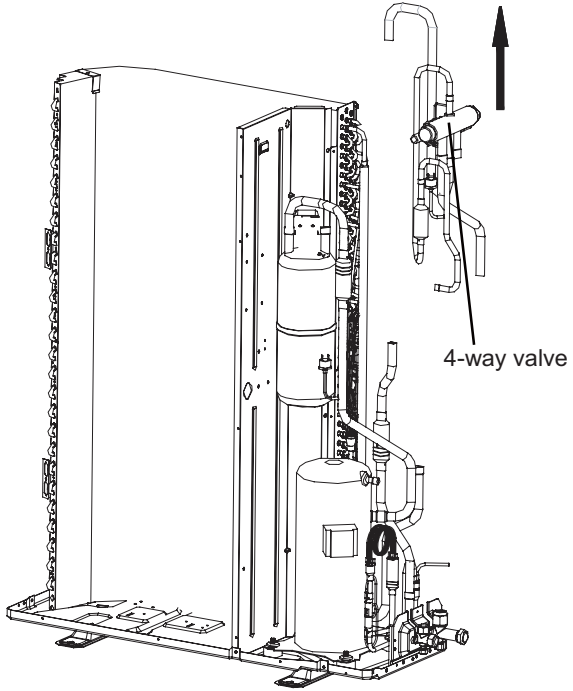
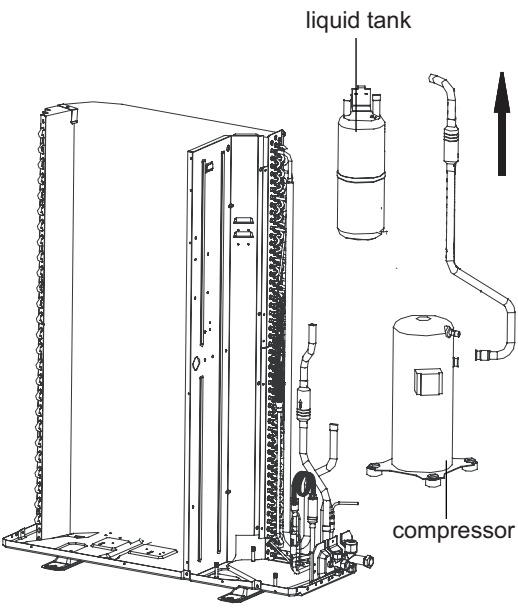

Steps	Procedure
<p>10. Remove the 4-way valve</p>	<p>(Only available for heat pump unit)                      Remove the nut on the 4-way valve coil and then remove the coil. Wrap the 4-way valve with a wet cloth. Unsolder the 4-way valve quickly and remove it. Ensure that the cloth keeps wet and do not burn the compressor lead. (Recover the refrigerant before unsoldering)</p> 
<p>11. Remove the compressor</p>	<p>Unsolder the pipes connected to the compressor and liquid tank. Remove the 4 foot bolts of the compressor. Raise the liquid tank and compressor to remove them.</p> 

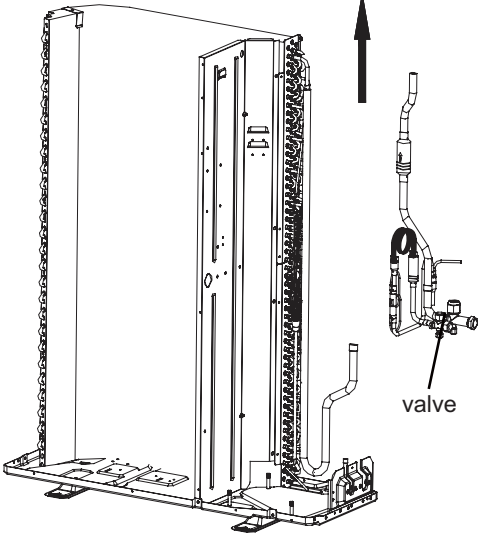
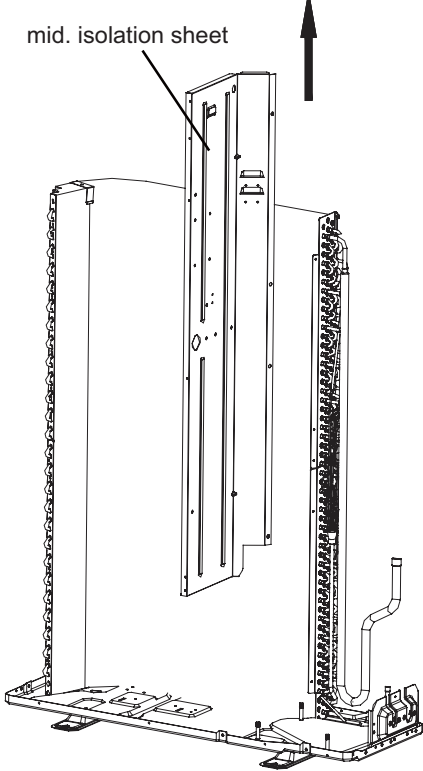
Steps	Procedure
12. Remove the valve	<p data-bbox="228 405 703 792">Remove the 2 bolts fixing the gas valve. Unsolder the welding joint between the gas valve and the return air pipe. Remove the gas valve. Remove the 2 bolts fixing the liquid valve. Unsolder the welding joint between the liquid valve and the Y-type connecting pipe. Remove the liquid valve. (Note: During unsoldering, wrap the gas valve with a wet cloth to avoid damage to the valve caused by high temperature.)</p> 
13. Remove the mid. isolation sheet	<p data-bbox="233 1144 699 1279">Remove the screws connecting the isolation sheet with the right side plate of condenser and the chassis. Remove the mid. isolation sheet.</p> 

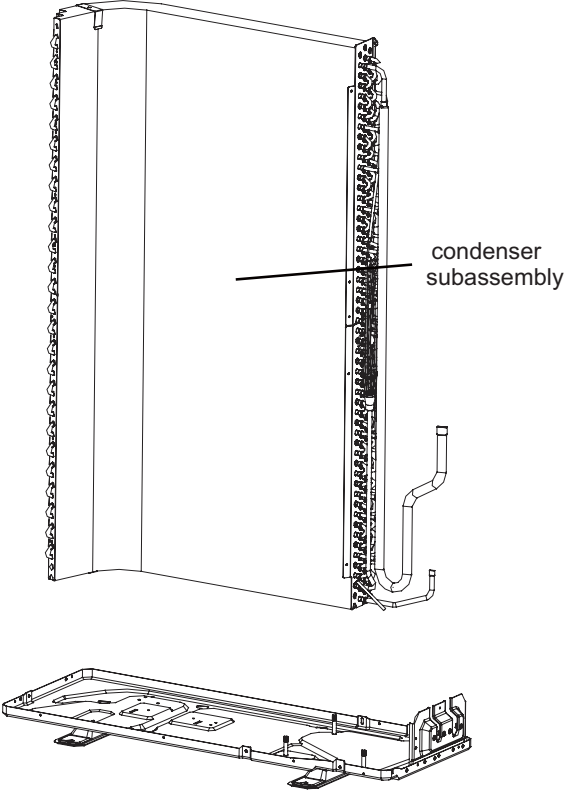
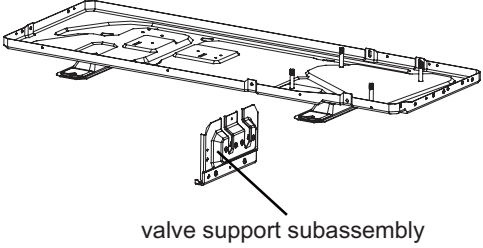
Steps	Procedure
<p data-bbox="121 309 512 338">14. Remove condenser subassembly</p> <p data-bbox="240 398 639 506">Remove the screws connecting the condenser and the chassis. Raise the condenser subassembly to remove it.</p>	 <p>The diagram illustrates the removal of the condenser subassembly. It shows a side view of the condenser subassembly, which is a long, vertical, rectangular unit with a complex internal structure. A label 'condenser subassembly' with a leader line points to the unit. Below it, a perspective view of the chassis is shown, with the condenser subassembly being lifted away from it. The chassis is a flat, rectangular metal plate with various mounting points and components.</p>
<p data-bbox="121 1263 544 1292">15. Remove valve support subassembly</p> <p data-bbox="228 1352 683 1460">Remove the screw connecting the valve support and the chassis. Remove the valve support subassembly.</p>	 <p>The diagram illustrates the removal of the valve support subassembly. It shows a perspective view of the chassis, which is a flat, rectangular metal plate. A label 'valve support subassembly' with a leader line points to a small, rectangular component mounted on the chassis. The component has a screw hole and a small protrusion.</p>



**GREE ELECTRIC APPLIANCES,INC.OF ZHUHAI**

---

Add: Jinji west Rd. Qianshan Zhuhai Guangdong China  
Tel: 86-756-8522219 (After sale Service Dept)  
Post code : 519070