



Installation and Operation Manual

**Multi-VRF Centralized Controller
CE51-24/E(M)**

GREE ELECTRIC APPLIANCES, INC. OF ZHUHAI

Please read this manual carefully before using this product and keep it properly for future reference.

Users Notice

Please carefully read this manual before operate the product.

- a. Never install the centralized controller at the place having corrosive gas, heavy dust, salt fog or moisture, or under the sunlight directly.
- b. If the unit is installed at the place having electromagnetism interference, signal wire and communication wire should be shielding twisted pair wire.
- c. For normal communication, ensure proper connection of communication wire and correct dialing of DIP switch in communication module.
- d. Never knock, throw or frequently disassemble the centralized controller.
- e. Never operate the centralized controller with wet hand.

Contents

I Summary 1

1.1 Brief introduction of function 1

1.2 Communication network 1

II Display Part 2

2.1 LCD display 2

2.2 Introduction to LCD display 3

III Buttons 4

3.1 Silk screen 4

3.2 Instruction to functions of buttons 4

IV Control method 5

4.1 Single control 5

4.2 Central control 5

4.3 Group control 5

V Operation Instruction 5

5.1 Unit on/off 5

5.2 Mode setting 5

5.3 Temperature setting 5

5.4 Fan speed setting 6

5.5 Clock setting 6

5.6 Swing function setting 7

5.7 Grouping of indoor units 7

5.8 Shield Function Setting 7

5.8.1 Single shield setting 8

5.8.2 Center shield setting 9

5.8.3 Group Shield Setting 10

5.9 Weekly TIMER Setting 11

5.9.1 Single timer setting 12

5.9.2 Center timer setting 13

5.9.3 Group timer setting 15

5.10 Checking Function 17

VI Installation and Debugging 17

6.1 Installation 17

6.2 Connection between centralized controller and communication module 21

6.3 Debugging 22

6.3.1 Address setting of communication module 22

6.3.2 Debugging 23

VII Attachment 24

I Summary

1.1 Brief introduction of function

Used in multi-VRF system, a set of centralized controller can connect with 64 communication modules to control 1024 sets of indoor units. Through it, indoor unit's ON/OFF, operation mode, set temperature, fan speed, swing state etc. can be checked and controlled. This device can realize single/group/central control and conveniently manage the air conditioners through weekly timer and long-distance shielded setting.

- a. Single control can control a single unit;
- b. Group control can control a preset group of indoor units;
- c. Central control can control all indoor units;
- d. Single/group/central shielded is to shielded the operation parameters of indoor units from long distance;
- e. Single/group/central weekly timer is to set TIMER ON/OFF of the air conditioner from long distance;
- f. Clock setting is to set week, hour and minute and let them show;

The centralized controller can automatically detect the online "region" and indoor unit and display present indoor unit's operation mode, set temperature, fan speed, swing, weekly timer, shield, etc. For the purpose of quick inspection, upon malfunction of any indoor unit, its corresponding error code and region No. will be displayed and blink. The centralized controller integrating multiple communication modules makes up a communication network. Without repeaters, the communication wires's distance can be up to 1km.

1.2 Communication network

Sketch map of communication network:

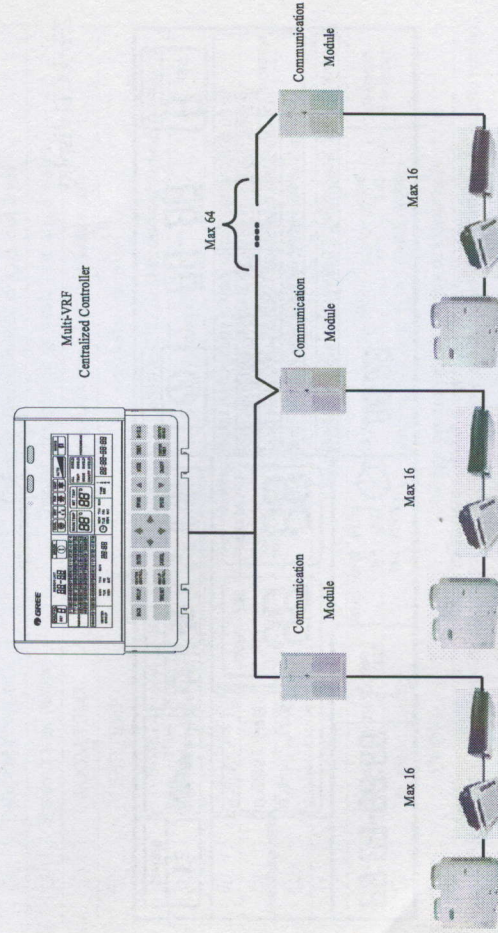

Fig. 1 Sketch map of communication network

Before normal operation of the centralized controller, the technician must set address of the communication system and perform debugging.

II Display Part

2.2 Introduction to LCD display

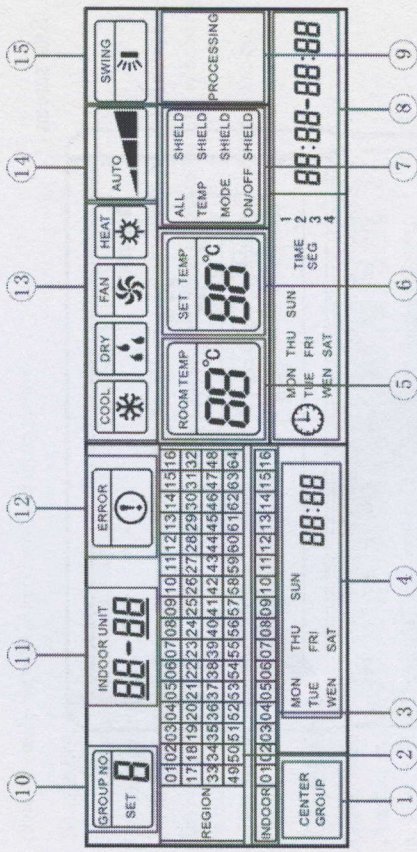

Fig. 4

Table 1 Instruction to LCD graphic

No.	Description	Instruction to Displaying Contents
①	CENTER/GROUP	"GROUP" displayed during group control operation or grouping indoor units "CENTER" displayed during center control, center shield or center timer operation
②	REGION NO.	Online or selected region No. displayed(Note 1)
③	INDOOR UNIT NO.	Online or selected indoor unit no. displayed
④	System's time display	Display present time by week, hour and minutes
⑤	ROOM TEMP	Room temperature of present indoor unit
⑥	SET TEMP	Set temperature display
⑦	SHIELD	All/temperature/mode/on/off shield from long distance
⑧	Timer setting display	Weekly timer display
⑨	PROCESSING	Displayed during sending out control command
⑩	GROUP NO.	Group No. display
⑪	INDOOR UNIT	Display region No. and unit no. of present indoor unit
⑫	ERROR	Error display upon malfunction of any unit
⑬	Operation mode	Operation mode display of indoor unit
⑭	Fan speed display	High, medium, low or auto fan speed display
⑮	SWING	Swing operation mode display of indoor unit

Note 1: All indoor units connected by one communication module are automatically distributed in one region.

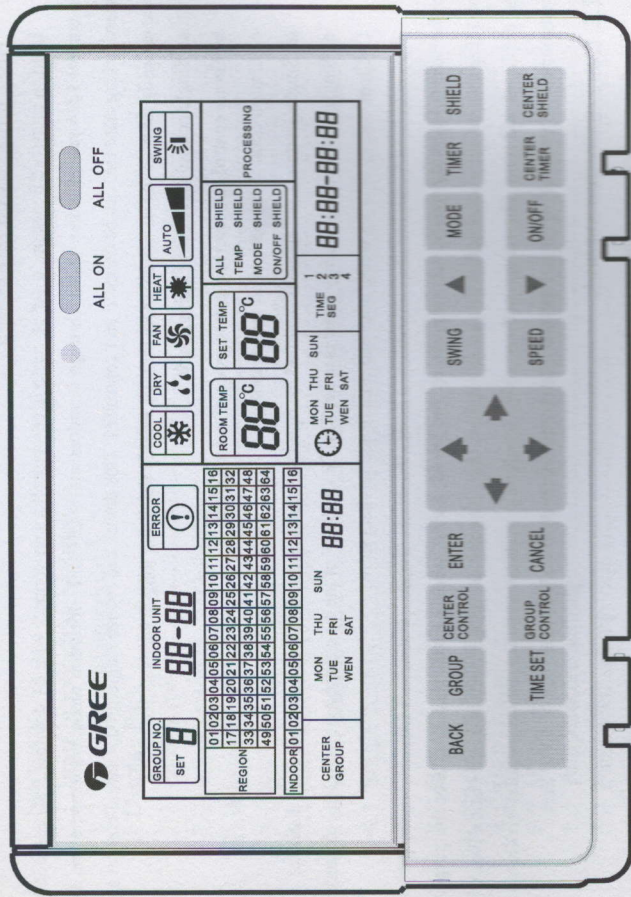

Fig. 2 Appearance

2.1 LCD display

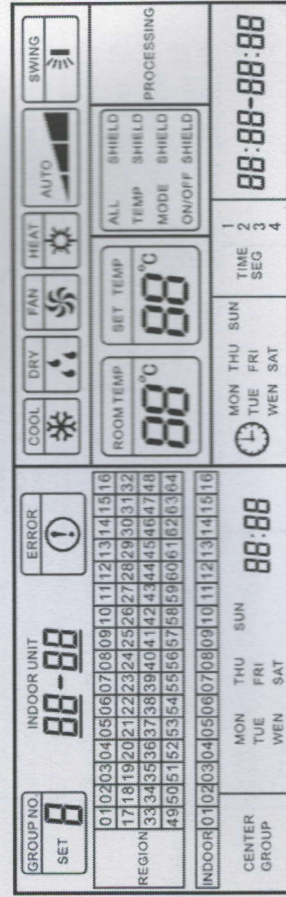

Fig. 3 Sketch map of LCD

III Buttons

3.1 Silk screen

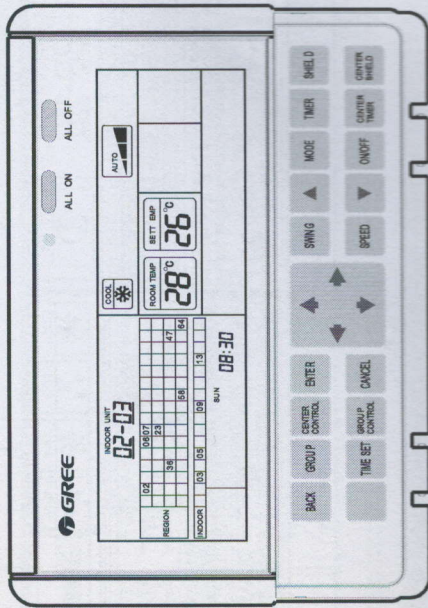

Fig.5 Silk screen of the buttons

3.2 Instruction to functions of buttons

Table 2 Instruction to buttons

No.	Description	Function
1	ALL ON	Start up all indoor units
2	ALL OFF	Stop all indoor units
3	BACK	Back to the previous menu of current display.
4	GROUP	Press this button in check state to check and set group information
5	TIME SET	Set system clock
6	CENTER CONTROL	Uniformly control the operation parameters of all indoor units
7	GROUP CONTROL	Uniformly control the operation parameters of one group of indoor units
8	ENTER	Press this button during function setting to confirm the setting
9	CANCEL	Press this button during function setting to cancel the setting. For example, press CANCEL button when CENTER CONTROL has been set, the state will go back to selection of control method.
10	UP/DOWN LEFT/RIGHT	For direction indication. For example, press these buttons in state to select the indoor unit or communication modules to be queried.
11	SWING	Set swing or not
12	SPEED	Set high,medium,low or auto fan speed
13	▲ Increase	Increase set temperature
14	▼ Decrease	Decrease set temperature
15	MODE	Set COOL,DRY,FAN or HEAT mode
16	ON/OFF	Set unit on or off
17	TIMER	Set or check timer
18	CENTER TIMER	Centrally set or check timer
19	SHIELD	Shield functions of a single or a group of indoor unit/s
20	CENTER SHIELD	Centrally shield functions of all indoor units

IV Control method

There are single control, central control and group control.

4.1 Single control

Single control is to control the operation parameters of a single indoor unit. Operation as follow:

- Press LEFT/RIGHT button to switch between "REGION" and "INDOOR". Press UP/DOWN button to adjust region no. and indoor unit no. in order to select the indoor units to be controlled. The selected region no. and indoor unit no. blink.
- Set indoor unit operation states including mode, fan speed, temperature, timer, shield and so on.
- Press BACK button during setting operation to go back into checking state.

4.2 Central control

Center control is to uniformly control the operation parameters of all indoor units. Operation as follow:

- Pressing CENTER CONTROL button, CENTER is displayed.
- Set indoor unit operation states including mode, fan speed, temperature, timer, shield and so on.
- Press BACK button during setting operation to go back into checking state.

4.3 Group control

Group control is to uniformly control the operation parameters of one group of indoor units. Operation as follow:

- Pressing GROUP CONTROL button, GROUP is displayed.
- Set indoor unit operation states including mode, fan speed, temperature, timer, shield and so on.
- Press BACK button during setting operation to go back into checking state.

V Operation Instruction

5.1 Unit on/off

There are ALL ON, ALL OFF and ON/OFF buttons.

Press ALL ON button one second to start up all indoor units.

Press ALL OFF button one second to stop all indoor units.

Press ON/OFF button to start up a single or some indoor unit/s

Press ON/OFF button again to stop a single or some indoor unit/s

Note: The indoor unit will be turned off in the event of changing status from power off to power on, the indoor unit will be turned on with the default setting under the first ALL ON control.

5.2 Mode setting

Each pressing of MODE button changes the operation mode according to the below sequence:

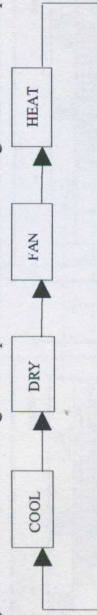

Fig.6

5.3 Temperature setting

Pressing ▲ button at unit ON increases set temperature or ▼ button decreases set temperature.

Pressing ▲ or ▼ button above 1 second rapidly changes the set temperature.

The temperature setting range in each mode is 16°C~30°C.

5.4 Fan speed setting

Each pressing of SPEED button changes the fan speed in sequence:

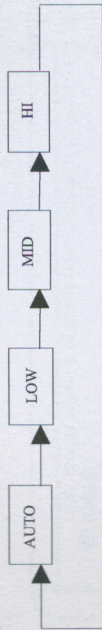

Fig. 7

5.5 Clock setting

System clock provides time basis for weekly timer by which week, hour and minute items can be set. Operation as follows:

- Press TIME SET button to go to the clock setting state with the present date blinking (default).
 - Pressing UP/DOWN button adjusts the date.
 - Pressing RIGHT button switches to hour setting and pressing UP/DOWN button adjusts the hour.
 - Pressing RIGHT button switches to minute setting and pressing UP/DOWN button adjusts the minute.
- Note: Either pressing TIME SET or BACK button during clock setting can quit and go back into check state.

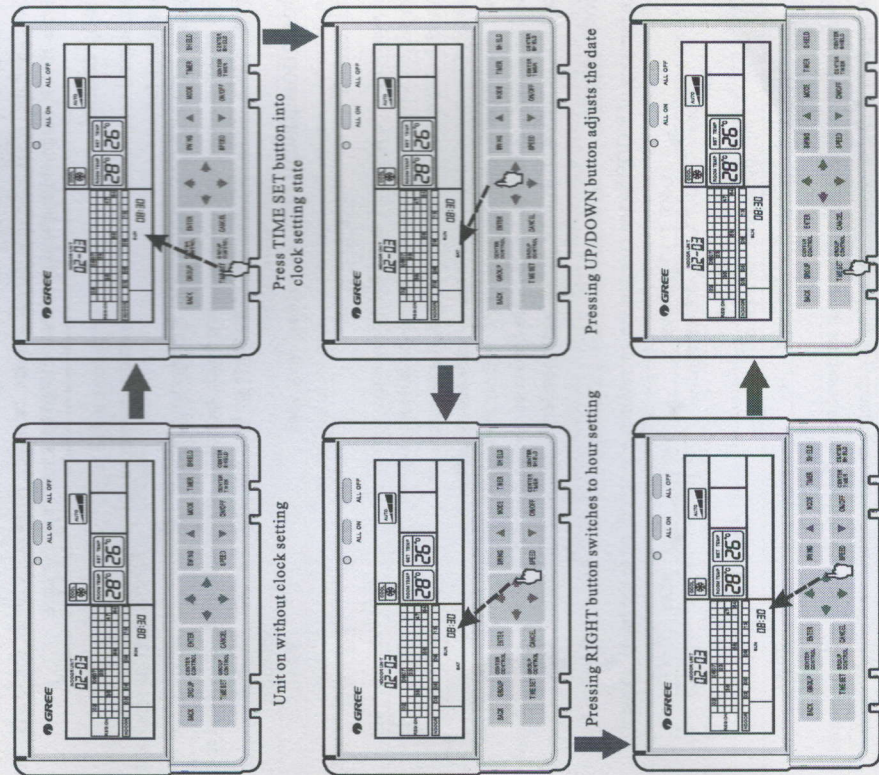

Fig. 8

5.6 Swing function setting

Press SWING button at unit ON to start swing function, LCD displaying swing icon. During swing operation, press SWING button to stop swing function and the swing icon disappears.

5.7 Grouping of indoor units

Operation as follows:

- Press GROUP button, LCD displaying "SET".
- Pressing UP/DOWN button adjusts group No.
- Press RIGHT button for region selection, min. region No. blinking (default). Press ENTER or CANCEL button to confirm or cancel the setting. The selected region number will be displayed as well as the corresponding indoor unit number.
- Press RIGHT button for indoor unit selection, min. indoor unit No. blinking (default). Press ENTER or CANCEL button to confirm or cancel the setting. The selected indoor unit number will be displayed as well as the region number.
- Pressing LEFT button goes back to region No. selection. Pressing LEFT button again goes back to group No. adjustment.

Note: During Group of indoor units setting, pressing GROUP or BACK button can quit from Group setting.

When the central controller or the communication module for which the grouping of indoor units has been set is going to be used for a new project, the setting should be initialized (during the initialization, the set grouping information will be cleared) and then the grouping setting can be down again.

Initialization: Before the central controller is powered on, press the button below the button BACK to go the initialization setting page and the initialization will ten seconds.

5.8 Shield Function Setting

Shield method includes single shield, central shield and group shield.

Shielded function includes "ALL SHIELD", "TEMP SHIELD", "MODE SHIELD" and "ON/OFF SHIELD".

- "ALL SHIELD" means locking present setting state (temperature, mode and on/off state), so that the adjustment of them is not available.
- "TEMP SHIELD" means locking preset temperature setting, so that temperature adjustment is not available.
- "MODE SHIELD" means locking preset mode setting, so that mode adjustment is not available.
- "ON/OFF SHIELD" means locking present on/off setting, so that on/off control is not available.

During shielding operation:
If "TEMP SHIELD", "MODE SHIELD" or "ON/OFF SHIELD" after "ALL SHIELD" has been set, "ALL SHIELD" function will be automatically canceled.

If "ALL SHIELD" after "TEMP SHIELD", "MODE SHIELD" or "ON/OFF SHIELD" has been set, "TEMP SHIELD", "MODE SHIELD" or "ON/OFF SHIELD" function will be automatically canceled.

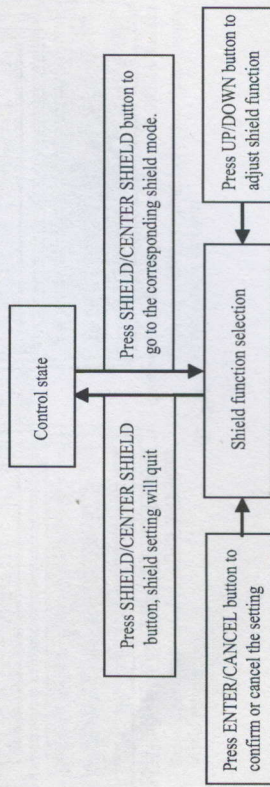

Fig. 9 Flowchart of shield setting

5.8.1 Single shield setting

Operation as follow:

- Press SHIELD button to go to the shield setting with the last settingshield function blinking.
- Press UP/DOWN button to select among "ALL SHIELD", "TEMP SHIELD", "MODE SHIELD" and "ON/OFF SHIELD. The corresponding shielded function blinks.
- Press ENTER button to confirm the setting. Present shield function is normally on.
- Press CANCEL button to cancel present shield setting.

Note:During single shielding setting, pressing SHIELD or BACK button can quit from shield setting.

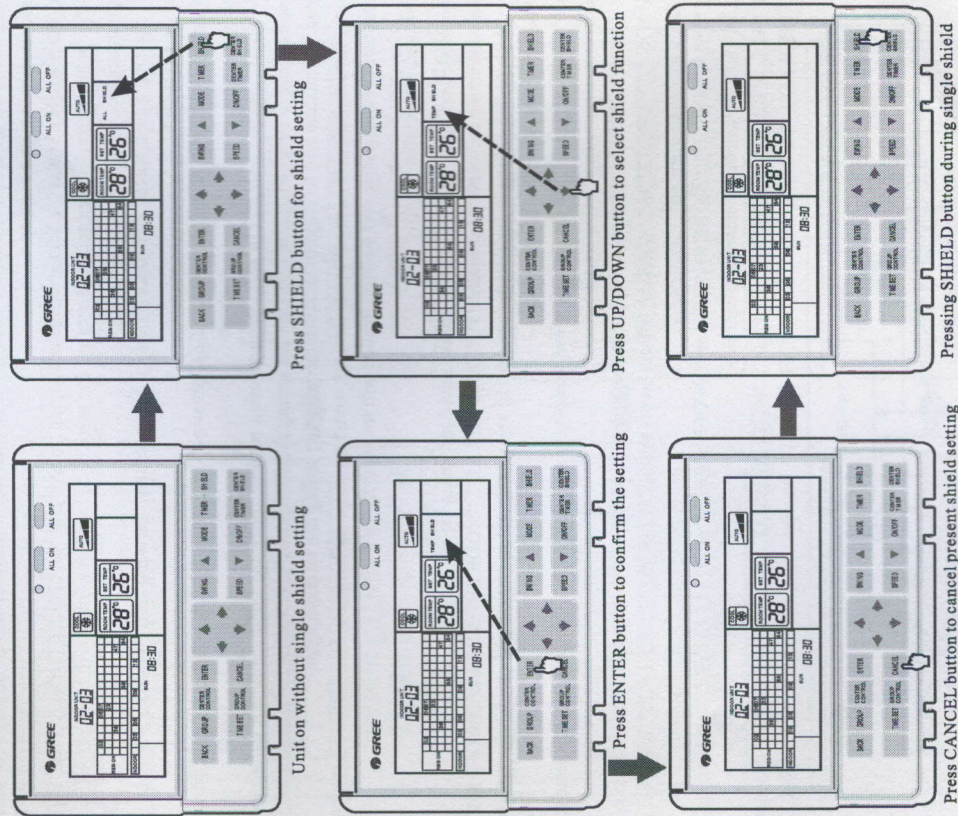

Fig. 10

5.8.2 Center shield setting

Operation as follow:

- Press CENTER SHIELD button to go to the center shielded setting with the last setting shield function blinking.
- Press UP/DOWN button to select among "ALL SHIELD", "TEMP SHIELD", "MODE SHIELD" and "ON/OFF SHIELD. The corresponding shielded function blinks.
- Press ENTER button to confirm the setting. Present shield function is normally on.
- Press CANCEL button to cancel present shield setting.

Note:During center shielding setting, pressing CENTER SHIELD or BACK button can quit from shield setting.

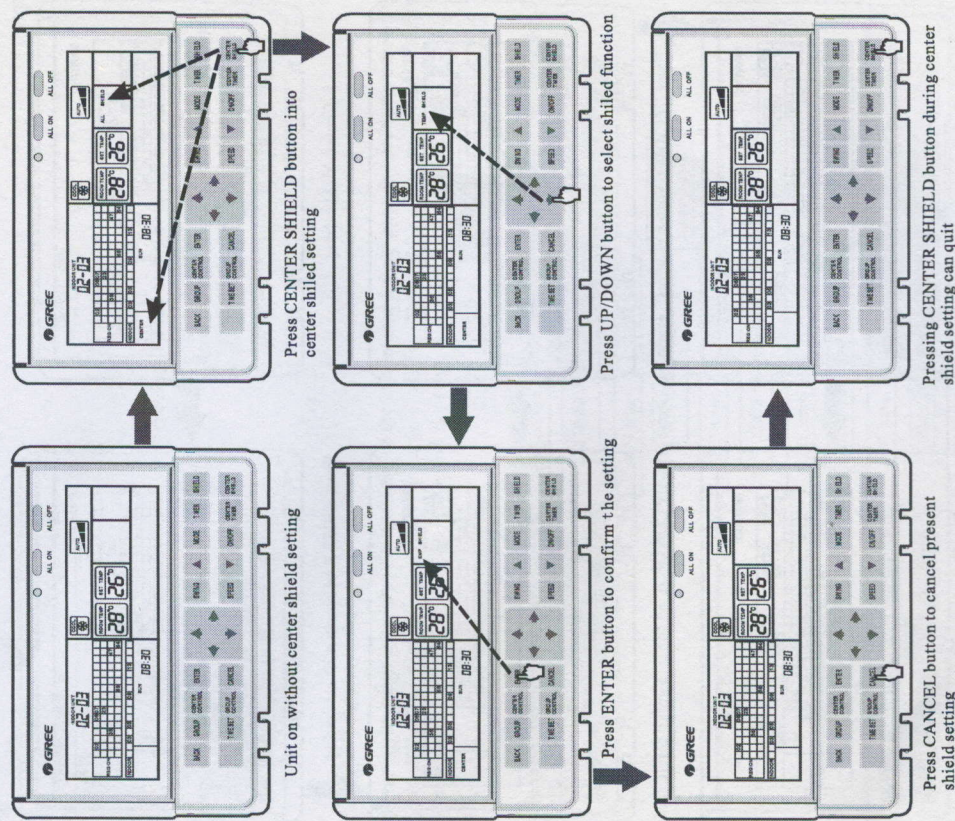

Fig. 11

5.8.3 Group Shield Setting

Operation as follow:

- Press SHIELD button for shielded setting with the last setting shield function blinking.
- Press GROUP CONTROL button into group shield setting, LCD displaying group No. Press UP/DOWN button to adjust group No. and press ENTER button to confirm the selection.
- Press RIGHT button to select shielded function. Press UP/DOWN button to select among "ALL SHIELD", "TEMP SHIELD", "MODE SHIELD" and "ON/OFF SHIELD". The present shielded function blinks.
- Press ENTER button to confirm present shield setting, present shield function normally on.
- Press CANCEL button to cancel present shield setting.

Note: During group shielding operation, pressing SHIELD or BACK button can quit from group shield setting.

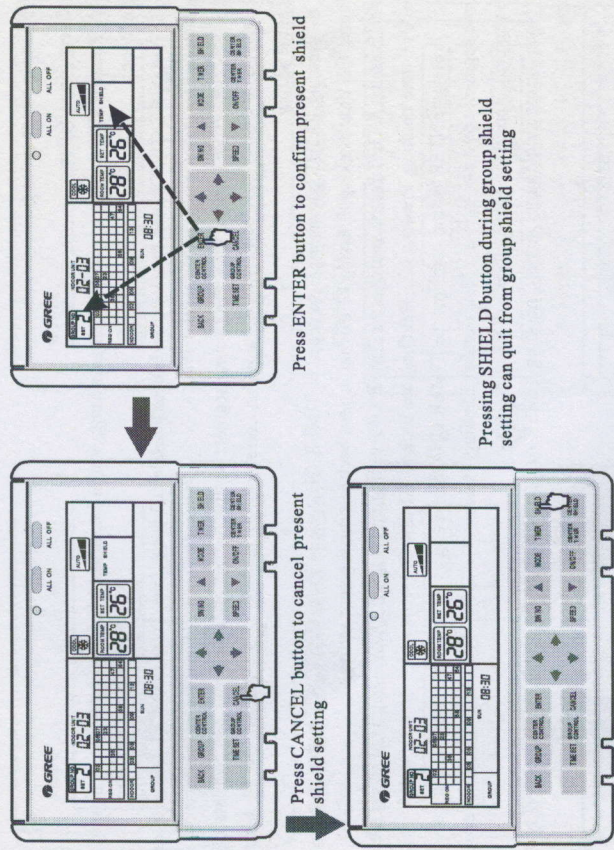
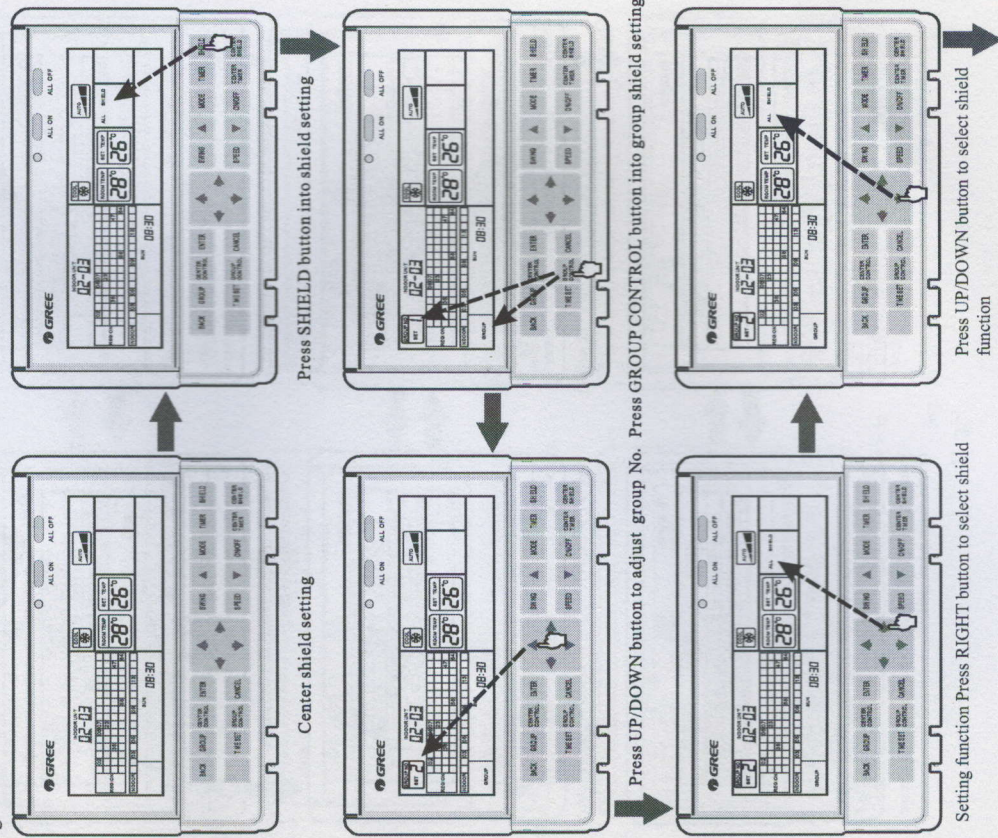

Fig. 12

5.9 Weekly TIMER Setting

On one week's basis, set Timer ON and OFF of the unit on one day or some days of this week. Upon this setting, the unit will be circularly and timely turned on or off. For example, the unit starts operation at 8:00 and stops operation at 17:00 from Monday to Friday and stops operation from Saturday to Sunday.

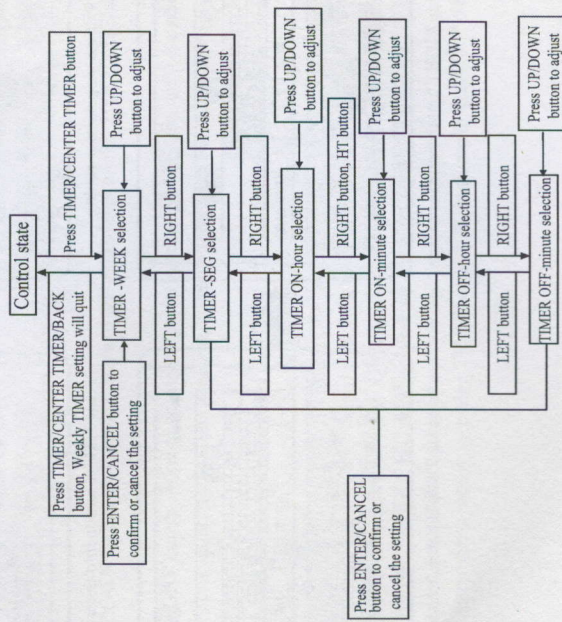

Fig. 13 Flowchart of weekly timer setting

5.9.1 Single timer setting

Operation as follow:

- Press TIMER button to go to the timer setting, the present date blinking (default) and setting date normally on.
- Press UP/DOWN button to select the date and the selected one blinks. Press CANCEL button to cancel the date setting.
- Pressing RIGHT button switches to time segment setting. In this case, only the selected date blinks. Press UP/DOWN button to adjust the time segment, corresponding number blinks. Press CANCEL button to cancel the setting.
- Pressing RIGHT button again switches to TIMER ON setting. Press UP/DOWN button to adjust the ON time, ON time blinking. Pressing LEFT button goes back to time segment setting.
- Pressing RIGHT button switches to TIMER OFF setting. Pressing UP/DOWN button to adjust the OFF time, OFF time blinking. Pressing LEFT button goes back to TIMER ON setting.
- Pressing ENTER button confirms the TIMER ON/OFF setting at present time segment and goes back to time segment selection, the next SEG number blinking. Pressing UP/DOWN button continues selection of time segment. Repeat the above procedure for next setting.

Note: During single timer setting, pressing TIMER or BACK button can quit from single weekly timer setting.

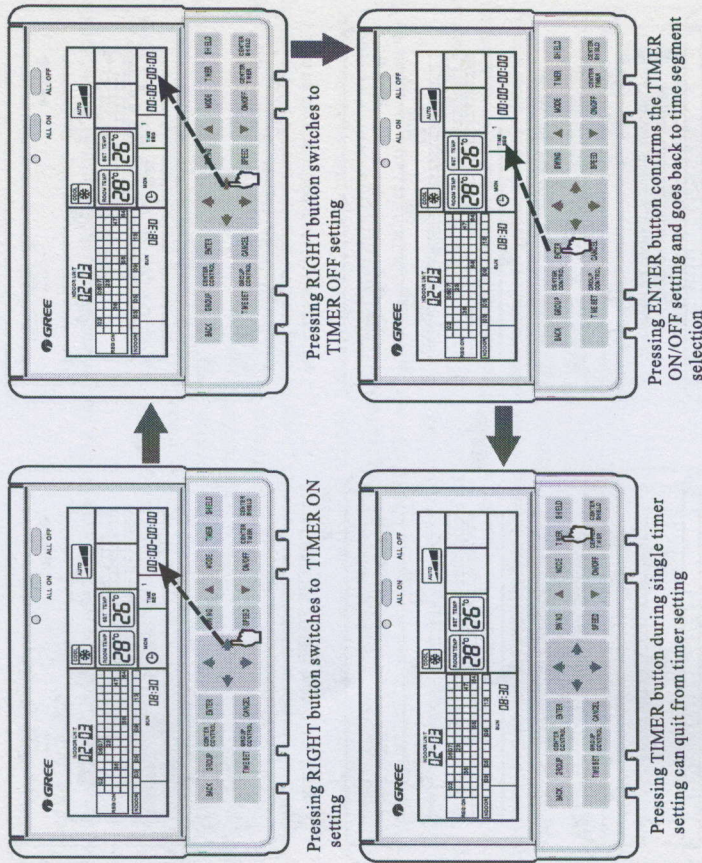
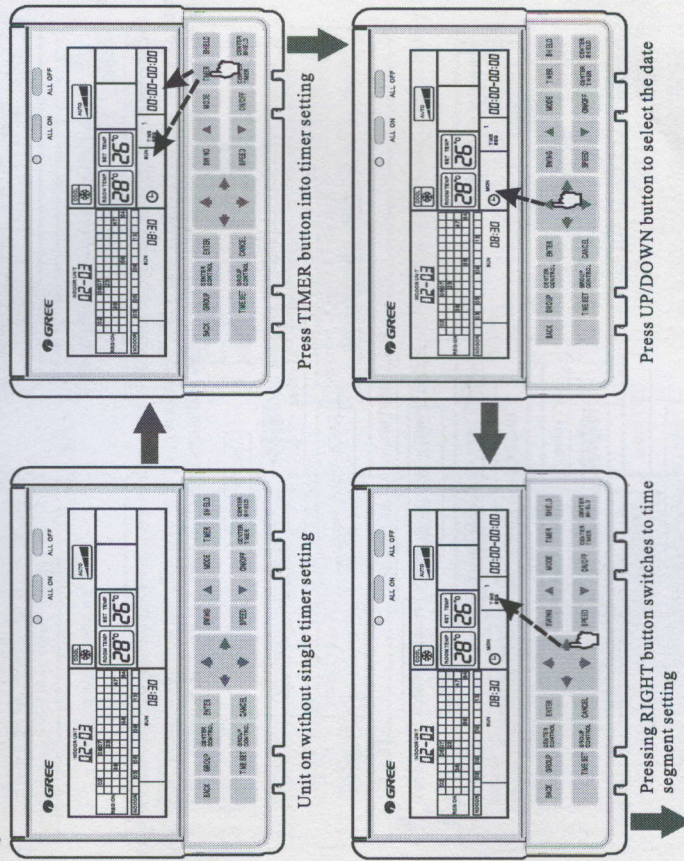

Fig. 14

5.9.2 Center timer setting

Operation as follow:

- Press CENTER TIMER button into timer setting, the present date blinking (default) and setting dates normally on.
- Press UP/DOWN button to select the date and the selected one blinks. Press CANCEL button to cancel the date setting.
- Pressing RIGHT button switches to time segment setting. In this case, only the selected date blinks. Press UP/DOWN button to adjust the time segment, corresponding number blinks. Press CANCEL button to cancel the setting.
- Pressing RIGHT button again switches to TIMER ON setting. Press UP/DOWN button to adjust the ON time, ON time blinking. Pressing LEFT button goes back to time segment setting.
- Pressing RIGHT button switches to TIMER OFF setting. Pressing UP/DOWN button to adjust the OFF time, OFF time blinking. Pressing LEFT button goes back to TIMER ON setting.
- Pressing ENTER button confirms the TIMER ON/OFF setting at present time segment and goes back to time segment selection, the next SEG number blinking. Pressing UP/DOWN button continues selection of time segment. Repeat the above procedure for next setting.

Note: During center timer setting, pressing TIMER or BACK button can quit from center weekly timer setting.

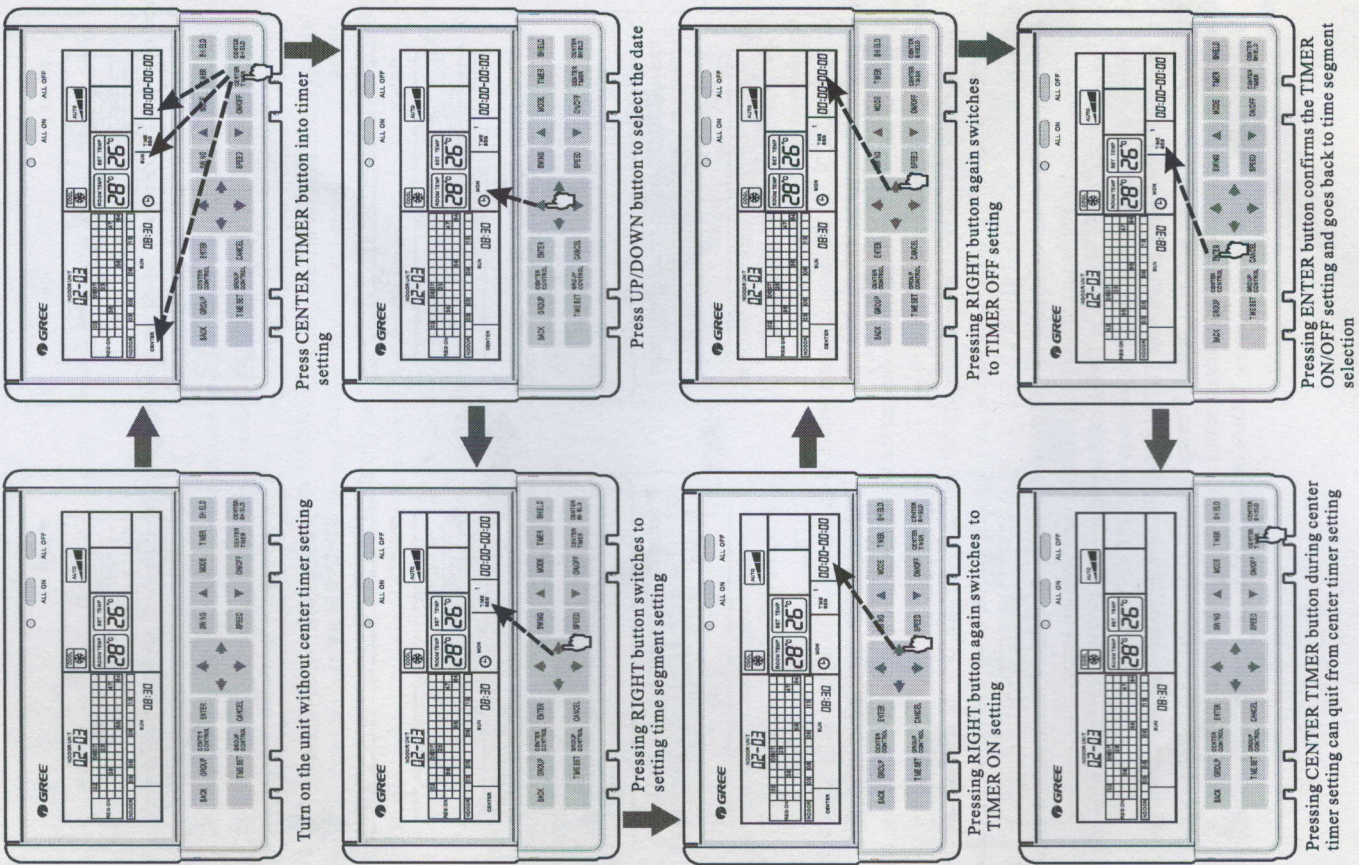

Fig. 15

5.9.3 Group timer setting

Operation as follows:

- Press TIMER button to go to the timer setting, the present date blinking (default) and setting dates normally on.
- Press GROUP CONTROL button for group timer setting, LCD displaying present group No. Press UP/DOWN button to adjust group No., the No. blinking. Press CANCEL button to cancel this setting.
- Pressing RIGHT button switches to date selection. Press UP/DOWN button to select the date and the selected one blinks. Press CANCEL button to cancel the date setting.
- Pressing RIGHT button switches to time segment setting. In this case, only the selected date blinks. Press UP/DOWN button to adjust the time segment, corresponding number blinks. Press CANCEL button to cancel the setting.
- Pressing RIGHT button again switches to TIMER ON setting. Press UP/DOWN button to adjust the ON time, ON time blinking. Pressing LEFT button goes back to time segment setting.
- Pressing RIGHT button switches to TIMER OFF setting. Pressing UP/DOWN button to adjust the OFF time, OFF time blinking. Pressing LEFT button goes back to TIMER ON setting.
- Pressing ENTER button confirms the TIMER ON/OFF setting at present time segment and goes back to time segment selection, the next SEG number blinking. Pressing UP/DOWN button continues selection of time segment. Repeat the above procedure for next setting.

Note: During group timer setting, pressing TIMER or BACK button can quit from the setting.

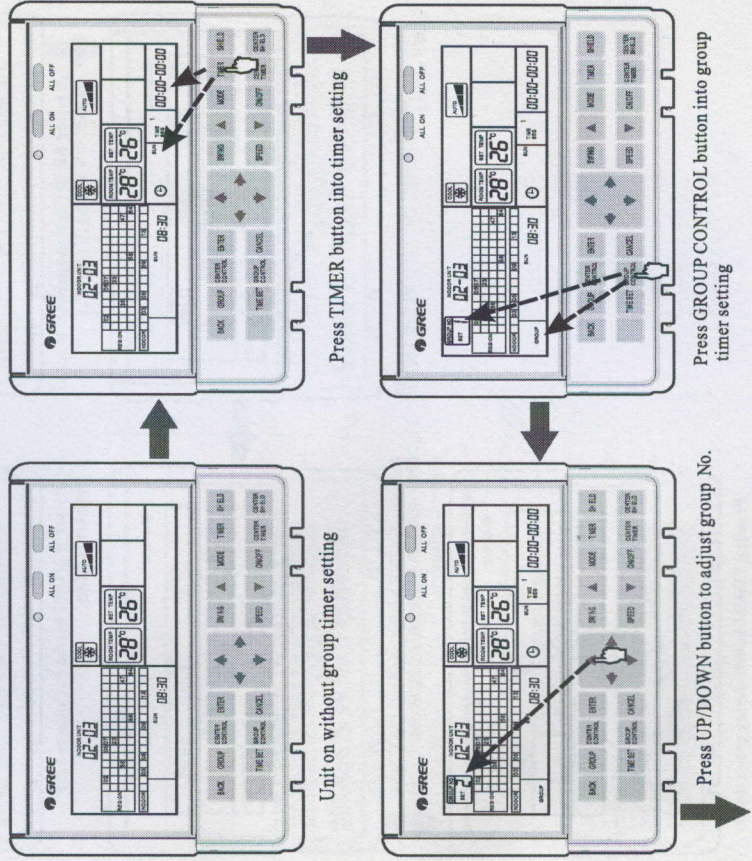

5.10 Checking Function

When the unit is ON, press UP/DOWN button to select the indoor unit to be queried, LCD displaying the corresponding parameters of "Region No.", "Indoor Unit No.", operation mode, set temperature, shield and timer etc.

In check status, the numbers of the online regions are normally on. For the first energization, min. online region No. and min.indoor unit No. is displayed; meanwhile, operation states of indoor unit including mode, room temperature, set temperature, fan speed, shield, swing and weekly timer are displayed. If the selected indoor unit has malfunction, error code will be displayed.

VI Installation and Debugging

Installation of centralized controller includes installation of itself and connection with communication modules.

6.1 Installation

After selection of installation location, perform the installation as follow:

- a. Confirm installation hole site:
To be installed in the wall
- 1) Drill a hole of 180mm×106mm×72mm (L×W×D)

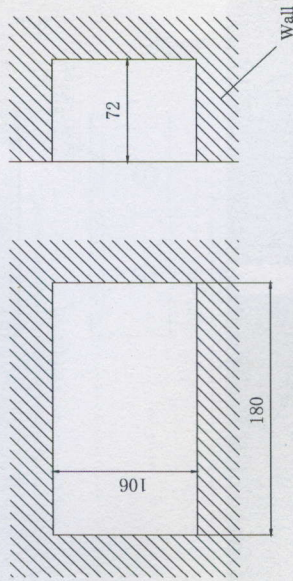

Fig. 17

- 2) Make 4 pieces of wooden or plastic wedges and then secure them , as shown in Figure 18 .

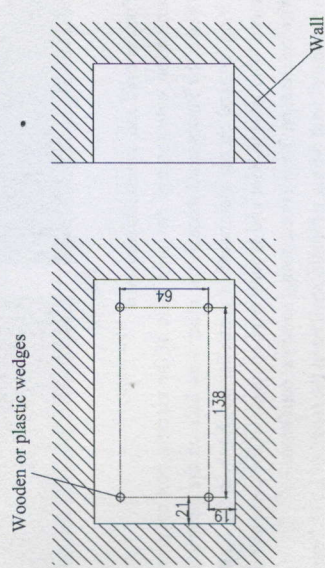

Fig. 18

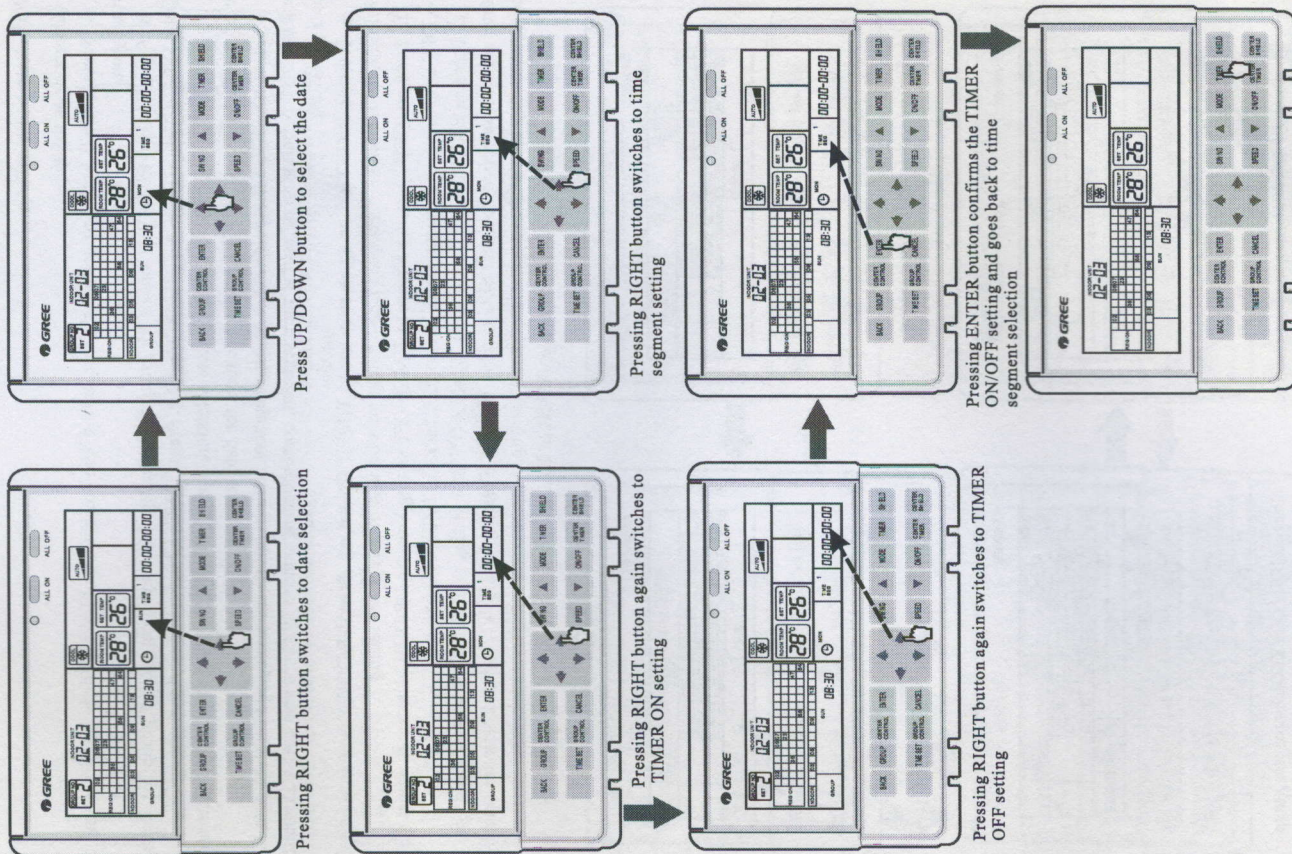

Fig. 16

To be installed in the control cabinet:
 Make 4 holes inside the wall of control cabinet according to the following dimension in the figure.

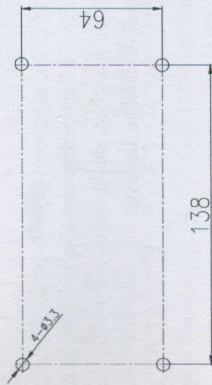

Fig. 19

b. Install the electric box cover on the wall or in the control cabinet and secure it through ST4.2X16 PA screws.

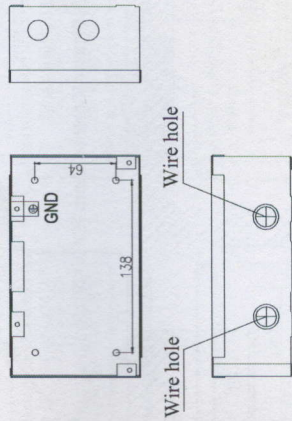

Fig. 20



Fig. 21

c. Connection of power cord and communication wire
 Make the communication wire through the wire hole of the electric box cover and insert it into the communication port. Make the Power cord through the other wire hole on the electric box cover should be connected with the wiring terminal on the mainboard of controller, as shown in the figure below. L connects with live wire, N connects with neutral wire and ground wire connects to the corresponding position marked on the electric box. Wire hole can be freely set according to actual condition.

Power cord width connected with wiring terminals shall be in the range of 1.5-2.2mm.
 Rated voltage of wiring terminal is 220-240 VAC.

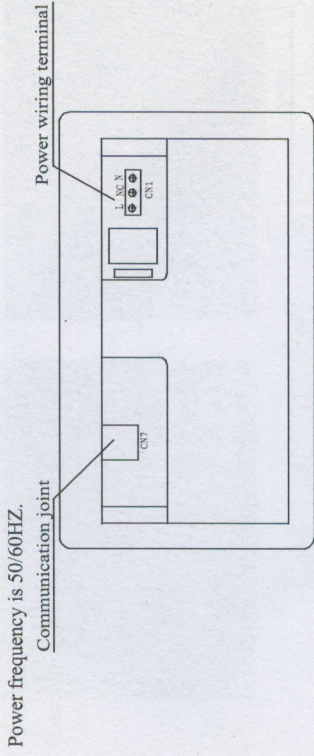

Fig. 22

d. Divide the centralized controller into two parts from the buckle as shown in the following figure-----
 upper cabinet and lower cabinet

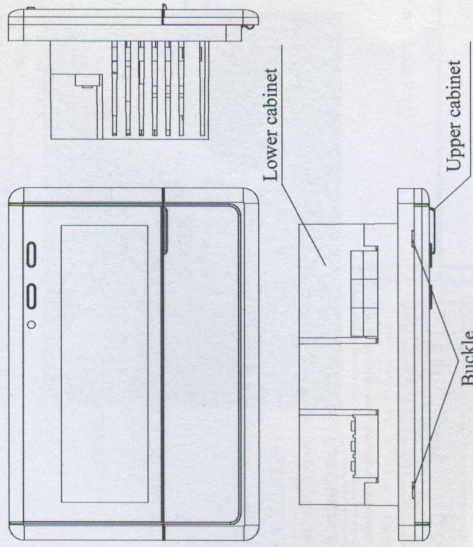

Fig. 23

e. Connect the electric box cover and lower cabinet with ST4.2X9.5 TC screws (Phillips brazier-head anti-slip screws), as shown in Fig.24, Fig. 25.

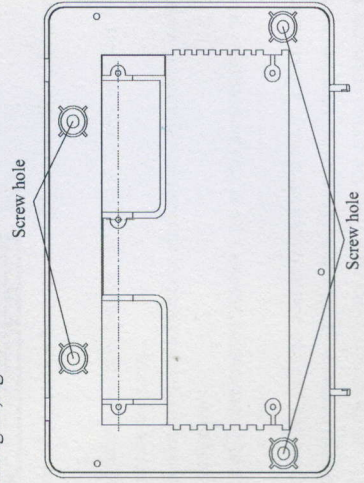

Fig. 24

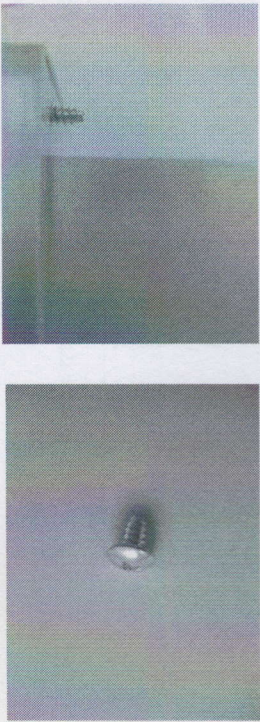

Fig. 25

f. Re-assemble the upper cabinet and debugging can begin after this.

Note: there are different screws (as shown in Fig. 26) available for the installation, so please distinguish and select them properly.

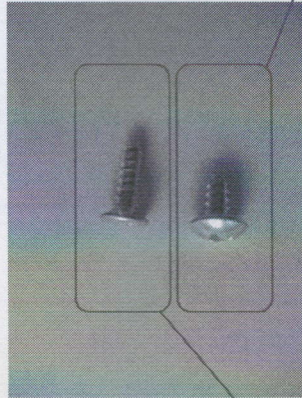

Fig. 26

6.2 Connection between centralized controller and communication module

Connection of them is shown in figure27.

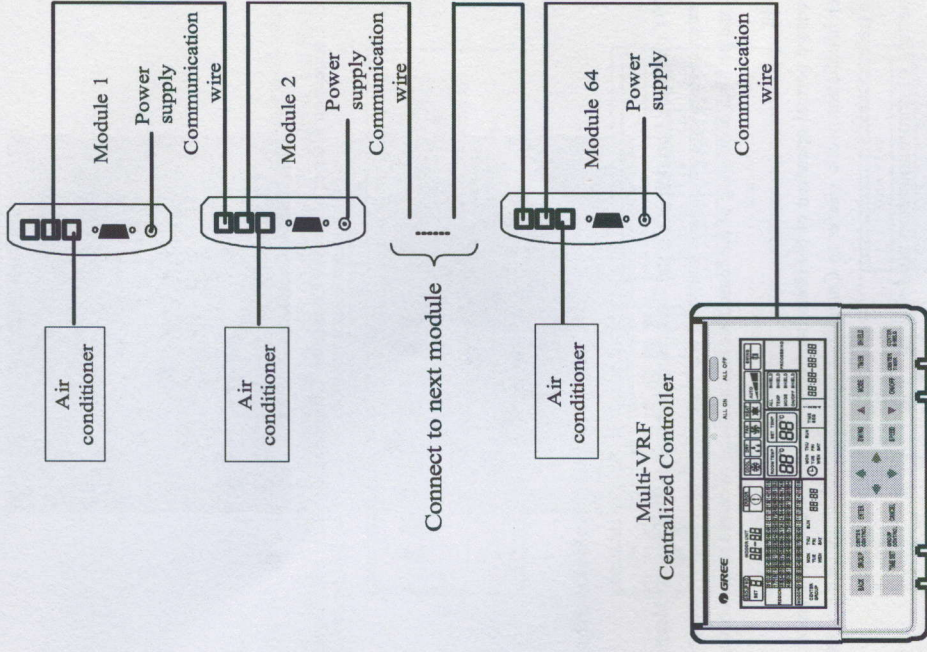

Fig.27 Skeeth map of connection between centralized controller and communication module

Note:

- a. Communication module's address can be set from 1 to 64. In order to avoid communication malfunction, addresses can not be the same.
- b. The communication wire of communication modules or centralized controller shall be equipped according to the distance in the project.
- c. Gree provides a piece of 2-core communication wire of 1m (the user shall extend the wire according to actual condition).
- d. The centralized controller and the communication module are connected together through a communication line with a crystal connector at both ends. Close to the controller, a magnetic ring is needed on the communication line and is approximately 10cm away from the crystal connector after wrapped two circles by the communication line. During the installation, the magnetic ring should be put inside the electric control

box after the crystal connector is connected with the smart zone controller. See the following figure for the connection manner and location.

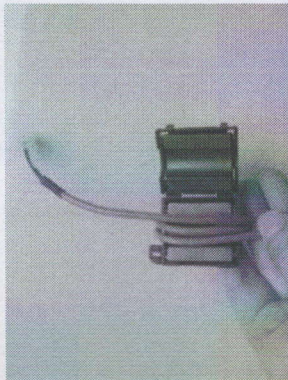

Fig.28 Connection Manner of Crystal Connector, Communication Line and Magnetic Ring



Fig.29 Connection Location of Crystal Connector, Communication Line and Magnetic Ring
 After completion of installing centralized controller and matched communication modules, the technician shall set address and perform debugging of the communication modules to ensure normal communication.

6.3 Debugging

In order to ensure normal operation of the centralized controller, the address of communication module shall be set after installation work. (Refer to Communication Module Instruction for details.) Fill in the Installation Table (refer to table 3)

6.3.1 Address setting of communication module

Set the address of communication module by the DIP switch. (Before operating DIP switch, cut off the power supply of communication module.)
 The DIP switch for communication module:



Fig.30 DIP switch

a. DIP2 setting

Dial all the rods to ON (means 0), as shown in Fig.31.

Code list from 1 to 7	1	2	3	Value
DIP2	ON	ON	ON	0
	ON	ON	0	0
	ON	0	0	1
	0	ON	0	2
	0	0	ON	3
	ON	0	1	4
	0	1	0	5
	1	1	0	6
	1	1	1	7

Fig.31 DIP2 setting

b. DIP1 setting

The 8-bit DIP switch in the communication module is for Modbus equipment address setting. It is integrated by SA2 and SA3 on PCB, but marked by DIP1. Dialing to ON means 0, and dialing to number end means 1. The address setting range is 1-64 (communication module address).

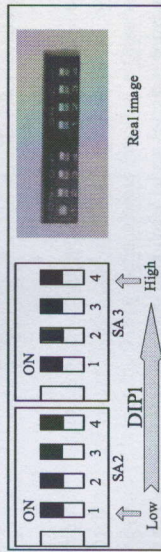

Fig. 32 DIP1 setting

1) Graphic example for setting of address 11

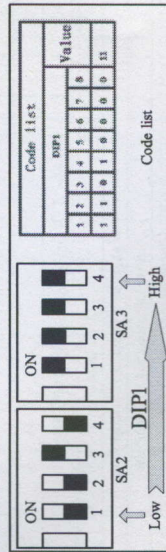

Fig. 33 Address 11

2) Graphic example for setting of address 43

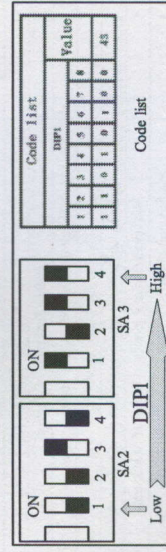

Fig. 34 Address 43

6.3.2 Debugging

After address setting of communication module, check if the setting is correct through the region No. on the centralized controller. For example, the address is set to "01", the centralized shall display region No. "01". If the region No. "01" is not displayed, it proves that the setting is incorrect. You should reset the address No. according to the Communication Module Instruction and DIP table.

After normal communication between centralized controller and communication module, an Installation Table shall be filled for check of information about each indoor unit. If the quantity of indoor units by check is inconsistent with that of the installed indoor units, address setting the communication module and connection

of the communication wire shall be checked again.

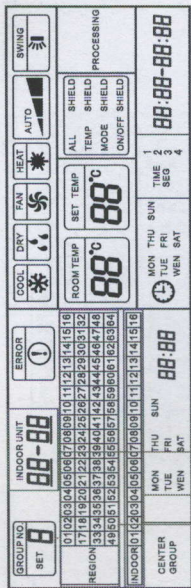

Fig. 35

Table 3 Installation Table

Region No.	Indoor unit No.	Present indoor unit No.	Indoor unit location
08	03	08-03	No.3 indoor unit in Room B Floor A

Note:

- ① . Region No. indicates online region No.1-64, displayed by the centralized controller.
- ② . Indoor unit No. indicates online indoor unit No., 1-16, displayed by centralized controller.
- ③ . Present indoor unit No. indicates present indoor unit No. displayed by centralized controller.
- ④ . Indoor unit location indicates actual location of centralized controller, which is expressed by No. indoor unit, Room ____, Floor ____.

VII Attachment

Error Code List:

Error Code	Malfunction
E1	High pressure protection of compressor
E2	Antifreezing protection of indoor unit
E3	Low pressure protection of compressor
E4	Discharge temperature protection of compressor
E5	Overcurrent protection, overload protection of compressor, drive malfunction
E6	Communication malfunction
E7	Modes conflict
E8	Indoor fan motor protection
E9	Water overflow protection (cassette type unit)
EH	E-heater protection
F0	Ambient temperature sensor malfunction of indoor unit
F1	Malfunction of coil pipe inlet sensor of indoor unit
F2	Malfunction of coil pipe intermediate sensor of indoor unit
F3	Malfunction of coil pipe outlet sensor of indoor unit
F4	Ambient temperature sensor malfunction of outdoor unit
F5	Malfunction of coil pipe inlet sensor of outdoor unit
F6	Malfunction of coil pipe intermediate sensor of outdoor unit
F7	Malfunction of coil pipe outlet sensor of outdoor unit
F8	Malfunction of discharge temperature sensor 1 (fixed)
F9	Malfunction of discharge temperature sensor 2 (digital)
FA	Malfunction of oil temperature sensor 1 (fixed)
Fb	Malfunction of oil temperature sensor 2 (digital)
Fc	High pressure sensor malfunction
Fd	Low pressure sensor malfunction
H6	PG Motor Stalling Protection

DIP table of communication module :

Table II DIP table of communication module

DIP1								Address value								DIP1								Address value							
1	2	3	4	5	6	7	8	1	2	3	4	5	6	7	8	1	2	3	4	5	6	7	8	1	2	3	4	5	6	7	8
1	0	0	0	0	0	0	0	1	0	0	0	0	0	0	0	1	0	0	0	0	0	0	0	1	0	0	0	0	0	0	0
0	1	0	0	0	0	0	0	2	0	0	0	0	0	0	0	0	1	0	0	0	0	0	0	0	1	0	0	0	0	0	0
1	1	0	0	0	0	0	0	3	1	1	0	0	0	0	0	1	1	0	0	0	0	0	0	1	1	0	0	0	0	0	0
0	0	1	0	0	0	0	0	4	0	0	0	0	0	0	0	0	0	0	0	0	0	0	0	0	0	0	0	0	0	0	0
1	0	1	0	0	0	0	0	5	1	0	0	0	0	0	0	1	0	0	0	0	0	0	0	1	0	0	0	0	0	0	0
0	1	1	0	0	0	0	0	6	0	1	0	0	0	0	0	0	1	0	0	0	0	0	0	0	1	0	0	0	0	0	0
1	1	1	0	0	0	0	0	7	1	1	0	0	0	0	0	1	1	0	0	0	0	0	0	1	1	0	0	0	0	0	0
0	0	0	1	0	0	0	0	8	0	0	0	0	0	0	0	0	0	0	0	0	0	0	0	0	0	0	0	0	0	0	0
1	0	0	1	0	0	0	0	9	1	0	0	0	0	0	0	1	0	0	0	0	0	0	0	1	0	0	0	0	0	0	0
0	1	0	1	0	0	0	0	10	0	1	0	0	0	0	0	0	1	0	0	0	0	0	0	0	1	0	0	0	0	0	0
1	1	0	1	0	0	0	0	11	1	1	0	0	0	0	0	1	1	0	0	0	0	0	0	1	1	0	0	0	0	0	0
0	0	1	1	0	0	0	0	12	0	0	0	0	0	0	0	0	0	0	0	0	0	0	0	0	0	0	0	0	0	0	0
1	0	1	1	0	0	0	0	13	1	0	0	0	0	0	0	1	0	0	0	0	0	0	0	1	0	0	0	0	0	0	0
0	1	1	1	0	0	0	0	14	0	1	0	0	0	0	0	0	1	0	0	0	0	0	0	0	1	0	0	0	0	0	0
1	1	1	1	0	0	0	0	15	1	1	1	0	0	0	0	1	1	1	0	0	0	0	0	1	1	1	0	0	0	0	0
0	0	0	0	1	0	0	0	16	0	0	0	0	0	0	0	0	0	0	0	0	0	0	0	0	0	0	0	0	0	0	0
1	0	0	0	1	0	0	0	17	1	0	0	0	0	0	0	1	0	0	0	0	0	0	0	1	0	0	0	0	0	0	0
0	1	0	0	1	0	0	0	18	0	1	0	0	0	0	0	0	1	0	0	0	0	0	0	0	1	0	0	0	0	0	0
1	1	0	0	1	0	0	0	19	1	1	0	0	0	0	0	1	1	0	0	0	0	0	0	1	1	0	0	0	0	0	0
0	0	1	0	1	0	0	0	20	0	0	0	0	0	0	0	0	0	0	0	0	0	0	0	0	0	0	0	0	0	0	0
1	0	1	0	1	0	0	0	21	1	0	0	0	0	0	0	1	0	0	0	0	0	0	0	1	0	0	0	0	0	0	0
0	1	1	0	1	0	0	0	22	0	1	0	0	0	0	0	0	1	0	0	0	0	0	0	0	1	0	0	0	0	0	0
1	1	1	0	1	0	0	0	23	1	1	0	0	0	0	0	1	1	0	0	0	0	0	0	1	1	0	0	0	0	0	0
0	0	0	1	1	0	0	0	24	0	0	0	0	0	0	0	0	0	0	0	0	0	0	0	0	0	0	0	0	0	0	0
1	0	0	1	1	0	0	0	25	1	0	0	0	0	0	0	1	0	0	0	0	0	0	0	1	0	0	0	0	0	0	0
0	1	0	1	1	0	0	0	26	0	1	0	0	0	0	0	0	1	0	0	0	0	0	0	0	1	0	0	0	0	0	0
1	1	0	1	1	0	0	0	27	1	1	0	0	0	0	0	1	1	0	0	0	0	0	0	1	1	0	0	0	0	0	0
0	0	1	1	1	0	0	0	28	0	0	0	0	0	0	0	0	0	0	0	0	0	0	0	0	0	0	0	0	0	0	0
1	0	1	1	1	0	0	0	29	1	0	0	0	0	0	0	1	0	0	0	0	0	0	0	1	0	0	0	0	0	0	0
0	1	1	1	1	0	0	0	30	0	1	0	0	0	0	0	0	1	0	0	0	0	0	0	0	1	0	0	0	0	0	0
1	1	1	1	1	0	0	0	31	1	1	1	0	0	0	0	1	1	1	0	0	0	0	0	1	1	1	0	0	0	0	0
0	0	0	0	0	1	0	0	32	0	0	0	0	0	0	0	0	0	0	0	0	0	0	0	0	0	0	0	0	0	0	0

Multi-VRF Centralized Controller

Installation table:

Table III

Region No. (Address module No.)	Indoor unit No.	Present indoor unit No.	Indoor unit location

Note: This table shall be filled by technician for maintenance.

Gree Electric Appliances, Inc. of Zhuhai
Jin Ji West Road, Qianshan, Zhuhai, Guangdong 519070 P.R. China
<http://www.gree.com>

GREE 6617431