



# **Owner's Manual**

## **Original Instructions**

Commercial Air Conditioners

## Multi-VRF Centralized Controller

Model:

CE52-24/F(C)

Thank you for choosing commercial air conditioners. Please read this Owner's Manual carefully before operation and retain it for future reference.

If you have lost the Owner's Manual, please contact the local agent or visit [www.gree.com](http://www.gree.com) or send an email to [global@gree.com.cn](mailto:global@gree.com.cn) for the electronic version.

GREE ELECTRIC APPLIANCES, INC. OF ZHUHAI

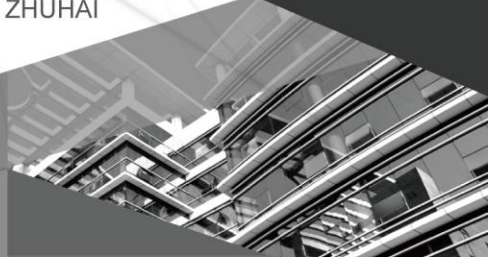

# To Users

Thank you for selecting Gree's product. Please read this instruction manual carefully before installing and using the product, so as to master and correctly use the product. In order to guide you to correctly install and use our product and achieve expected operating effect, we hereby instruct as below:

- (1) This appliance is not intended for use by persons (including children) with reduced physical, sensory or mental capabilities, or lack of experience and knowledge, unless they have been given supervision or instruction concerning use of the appliance by a person responsible for their safety. Children should be supervised to ensure that they do not play with the appliance.
- (2) This instruction manual is a universal manual, some functions are only applicable to particular product. All the illustrations and information in the instruction manual are only for reference, and control interface should be subject to actual operation.
- (3) In order to make the product better, we will continuously conduct improvement and innovation. We have the right to make necessary revision to the product from time to time due to the reason of sales or production, and reserve the right to revise the contents without further notice.
- (4) For personal injury or property loss and damage caused by improper operation such as improper installation and debugging, unnecessary maintenance, violation of related national laws and rules and industrial standard, and violation of this instruction manual, etc., we will bear no liability.
- (5) The final right to interpret for this instruction manual belongs to Gree Electric Appliances Inc. of Zhuhai.

# Contents

1 Safety Notices (Please be sure to abide ) .....	1
2 User Notice .....	1
3 INSTALLATION.....	2
3.1 Installation Requirements .....	3
3.2 Wiring Instructions .....	4
3.3 Installation Procedure.....	8
3.4 Removal Procedure.....	9
4 DISPLAY AND WORKING INSTRUCTIONS .....	10
4.1 Main Page Display and Buttons .....	10
4.2 General Buttons .....	11
4.3 Buttons Working Instructions .....	12
5 FUNCTIONS DESCRIPTION.....	13
5.1 Help Info .....	13
5.2 Indoor Unit.....	13
5.3 Single Unit Control.....	15
5.4 All-Control Function .....	17
5.5 Group Control.....	19
5.6 Schedule Management .....	20
5.7 Local Setting.....	22
5.8 Engineering Setting .....	24
5.9 About.....	25

# 1 Safety Notices (Please be sure to abide )



Warning: If not abide strictly, it may cause severe damage to the unit or the people.



Note: If not abide strictly, it may cause slight or medium damage to the unit or the people.



This sign indicates that the operation must be prohibited. Improper operation may cause severe damage or death to people.



This sign indicates that the items must be observed. Improper operation may cause damage to people or property.



**WARNING!**

This product can't be installed at corrosive , inflammable or explosive environment or the place with special requirements, such as kitchen. Otherwise, it will affect the normal operation or shorten the service life of the unit, or even cause fire hazard or serious injury. As for above special places, please adopt special air conditioner with anti-corrosive or anti-explosion function .

## 2 User Notice

- ◆ All indoor units must be supplied with unified power.
- ◆ Make sure communication cord is connected with the proper port, otherwise there may occur communication malfunction.
- ◆ Never knock on, throw or frequently detach the centralized controller.
- ◆ Never operate the centralized controller with wet hands.
- ◆ Never scratch the screen of centralized controller by hard or sharp objects.
- ◆ If the centralized controller is connected with the outdoor network or the last indoor unit of the indoor network, then a matching resistance must be connected between G1 and G2 ports.

### 3 INSTALLATION

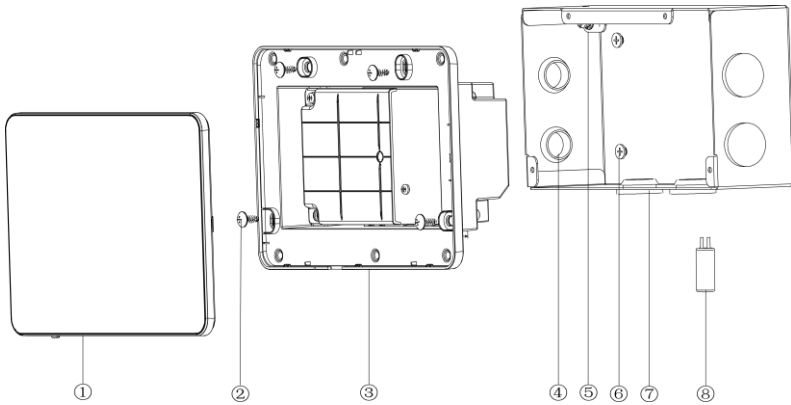

Fig.3.1 Parts of Centralized Controller

No.	①	②	③	④
Name	Touch screen	Self-tapping screw ST4.2×9.5 MC (used to secure the rear cover of controller)	Rear cover of controller	Rubber band
QTY	1	4	1	6

No.	⑤	⑥	⑦	⑧
Name	Screw M4×12 (used to secure earthing wire)	Screw ST4.2×16 FA (used to secure electric box cover)	Electric box cover	Matching resistance
QTY	1	4	1	1

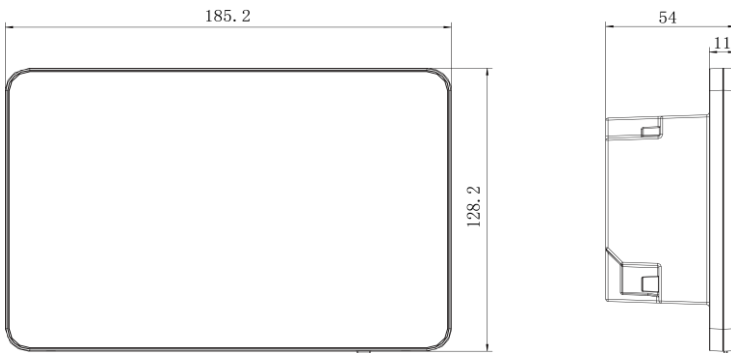

Fig.3.2 Dimension of Centralized Controller

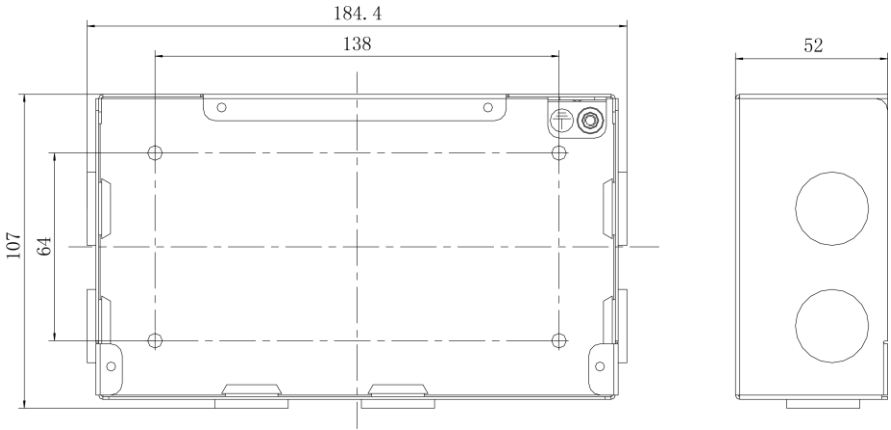

Fig.3.3 Dimension of Electric Box Cover

### 3.1 Installation Requirements

(1) Communication cord of the centralized controller must be selected according to the table below. Never use the cable that is not in compliance with instructions of this manual.

Network	Cord type	Cord standard	Cord size (mm <sup>2</sup> /AWG)	Total length L(m/feet)	Remark
Indoor network	Light/Ordinary polyvinyl chloride sheathed cord. (60227 IEC 52 /60227 IEC 53)	IEC 60227-5:2007	2x0.75~2x1.25  (2xAWG18~2xAWG16)	L≤1000m (L≤3280-5/6feet)	If cord size is 2x1mm <sup>2</sup> (2xAWG16), communication cord can be stretched longer. But the total length can't exceed 1500m(4921-1/4feet).
Outdoor network				L≤250 (L≤820-1/5feet)	Total length of communication cord can't exceed 250m(820-1/5feet).

 Notice:

- ① The cord shall be Circular cord (the cores shall be twisted together).
- ② If unit is installed in places with intense magnetic field or strong interference, it is necessary to use shielded wire.

(2) Never install the centralized controller in the following places:

- 1) Places with corrosive gas or serious dust, salt mist or oil smoke.
- 2) Wet and damp places, with direct sunlight.
- 3) Places near high temperature objects or places where units might be

splashed by water.

## 3.2 Wiring Instructions

### (1) Wiring Ports

Port print	G1, G2	F1, F2	A2, B2	A3, B3	L, N
Meaning	CAN comm. port	【reserved port】	【reserved port】	【reserved port】	Power port

### (2) Power Supply

The centralized controller shall use independent power supply.

The range of input voltage: 100~240 VAC; Frequency range: 50/60Hz

Select power cord according to the following table. Never use the power cord that is not in compliance with instructions of this manual.

Cord type	Cord standard	Cord size (mm <sup>2</sup> )
Single-cord soft conductiveunsheathed cord (60227 IEC 08)	IEC 60227-3:2007	1.5

### (3) Connection Method

There are three methods to connect centralized controller with the air conditioning system.

#### Method 1: Connect with indoor network

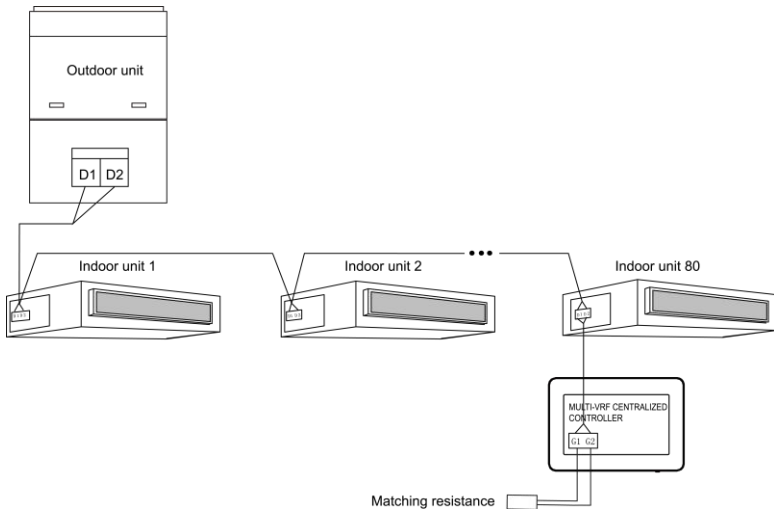

Fig.3.4 Centralized Controller Connected with Indoor Network

Method 2: Connect with outdoor network

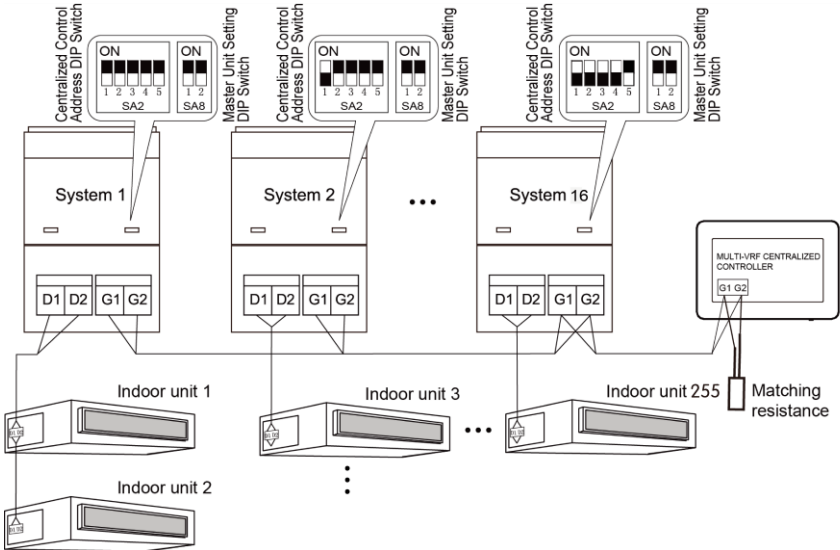

Fig.3.5 Centralized Controller Connected with Outdoor Network

Method 3: Connect with heat recollection mode converter Network

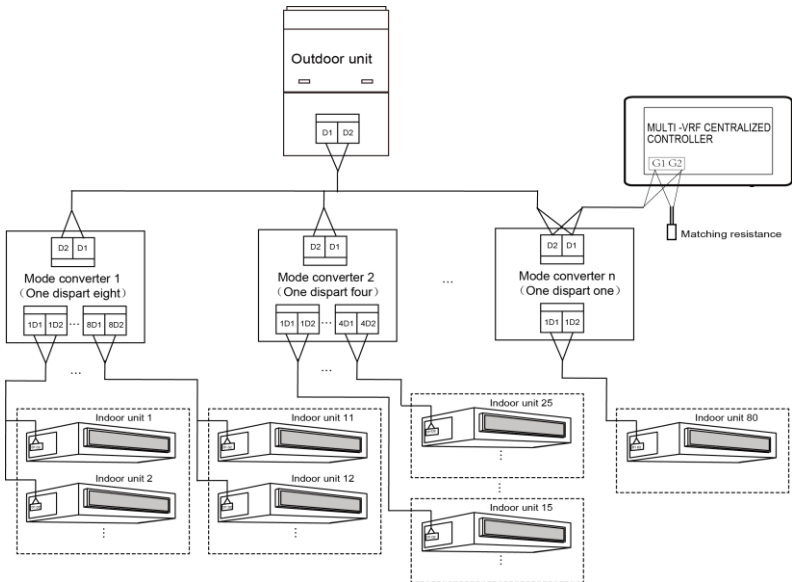

Fig. 3.6 Centralized Controller Connected with Heat Recollection Mode Converter Network



**Wiring Instructions:**

a. The centralized controller is applicable to multi VRF units, connectable with network of indoor units or the network of outdoor units. One centralized controller can control up to 16 sets of outdoor system and up to 255 sets of indoor unit.

b. If the centralized controller is to be connected with the network of indoor units, connect according to fig.3.4. The controller can connect with any one indoor unit in series, that is, connect the controller's G1 and G2 ports with the D1 and D2 ports correspondingly with communication cords. When the controller is connected with the terminal unit of indoor network, a matching resistance needs to be added with the communication cords at the G1 and G2 ports.

c. If the centralized controller is to be connected with the network of outdoor units, connect according to fig.3.5. The centralized controller can only be connected with the terminal system of the outdoor network. A matching resistance needs to be added with the communication cords at the G1 and G2 ports.

d. The centralized control address DIP switch (SA2\_Addr-CC) indicates the centralized control address required when different refrigerating systems are controlled in a centralized manner. The default factory setting is "00000".

e. If the centralized controller is to be connected with the network of heat recollection, connect according to Fig.3.6. The method 2 is also applicable to centralized controller switching in heat recollection network.

If the centralized controller is to be connected with the network of outdoor units, set the DIP switch according to the following methods:

- a) The DIP switch must be set on the master unit and set the Master Unit Setting DIP Switch(SA8) to "00".Otherwise, the setting is invalid.
- b) On the same refrigerating system, the centralized control address DIP switch (SA2\_Addr-CC) on a non-master unit is invalid, and it is unnecessary to change the settings.
- c) The centralized control address DIP switch (SA2\_Addr- CC) on the master unit of a refrigerating system must be set to "0000/" , and this system is the master system.
- d) The centralized control address DIP switch (SA2\_Addr- CC) on the master unit of other refrigerating systems must be set as follows:

**Note:** The centralized control address switch of DIP5 invalidation

SA2					Address NO.
DIP1	DIP2	DIP3	DIP4	DIP5	
1	0	0	0	/	2
0	1	0	0	/	3
1	1	0	0	/	4
0	0	1	0	/	5
1	0	1	0	/	6
0	1	1	0	/	7
1	1	1	0	/	8
0	0	0	1	/	9
1	0	0	1	/	10
0	1	0	1	/	11
1	1	0	1	/	12
0	0	1	1	/	13
1	0	1	1	/	14
0	1	1	1	/	15
1	1	1	1	/	16

- e) The centralized control address DIP switch (SA2\_Addr- CC) cannot be the same between different refrigerating systems. Otherwise, address conflicts may occur and the unit cannot run properly.
- f) If the address conflict occurs, it will popup the address conflict page.

**Note:**There are three ways to solve address conflict.

- 1: Enter into an unoccupied address by manually for the conflict address, the address conflict can be solved after it set up success.
- 2: Press and hold the “Save” button for 5 seconds on the address conflict page, select reset all the IDU’s address in the system, after entering the engineering password, system will reassign all the address.
- 3: On the master unit of master system, press “SW3” to enter the to-be-selected status of function settings, press “SW1 (UP)” or “SW2 (DOWN)” to select the function of “n5”, press “SW7” to enter “n5” function settings, press “SW7” again to send the project number offset command.

### 3.3 Installation Procedure

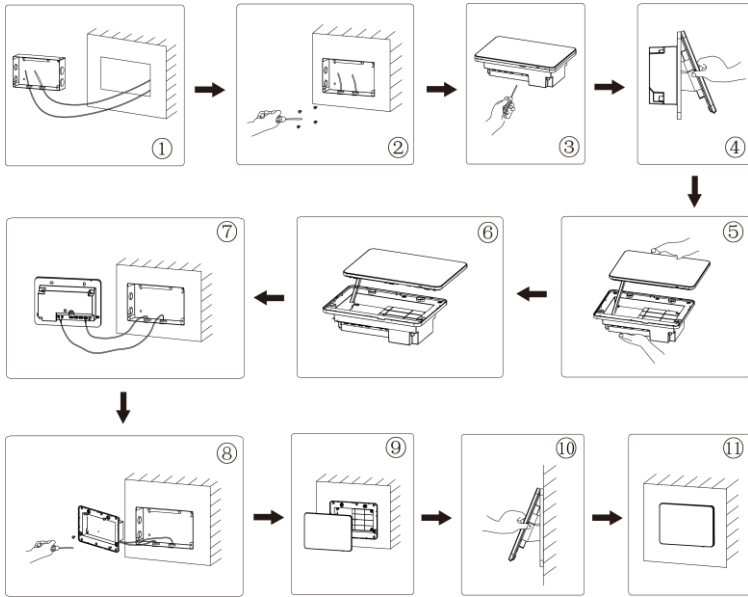

Fig.3.7 Installation Diagram

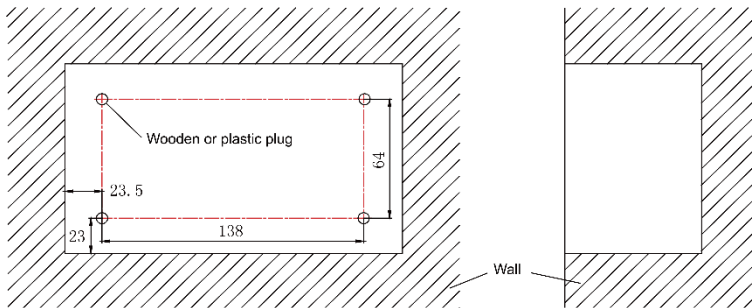

Fig.3.8 Diagram of Wooden or Plastic Plug

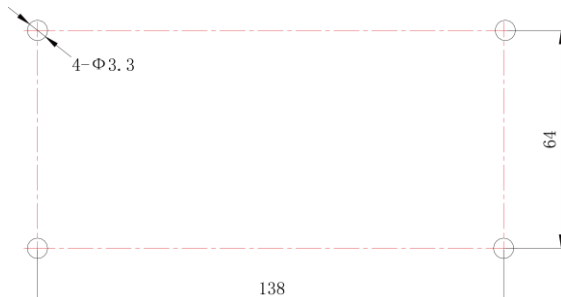

Fig. 3.9 Installation Holes of the Electric Box Rear Cover

Fig.3.7 is a simple installation procedure of centralized controller. Please pay attention to the following matters:

- (1) Before installation, first cut off the power supply of indoor unit. The power must be cut off during the whole installation process.
- (2) During the installation, be careful not to damage to touch screen.
- (3) Before installation, please make the following preparations:
  - 1) In case that the centralized controller is installed on wall, dig a hole that is the size of  $180\text{mm} \times 107\text{mm} \times 62\text{mm}$  and peg 4 wooden or plastic plugs on the wall according to fig.3.8.
  - 2) In case that the centralized controller is installed inside the control cabinet, dig 4 installation holes on the surface of the control cabinet according to fig.3.9.
- (4) In step ①, pull out the power core and communication cord, and then lead them separately from the wire orifice of the electric box rear cover. Never lead the cords through a same orifice.
- (5) In step ②, locate the electric box rear cover to the installation holes of the wall with screw  $\text{ST}4.2 \times 16 \text{ FA}$ .
- (6) In step ⑥ pull out the wire connecting the touch screen and controller's rear cover. Put the touch screen on a safe place.
- (7) In step ⑦, connect the communication cords to G1, G2 terminals, and connect the neutral wire and live wire to the N, L terminal; connect the ground wire to position  $\perp$  on the electric box rear cover. Secure it with screw  $\text{M}4 \times 12$ .
- (8) In step ⑧, locate the controller's rear cover onto the electric box rear cover with screw  $\text{ST}4.2 \times 9.5 \text{ TC}$ .
- (9) In step ⑨, connect the wire between touch screen and controller's rear cover.

### 3.4 Removal Procedure

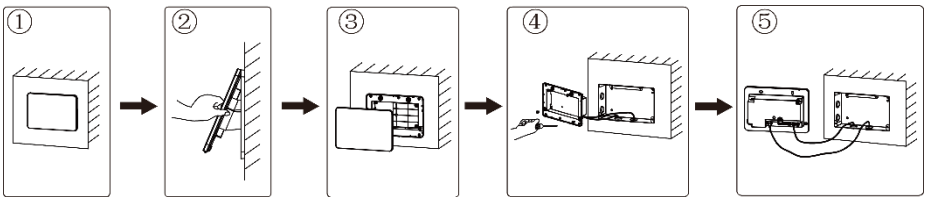

Fig.3.10 Diagram of Removal

## 4 DISPLAY AND WORKING INSTRUCTIONS

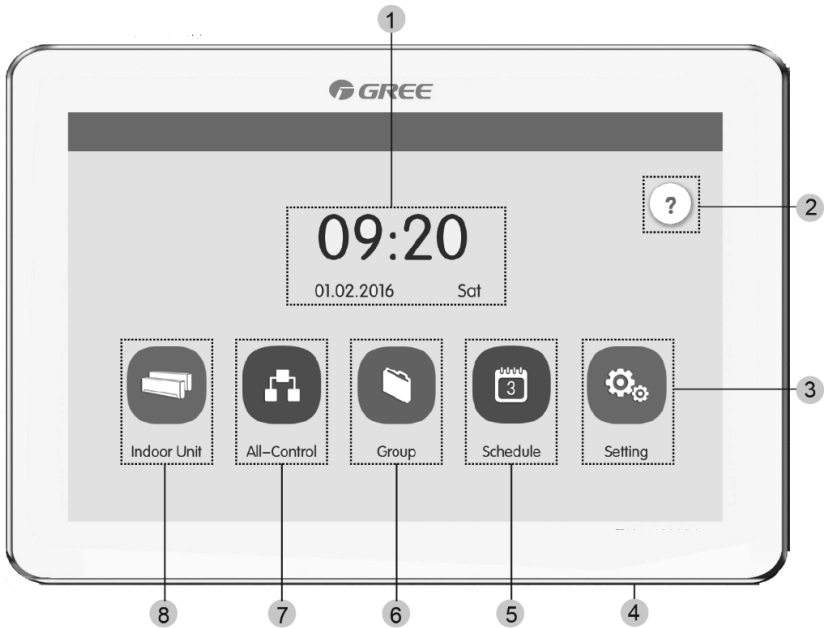

























Fig.4.1 Main Page

### 4.1 Main Page Display and Buttons

No.	Name	Instructions
1	Time zone	The present date, week and time
2	Help button 	Press this button to enter Help Info page
3	Setting button 	Press this button to enter setting page
4	Touch button	<ul style="list-style-type: none"> <li>● Press the Touch Button to turn on/off the screen of centralized controller.</li> <li>● Press and hold the Touch Button for 5sec to restart to centralized controller.</li> </ul>
5	Schedule button 	Press this button to enter schedule page
6	Group button 	Press this button to enter group page
7	All-Control button 	Press this button to enter All-Control page

8	Indoor Unit button 	Press this button to enter indoor unit page
---	--	---

## 4.2 General Buttons

Display	Name	Meaning	Display	Name	Meaning
	Return	Press this button to return to the previous page		Cancel	Press this button to cancel the current setting and return to the previous page
	Save	Press this button to save the current setting and return to the previous page		Add	Press this button to add schedule
	Group Control	Press this button to enter Group control page		IDU Sort	Press this button to enter IDU sort page
	Edit	Press this button to edit the group or schedule		Delete	Press this button to delete group or schedule
	Up	Press this button to increase value or select the previous option		Down	Press this button to decrease value or select the next option
	Left	Press this button to return back to previous page		Right	Press this button to the next page
	Forward Page Shift	On the IDU sort page, Press this button to move the selected IDU forward one page		Backward Page Shift	On the IDU sort page, Press this button to move the selected IDU backward one page
	Forward Shift	On the IDU sort page, Press this button to move the selected IDU forward one place		Backward Shift	On the IDU sort page, Press this button to move the selected IDU backward one place
	Info	Press this button to enter Info page		Shield	Press this button to conduct shield function of wired controller to nullify such operation

## 4.3 Buttons Working Instructions

The centralized controller uses a capacitive touch screen so that user can operate the units by just touching the screen.

Buttons on the screen are presented in the following ways:

(1) Icon

Icon button can be operated directly. See section 2.2 for more details.

(2) Icon + Text

According to the meaning of words, turn on or off or select a certain function, or enter a certain page. This type of button has 2 or 3 kinds of status based on the specific function.

Meaning of status (take Sleep Button as an example):



Thin light indicates invalid/not selectable. Sleep function is invalid and can't be selected. Different cases for models.



Light indicates off/not selected. Sleep function is off. Pressing the grey sleep button can turn on the sleep function.



Dark indicates on/selected. Sleep function is on. Pressing the orange sleep button can turn off the sleep function.

(3) Sliding

Sliding up/down to slide the group and setting page up&down.

(4) Sliding bar

Press and hold the sliding bar to drag up/down or left/right and to adjust the value. For example the backlight setting, etc.

(5) Zone button

On the management pages of schedule, as indicated in fig.2.2 (the home page of schedule), each rectangle frame constitutes a zone button.

Press the zone button, then the turning on/off of corresponding function or the corresponding page will pop in.

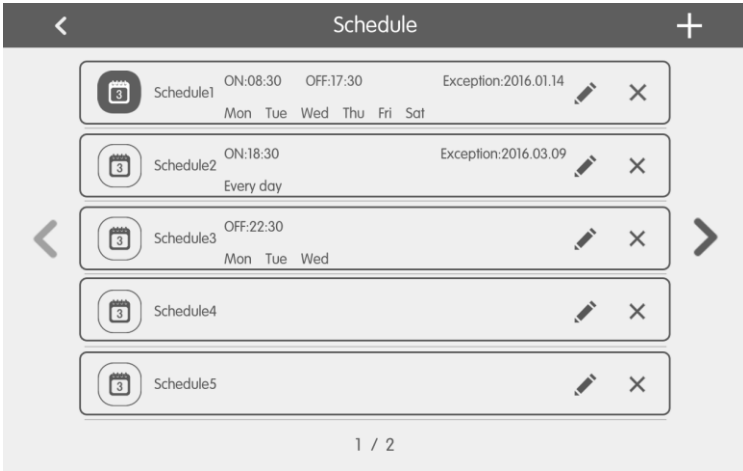

Fig.4.2 Zone Buttons on the Homepage of Schedule

## 5 FUNCTIONS DESCRIPTION

### 5.1 Help Info

On the homepage, press  to enter into help info page.

User can view the information of the simple operation manual.

### 5.2 Indoor Unit

On the homepage, press  to enter into indoor unit page.



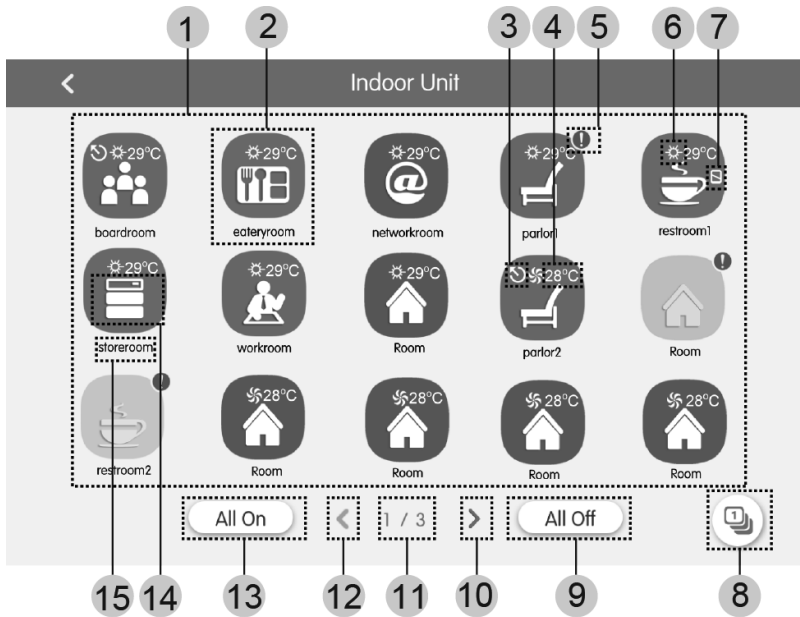



Fig.5.1 Page of Indoor Unit

No.	Name	Instructions
1	IDU display	Display in separate page the list of indoor units that are controlled by the centralized controller.
2	IDU icon	<ul style="list-style-type: none"> <li>● Press the button to enter the page of indoor unit control.</li> <li>● Light icon indicates that IDU is on while the dark icon indicated that IDU is off.</li> </ul>
3	Master IDU	This icon will be displayed when indoor unit is the master indoor unit of the system.
4	Set temperature	When indoor unit is on, set temperature will be displayed here.
5	Error status	Error icon will be displayed if indoor unit is malfunctioning.
6	Operation mode	When indoor unit is on, the current operation mode will be displayed: Auto     Cooling     Dry     Fan Heating     Floor heating     Space heating     3D heating
7	Shield status	This icon will be displayed when indoor unit is in shield status.
8	IDU Sort	Press the button to enter into the idu sort page.
9	All Off button	Press this button to turn off all air conditioning equipment.
10	Right page button	Press this button to show the next page idu list.

No.	Name	Instructions
11	Current page	The total pages of the controlled indoor unit and the current page.
12	Left page button	Press this button to show the previous page idu list.
13	All On button	Press this button to turn on all air conditioning equipment.
14	IDU icon	Display the icon of the indoor unit.
15	IDU name	Display the name of the indoor unit.

Press the  button to enter the IDU sort page.

Select one indoor unit , press the left or right button at the bottom of the screen to switch the display of the indoor units.

### 5.3 Single Unit Control

On the indoor unit control page or group page, press the icon of indoor unit to enter the single unit control.

Press the icon of indoor unit for 5 seconds to pop up the name set of the selected indoor unit.

Parameters of single unit control include parameters of general control and advanced control.

#### 5.3.1 General Control Parameters

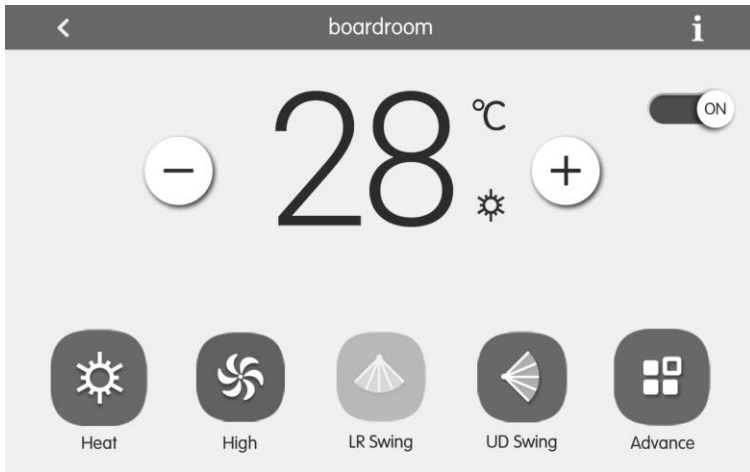

Fig.5.2 Control Page of Single IDU

### (1) ON/OFF

Press the on/off button to turn unit on or off.

When unit is turned off, mode, temperature, fan speed and swing can't be set.

### (2) Mode setting

Press the Mode buttons to set unit's operation mode.

Modes for indoor units of different series are not all the same.

If a certain mode is not available in the indoor unit, the icon of the corresponding mode cannot be selected.

#### **Note:**

- ① Auto mode can only be set in the master indoor unit.
- ② Heat recollection system have no master indoor unit. When the indoor unit of the same branch is connected into one indoor unit, the auto mode can be set; when the quantity of indoor unit in the same branch is more than one set, the auto mode cannot be set; other modes can be freely switched.

### (3) Temperature setting

Press the up or down buttons to adjust temperature. Each time pressing the button will increase/decrease the temperature by 1. Holding down the button can increase/decrease temperature continuously.

Pressing the  button can display the "indoor temp" and "outdoor temp".

### (4) Fan speed setting

Press the fan speed button to set unit's fan speed.

Note: Unit defaults to low fan speed in drying mode. Fan speed cannot be set in drying or floor heating mode.

### (5) Swing setting

Pressing the button "Up&Down Swing" or "Left&Right Swing" can turn on or off the swing function.

Note: Swing types for indoor units of different series are not all the same.

### (6) Malfunction View

When indoor unit fails to function well, the  will turn red. then press the button to view the information of malfunctions.

### 5.3.2 Advanced Control Parameters

Press Advance Button to enter the advance page.

Press icon buttons to turn on or off the corresponding function.

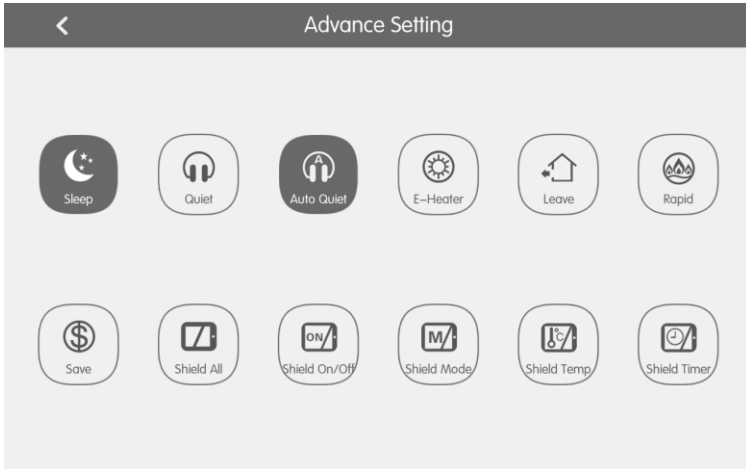

Fig.5.3 Advance Page

- (1) Functions of Sleep, Quiet, Auto Quiet, E-Heater, Absence, Rapid and Save can only be effective when unit is turned on.
- (2) When sleep function is on, auto quiet function will be turned on subsequently. Sleep function will not be effective under auto, fan or floor heating mode.
- (3) Absence function can only be turned on in heating mode. When absence function is on, set temperature is 8°C.
- (4) Rapid cool function can only be effective in cool mode. Likewise, rapid heat function can only be effective in heat mode.
- (5) When shield all function is on, other shield buttons will be invalid.
- (6) Note: When centralized controller is matching with different units, some functions will also be different for different unit.

### 5.4 All-Control Function

On the homepage, press  to enter into the page of All-Control.



Fig.5.4 All-Control Page

All-Control Function can operate all indoor units as below:

(1) ON/OFF

Press ON/OFF button to turn on or turn off all units.

When turning off the unit, the setting for mode, temperature, fan speed and swing is unavailable.

(2) Mode setting

Press mode button to set operation mode.

(3) Temperature setting

Press UP or Down button to adjust temperature. Press this button once to increase or decrease temperature 1°C. Press or hold this button and the temperature will increase or decrease continuously.

(4) Fan speed setting

Press or drag the sliding bar of fan speed to set fan speed.

Note: Fan speed defaults at low speed under drying mode and it can't be adjusted.

(5) Swing setting

Press "left&right" swing or "up&down" swing button to turn on or turn off swing function.

(6) Send order

Press button  to send out the All-Control order.

## 5.5 Group Control





On the homepage, press  to enter into the page of group function.



Fig.5.5 Group Page

No.	Name	Instructions
①	Group display	Display in separate page the list of groups that are controlled by the centralized controller. Sliding up or down can turn over the page.
②	Group names	Display the names of every group.
③	Add group button	Press the button to add a group.
④	Group control button 	Press the button to enter the group control page.
⑤	Group edit button 	Press the button to enter the group edit page.
⑥	IDU sort button 	Press the button to enter the group sort page.

### (1) Group control

Press the  button to enter the page of group control. Control parameters are the same as single unit control.

Press button  to send out the group control order.

### (2) Edit group

Press  to enter the page of group editing.

User can set the group name and add indoor units to the group.

Press  to save the setting.

**Note:** 1 set of indoor unit can be set in up to 5 groups

(3) IDU sort

Press the  button to enter the IDU sort page.

Select one indoor unit, press the left of right button at the bottom of the screen to switch the display of the indoor units.

(4) Add group

Press the “ADD ” button to add new groups. Then the page of group editing will pop in. User can set the group name and add indoor units to the group.

(5) Delete group

Press  to delete the selected group.

## 5.6 Schedule Management

On the homepage, press  button to enter into the page of schedule management.

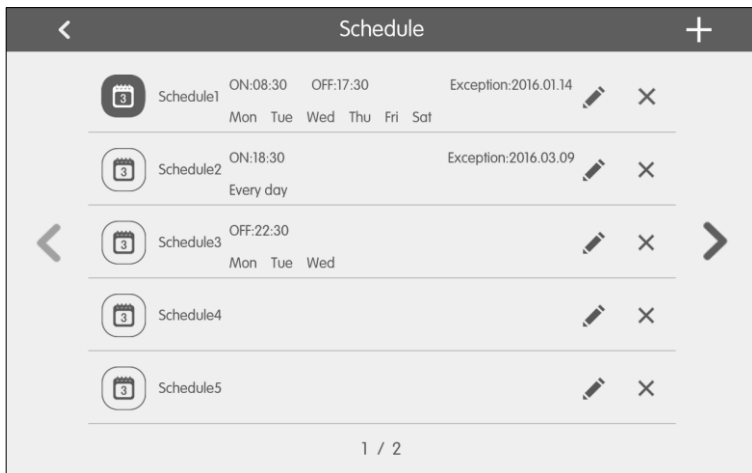

Fig.5.6 Page of Schedule

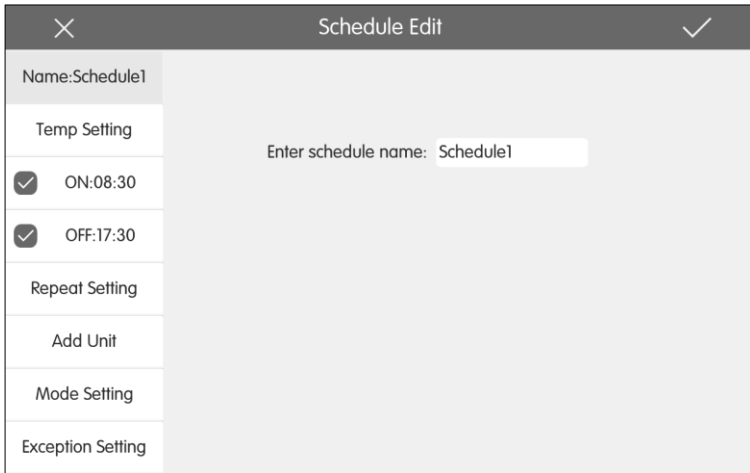

Fig.5.7 Page of Schedule Editing

(1) Open the schedule

Press the zone button to open or close the schedule.

When the icons and texts turn blue indicating the schedule is open.

When the icons and texts turn grey indicating the schedule is closed.

When schedule is open, centralized controller will send out the control order automatically according to the time and parameters set by the schedule.

(2) Edit schedule

Press  to enter the page of schedule editing.

Press  to save the schedule setting.

1) Setting method of schedule control parameters is the same with that of the single indoor unit control.

2) Add equipment

Press the “Add Unit” button to enter the page of equipment selection. User may set the indoor unit that works according to the current schedule.

Note: For a same indoor unit, different schedules can be set at the same time. In this case, unit will work according to the schedule setting that is previously energized.

3) Repeat schedule

Press “Repeat Setting” button to enter the setting page. User can set the schedule work repeatedly according to weeks.



#### 4) Time setting

Press the “ON Time” or “OFF Time” button to enter the page of time setting.

User can set the time for unit to turn on/off automatically.

Note: The time to activate or stop unit can be set at the same time, but they must not be the same.

#### 5) Add exception

Press the “Exception Setting” button to enter the setting page of schedule exception.

The calendar will pop in, user can select the date to activate or cancel exception. Press  to save the selected date.

**Notes:** When schedule exception has been set, air conditioner will not execute the control order on the exception date set by the schedule.

User may add several exception dates.

#### (3) Add schedule

Press  to add new schedules. Then the schedule editing page will pop in for user to set relevant parameters.

Note: User may add up to 28 schedules.

#### (4) Delete schedule

Press  to delete the selected schedule.

## 5.7 Local Setting

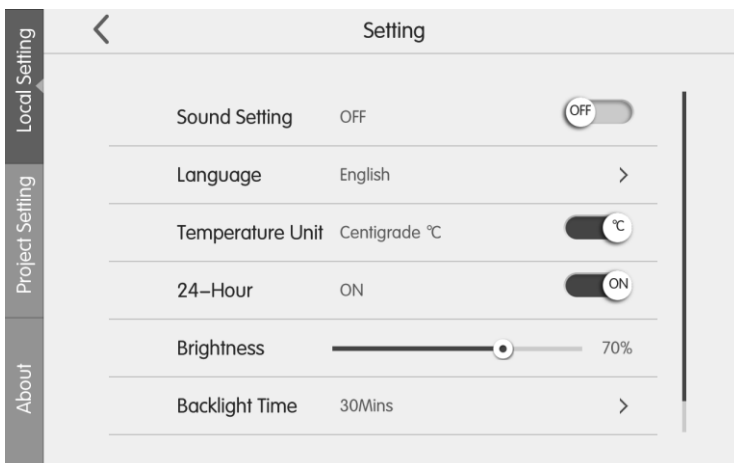



Fig.5.8 Setting Page

On the homepage,press  button to enter into the setting page.

Press the “Local Setting” button to switch to the setting options of the current unit.

Select the needed option at the left side column. Sliding up and down can turn over the page.

Set the corresponding content at the right side.

Local setting includes:

(1) Sound, temperature unit, time format, mutual exclusion

Press the button to select one kind of setting.

(2) Language

Press the button can select system language,such as English Simplified Chinese or Traditional Chinese.

(3) Time setting

Set the date and time of the centralized controller system, can also set the VRF unit time if needed.

(4) User password

Press the button can activate or inactivate user password.

When password is activated, it can be set or changed in 4~10 numbers or characters. Original password is blank.

Press the button  to save the password.

**Note:** If user password is activated, user needs to input password to enter the control page when centralized controller is turned on or activated.

(5) Backlight setting

Pressing this button can set the timeout period of screen backlight. Screen will be shut off and the centralized controller will enter sleep mode when the timeout period is over.

**Note:** When centralized controller is in sleep mode, use can wake it up by touching any part of the touch screen or the touch button at the right bottom of the screen.

(6) Brightness

Pressing or dragging the sliding bar can adjust the backlight degree.

(7) Customer Service

User can set the name and phone number of the local customer service center for the convenience of acquiring immediate solutions and technical support.

Press the  button to save the setting.

#### (8) Restore default settings

Press the “Reset” button to restore local setting, e-Control setting, group setting, schedule setting, names and icons of indoor units, and other relevant ex-factory default settings.

- 1) When switching between indoor network and outdoor network, or reset unit IP, restore the ex-factory setting for centralized controller.
- 2) After debugging for the centralized controller is finished, connect in to the network. If connect the centralized controller to the network during debugging process, it needs to restore the defaulted ex-factory setting.

## 5.8 Engineering Setting

On the home page, press  to enter into setting page.

Press the “Project Setting” button to switch to engineering setting, the operation method is the same as the setting of this unit.

#### (1) Indoor unit register

Enter into the indoor unit register interface, select the chosen indoor unit according to the displayed engineering No. of indoor unit icon, and then press  to save, it will display the registered indoor unit in the indoor unit page.

**Notes:** There are 255 sets of indoor units can be registered at most.

#### (2) Name&Icon setting

Switch to name&Icon setting interface to select the engineering No., and set the name and icon of indoor unit.

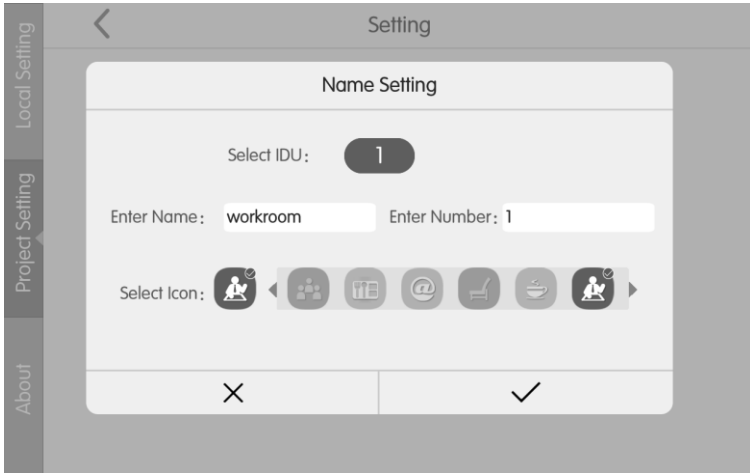



Fig. 5.9 Setting Page of Indoor Unit

Press the Engineering No. to select the required indoor unit that needs to be set.

1) Name: can input number or letter (it should not be over 10 letters)

2) Icon: press to select the preset icon.

3) Engineering No.: it can be set to be 1-255.

4) Press  button to successfully save the setting. Then the indoor unit list in the home page will display the new name and icon of indoor units.

### (3) Running Time

Enter into the Running Time management page. Selecting the ODU's system number or IDU's engineering No., then user can view the ODU or IDU continuous time and total time.

## 5.9 About

On the home page, press  to enter into setting page.

Press the "About" button to switch to about page. The operation method is the same with that of the local setting.

On the page of about, user can view the information of the local unit, customer service information and other notices.



GREE ELECTRIC APPLIANCES, INC. OF ZHUHAI

Add: West Jinji Rd, Qianshan, Zhuhai, Guangdong, China, 519070

Tel: (+86-756) 8522218

Fax: (+86-756) 8669426

E-mail: [gree@gree.com.cn](mailto:gree@gree.com.cn) [www.gree.com](http://www.gree.com)



6617000014