



Multi-VRF Centralized Controller

Owner's Manual

Commercial Air Conditioners

Model:

CE53-24/F(C)

- Thank you for choosing Air Conditioners, please read this owner's manual carefully before operation and retain it for future reference. If you have lost the Owner's Manual, please contact the local agent or visit www.gree.com or send email to global@gree.com.cn or electronic version.
- GREE reserves the right to interpret this manual which will be subject to any change due to product improvement without further notice.
- GREE Electric Appliances, Inc. of Zhuhai reserves the final right to interpret this manual.

User Notice

- ◆ All indoor units must be supplied with unified power.
- ◆ Make sure communication cord is connected with the proper port, otherwise there may occur communication malfunction.
- ◆ Never knock on, throw or frequently detach the centralized controller.
- ◆ Never operate the centralized controller with wet hands.
- ◆ Never scratch the screen of centralized controller by hard or sharp objects.
- ◆ If the centralized controller is connected with the outdoor network or the last indoor unit of the indoor network, then a matching resistance must be connected between G1 and G2 ports.
- ◆ All photos in this manual is only for reference, please refer to the actual product for the final effect.

Contents

| | | |
|----------|---|-----------|
| 1 | INSTALLATION | 1 |
| 1.1 | Installation Requirements | 2 |
| 1.2 | Wiring Instructions | 3 |
| 1.3 | Wiring Instructions | 6 |
| 1.4 | Removal Procedure | 8 |
| 2 | DISPLAY AND WORKING INSTRUCTIONS | 8 |
| 2.1 | Main Page Display and Buttons | 9 |
| 2.2 | General Buttons | 9 |
| 2.3 | Buttons Working Instructions | 10 |
| 3 | FUNCTIONS DESCRIPTION | 11 |
| 3.1 | All ON/OFF | 11 |
| 3.2 | Single Unit Control | 11 |
| 3.3 | Water /Floor control | 13 |
| 3.4 | e-Control Function | 18 |
| 3.5 | Group Control | 19 |
| 3.6 | Schedule Management | 20 |
| 3.7 | Local Setting | 22 |
| 3.8 | Engineering Setting | 24 |
| 3.9 | Operation Notice | 25 |

1 INSTALLATION

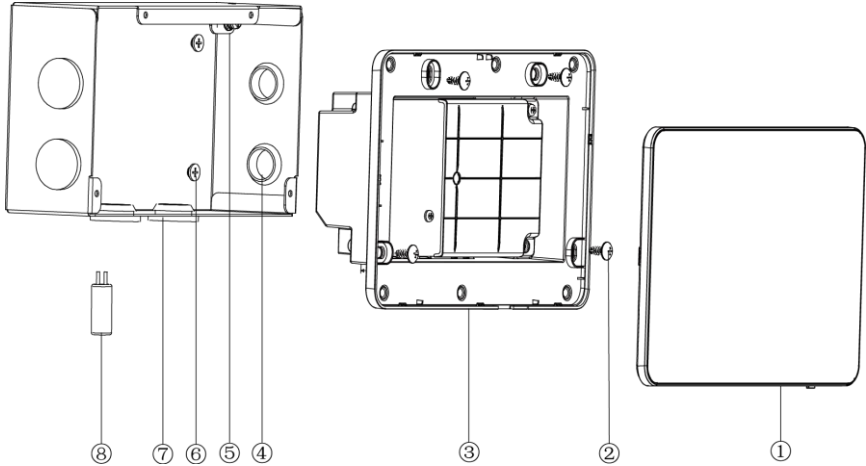

Fig.1.1 Parts of Centralized Controller

| | | | | |
|------|--|---|--------------------------|---------------------|
| No. | ① | ② | ③ | ④ |
| Name | Touch screen | Self-tapping screw ST4.2×9.5 MC (used to secure the rear cover of controller) | Rear cover of controller | Rubber band |
| QTY | 1 | 4 | 1 | 6 |
| No. | ⑤ | ⑥ | ⑦ | ⑧ |
| Name | Screw M4×12 (used to secure ground wire) | Screw ST4.2×16 FA (used to secure electric box cover) | Electric box cover | Matching resistance |
| QTY | 1 | 4 | 1 | 1 |

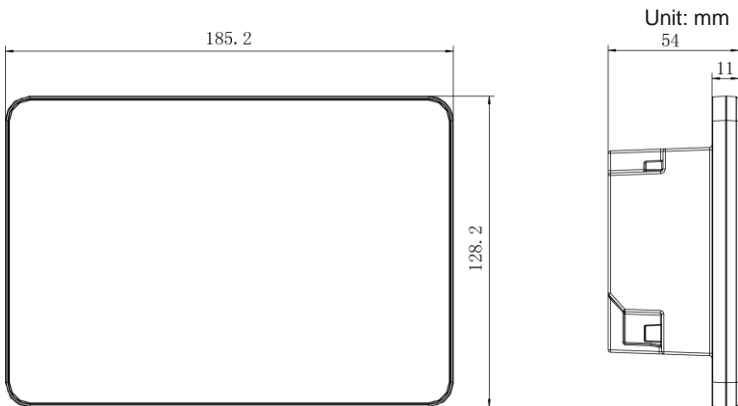

Fig.1.2 Dimension of Centralized Controller

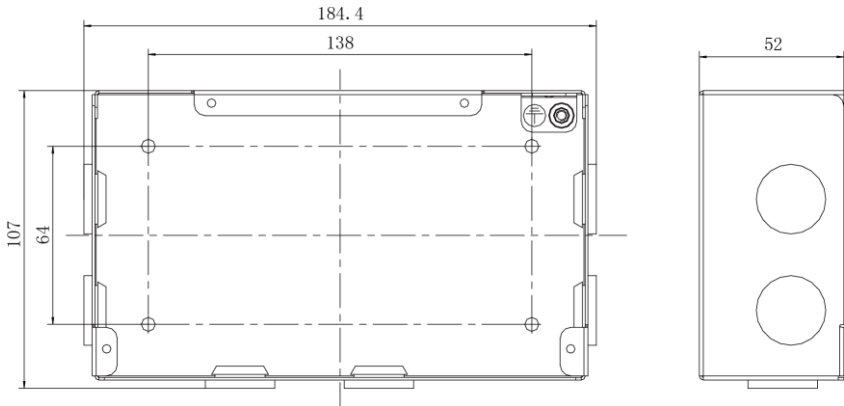

Fig.1.3 Dimension of Electric Box Cover

1.1 Installation Requirements

- (1) Communication cord of the centralized controller must be selected according to the table below. Never use the cable that is not in compliance with instructions of this manual.

| Network | Cord type | Cord standard | Cord size (mm ²) | Total length L(m) | Remark |
|-----------------|---|------------------|------------------------------|-------------------|--|
| Indoor network | Light/Ordinary polyvinyl chloride sheathed cord. (60227 IEC 52 /60227 IEC 53) | IEC 60227-5:2007 | ≥2×0.75 | L≤1000 | If cord size is 2×1 mm ² , communication cord can be stretched longer. But the total length can't exceed 1500m. |
| Outdoor network | | | | L≤250 | Total length of communication cord can't exceed 250m. |

 Notice:

- ① The cord shall be Circular cord (the cores shall be twisted together).
 - ② If unit is installed in places with intense magnetic field or strong interference, it is necessary to use shielded wire.
- (2) Never install the centralized controller in the following places:
- 1) Places with corrosive gas or serious dust, salt mist or oil smoke.
 - 2) Wet and damp places, with direct sunlight
 - 3) Places near high temperature objects or places where units might be splashed by water.

1.2 Wiring Instructions

(1) Wiring Ports

| Port print | G1, G2 | F1, F2 | A2, B2 | A3, B3 | L, N |
|------------|----------------|-----------------|-----------------|-----------------|------------|
| Meaning | CAN comm. port | 【reserved port】 | 【reserved port】 | 【reserved port】 | Power port |

(2) Power Supply

The smart centralized controller shall use independent power supply.

The range of input voltage: 110~240 VAC; Frequency range: 50/60Hz

Select power cord according to the following table. Never use the power cord that is not in compliance with instructions of this manual.

| Cord type | Cord standard | Cord size (mm ²) |
|--|------------------|------------------------------|
| Single-cord soft conductiveunsheathed cord (60227 IEC 08) | IEC 60227-3:2007 | 1.5 |

(3) Connection Method

There are three methods to connect centralized controller with the air conditioning system.

Method 1: Connect with indoor network

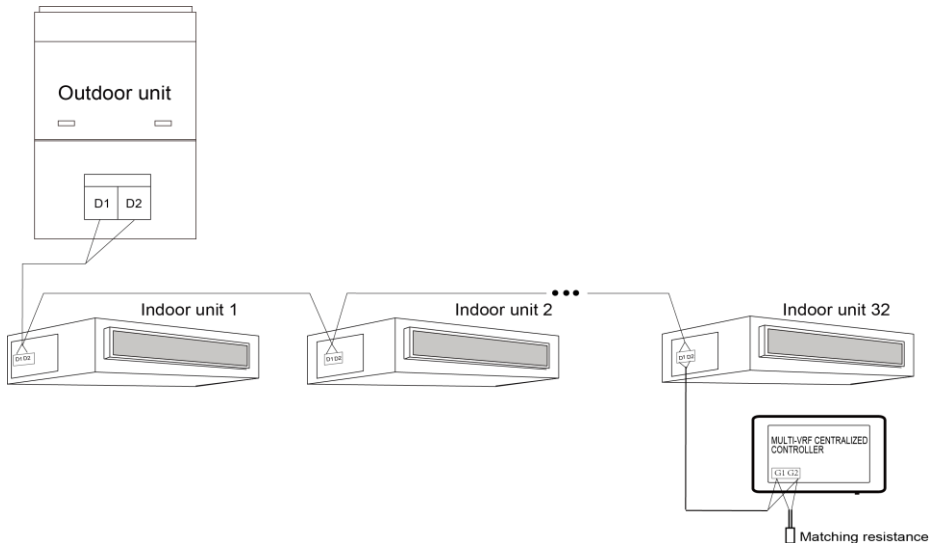

Fig.1.4 Centralized Controller Connected with Indoor Network

Method 2: Connect with outdoor network

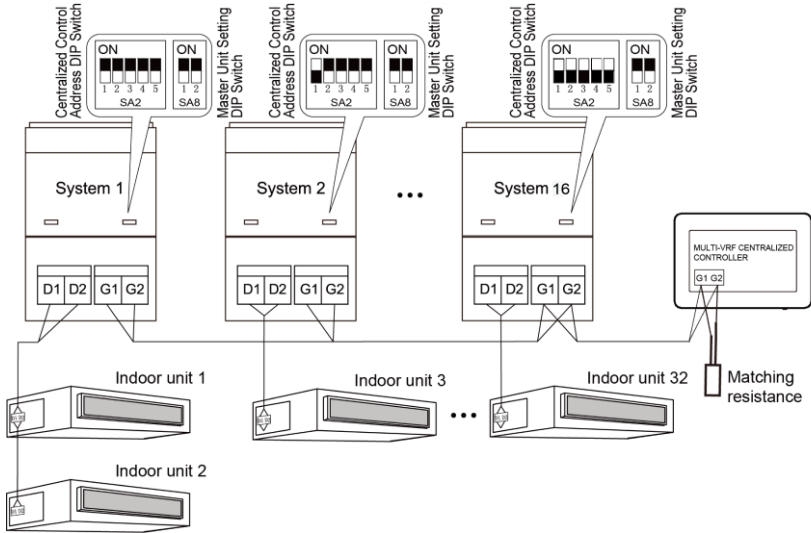

Fig.1.5 Centralized Controller Connected with Outdoor Network

Method 3: Connect with heat recollection mode converter Network

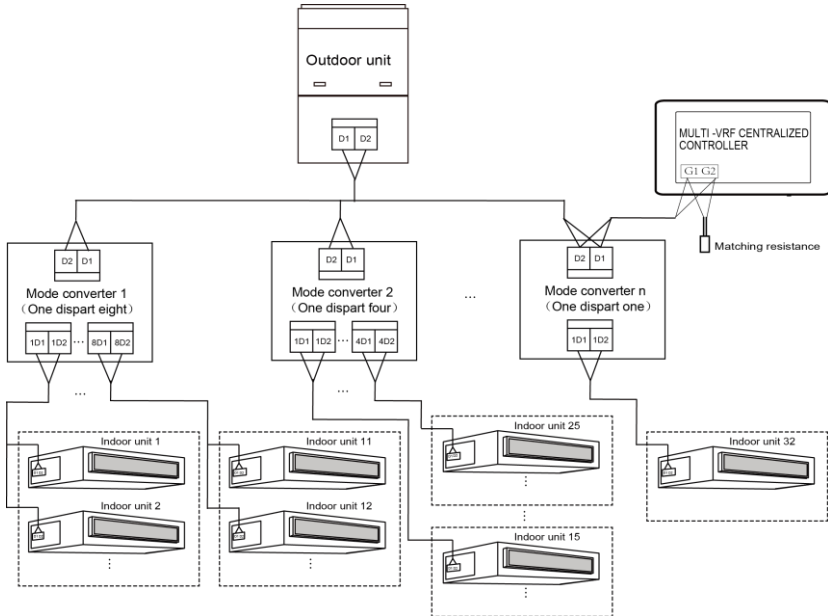

Fig. 1.6 Centralized Controller Connected with Heat Recollection Mode Converter Network

Wiring Instructions:

- ① The smart centralized controller is applicable to multi VRF units, connectable with network of indoor units or the network of outdoor units or mode converter network. One centralized controller can control up to 16 sets of outdoor system and up to 32 sets of indoor unit.
- ② If the centralized controller is to be connected with the network of indoor units, connect according to fig.1.4. The controller can connect with any one indoor unit in series, that is, connect the controller' s G1 and G2 ports with the D1 and D2 ports correspondingly with communication cords. When the controller is connected with the terminal unit of indoor network, a matching resistance needs to be added with the communication cords at the G1 and G2 ports.
- ③ If the centralized controller is to be connected with the network of outdoor units, connect according to fig.1.5. The centralized controller can only be connected with the terminal system of the outdoor network. A matching resistance needs to be added with the communication cords at the G1 and G2 ports.
- ④ The centralized control address DIP switch (SA2_Addr-CC) indicates the centralized control address required when different refrigerating systems are controlled in a centralized manner. The default factory setting is "00000".
- ⑤ If the centralized controller is to be connected with the network of heat recollection, connect according to Fig. 1.6. The method 2 is also applicable to centralized controller switching in heat recollection network.

If the centralized controller is to be connected with the network of outdoor units, set the DIP switch according to the following methods:

- 1) The DIP switch must be set on the master unit and set the Master Unit Setting DIP Switch(SA8) to "00".Otherwise, the setting is invalid.
- 2) On the same refrigerating system, the centralized control address DIP switch (SA2_Addr-CC) on a non-master unit is invalid, and it is unnecessary to change the settings.
- 3) The centralized control address DIP switch (SA2_Addr- CC) on the master unit of a refrigerating system must be set to “00000” , and this system is the master system.
- 4) The centralized control address DIP switch (SA2_Addr- CC) on the master unit of other refrigerating systems must be set as follows:

| SA2 | | | | | Address NO. |
|------|------|------|------|------|-------------|
| DIP1 | DIP2 | DIP3 | DIP4 | DIP5 | |
| 1 | 0 | 0 | 0 | 0 | 2 |
| 0 | 1 | 0 | 0 | 0 | 3 |
| 0 | 0 | 1 | 0 | 0 | 4 |
| 0 | 0 | 0 | 1 | 0 | 5 |
| 0 | 0 | 0 | 0 | 1 | 6 |
| 1 | 0 | 0 | 0 | 1 | 7 |
| 0 | 1 | 0 | 0 | 1 | 8 |
| 0 | 0 | 1 | 0 | 1 | 9 |
| 0 | 0 | 0 | 1 | 1 | 10 |
| 1 | 0 | 0 | 1 | 1 | 11 |
| 0 | 1 | 0 | 1 | 1 | 12 |
| 0 | 0 | 1 | 1 | 1 | 13 |
| 1 | 0 | 1 | 1 | 1 | 14 |
| 0 | 1 | 1 | 1 | 1 | 15 |
| 1 | 1 | 1 | 1 | 1 | 16 |

5) The centralized control address DIP switch (SA2_Addr- CC) cannot be the same between different refrigerating systems. Otherwise, address conflicts may occur and the unit cannot run properly.

1.3 Wiring Instructions

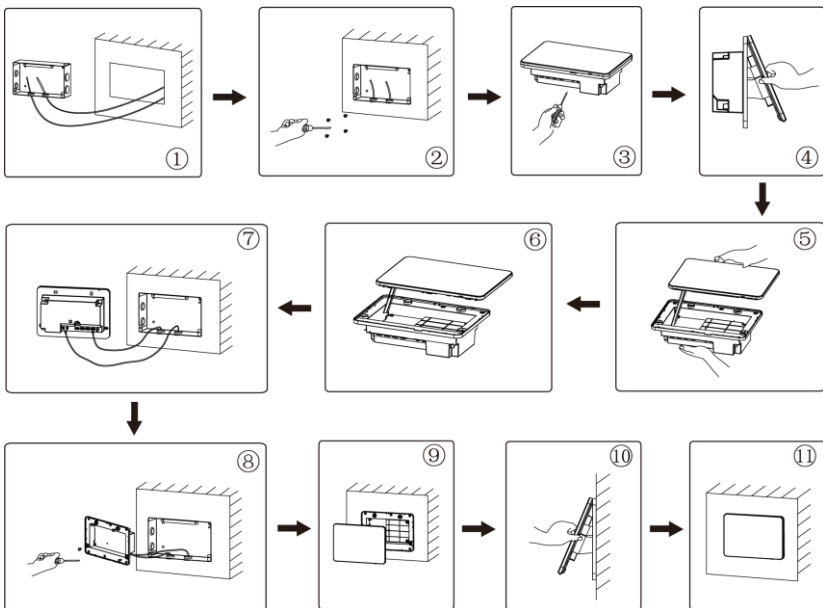

Fig.1.7 Installation Diagram

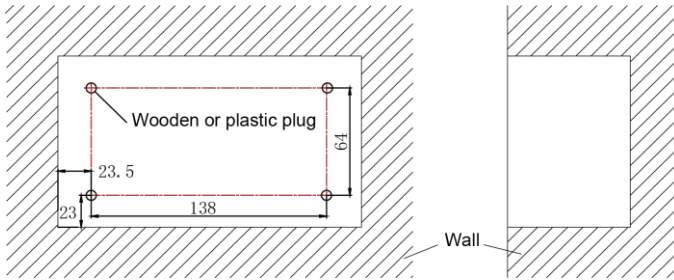

Fig.1.8 Diagram of Wooden or Plastic Plug

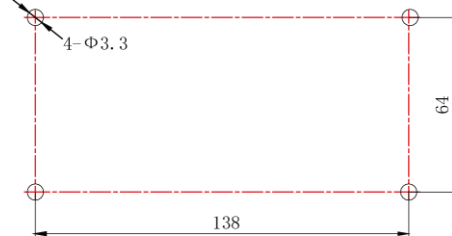

Fig. 1.9 Installation Holes of the Electric Box Rear Cover

Fig.1.7 is a simple installation procedure of centralized controller. Please pay attention to the following matters:

- (1) Before installation, first cut off the power supply of indoor unit. The power must be cut off during the whole installation process.
- (2) During the installation, be careful not to damage to touch screen.
- (3) Before installation, please make the following preparations:
 - 1) In case that the centralized controller is installed on wall, dig a hole that is the size of $180\text{mm} \times 107\text{mm} \times 62\text{mm}$ and peg 4 wooden or plastic plugs on the wall according to fig.1.8.
 - 2) In case that the centralized controller is installed inside the control cabinet, dig 4 installation holes on the surface of the control cabinet according to fig.1.9.
- (4) In step (1), pull out the power core and communication cord, and then lead them separately from the wire orifice of the electric box rear cover. Never lead the cords through a same orifice.
- (5) In step (2), locate the electric box rear cover to the installation holes of the wall with screw $\text{ST4.2} \times 16 \text{ FA}$.
- (6) In step (6), pull out the wire connecting the touch screen and controller's rear cover. Put the touch screen on a safe place.
- (7) In step (7), connect the communication cords to G1, G2 terminals, and connect the neutral wire and live wire to the N, L terminal; connect the ground

wire to position ⊕ on the electric box rear cover. Secure it with screw M4 × 12.

(8) In step (8), locate the controller's rear cover onto the electric box rear cover with screw ST4.2 × 9.5 TC.

(9) In step (9), connect the wire between touch screen and controller's rear cover.

1.4 Removal Procedure

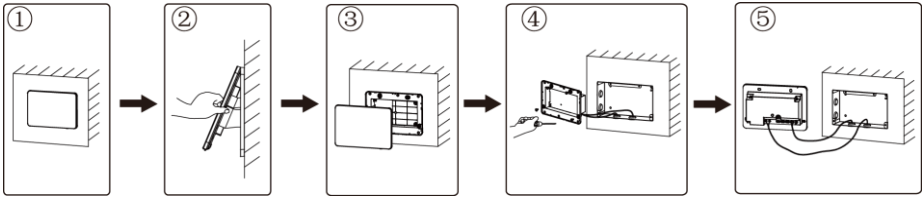

Fig.1.10 Diagram of Removal

2 DISPLAY AND WORKING INSTRUCTIONS

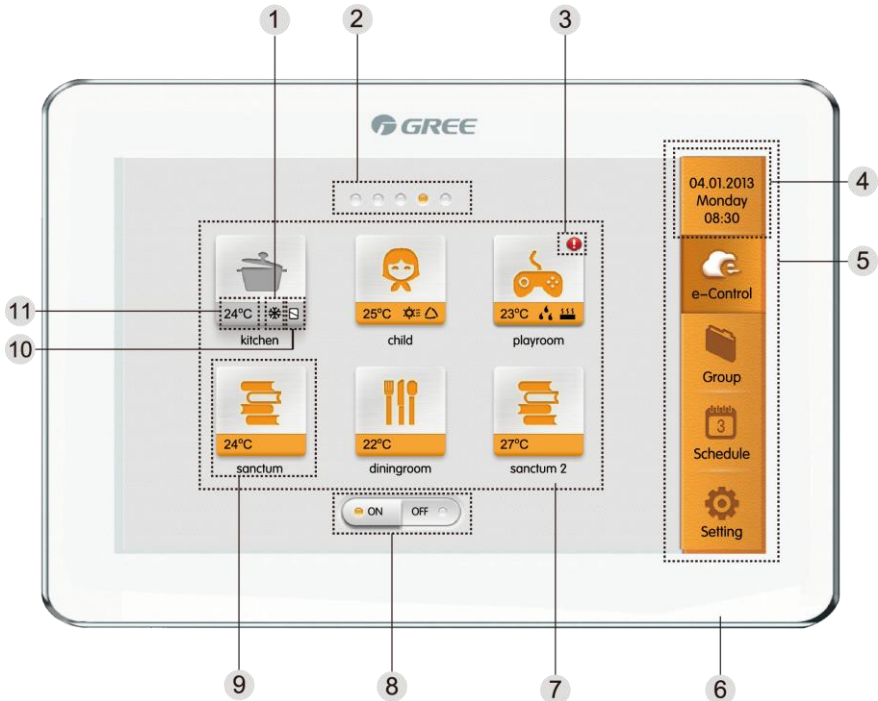

















Fig.2.1 Main Page

2.1 Main Page Display and Buttons

| No. | Name | Instructions |
|-----|-------------------|--|
| ① | Operation mode | When indoor unit is on, the current operation mode will be displayed:  Auto  Cooling  Dry  Fan  Heating  Floor heating  Space heating  3D heating |
| ② | Current page | The total pages of the controlled indoor unit and the current page. |
| ③ | Error status | Error icon will be displayed if indoor unit is malfunctioning. |
| ④ | Time zone | The present date, week and time |
| ⑤ | Menu | There are 4 buttons: e-Control, Group, Schedule and Setting. Press the button to enter the corresponding page: |
| ⑥ | Touch button | <ul style="list-style-type: none"> ● Press the Touch Button to turn on/off the screen of centralized controller. ● Press and hold the Touch Button for 5sec to restart to centralized controller. |
| ⑦ | IDU display | Display in separate page the list of indoor units that are controlled by the centralized controller. Sliding left or right can turn over the page. |
| ⑧ | All on/off button | Press this button to turn on or off all air conditioning equipment. |
| ⑨ | IDU icon | <ul style="list-style-type: none"> ● Press the button to enter the page of indoor unit control. ● Orange icon indicates that IDU is on while the grey icon indicated that IDU is off. |
| ⑩ | Shield status | This icon will be displayed when indoor unit is in shield status. |
| ⑪ | Set temperature | When indoor unit is on, set temperature will be displayed here. |

2.2 General Buttons

| Display | Name | Meaning | Display | Name | Meaning |
|---|--------|---|---|--------|---|
|  | Return | Press this button to return to the previous page |  | Cancel | Press this button to cancel the current setting and return to the previous page |
|  | Save | Press this button to save the current setting and return to the previous page |  | Add | Press this button to add group or schedule |
|  | Edit | Press this button to edit the e-Control, group or schedule |  | Delete | Press this button to delete group or schedule |
|  | Up | Press this button to increase value or select the previous option |  | Down | Press this button to decrease value or select the next option |

2.3 Buttons Working Instructions

The centralized controller uses a capacitive touch screen so that user can operate the units by just touching the screen.

Buttons on the screen are presented in the following ways:

(1) Icon

Icon button can be operated directly. See section 2.2 for more details.

(2) Icon + Text

According to the meaning of Text, turn on or off or select a certain function, or enter a certain page. This type of button has 2 or 3 kinds of status based on the specific function.

Meaning of status (take Sleep Button as an example):

Light grey indicates invalid/not selectable. Sleep function is invalid and can't be selected. Different cases for models.

Grey indicates off/not selected. Sleep function is off. Pressing the grey sleep button can turn on the sleep function.

Orange indicates on/selected. Sleep function is on. Pressing the orange sleep button can turn off the sleep function.

(3) Sliding

Sliding left/right or up/down can turn over the page. For example the home page list of indoor units, schedule, etc.

(4) Sliding bar

Press and hold the sliding bar to drag up/down or left/right and to adjust the value. For example the fan speed setting, backlight setting, etc.

(5) Zone button

On the management pages of e-Control functions, group control and schedule, as indicated in fig.2.2 (the home page of group control), each rectangle frame constitutes a zone button.

Press the zone button, then the turning on/off of corresponding function or the corresponding page will pop in.



Fig.2.2 Zone Buttons on the Group Control Page

3 FUNCTIONS DESCRIPTION

3.1 All ON/OFF

On the home page, press the “All OFF” button to turn off all indoor units.

Press the “All ON” button to turn on all indoor units. Then indoor units will work according to memory.

3.2 Single Unit Control

On the home page, press the icon of indoor unit to enter the single unit control.

Parameters of single unit control include parameters of general control and advanced control.



Fig.3.1 Page of Single IDU Control

(1) General Control Parameters

1) On/off

Press the on/off button to turn unit on or off.

When unit is turned off, mode, temperature, fan speed and swing can't be set.

2) Mode setting

Press the Mode buttons to set unit's operation mode.

Modes for indoor units of different series are not all the same.

If a certain mode is not available in the indoor unit, the icon of the corresponding mode cannot be selected.

Note:

- ① Auto mode can only be set in the master indoor unit.
- ② Heat recollection system have no master indoor unit. When the indoor unit of the same branch is connected into one indoor unit, the auto mode can be set; when the quantity of indoor unit in the same branch is more than one set, the auto mode cannot be set; other modes can be freely switched.

3) Temperature setting

Press the up Or down buttons to adjust temperature. Each time pressing the button will increase/decrease the temperature by 1. Holding down the button can increase/decrease temperature continuously.

Pressing the button "Setting Temp" can switch to "indoor temp" or "outdoor temp". The corresponding temperature value will be displayed.

4) Fan speed setting

Press or drag the fan speed bar to set unit's fan speed.

Note: Unit defaults to low fan speed in dry mode. Fan speed cannot be set in drying or floor heating mode.

5) Swing setting

Pressing the button "Up-Down Swing" or "Left-Right Swing" can turn on or off the swing function.

Note: Swing types for indoor units of different series are not all the same.

6) Malfunction View

When indoor unit fails to function well, press  to view the information of

malfunctions.

(2) Advanced Control Parameters

Press Advance Button to enter the advance page.

Press icon buttons to turn on or off the corresponding function.



Fig.3.2 Advance Page

- 1) Functions of Sleep, Quiet, E-Heater, Absence and Rapid can only be effective when unit is turned on.
- 2) When sleep function is on, quiet function will be turned on subsequently. Sleep function will not be effective under auto, fan or floor heating mode.
- 3) Absence function can only be turned on in heating mode. When absence function is on, set temperature is 8°C.
- 4) Rapid cool function can only be effective in cool mode. Likewise, rapid heat function can only be effective in heat mode.
- 5) When shield all function is on, other shield buttons will be invalid.

3.3 Water /Floor control

On the home page, press the icon of water/floor unit to enter the water/floor control interface.

Water/Floor control parameters include water heating control parameter and floor heating control parameter. It can be switched via Water | Floor button.

Notes:

- (1) When there is only one function can be selected (water or floor), it can only display the water heating or floor heating function interface, and cannot be switched to another interface;
- (2) Only when it is connected to hot water generator, water heating and floor heating functions are applicable, the interface can be switched and displaced according to the above instructions;

3.3.1 Water Control Parameter



Fig. 3.3 Page of Water heating Control

(1) On/Off

Press the on/off button to turn unit on or off.

When the unit is off, it cannot set the mode, temperature and preset function, while it can set the sterilization function.

(2) Mode Setting

Press the Mode buttons to set unit's operation mode.

There are three modes: HotWater, Booking, Night. These three modes can not be simultaneously conducted, it can only choose one of the modes.

HotWater mode: the water tank or hot water generator will start up or stop heating water according to the current set water temperature.

Booking mode: book the water heating time, the water tank or hot water generator

will start up the unit in advance according to the actual water temperature, and will decide the on and off of water tank or hot water generator according to the temperature difference between actual water temperature and the setting water temperature. The water tank or hot water generator will close down the unit 1~4 hours later after the preset time. Once this mode is set, it will circularly operate every day.

Night mode: the fixed period for providing hot water is from 00:00 to 06:00, the water tank or hot water generator will start up in this period, and will decide the on and off of water tank or hot water generator according to the temperature difference between actual water temperature and the setting water temperature. If it is not within this period, the water tank or hot water generator will close down the unit. Once this mode is set, it will circularly operate every day.

(3) Temperature Setting

Press the button of “Current Temp” can view the current temperature of hot water. After pressing “Setting Temp”, the temperature value can be adjusted by pressing up and down buttons; the temperature value will increase or decrease by every pressing the button for once. The temperature value will be continuously increased or decreased by long pressing the button.

Under the standard HotWater, Booking and Night modes, the temperature setting range is: 35℃~the maximal adjustable temperature 55℃, the acquiescence maximal temperature is 50℃.

(4) Available Hot Water Volume



The water volume can be display in real time, there are five sections of water volume: 100%, 80%, 60%, 40%, 20%, when the water volume is less than 20%, it will flicker.

(5) Function Setting of Water Heating

Under on /off status of water heating, the following functions can be set:

| Water On/Off | Functions |
|-----------------------|--|
| Start-up Water mode | Sunflower, Auto, Sterilization, Fast, Shield |
| Start-up Booking mode | Auto, Sterilization, Fast, Shield |
| Start-up Night mode | Auto, Sterilization, Fast, Shield |
| Water heating off | Sterilization |

Sunflower function: find the highest outdoor temperature by recording the history data of outdoor temperature to define the time to heat the water, so as to achieve energy saving.

Auto function: the setting temperature of water heating will be automatically provided by water heater according to the outdoor ambient temperature, there is no need to set by the user, and the water temperature cannot be adjusted via  or  buttons.

Sterilization function: it will conduct high temperature sterilization when the water temperature in the water tank is heated to 65~70°C (adjustable) within the required set time. When the high temperature sterilization is set to be “once”, then the sterilization will be valid for once; when the high temperature sterilization is set to be “circular”, the sterilization will be circularly valid, then it can set the circulated days and presetting sterilization time. When the sterilization function is activated, it will display .

Fast function: start up the compressor and electric heating water under the allowable conditions of outdoor unit, the fast water heating function can be set to be valid for once, when the water tank/hot water generator has reached to heat preservation status, the fast water heating function will be cancelled for energy saving. After the water heating is closed down, the fast water heating function is cancelled.

Shield function: it can conduct shield function by pressing related functional buttons of wired controller to nullify such operation.

(6) Malfunction View

When the water heater fails to function well, press  to view the information of malfunctions.

3.3.2 Floor control parameter



Fig. 3.4 Page of Floor Heating Control

(1) On/off

Press the on/off button to turn unit on or off.

When the unit is off, the mode and temperature cannot be set.



(2) Temperature Setting

Press the button of “Current Temp” to view the current water yielding temperature. After pressing “Setting Temp”, the temperature value can be adjusted by pressing up and down buttons, the temperature value will increase or decrease by every pressing the button for once. The temperature value will be continuously increased or decreased by long pressing the button. Floor heating water yielding temperature range: 25°C~the highest water yielding temperature of floor heating 45°C.

(3) Function Setting of Floor Heating

Under the on/off status of floor heating, the functions can be set as below:

| Floor on/off | Function | Remarks |
|--------------|-----------------------------|---|
| Floor on | Auto, Fast, Absence, Shield | |
| Floor off | Absence | It will be valid only when the indoor unit is set together with shunt valve |

Auto function: the floor heating water yielding temperature will be automatically provided by hot water generator according to the outdoor ambient temperature, there is no need to set by the user, and the water temperature cannot be adjusted via  or  buttons.

Fast function: start up the compressor and electric heating under the allowable conditions of outdoor unit.

Absence function: when the user is absence, it will maintain certain degree of water temperature to prevent the pipelines from being frozen up and prevent the indoor equipment from being destroyed.

Shield function: it can conduct shield function by pressing related functional buttons of wired controller to nullify such operation.

(4) Malfunction View

When the floor heating fails to function well, press  to view the information of malfunctions.

3.4 e-Control Function

On the home page, pressing e-Control button can enter the page of e-Control.

e-Control includes 5 short-cut modes (Sleep, Bath, Home, Leaving and Stay out) and 3 DIY modes.

User may reset the functions of different modes according to actual needs.



Fig.3.5 e-Control Page

(1) Turn on e-Control

Pressing the zone button can turn on the selected short-cut mode.

Note: e-Control can be turned on repeatedly. When it is turned on, centralized controller will send out one control order according to the mode setting.

(2) Edit e-Control

Press  to edit the mode parameters.

Settings of mode parameters are the same as single unit control.

After setting is done, press  to save the setting.

(3) Add equipment

On the edition page, press  and then the page of equipment selection will pop in.

User can set the indoor unit that works according to the current modes. Pressing the icon of indoor unit can select or cancel the unit. Press  to save the setting.

Note: For a same indoor unit, different modes can be set at the same time. In this case, indoor unit will work according to the latest energized mode.

(4) Restore default settings

On the edition page, press the button **Reset Default** to restore the ex-factory default settings.

Ex-factory default settings:

| Mode | Subject | On/off | Mode | Set temp | Fan speed | Swing | Function |
|---------|----------|--------|------|----------|-----------|-------|-------------------------------|
| Sleep | All IDUs | On | Heat | 27°C | Auto | Off | Turn on sleep function |
| Home | All IDUs | On | Cool | 27°C | Auto | Off | -- |
| Leaving | All IDUs | Off | -- | -- | -- | -- | -- |
| Stayout | All IDUs | On | Heat | 8°C | Auto | Off | Turn on the stay-out function |
| Bath | All IDUs | On | Heat | 27°C | Auto | Off | -- |
| DIY | All IDUs | On | Heat | 27°C | Auto | Off | -- |

3.5 Group Control

Press the Group button on the home page to enter the page of group function.

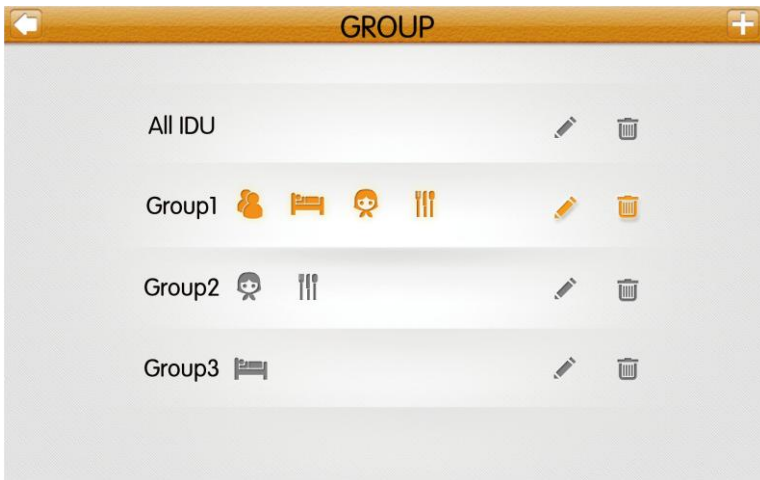



Fig.3.6 Group Page

(1) Group control

Press the zone button to enter the page of group control. Control parameters are the same as single unit control.

Press button  to send out the group control order.

(2) Edit group

Press  to enter the page of group editing.

User can set the group name and add indoor units to the group.

Press  to save the setting.

Note: 1 set of indoor unit can be set in up to 5 groups

(1) Add group

Press  to add new groups. Then the page of group editing will pop in. User can set the group name and add indoor units to the group.

(2) Delete group

Press  to delete the selected group.

3.6 Schedule Management

Press Schedule button on the home page to enter the page of schedule management.

(1) Open the schedule

Press the zone button to open or close the schedule.

 indicates schedule is open.

 indicates schedule is closed.

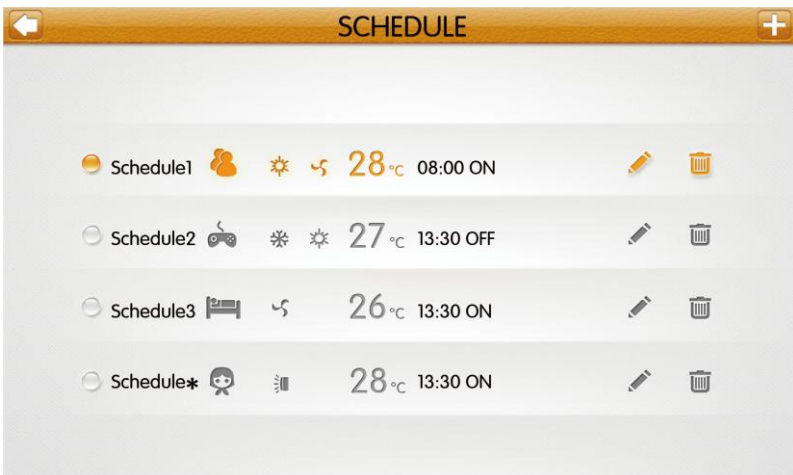

Fig.3.7 Schedule Page

When schedule is open, centralized controller will send out the control order automatically according to the time and parameters set by the schedule.

(2) Edit schedule



Press  to enter the page of schedule editing.



Fig.3.8 Page of Schedule Editing

Press  to save the schedule setting.

1) Setting method of schedule control parameters is the same with that of the single indoor unit control.

2) Add equipment

Press button  to enter the page of equipment selection. User may set the indoor unit that works according to the current schedule.

Note: For a same indoor unit, different schedules can be set at the same time. In this case, unit will work according to the schedule setting that is previously energized.

3) Repeat schedule

Press button  to enter the setting page. User can set the schedule work repeatedly according to weeks.

4) Time setting

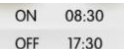
Press  to enter the page of time setting.

User can set the time for unit to turn on/off automatically.

Note: The time to activate or stop unit can be set at the same time, but they must not be the same.

5) Add exception

Press button **Exception** to enter the setting page of schedule exception.

The setting method of the control parameters of schedule exception are the same with the setting method of the parameters of ordinary schedule. Press  to save the set parameters.

On the setting page of exception, press button **Add Date** and then the calendar will pop in.

User can select the date to activate or cancel exception. Press  to save the selected date.

Notes: When schedule exception has been set, air conditioner will send out the control order on the exception date according to the time and parameters set by the schedule exception.

User may add several exception dates.

(3) Add schedule

Press  to add new schedules. Then the schedule editing page will pop in for user to set relevant parameters.

Note: User may add up to 28 schedules.

(4) Delete schedule

Press  to delete the selected schedule.

3.7 Local Setting

Press Setting on the home page to enter the setting page.

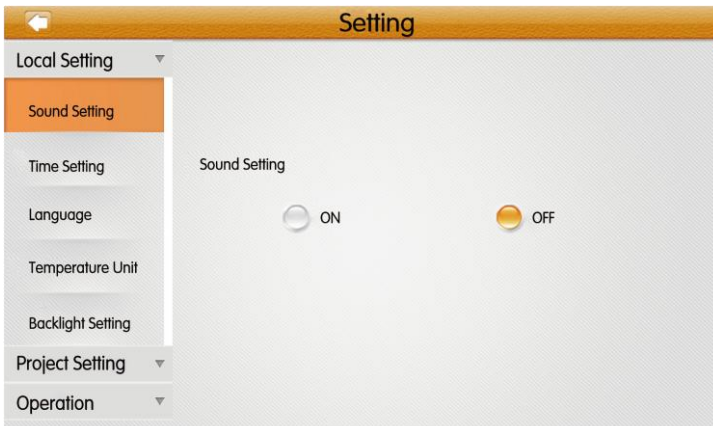

Fig.3.9 Setting Page

Press the button **Local Setting** ▼ to switch to the setting options of the current unit.

Select the needed option at the left side column. Sliding up and down can turn over the page.

Set the corresponding content at the right side.

Local setting includes:

Sound, language, temperature unit, background, mutual exclusion

Press the button to select one kind of setting.

(1) Time setting

- 1) Set time format: either 12hr clock or 24hr clock
- 2) Set the date and time of the centralized controller system

(2) User password

Press the button can activate or inactivate user password.

When password is activated, it can be set or changed in 4~10 numbers or characters. Original password is blank.

Press the button **Save** to save the password.

Note: If user password is activated, user needs to input password to enter the control page when centralized controller is turned on or activated.

(3) Backlight setting

Pressing this button can set the timeout period of screen backlight. Screen will be shut off and the centralized controller will enter sleep mode when the timeout period is over. Pressing or dragging the sliding bar can adjust the backlight degree.

Note: When centralized controller is in sleep mode, use can wake it up by touching any part of the touch screen or the touch button at the right bottom of the screen.

(4) Customer Service

User can set the name and phone number of the local customer service center for the convenience of acquiring immediate solutions and technical support.

Press the button **Save** to save the setting.

(5) Restore default settings

Press the button **Reset Default** to restore local setting, e-Control setting, group setting, schedule setting, names and icons of indoor units, and other relevant ex-factory default settings.

- 1) When switching between indoor network and outdoor network, or reset unit IP,

restore the ex-factory setting for centralized controller.

- 2) After debugging for the centralized controller is finished, connect in to the network. If connect the centralized controller to the network during debugging process, it needs to restore the defaulted ex-factory setting.

3.8 Engineering Setting

On the home page, press setting to enter into setting interface.

Press the **Project Setting** button to switch to engineering setting, the operation method is the same as the setting of this unit.

(1) Indoor unit register

Enter into the indoor unit register interface, select the chosen indoor unit according to the displayed engineering No. of indoor unit icon, and then press  to save, it will display the registered indoor unit in the home page.

Notes: There are 32 sets of indoor units can be registered at most.

(2) Name&Icon setting

Switch to name&Icon setting interface to select the engineering No., and set the name and icon of indoor unit.

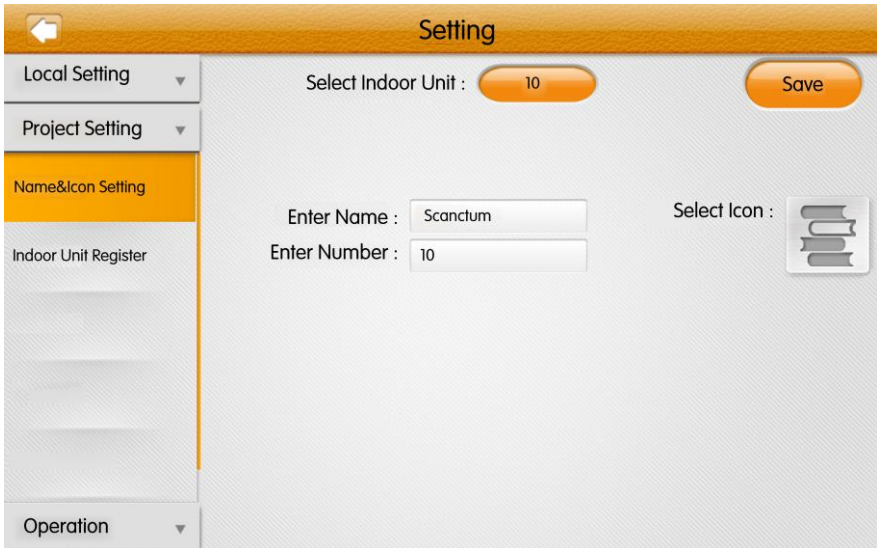

Fig. 3.10 Setting Page of Indoor Unit

Press the button  to select the required indoor unit that needs to be set.

(1)Name: can input number or letter (it should not be over 10 letters)

(2)Icon: press to select the preset icon.

(3)Engineering No.: press , it can be set to be 1-255.

(4)Press **Save** button to successfully save the setting. Then the indoor unit list in the home page will display the new name and icon of indoor units.

3.9 Operation Notice

Press Setting on the homepage to enter the setting page.

Press the button to switch to operation notice. The operation method is the same with that of the local setting.

On the page of operation notice, user can view the information of the local unit, customer service information, operation instructions and other notices.

GREE ELECTRIC APPLIANCES, INC. OF ZHUHAI

Add: West Jinji Rd, Qianshan, Zhuhai, Guangdong, China, 519070
Tel: (+86-756) 8522218 Fax: (+86-756) 8669426
E-mail: gree@gree.com.cn www.gree.com



6617000013