



Owner's Manual

Original Instructions

Centralized Controller

Model:
CE58-00/EF(CM)

Thank you for choosing this product. Please read this Owner's Manual carefully before operation and retain it for future reference.

If you have lost the Owner's Manual, please contact the local agent or visit www.gree.com or send an email to global@cn.gree.com for the electronic version.

GREE ELECTRIC APPLIANCES, INC. OF ZHUHAI

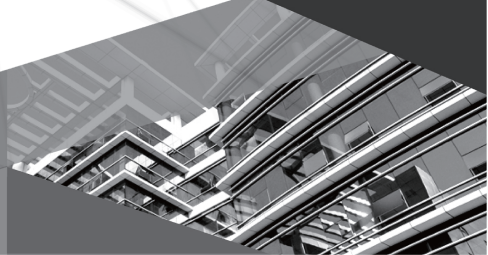

To Users

Thank you for selecting Gree product. Please read this instruction manual carefully before installing and using the product, so as to master and correctly use the product. In order to guide you to correctly install and use our product and achieve expected operating effect, we hereby instruct as below:

- (1) This appliance is not intended for use by persons (including children) with reduced physical, sensory or mental capabilities, or lack of experience and knowledge, unless they have been given supervision or instruction concerning use of the appliance by a person responsible for their safety. Children should be supervised to ensure that they do not play with the appliance.
- (2) This instruction manual is a universal manual, some functions are only applicable to particular product. All the illustrations and information in the instruction manual are only for reference, and control interface should be subject to actual operation.
- (3) All the illustrations and information in the instruction manual are only for reference. In order to make the product better, we will continuously conduct improvement and innovation. If there is adjustment in the product, please subject to actual product.
- (4) If the product needs to be installed, moved or maintained, please contact our designated dealer or local service center for professional support. Users should not disassemble or maintain the unit by themselves, otherwise it may cause relative damage, and our company will bear no responsibilities.

Contents

1 Safety Notices (Please Do Follow)	1
2 User Notices	1
3 Instruction of Installation	2
3.1 Requirements of Installation	3
3.2 Instruction of Wiring	4
3.3 Steps for Installation	14
3.4 Steps for Disassembly	16
4 Instruction for Display and Operation	17
4.1 Main Page Display and Key Instructions	17
4.2 Instruction for Icons of General Buttons	18
4.3 Instructions of Button Operation	18
5 Instruction for Functions	20
5.1 Notification Page	20
5.2 Group	21
5.3 One-button Control	22
5.4 Air Conditioner Control	23
5.5 Water Heating/Floor Heating Control	25
5.6 Fresh Air Control	29
5.7 Floor Heating Adapter (Refrigerant Floor Heating) Control	30
5.8 Batch Control	31
5.9 Function Page	32
6 Packing List	42

1 Safety Notices (Please Do Follow)



Warning: If these safety notices are not followed, it may cause serious damage to the unit or personal injury or death.



Caution: If these safety notices are not followed, it may cause moderate damage to the unit or personal injury.



It means the matter that must be prohibited! Improper handling may result in death or serious injury.



It means the matter that must be followed! Improper operation may cause personal injury or property damage.



Warning!

This product can't be installed in corrosive, flammable and combustible environment or the special places (such as kitchen). Otherwise, the unit may can't operate normally or the service life of the unit will be shortened. It may even cause fire hazard or serious injury. As for above special places, anti-corrosion or explosion-proof products should be adopted.

2 User Notices

- (1) All indoor units must be supplied with unified power.
- (2) Make sure communication cord is connected with the proper port, otherwise there may occur communication malfunction.
- (3) Never knock on, throw or frequently detach the centralized controller.
- (4) Never operate the centralized controller with wet hands.
- (5) Never scratch the screen of centralized controller by hard or sharp objects.
- (6) If the centralized controller is connected with the outdoor network or the last indoor unit of the indoor network, then a matching resistance must be connected between G1 and G2 ports.
- (7) Working environment temperature range of centralized controller: 0~48°C.

3 Instruction of Installation

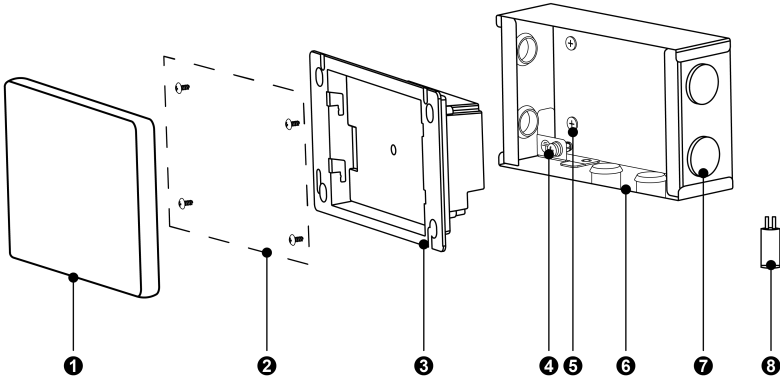

Fig. 3.1 Component of Controller

No.	①	②	③	④
Name	Touch screen of controller	Tapping screw ST3.9×9.5 PA (for fixing the controller to the electric control box)	Rear cover of controller	Screw M4×12 (for fixing earth wire)
QTY	1	4	1	1
No.	⑤	⑥	⑦	⑧
Name	Tapping screw ST4.2×16 FA (fix the electric box to the wall)	Electric box	Rubber ring	Matching resistor
QTY	4	1	6	2

Unit: mm

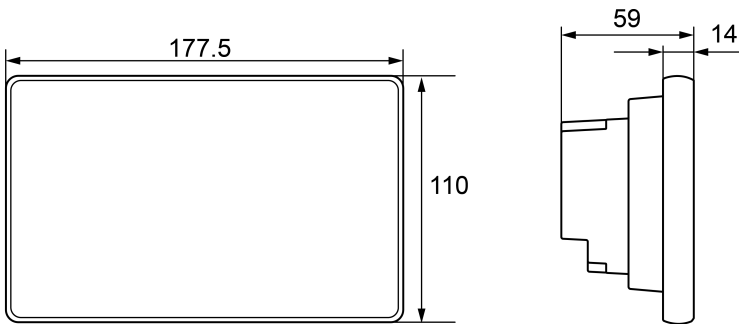

Fig. 3.2 Dimension of Centralized Controller

Unit: mm

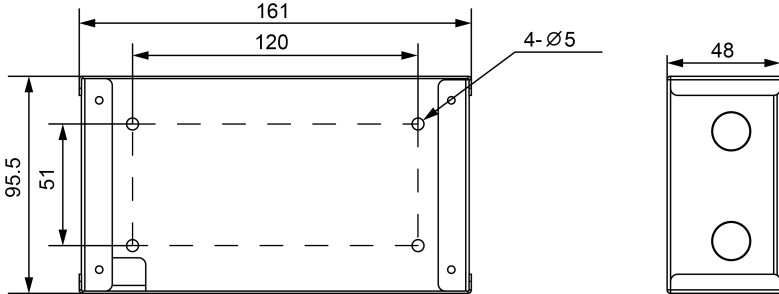

Fig. 3.3 Dimension of Electric Box

3.1 Requirements of Installation

- (1) Communication cord of the centralized controller and Multi-VRF (CAN Network) must be selected according to the table below. Never use the cable that is not in compliance with instructions of this manual.

Network	Cord type	Cord standard	Cord size (mm ² /AWG)	Total length L(m/feet)	Remark
Indoor network	Light/ Ordinary polyvinyl chloride sheathed cord. (60227 IEC 52 /60227 IEC 53)	IEC 60227- 5:2007	2×0.75~ 2×1.25 (2×AWG18~2×AWG16)	L≤1000m (L≤3280feet)	If cord size is 2×1mm ² (2×AWG16), communication cord can be stretched longer. But the total length can't exceed 1500m(4921feet).
Outdoor network				L≤500 (L≤1640feet)	Total length of communication cord can't exceed 500m(1640feet).

Caution!

If the unit is installed in a place with strong electromagnetic interference, the communication wire of the centralized controller must use a shielded twisted pair.

- (2) The communication cord between the centralized controller and the L-CAC&Split unit (Modbus network) must be selected according to the requirements in the table below:

Type of wire material	Wire diameter of wire	Wire standard	Remark
V twisted-pair (2-core)	24AWG (2×0.6mm)	TIA/EIA-568-A	When the communication distance exceeds 800m, it is necessary to add a photoelectric isolation relay

(3) It is strictly forbidden to install the centralized controller in the following locations:

- 1) Places with corrosive gas or severe dust, salt spray, oil fume.
- 2) Places that are humid or exposed to direct sunlight.
- 3) Places where are close to high-temperature objects or places prone to splashing water.

3.2 Instruction of Wiring

3.2.1 Instruction of Wiring Interface

	A1,B1	A2,B2	F1/F2	G1/G2	L,N
Meaning	Interface of L-CAC&Split unit	BAS interface (reserved)	Fire/input inspection interface	CAN communication interface	Power supply interface
Instruction of interface parameter	RS485	RS485	Signal of dry contact	CAN	100~240VAC 50/60Hz

3.2.2 Way of Power Supply

- (1) The centralized controller is powered by an independent power supply.
- (2) The power input voltage range is 100~240VAC, and the frequency range: 50/60Hz.
- (3) The power cord should be selected according to the requirements in the table below. It is strictly forbidden to choose a power cord that does not meet the requirements of this manual.

Cord type	Cord standard	Cord size (mm ²)
Single-cord soft conductive unsheathed cord (60227 IEC 08)	IEC 60227-3:2007	1.5

3.2.3 Wiring Method of Multi-VRF Unit (CAN Network)

There are three methods for the centralized controller to connect to air conditioning system.

Method 1: Connect to the network of indoor unit

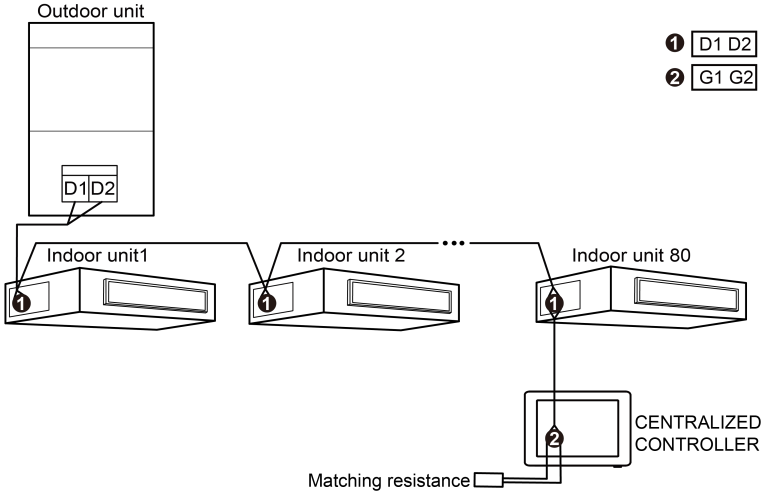

Fig. 3.4 Centralized air conditioner connects to network of indoor units

Method 2: Connect to network of outdoor unit

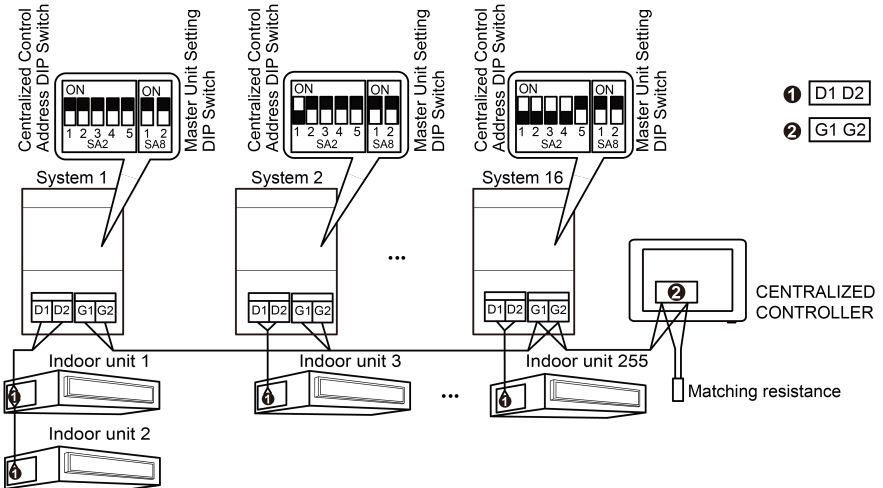

Fig. 3.5 Centralized controller connects to network of outdoor units

Method 3: Connect to network of heat recovery mode converter

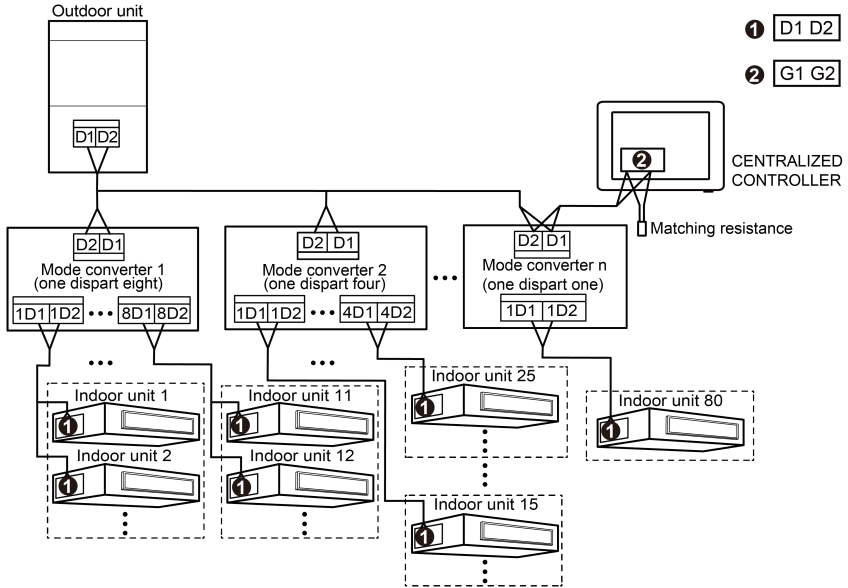

Fig. 3.6 Centralized controller connects to network of heat recovery mode converter

Instruction of wiring:

- (1) The centralized controller is suitable for multi-VRF unit and can be connected to the network of indoor units or outdoor units. The total number of outdoor units controlled by a centralized controller shall not exceed 16, and the total number of indoor unit controlled by one centralized controller shall not exceed 255.
- (2) When the centralized controller is connected to the indoor unit network, connect the network as shown in Figure 3.4. The centralized controller can only be connected to the last system of the outdoor unit system, and needs to be connected with matching resistors at the G1 and G2 interfaces together with the communication cable.
- (3) When the centralized controller is connected to the outdoor unit network, connect the network as shown in Figure 3.5. The centralized controller can only be connected to the last system of the outdoor unit system, and needs to be connected with matching resistors at the G1 and G2 interfaces together with the communication cable.

- (4) The centralized control address dial code (SA2_Addr-CC) is the centralized control address when centralized control is required between different refrigeration systems; and the factory default setting is "00000".
- (5) When the centralized controller is connected to the heat recovery network, connect the network as shown in Figure 3.6. Method 2 is also applicable to the centralized controller connected to the heat recovery network.

When using mode 2, the centralized controller is connected to the network of outdoor unit, and the centralized control address of the outdoor unit needs to be set by dial codes. The steps are as follows:

- 1) This dial code must be set on the master outdoor unit, and the setting code (SA8) of the master control unit should be set to "00", otherwise it will be invalid.
- 2) The setting of centralized control address dial code for the non-master outdoor unit of the same refrigeration system is invalid, and there is no need to change the setting.
- 3) The centralized control address dial code for one of the master control outdoor units of one of the refrigeration systems must be set to "0000/", and this system is the master control system.
- 4) The centralized control address dial codes for master control unit of other refrigeration system are set as follows:

SA2					Address No.
DIP1	DIP2	DIP3	DIP4	DIP5	
1	0	0	0	/	2
0	1	0	0	/	3
1	1	0	0	/	4
0	0	1	0	/	5
1	0	1	0	/	6
0	1	1	0	/	7
1	1	1	0	/	8
0	0	0	1	/	9
1	0	0	1	/	10
0	1	0	1	/	11
1	1	0	1	/	12
0	0	1	1	/	13
1	0	1	1	/	14
0	1	1	1	/	15

SA2					Address No.
DIP1	DIP2	DIP3	DIP4	DIP5	
1	1	1	1	/	16

- 5) The dial codes of the centralized control addresses of each refrigeration system cannot be the same, otherwise there will be an address conflict error and the unit cannot operate.

Notes:

- ① The fifth DIP5 of the centralized control address dial code is invalid.
- ② If the centralized control address dial code (SA2-Addr-CC) of one of the multi-VRF system's master control unit is set to "1111X", the system is the master mode system, and the operation mode of the master mode system shall prevail. Indoor units of other systems cannot be set to a mode that conflicts with the master mode system.

For example: when the master mode system is set to cooling mode, the indoor units under other systems cannot be set to heating mode.

Note: The method to solve the address conflict:

Method: In the master control outdoor unit of the master system, for the main board with 7 buttons, press SW3 to enter the functional setting interface of outdoor unit; press SW1 (up) or SW2 (down) to select n5 function; when n5 is displayed, press SW7 to enter the functional setting; press the SW7 button again to complete the offset setting. For the main board with 4 buttons, press and hold SW1 button for more than 5 seconds to enter the functional setting interface of outdoor unit; press SW1 (up) or SW2 (down) to select n5 function; when n5 is displayed, short press SW3 to enter the functional setting; again Press the SW3 button to complete the offset setting.

3.2.4 Connection Method of L-CAC&Split Unit (Modbus Network)

The centralized controller has two ways to connect with the unitary system:

Method 1: The centralized controller connects the U-Match or PAC unit by the method as below.

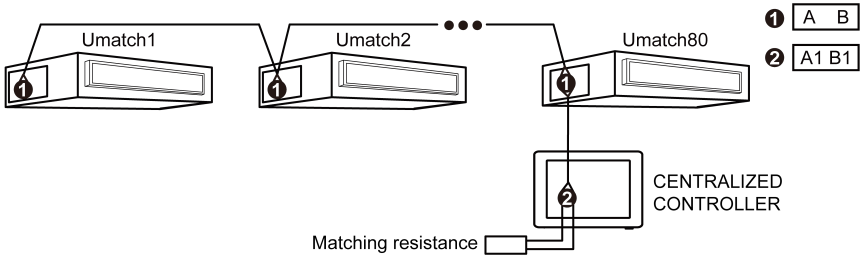

Fig. 3.7 Centralized controller connects to network of U-Match unit (with Modbus interface)

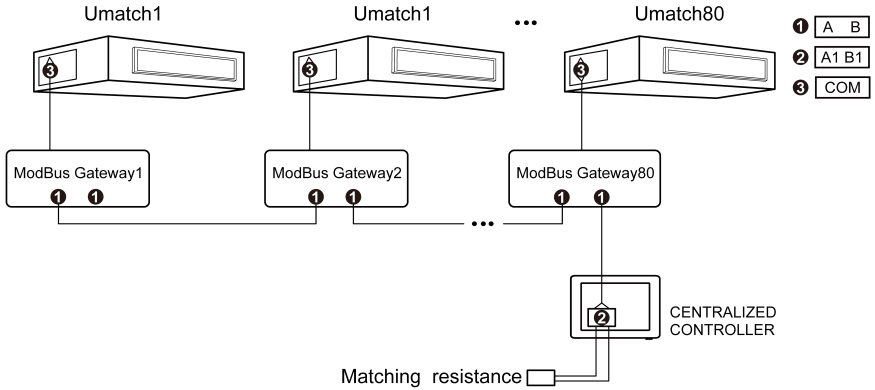

Fig. 3.8 Centralized controller connects to network of U-Match unit (needs to add Modbus gateway)

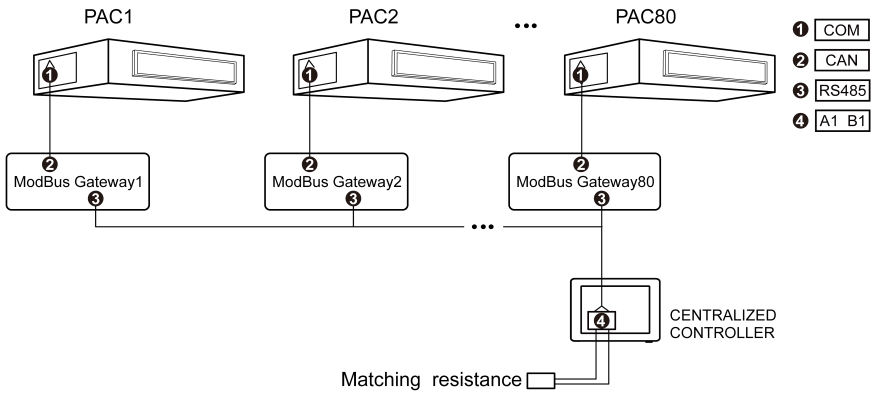

Fig. 3.9 Centralized controller connects to network of PAC unit

Wiring instructions:

- (1) The units controlled by one centralized controller should not exceed 80 sets.
- (2) When the centralized controller is connected to the U-Match unit network with COM_BMS(Modbus) interface, connect the network as shown in Fig. 3.7, otherwise connect the network as shown in Fig. 3.8. The A1 and B1 interfaces of the centralized controller and the unit/gateway A and B interfaces need to be connected one by one; when the centralized controller is connected to the PAC unit, connect to the network as shown in Fig. 3.9, the PAC unit is connected to the CAN interface of gateway through the COM interface, and the gateway RS485 interface is connected to the A1, B1 interfaces of centralized controller.
- (3) The centralized controller must be connected in series with the indoor unit of the last unit, and connected with matching resistors at the A1 and B1 interfaces together with the communication cable.
- (4) The gateways in Fig. 3.8 and 3.9 need to be purchased separately; and each indoor unit needs a gateway.
- (5) The address of indoor unit of the unit needs to be set in the range of 1-80, and cannot be the same, otherwise it will cause communication failure. The address settings are as follows:
 - ① Setting methods for indoor unit address of U-Match unit with 485 communication:
 - 1) In the off state, through the setting of wired controller, press the "Function" button and "Timer" button for 5 seconds to enter the remote monitoring setting, press the "MODE" button to select the "10" option, and then press "Up" and "Down" button to adjust, select 01 remote monitoring mode.
 - 2) In the power-off state, press the "Function" button and "Mode" button for 5 seconds to enter the address setting through the wired controller, and the temperature position of the display board will display the address number of the display board, and then press "Up" and "Down" button to adjust.
 - 3) After the setting is completed, press the "OK/Cancel" or "Swing/OK"

button to save and exit the setting. If the system responds to the last button input without any operation within 20 seconds after calling out this interface, the system will jump out of this menu and display the normal shutdown state interface, and the current settings will not be saved.

- ② Setting methods for address of U-Match unit with the zero line and live line communication:
- 1) On the power-on or power-off interface of the wired controller, press and hold the "FUNCTION " button for 5 seconds to display "C00", press the "MODE" button for 3 times (the interval between the buttons is within 1 second, when you press the " MODE" button, the first two prompts indicate that it is invalid operation, and the third time it will respond), continue to press the "FUNCTION" button for 5 seconds, enter the parameter setting interface, it displays "P00", and then press the "+" or "-" button to select the parameter code P42;
 - 2) When the wired controller controls one indoor unit, short press the " MODE" button to immediately enter the address setting state (when the wired controller controls multiple indoor units, enter the indoor unit selection menu, press the "+" or "-" button to switch the serial number of the indoor unit, the address number of indoor unit is displayed in the timer area, and the serial number of indoor unit is displayed in the temperature area by default, and then short press the " MODE" button to enter the address setting state);
 - 3) In the state of address setting, the timer area displays the address number of the indoor unit and flashes, press the "+" or "-" button to adjust the address number of the indoor unit, short press the "ENTER" button to confirm the setting and return to the previous state;
 - 4) After the setting is completed, press the "ON/OFF" button to exit the setting and return to the home page.

③ Setting methods for address of indoor unit of PAC unit:

Set the gateway address (corresponding to the address of the indoor unit) on the Modbus gateway of the PAC unit. The gateway address is set together through S1 and S2. The first digit of S3 must be dialed to the ON end of the gateway function code, otherwise it will not work normally with

the centralized controller for communication. See the gateway manual for detailed setting methods.

Method 2: The Centralized controller connects to the free match by the method as below:

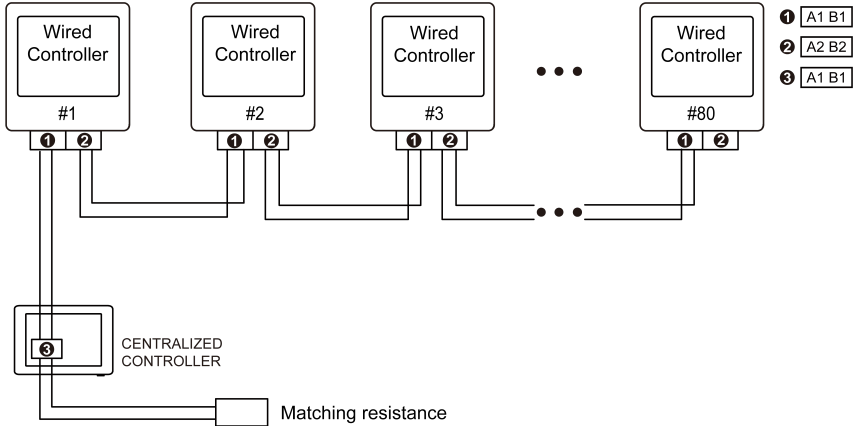

Fig.3.10 Centralized controller connected with wired controller of free match

Wiring Instructions:

- (1) The connection sketch map of control system is shown by the fig. 3.10. The complete control system is composed of long-distance central controller, wired controller and telecommunication cable. The wired controller matched with long-distance central controller can support 80 addresses of communication node at the most.

NOTE:

If the centralized controller is to be connected with Wired Controller , communication line (one end is two-core terminal, the other end is the bare wire. Code :420400060252) need to be purchased separately. The quantity of communication line is the quantity of Wired Controller plus 1.

- (2) Wiring terminals of port A1 and port B1 of the central controller or the long-distance controller connect to the corresponding terminal of communication needle stand of #1 wired controller through the telecommunication cable respectively; the other needle stand of #1 wired controller connects to the #2 wired controller through the telecommunication cable and so forth until connect to the #80 wired

controller. Except the last wired controller in the control system (only use CN3 or CN4, and the other one will not be connected), there's no the sequence and the importance for the wired controller. The series number in the figure is only for the sake of clarity.

- (3) There is a 2-bit DIP switch on the main board of wired controller .As for the last #80 wired controller in the control system, the 1-bit and the 2-bit of the DIP switch should be manually pulled to position "on" and position "off" respectively. The DIP switches of other wired controllers should be kept at the initial ex-factory status (1-bit and 2-bit are set at position "off").
- (4) As for the complete control system, the distance from the long-distance central controller to the communication cable of the last communication node should be less than 500m.

Notes:

- ① The indoor unit address and remote mode setting of the L-CAC&Split unit may be different for different wired controllers. For detailed methods, refer to the technical service manual of the corresponding unit.
- ② When replacing different types of L-CAC&Split units, it is necessary to restore the factory settings of the centralized controller and re-register to avoid control abnormalities.

3.3 Steps for Installation

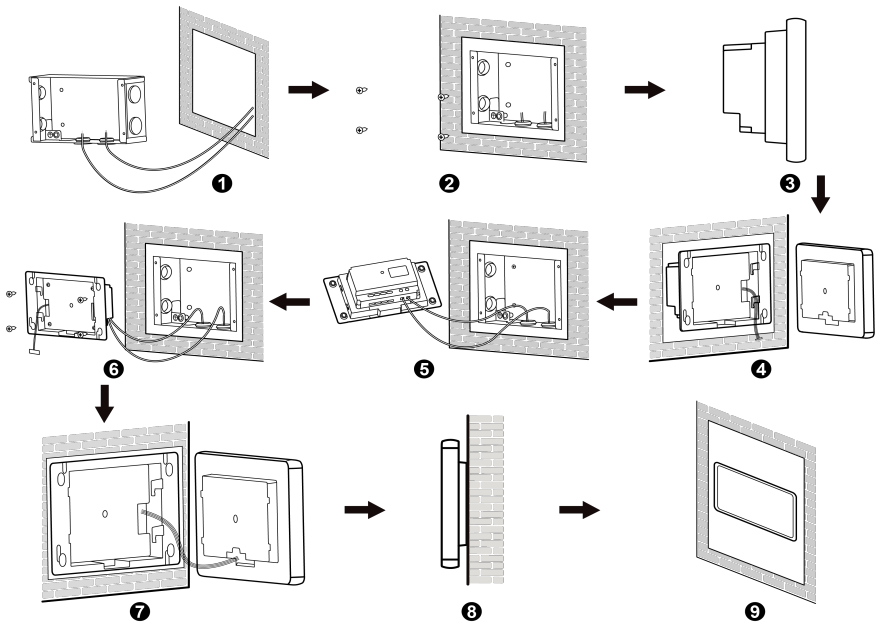

Fig. 3.11 Installation

Unit: mm

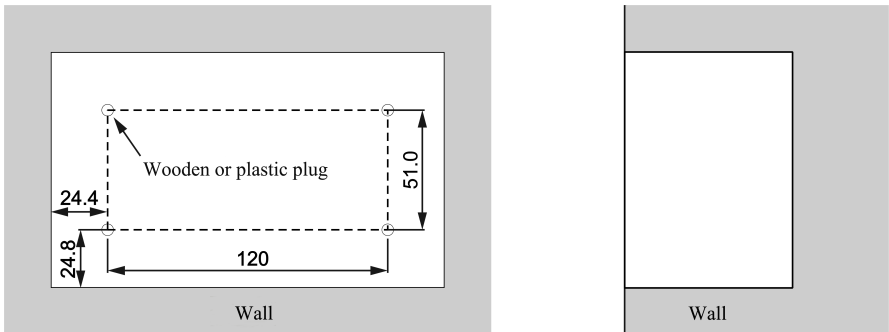

Fig. 3.12 Wooden wedge or plastic wedge

Unit: mm

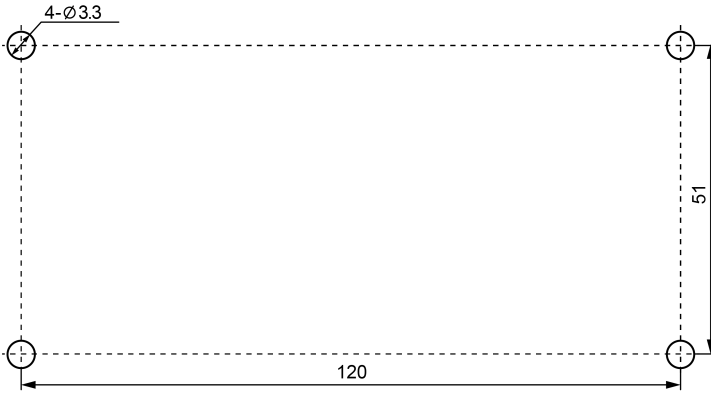



Fig. 3.13 Installation holes for rear cover of electric box

Figure 3.11 shows the simple installation process of the centralized controller.

The following issues need to be paid attention to:

- (1) Please cut off the power supply of the indoor unit before installation, and live operation is prohibited during the entire installation process.
- (2) During the installation process, handle with care and pay attention to protect the touch screen from damage.
- (3) Before installation, the following preparations need to be done:
 - 1) When the centralized controller is installed on the wall, dig a 168mm x 100mm x 52mm with length x width x depth installation hole on the wall, and nail 4 wooden wedges or plastic wedges at the positions shown in Figure 3.12.
 - 2) When the centralized controller is installed in the control cabinet, drill 4 installation holes on the wall of the control cabinet according to the position shown in Figure 3.13.
 - 3) In step①, pull out the power cord and communication cable, and pass through different wire holes on the back cover of the electric box respectively, and it is strictly forbidden to pass through the same wire hole.
 - (4) In step②, use ST4.2×16 FA screws to fix the rear cover of the electric box and the installation holes on the wall.

- (5) In step ③, pull out the connecting wire between the touch screen and the rear cover of the controller, and put the touch screen in a safe place.
- (6) In step ⑤, connect the communication cable to the G1 and G2 terminals, connect the zero and live wires of the power cord to the L and N terminals; connect the earth wire to the rear cover  of the electric box, and fix it with M4×12 screws.
- (7) In step ⑥, use ST3.9×9.5 PA screws to fix the rear cover of controller to the rear cover of electric box.
- (8) In step ⑦, plug the connecting wires between the touch screen and the rear cover of the controller together.

3.4 Steps for Disassembly

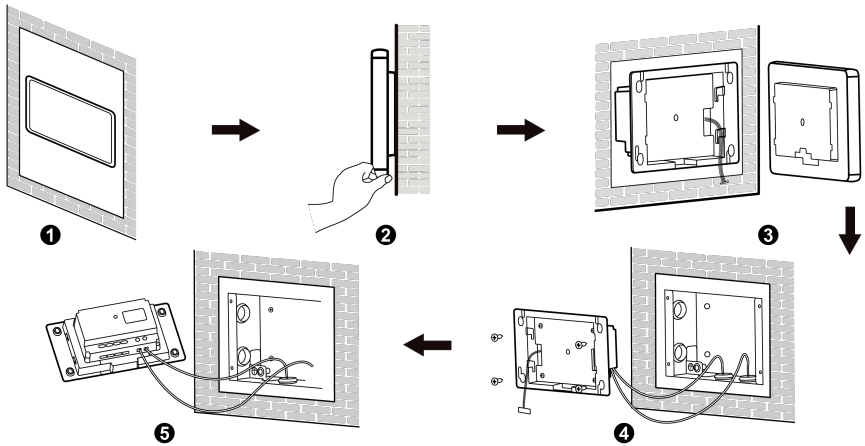



Fig. 3.14 Disassembly





4 Instruction for Display and Operation











Fig. 4.1 Home page

4.1 Main Page Display and Key Instructions

No.	Name	Instructions
1	Homepage status column	Left side displays current date and the middle part displays the current time. The right side displays WiFi, errors and other functional icons.
2	Menu column	It can check all devices and group devices; devices can be controlled by one button.
3	Group display area	The left side displays current groups; Air conditioner/hot water/ fresh air unit and other devices can be selected to display at the right side.
4	Device display column	All registered devices and their statuses will be displayed in card form. Click the card can enter into the control page of corresponding devices. When there are many devices, slide left and right to check the device card.
5	 button	Click it can magnify or shrink the device card.
6	Menu button	Click it to enter into menu page.
7	Batch control button	Click it to enter into batch control page.
8	All ON/OFF button	Click it can turn on or turn off all registered devices.

No.	Name	Instructions
9	Enter into notification page	Slide from the top of page can enter into the notification page.
10	Device selection button	Select the required device  Air conditioner  Hot water  Fresh air  Floor heating.
11	Indoor unit check	Input indoor unit name to search the indoor unit.
12	Indoor unit sequence	Click indoor units to rank it by name or engineering series no.

4.2 Instruction for Icons of General Buttons

Display	Name	Meaning	Display	Name	Meaning
	Return	Click to return to the previous page		New	Click to newly add schedule, timer, smart control and group, etc.
	ON/OFF	Click to turn on or turn off the unit		Close	Click to close the current pop-up window
	Switch	Click to turn on or turn off the function		Delete	Click to delete the group, operation or schedule
	Error inquiry	Click to enter error inquiry page		Shield	It can shield the related operations of wired controller to make its operation invalid

4.3 Instructions of Button Operation

The centralized controller screen adopts a capacitive touch screen, and the user operation interface is a full touch operation.

The buttons on the interface are mainly expressed in the following ways:

(1) Icon/Text

The icon button can be clicked to operate, see section 4.2 for details.

Text descriptions such as "edit", "finish" and other buttons can be clicked to operate.

(2) Icon + Text

According to the text prompt, turn on or turn off or select a certain function, or

enter a certain page. This type of button can have two or three state meanings, which represent different meanings according to specific functions.

The meaning of each state is as follows (take the shield button as an example):

 A lighter color indicates invalid/non-selectable. The shielding function is invalid and cannot be turned on, and it varies according to different models.

 A light color means off/not-selected. The shielding function is turned off, click to set to enable the shielding function.

 Blue means on/selected. The shielding function is enabled, click to set to disable the shielding function.

(3) Slide

Slide up and down/left and right. You can slide up and down or left and right in the area where the displayed content is too long.

(4) Slider

Press and hold the slider, drag up and down or left and right to adjust the value. Such as brightness, volume, temperature settings, etc.

(5) Area button

In the page list area, as shown in Figure 4.2 settings page and Figure 4.3 Smart Control page, the text description + underline indicates an area button.

Click the button in this area to enter the corresponding page for the next step.

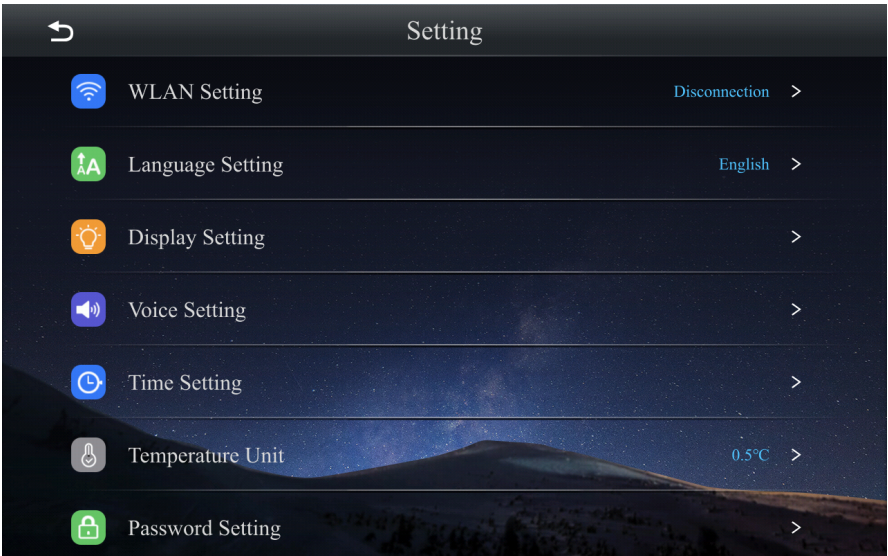

Fig. 4.2 Area button of setting page



Fig. 4.3 Area button of smart control page

5 Instruction for Functions

5.1 Notification Page

In the home page, slide from the top can enter notification page.

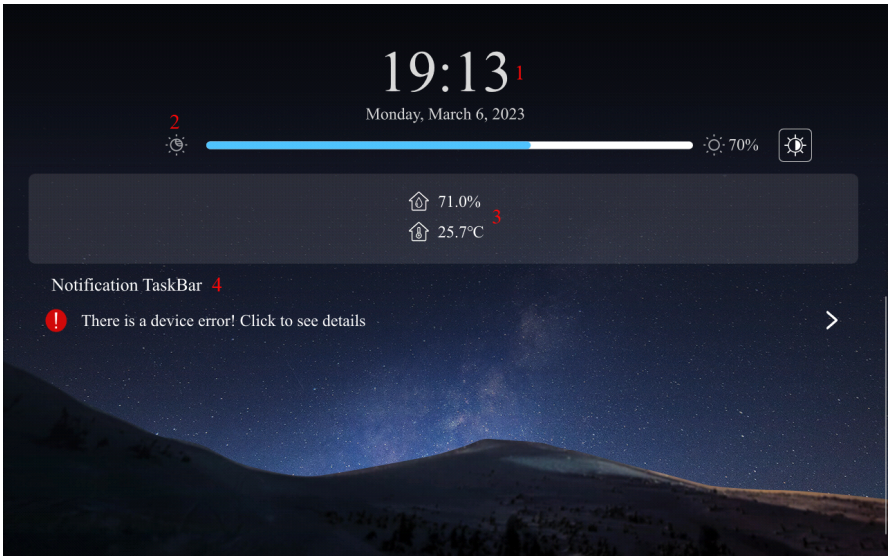

Fig. 5.1 Notification page

No.	Name	Instructions
1	Clock display area	Display current system time, date and week.
2	Brightness adjustment slider	Slide the slider to adjust the brightness, click the icon "☀️" to enable or disable the automatic brightness adjustment function.
3	Local environment information	Display the indoor temperature and humidity detected by the centralized controller.
4	Notification taskbar	Display notification information, error information, etc., click to enter the corresponding query interface.

5.2 Group

In the home page, click Group to enter the group page. You can group according to the geographical location in the menu-device management-group, which is convenient for group management of the devices in the corresponding location. After selecting a group, the master interface will display the devices under the group for easy management.

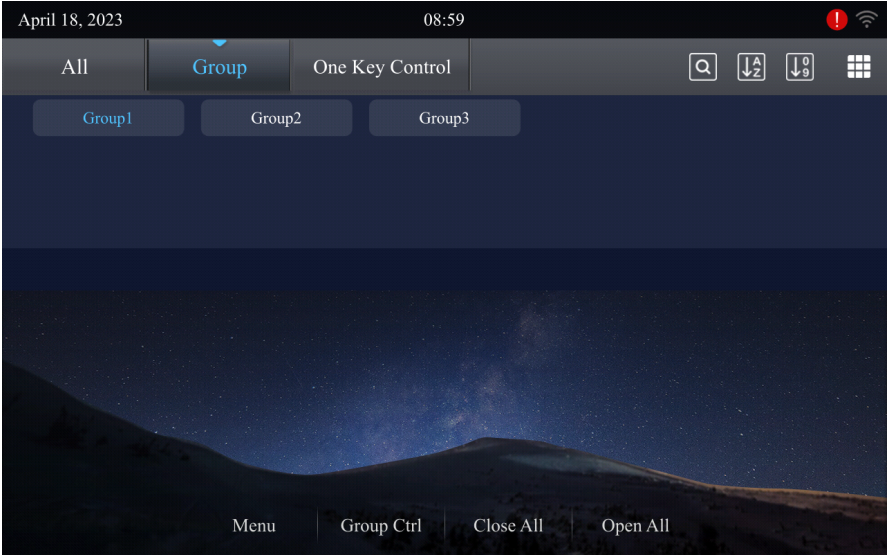

Fig. 5.2 Group page

5.3 One-button Control

In the home page, click one-button control to enter the page.

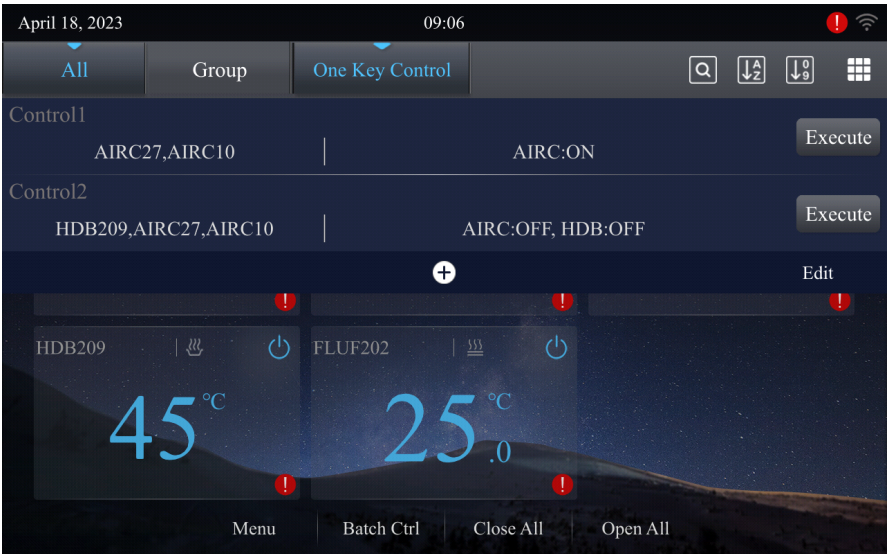



Fig. 5.3 One-button control page

- (1) Click  to create a new one-button control. After entering the name, you can add devices and set operations. After saving, you can view the relevant operation settings in the one-button control list.
- (2) Click the one-button control in the list to edit, modify equipment and set operations. Click the edit button in the lower right corner of the one-button control page to rename and delete the one-button control, and click Finish to save.
- (3) Click the Execute button to execute the corresponding one-button control instruction once.

5.4 Air Conditioner Control

On the home page or group page, click the air conditioner card to enter the air conditioner control page.



Fig. 5.4 Air conditioner control page

- (1) ON/OFF

Click the ON/OFF button to turn on or off the unit.

- (2) Mode setting

Click the mode area to switch the operating mode.

Different series of indoor units have different modes that can be set. When the

indoor unit does not have this mode, it cannot be switched to this mode.

Notes:

- ① Only the master indoor unit can set the automatic mode.
- ② The heat recovery system has no master indoor unit. When one indoor unit is connected to the same branch, the automatic mode can be set; when the number of indoor units under the same branch is more than one, the automatic mode cannot be set; other modes can be switched freely.

(1) Temperature setting

Slide the circular slider to adjust the set temperature value. When the button is clicked once, the temperature value will increase or decrease by 1 degree. Slide the slider to the right to increase the temperature value by 1 degree each time, and slide the slider to the left to decrease the temperature value by 1 degree each time. When 0.5°C is turned on, the temperature value will increase or decrease by 0.5°C. Click the "Environ PARM" button to query parameters such as indoor/outdoor ambient temperature, body temperature and humidity.

(2) Fan speed setting

Click the fan speed icon button to set a variety of different fan speeds.

Note: In the dehumidification mode, the fan speed defaults to low speed and cannot be set.

(3) Swing setting

Click the "LR Swing" or "UP Swing" area button to turn on or off the swing function.

Note: Different series of indoor units have different swing types that can be set.

(4) Other control settings

- 1) Click "Save" to enter the energy-saving setting interface, turn on the energy saving switch, click "Confirm" to save and enable the energy-saving setting.
- 2) The absent function can only be turned on in the heating mode. When the absent function is turned on, the set temperature will display 8°C.
- 3) Click "Shield" to enter the shield setting interface. When full shield is enabled, the rest of the shield buttons are invalid.
- 4) Click "Environ PARM" to check the current indoor and outdoor

temperature, indoor humidity, body temperature and humidity detected by the indoor unit.

(5) Viewing of error

When the indoor unit fails, a “!” error icon will appear, click the icon to view detailed error information.

5.5 Water Heating/Floor Heating Control

In the home page, click the water heating/floor heating device card to enter the water heating/floor heating control page, and click "Water" and "Floor" to switch the water heating/floor heating function.

5.5.1 Water Heating Control Page

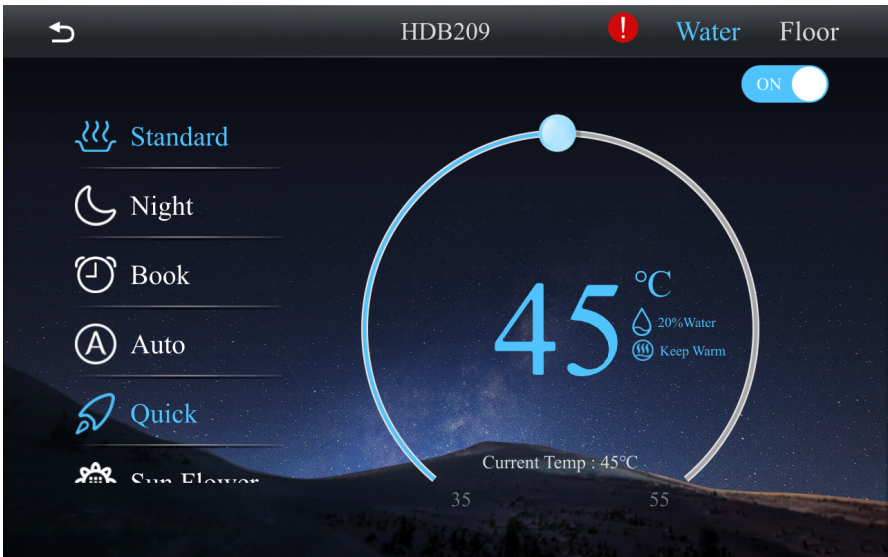

Fig. 5.5 Water heating control page

(1) ON/OFF

Click the ON/OFF button to turn on or off the unit.

(2) Mode setting

There are a total 3 modes: water heating, night, preset. The three modes are mutually exclusive, and only one of them can be selected.

Water heating mode: The water tank or hot water generator will immediately start or stop heating water according to the current set water temperature.

Night mode: The fixed hot water supply time is from 00:00 to 06:00. The water tank or hot water generator will be turned on during this time period, and the water tank or hot water generator will be turned on and off according to the difference between the set water temperature and the actual water temperature. After this time period, the water tank or hot water generator is switched off. They run in a daily cycle after startup.

Preset mode: Click to set the preset water heating time. The water tank or hot water generator will be turned on a certain period of time in advance according to the actual water temperature, and the start and stop of the water tank or hot water generator will be determined according to the difference between the actual water temperature and the set water temperature. The generator is turned off 1 to 4 hours after the scheduled time. They run in a daily cycle after startup.

(3) Temperature setting

It displays the current set temperature of hot water. You can slide the circular slider to adjust the set temperature value. When the button is clicked once, the temperature value will increase or decrease by 1 degree. Slide the slider to the right to increase the temperature value by 1 degree each time, and slide the slider to the left to decrease the temperature value by 1 degree each time. The lower rectangular area shows the current water temperature.

Under the standard water heating, preset water heating, and night water heating modes, the temperature setting range is: 35°C~the maximum hot water temperature 55°C.

(4) Available hot water

It can display the water volume in real time, with five levels of 100%, 80%, 60%, 40%, and 20%. When the water volume is less than 20%, the icon will flash to remind you.

(5) Functional setting of water heating

In the state of water heating function is on or off, the following functions can be set:

ON/OFF of water heater	Functions
Standard water heating when startup	Hot water temperature automatic setting, fast water heating, sunflower, hot water disinfection, hot water shielding
Night mode when startup	Hot water temperature automatic setting, fast water heating, hot water disinfection, hot water shielding

ON/OFF of water heater	Functions
Preset mode when startup	Hot water temperature automatic setting, fast water heating, hot water disinfection, hot water shielding
Water heater off	Hot water disinfection, hot water shielding

Hot water temperature automatic setting function: The set temperature of hot water temperature is automatically given by the water heater according to the outdoor ambient temperature, and does not need to be set by the user. At this time, the set temperature of hot water cannot be adjusted by sliding the circular slider.

Fast water heating function: Turn on the compressor and electric heater to heat water under the conditions allowed by the outdoor unit, and the fast water heating function is valid once set; when the water tank/hot water generator reaches the heat preservation state, the fast water heating function is canceled to save energy. After the water heater is turned off, the fast water heating function is canceled.

Sunflower function: By recording the historical data of the outdoor temperature, find out the highest outdoor temperature of the previous day to determine the time to turn on the water heater to achieve the purpose of energy saving.

Hot water disinfection function: Water temperature of the water tank is heated to 65~70°C (can be set) for high-temperature disinfection at the required setting time; click "  " to enter the disinfection setting, and the disinfection setting can be turned on after turning on the disinfection setting switch, and the disinfection setting "Once" or "Cycle". When it is valid once, you can set the disinfection temperature; when it is set cycle valid, you can set the disinfection temperature, cycle days and disinfection preset time; click the setting to save. When the disinfection function is turned on, the disinfection icon flashes and displays "Sterilizing".

Hot water shielding function: Click "  Water Shield" to shield the button operations of the related functions of the wired controller, making the operations invalid.

(6) View the error

When the water heater fails, a "  " error icon will appear. Click the icon to view detailed error information.

5.5.2 Floor Heating Control Page



Fig. 5.6 Floor heating control

(1) ON/OFF

Click the ON/OFF button to turn on or off the unit.

(2) Temperature setting

The temperature slider displays the currently set outlet water temperature. You can slide the circular slider to adjust the set temperature value. Slide the slider to the right to increase the temperature value by 1 degree each time, and slide the slider to the left to decrease the temperature value by 1 degree each time. The lower rectangular area shows the current water temperature.

Temperature setting range of floor heating outlet water: 25°C~45°C.

(3) Functional setting of floor heating

Automatic function: The set temperature of the floor heating outlet water is automatically given by the hot water generator according to the outdoor ambient temperature, and does not need to be set by the user. At this time, the set water temperature of the hot water cannot be adjusted by sliding the circular slider.

Fast floor heating function: Turn on the compressor and electric heater under the conditions allowed by the outdoor unit.

Floor heating absent function: When the user leaves, it can maintain a certain

water temperature to prevent pipelines from freezing and damage to indoor equipment.

Floor heating shielding function: Click "⊞ Floor Shield" to shield the button operations of the related functions of the wired controller, making the operations invalid.

- (4) View the error

When the floor heating fails, a "!" error icon will appear. Click the icon to view detailed error information.

5.6 Fresh Air Control

In the home page, click the fresh air equipment card to enter the fresh air control page.



Fig. 5.7 Fresh air control

- (1) ON/OFF

Click the ON/OFF button to turn on or off the unit.

When it is turned off, neither the mode nor the fan speed can be set, and the operating mode and fresh air inlet temperature are not displayed.

Note: The fresh air unit connected to the air box can display PM2.5, CO₂, indoor humidity and air quality level when it is turned on or off. When the air box is not

connected, PM2.5, CO₂, and indoor humidity will display "- -", and air quality level is hidden.

(2) Mode setting

Click the mode icon button to set the control mode.

Note: It can only be selected when the automatic mode is valid, and it cannot be selected when it is invalid.

(3) Fan speed setting

Click the fan speed icon button to switch between different fan speeds.

(4) View the error

When the fresh air function fails, a “!” error icon will appear. Click the icon to view detailed error information.

5.7 Floor Heating Adapter (Refrigerant Floor Heating) Control



Fig. 5.8 Floor heating adapter (refrigerant floor heating) page

(1) ON

Click the ON/OFF button to turn on or off the unit.

(2) Mode setting

The floor heating adapter only supports the floor heating mode, and cannot switch to other modes.

(3) Energy-saving

Floor heating energy-saving upper limit can be set.

(4) Temperature setting

Slide the circular slider to adjust the set temperature value. When the button is clicked once, the temperature value will increase or decrease by 1 degree. Slide the slider to the right to increase the temperature value by 1 degree each time, and slide the slider to the left to decrease the temperature value by 1 degree each time. When 0.5°C is turned on, the temperature value will increase or decrease by 0.5°C. Click the "Environ PARA" button to query parameters such as indoor/outdoor ambient temperature, body temperature and humidity.

(5) View the error

When the floor heating adapter fails, a “!” error icon will appear. Click the icon to view detailed error information.

5.8 Batch Control

In the home page, click the "Batch Ctrl" button in the lower left corner to enter the batch control function page.



Fig. 5.9 Batch control page

The batch control function can perform the following operations on the device registered air conditioner/water heating/fresh air/floor heating:

(1) Select device

First select the devices that need batch control, click “Confirm” to enter the batch control setting operation page; and click Cancel can exit the batch control setting page.

(2) Setting operation

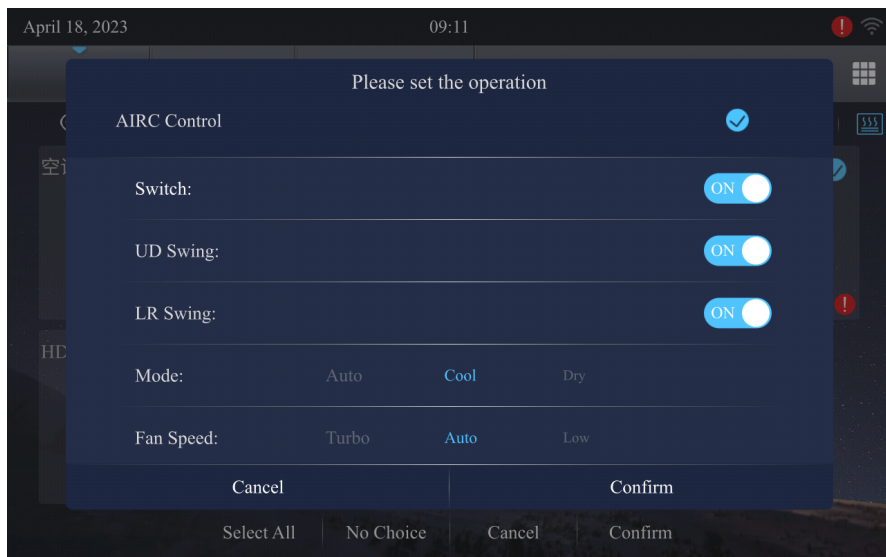

Fig. 5.10 Setting operation page

In the setting operation page, you can set the ON/OFF, up and down/left and right swing, mode, fan speed, temperature, etc. After clicking “Confirm”, you can perform batch control on the selected device according to the setting operation.

5.9 Function Page

In the home page, click the menu button to enter the home page of the function page.

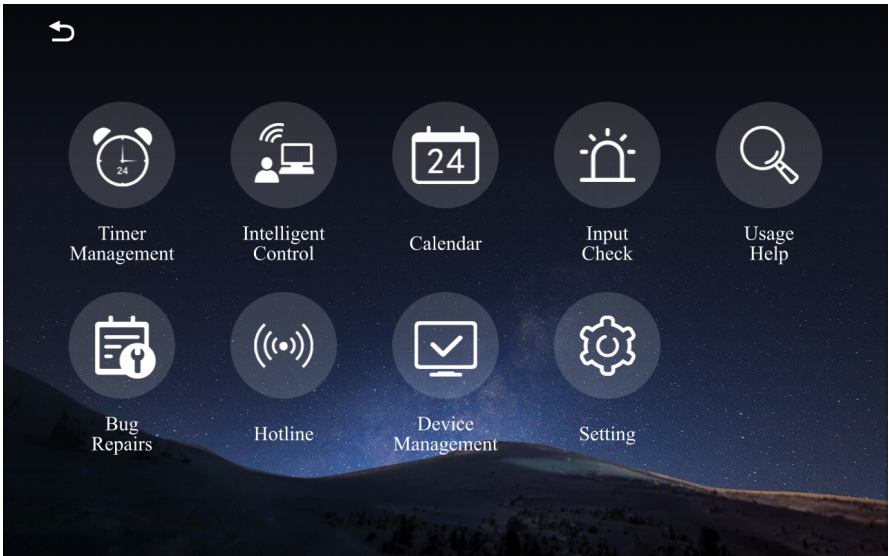

Fig. 5.11 Home page of functions

5.9.1 Timer Management

Click to enter the timer management page.

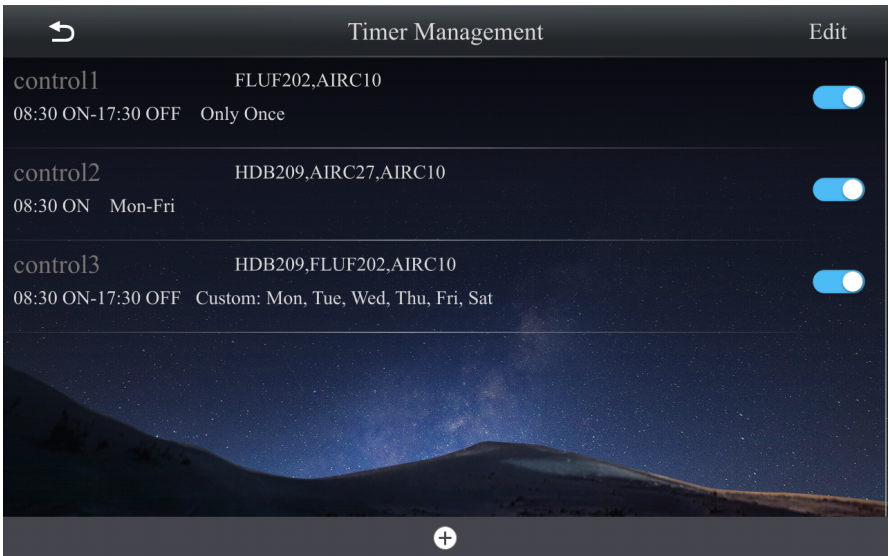

Fig. 5.12 Timer management page

- (1) Click the "+" button below, enter a name, and create a new timer management.

- (2) Follow the steps to set the timer, select the device, set the device operation, and click OK to save.
- (3) Click the "Edit" button in the upper right corner to modify the timer name and delete the timer management as needed, and click "Complete" to save.
- (4) Click the switch button on the right side of the timer management to turn on or off the timer management.
- (5) When the timer time is reached, the corresponding device will perform corresponding operations.

5.9.2 Intelligent Control

Click to enter the smart control page.



Fig. 5.13 Smart control page

- (1) Click the "+" button below, enter a name, and create a new intelligent control.
- (2) Follow the steps to set conditions, select devices, set device operations, and click "Confirm" to save.
- (3) When all the conditions or any of the conditions are met, the corresponding device will execute the corresponding operation once.

Every time the condition changes from unsatisfied to satisfied, it will be executed once.

- (4) Click the switch button on the right side of the smart control to turn on or off the smart control.
- (5) Click the "Edit" button in the upper right corner to modify the timer name and delete the timer management as needed, and click Finish to save.

5.9.3 Calendar

Click to enter the calendar page.



Fig. 5.14 Calendar

- (1) Click the "+" button at the bottom right, enter a name, and create a new schedule.
- (2) You can select the event start time, end time, select equipment and set operations, click "Confirm" to save.
- (3) After the creation is completed, a "blue dot" mark will appear in the calendar, click to view the schedule set under the date.
- (4) Click the switch button on the right side of the schedule to open or close the calendar.

- (5) Click on the schedule list to enter the modification schedule, and click the "Edit" button in the upper right corner to modify the schedule name and delete the schedule.

5.9.4 Input Detection

Click to enter the input detection page, you can turn on the fire alarm (valid for connected or valid for disconnected), I/O input detection (rising edge detection or falling edge detection) functions to increase equipment security.



Fig. 5.15 Fire alarm page

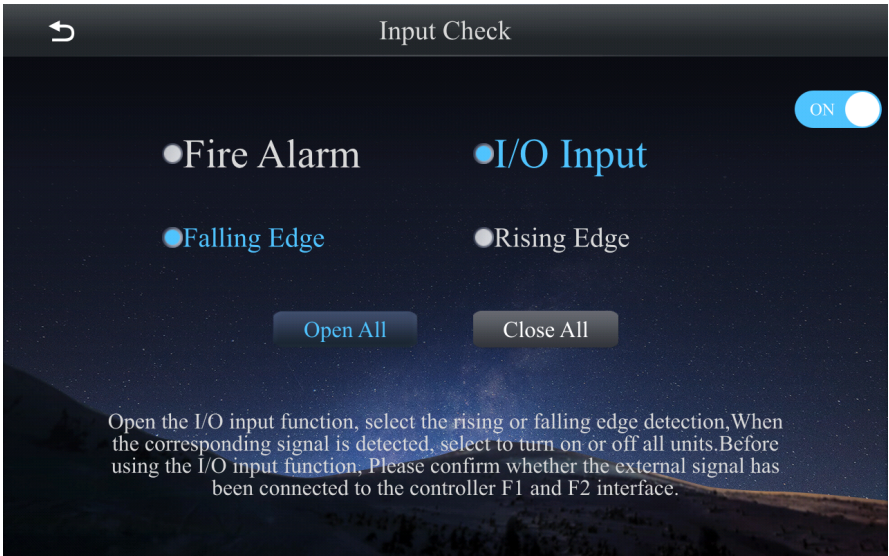

Fig. 5.16 IO input page

- (1) Connect the centralized controller to the fire alarm detection unit, select and turn on the fire alarm function, and select whether the detection unit is valid for connected or valid for disconnected. When a fire alarm is detected, the centralized controller will automatically shut down all the units.
- (2) Select the IO input function, you can choose the rising edge or falling edge detection, fully closed or fully open of the unit. When the response signal is detected, the centralized controller will control the unit to be fully opened or fully closed.

5.9.5 User Help

Click to enter the user help page, and you can view the help information for centralized controller operation on the user help interface.

5.9.6 Device Management

Click to enter the device management page.



Fig. 5.17 Device management page

The device management page can perform the following operations on the device registered air conditioner/water heating/fresh air/floor heating:

(1) Register the device

Click the "Register" button in the lower left corner to enter the device registration interface, select the device to be registered, and click the "Confirm" button in the lower right corner of the page to complete the device registration. Registered devices don't show up on the device registration page.

(2) Delete the device

Select the device to be deleted, click the "Delete" button at the bottom of the page to delete the selected device. Click Finish to save and exit the device management page.

(3) Rename

Device card can be renamed.

(4) Device management - Grouping

In the group page, you can click the "+" at the bottom to add a group, click "Edit" to modify the group name or delete the group, and click "Add Device" or "Delete" at the bottom of the page to add the required device or delete the device for the selected group. Click Finish to exit the device management page.

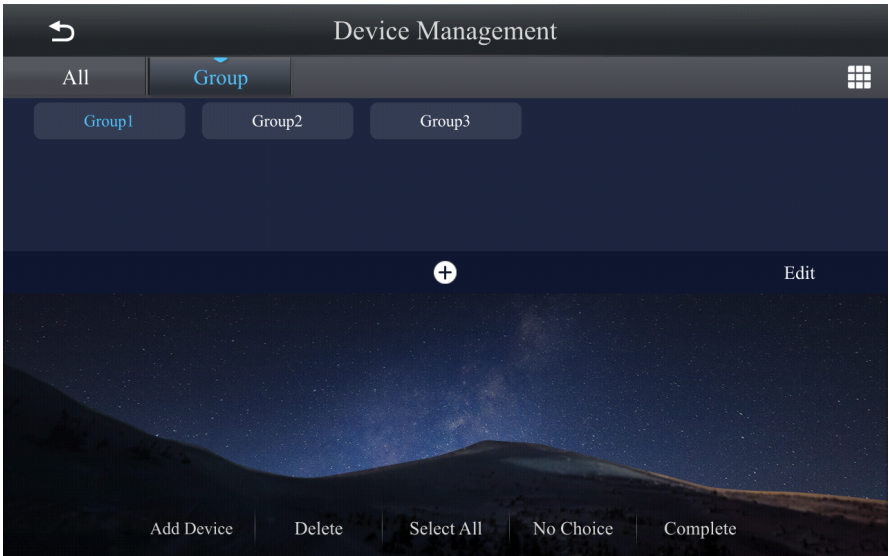

Fig. 5.18 Device management --grouping

5.9.7 Error Report and Repair

Click to view the current error information.

5.9.8 Service Hotline

Click to enter to view the saved local service hotlines and outlets, so that you can obtain consulting answers and technical services in a timely and efficient manner.

5.9.9 Settings

Click to enter the home page of the settings page, you can perform relevant setting operations.

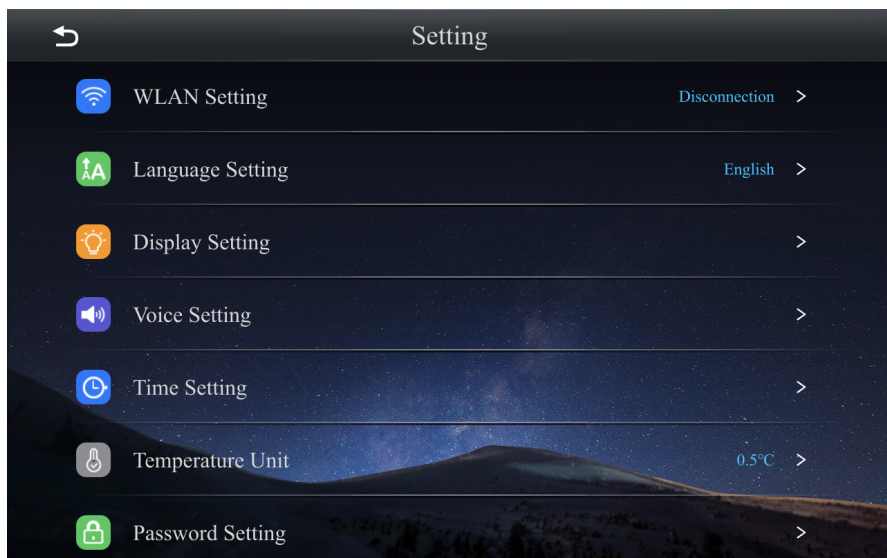

Fig. 5.19 Setting page

(1) WiFi setting

Click to enter the WiFi setting page, you can turn the WiFi function on or off, select available WiFi and enter the correct password to connect to the network.

(2) Language setting

Click to enter the language setting page to switch between different languages.

(3) Display setting

Click to enter the display setting page to set the brightness, screensaver wallpaper, lock time, and turn on/off standby screensaver.

(4) Sound setting

Click to enter the sound setting page to set the mute mode, volume and button tone type.

(5) Time setting

Click to enter the time setting page to set the time format, automatically obtain the time (network connection is required), manually set the time, and synchronously set the unit time.

(6) Temperature unit setting

Click to enter the temperature unit setting page to select Celsius unit or Fahrenheit unit, where the 0.5 degree function is only effective in degrees Celsius. When the 0.5 degree function is turned on, the temperature increases or decreases

in 0.5 degree.

(7) Password setting

Click to enter the password setting page to add or modify the administrator password and user password (lock screen password), of which the administrator password is used for factory reset and other permissions, and the user password is used for the lock screen password.

(8) Service hotline setting

Click to enter the service hotline setting page to input the service hotline and service outlets, and then you can save it after exiting, and then you can view the corresponding input information on the function page - service hotline page.

(9) APP control

Click to enter the APP control page will generate a control QR code, and remote control can be carried out after scanning the code through the APP on the mobile phone.

(10) Other settings

Click to enter the other settings page to view the error information of the indoor and outdoor units.

(11) Factory reset

After clicking to enter the factory reset page and entering the correct administrator password, you can perform a factory reset to restore the parameters to the default values.

(12) System updates

Click to enter the system update page, you can check the new system after networking. When there is a new system, you can perform the system update.

(13) About the unit

On this page, you can view the current program version and firmware version of the centralized controller.

6 Packing List

No.	Name	QTY	Remarks
1	Centralized controller	1 set	
2	Rubber ring	6 pieces	
3	Tapping scre	4 pieces	ST4.2×16 FA
4	Tapping screw	4 pieces	ST3.9×9.5 PA
5	screw	1 piece	M4×12
6	Matched resostor	2 pieces	
7	User manual	1 piece	
8	certification	1 piece	
9	Electric box	1 piece	

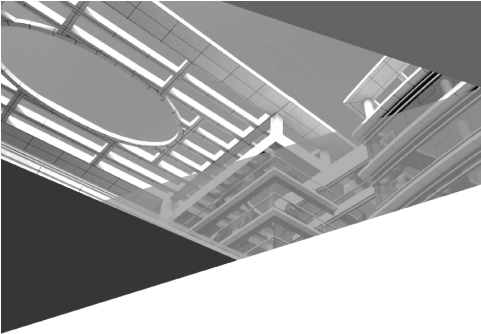

GREE ELECTRIC APPLIANCES, INC. OF ZHUHAI

Add: West Jinji Rd, Qianshan, Zhuhai, Guangdong, China, 519070

Tel: (+86-756) 8522218

Fax: (+86-756) 8669426

E-mail: global@cn.gree.com www.gree.com



600005064315