



Owner's Manual

Original Instructions
Commercial Air Conditioners

Wired Controller XK49

Thank you for choosing commercial air conditioners. Please read this Owner's Manual carefully before operation and retain it for future reference.

If you have lost the Owner's Manual, please contact the local agent or visit www.gree.com or send an email to global@gree.com.cn for the electronic version.

GREE ELECTRIC APPLIANCES, INC. OF ZHUHAI

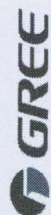

GREE ELECTRIC APPLIANCES, INC. OF ZHUHAI

Add: West Jinji Rd, Qianshan, Zhuhai, Guangdong, China, 519070
Tel: (+86-756) 8522218
Fax: (+86-756) 8669426
E-mail: gree@gree.com.cn www.gree.com

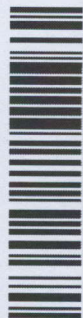

66175200017

To Users

Thank you for selecting Gree's product. Please read this instruction manual carefully before installing and using the product, so as to master and correctly use the product. In order to guide you to correctly install and use our product and achieve expected operating effect, we hereby instructed as below:

- (1) This appliance is not intended for use by persons (including children) with reduced physical, sensory or mental capabilities, or lack of experience and knowledge, unless they have been given supervision or instruction concerning use of the appliance by a person responsible for their safety. Children should be supervised to ensure that they do not play with the appliance.
- (2) This instruction manual is a universal manual, some functions are only applicable to particular product. All the illustrations and information in the instruction manual are only for reference, and control interface should be subject to actual operation.
- (3) In order to make the product better, we will continuously conduct improvement and innovation. We have the right to make necessary revision to the product from time to time due to the reason of sales or production, and reserve the right to revise the contents without further notice.
- (4) For personal injury or property loss and damage caused

by improper operation such as improper installation and debugging, unnecessary maintenance, violation of related national laws and rules and industrial standard, and violation of this instruction manual, etc., we will bear no liability.

(5) **The final right to interpret for this instruction manual belongs to Gree Electric Appliances Inc. of Zhuhai.**

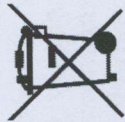

This marking indicates that this product should not be disposed with other household wastes throughout the EU. To prevent possible harm to the environment or human health from uncontrolled waste disposal, recycle it responsibly to promote the sustainable reuse of

material resources. To return your used device, please use the return and collection systems or contact the retailer where the product was purchased. They can take this product for environmental safe recycling.

Contents

1. SAFETY NOTICES (PLEASE BE SURE TO ABIDE)	1
2. OPERATION NOTICES	2
3. DISPLAY	3
3.1 LCD OF WIRED CONTROLLER	4
3.2 LCD DISPLAY INSTRUCTION	4
4. BUTTONS	6
4.1 BUTTON GRAPHICS	6
4.2 FUNCTION INSTRUCTION OF BUTTONS	7
5. INSTALLATION AND COMMISSIONING	8
5.1 INSTALLATION OF WIRED CONTROLLER	9
5.2 COMMISSIONING	21
6. OPERATION INSTRUCTIONS	31
6.1 ON/OFF	31
6.2 MODE SETTING	32
6.3 TEMPERATURE SETTING	32
6.4 FAN SETTING	34
6.5 SWING SETTING	34
6.6 REMOTE SHIELD FUNCTION	34
6.7 CHILD LOCK FUNCTION	35
6.8 GATE-CONTROL FUNCTION	35
7. ERROR DISPLAY	36
7.1 TABLE OF ERROR CODES FOR OUTDOOR UNIT	37
7.2 TABLE OF ERROR CODES FOR INDOOR UNIT	39
7.3 TABLE OF STATUS CODES	40
7.4 TABLE OF DEBUGGING CODES	41

1 SAFETY NOTICES (PLEASE BE SURE TO ABIDE)



Warning: If not abide strictly, it may cause severe damage to the unit or the people.



Note: If not abide strictly, it may cause slight or medium damage to the unit or the people.



This sign indicates that the operation must be prohibited. Improper operation may cause severe damage or death to people.



This sign indicates that the items must be observed. Improper operation may cause damage to people or property.



WARNING!

This product can't be installed at corrosive , inflammable or explosive environment or the place with special requirements, such as kitchen. Otherwise, it will affect the normal operation or shorten the service life of the unit, or even cause fire hazard or serious injury. As for above special places, please adopt special air conditioner with anti-corrosive or anti-explosion function .

2 OPERATION NOTICES

- ◆ The power supply for all indoor units must be unified.
- ◆ Prohibit installing the wired controller at wet or sunshine places.
- ◆ Do not knock, throw or frequently disassemble the wired controller.
- ◆ Do not operate the wired controller with wet hands.
- ◆ In one system network, you must set one indoor unit as the master indoor unit, Other indoor units are slave indoor units.
- ◆ The operation mode of the system is basing on that of master indoor unit. Master indoor unit can switch to any modes, while slave unit can't switch to the mode that is conflicting with master indoor unit.
- ◆ When master indoor unit changes mode which cause operation mode of slave indoor unit conflicts with that of system, the operation mode of slave unit will switch to the operate mode of system automatically.
- ◆ When two wired controllers control one (or more) indoor unit(s), the address of wired controller should be different.
- ◆ This wired controller should be set as slave controller when it is used to control one (multiple) indoor unit (s) with other types of wired controller (s).
- ◆ This wired controller is equipped with gate control interface, which can be connected with gate control system to switch unit on/off by inserting or removing a card.
- ◆ Functions with "*" are optional for indoor units. If a function is not included in an indoor unit, wired controller can't set the function, or setting of this function is invalid to the indoor unit.

3 DISPLAY



Fig. 3.1 Appearance of wired controller

3.1 LCD of Wired Controller

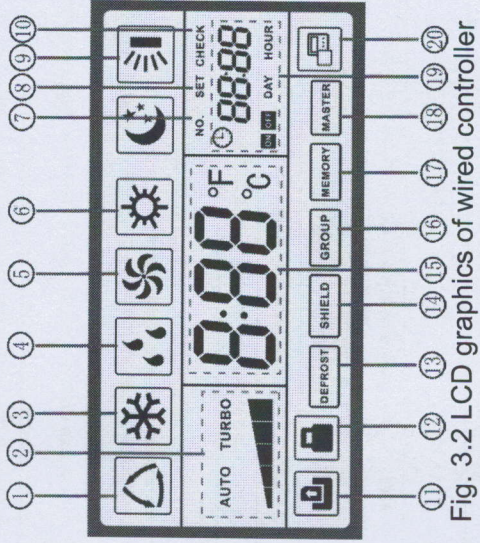

Fig. 3.2 LCD graphics of wired controller

3.2 LCD Display Instruction

Table 3.1 LCD display instruction

No.	Symbols	Instructions
1		Auto mode (Under Auto mode, the indoor units will automatically select their operating mode as per the temperature change so as to make the ambient comfortable.)
2		Current set fan speed (including auto, low speed, medium-low speed, medium speed, medium-high speed, high speed and turbo seven status)

No.	Symbols	Instructions
3		Cooling mode
4		Dry mode
5		Fan mode
6		Heating mode
7	NO.	When inquiring or setting project number of indoor unit, it displays "NO." icon
8	SET	Display "SET" icon under parameter setting interface
9		Up and down swing function
10	CHECK	Display "CHECK" icon under parameter view interface
11		Gate-control function
12		Child Lock status
13	DEFROST	Outdoor unit defrosting status
14	SHIELD	Shielding status
15		It shows the setting temperature value (in case the wired controller is controlling a Fresh Air Indoor Unit, then the temperature zone will display FAP)
16	GROUP	One wired controller controls multiple indoor units
17	MEMORY	Memory status (The indoor unit resumes the original setting state after power failure and then power recovery)

No.	Symbols	Instructions
18	MASTER	Current wired controller connects master indoor unit
19		The data display area will help to show the parameters checked or set
20		It indicates the current wired controller is the slave wired controller (address of wired controller is 02)

4 BUTTONS

4.1 Button Graphics

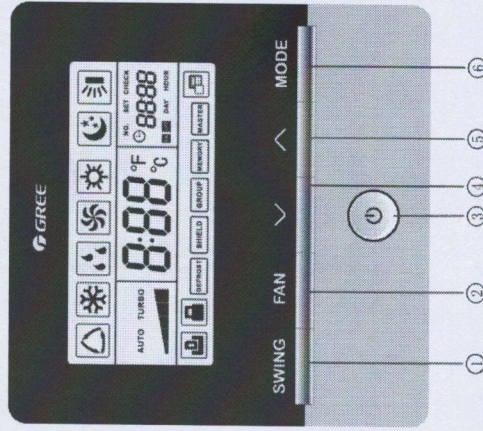

Fig. 4.1 Button graphics

4.2 Function Instruction of Buttons

Table 3.1 Function instruction of buttons

No.	Buttons	Instructions
1	SWING	It's used to set swing status.
2	FAN	Switch among auto, low speed, low-medium speed, medium speed, medium-high speed, high speed and turbo status
3	ON/OFF	Indoor unit On/Off
4	∨	(1) Set operating temperature of indoor unit
5	∧	(2) Set and inquiry parameter
6	MODE	Switch Auto, Cooling, Dry, Fan, Heating modes for indoor unit. (Note: The Floor Heating, 3D Heating and Space Heating function icon will show up when the unit has those functions.)
4+5	∧+	Simultaneously press "∧" and "∧+" for 5s to enter or cancel the Child Lock function.

5 INSTALLATION AND COMMISSIONING

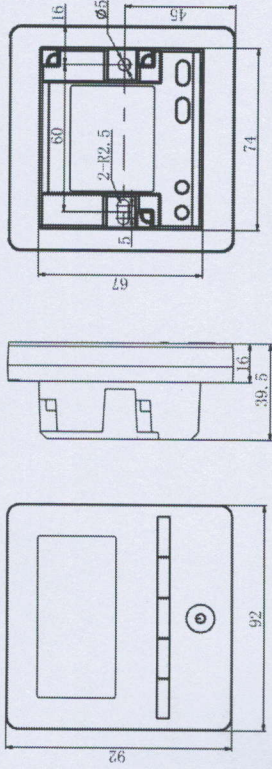

Fig. 5.1 Dimension of wired controller

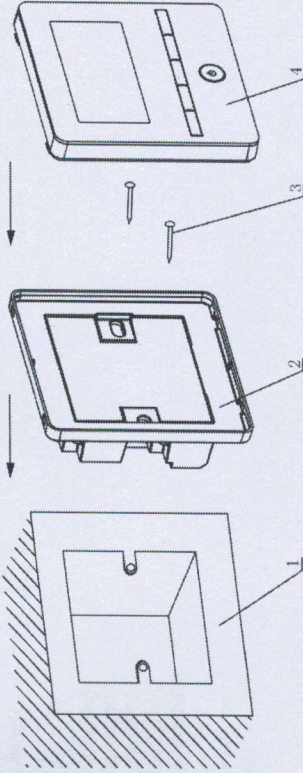

Fig. 5.2 Parts of wired controller

No.	1	2	3	4
Name	Junction box embedded in the wall	Soleplate of wired controller	Screw M4*25	Panel of wired controller
Qty	User-supplied	1	2	1

5.1 Installation of Wired Controller

5.1.1 Communication Line Selection

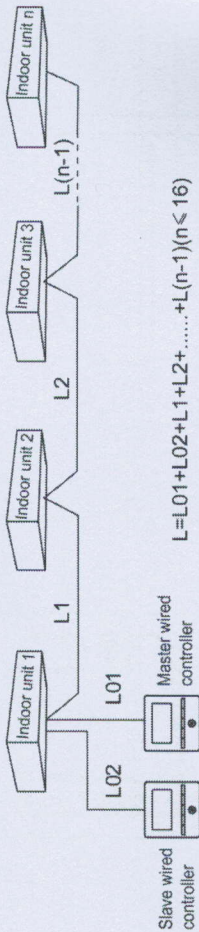

Fig. 5.3 Length of communication line

Wire material type	Total length of communication line between indoor unit and wired controller L (m/feet)	Wire size (mm ² /AWG)	Material standard	Remarks
Light/Ordinary polyvinyl chloride sheathed cord. (60227 IEC 52 /60227 IEC 53)	$L \leq 250m$ ($L \leq 820-1/5feet$)	2×0.75 $mm^2 \sim 2 \times 1.25$ mm^2 ($2 \times AWG18 \sim 2 \times AWG16$)	IEC 60227-5	① Total length of communication line can't exceed 250m (820-1/5feet). ② The cord shall be Circular cord (the cores shall be twisted together). ③ If unit is installed in places with intense magnetic field or strong interference, it is necessary to use shielded wire.

! Note

- ① If the air conditioner is installed at the strong electromagnetic interference place, communication line of the wired controller must use shielding twisted pair.
- ② Materials of communication line for wired controller must be selected according to this instruction manual strictly.

5.1.2 Installation requirements

- (1) Prohibit installing the wired controller at wet places.
- (2) Prohibit installing the wired controller at direct sunshine places.
- (3) Prohibit installing the wired controller at the place near high temperature objects or water-splashing places.
- (4) Prohibit installing the wired controller at the place where faces forward to the window. Prevent abnormal work due to the interference from the other wired controller around.

5.1.3 Wiring Requirements

5.1.3.1 Wiring between wired controller and indoor network

There are four network wiring methods between wired controller and indoor unit:

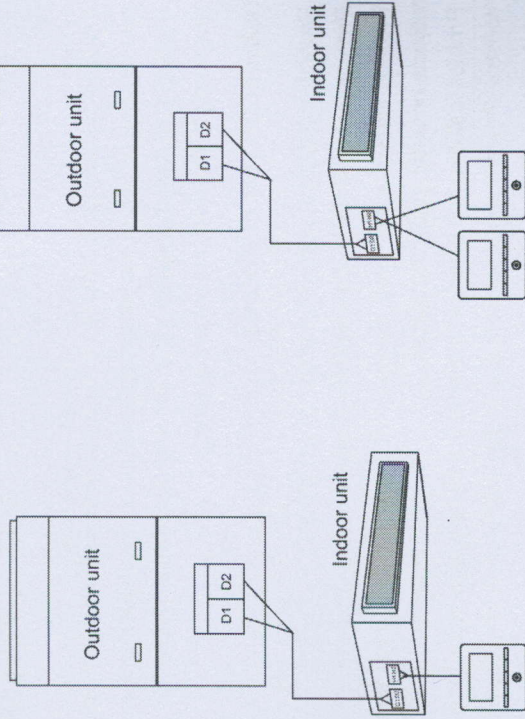

Fig. 5.4 One wired controller controls one indoor unit

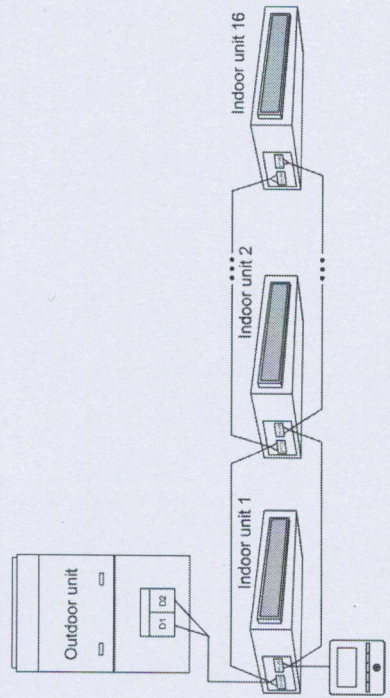

Fig. 5.6 One wired controller controls multiple indoor units simultaneously

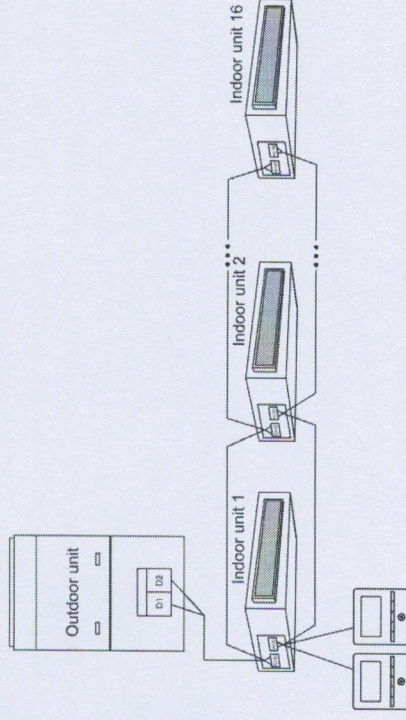

Fig. 5.7 Two wired controllers control multiple indoor units simultaneously

Wiring instructions:

- (1) When one wired controller controls multiple indoor units simultaneously, the wired controller can connect to any one indoor unit, but the connected indoor unit must be the same series indoor unit. The total quantity of indoor unit controlled by wired controller can't exceed 16 sets, and the connected indoor unit must be within the same indoor unit's network. Wire controller must set quantity of group control indoor units. Please refer to 5.2.3 Parameters Setting.
- (2) When two wired controllers control one indoor unit, the addresses of those two wired controllers should be different. Please refer to 5.2.3 parameter setting.
- (3) When two wired controllers control multiple indoor units, wired controller can connect to any one indoor unit, while the connected indoor unit should be the same series indoor unit. The addresses of those two wired controllers should be different. Please refer to 5.2.3 parameter setting. The total quantity of indoor unit controlled by wired controller can't be more than 16 sets and all connected indoor units must be within the same indoor unit network. Wire controller must set quantity of group control indoor units. Please refer to 5.2.3 Parameters Setting.
- (4) When one (or two) wired controller(s) control(s) multiple indoor units at the same time, the controlled indoor unit's setting should be the same.
- (5) Wiring of wired controller and indoor unit network must be according to one of the four wiring method as shown in fig 5.4-5.7. As for the connection method shown in fig 5.5 and 5.7, there should be only one master wired controller (address is 01) and one slave wired controller (address 02). The quantity of wired controller can't exceed two.

**Note**

Series of indoor units include: ① Common Multi VRF Units; ② Fresh Air Units; ③ Double-heat Sources Units; ④ Combined Units; Except for fresh air units, double-heat sources units and combined units, the rest of indoor units belong to common multi VRF units.

5.1.3.2 Wiring between wired controller and gate control system

This model wired controller has gate control interface, which can be connected with gate control system to switch unit on/off by inserting or removing a card. If you want to control indoor unit's functions through gate control, please pay attention to the wire connection between wired controller and gate control system (gate-control device):

- (1) Never connect the power cord of outdoor or indoor units directly to the gate-control device in order to realize gate control function by connecting or disconnecting power of indoor and outdoor units with a card. The following two figures demonstrate the wrong connection of wires between units and gate control system:

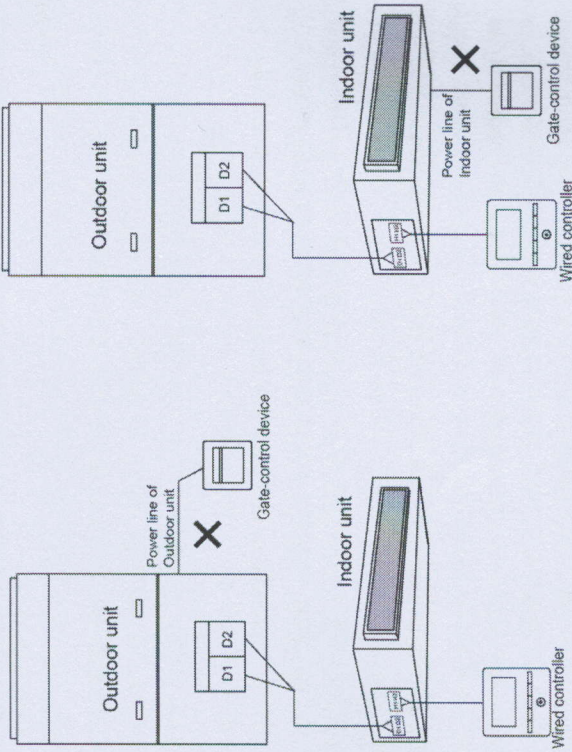

Figure 5.8 Wrong Connection 1

of Units and Gate Control

(2) After wired controller is connected with gate-control device, indoor unit's on and off can be controlled with a card: remove the card to turn unit off; insert the card to restore unit to the condition prior to card removal. The gate control card can control all indoor units that are linked with the wired controller.

Connection of wired controller and gate control system is as follow:

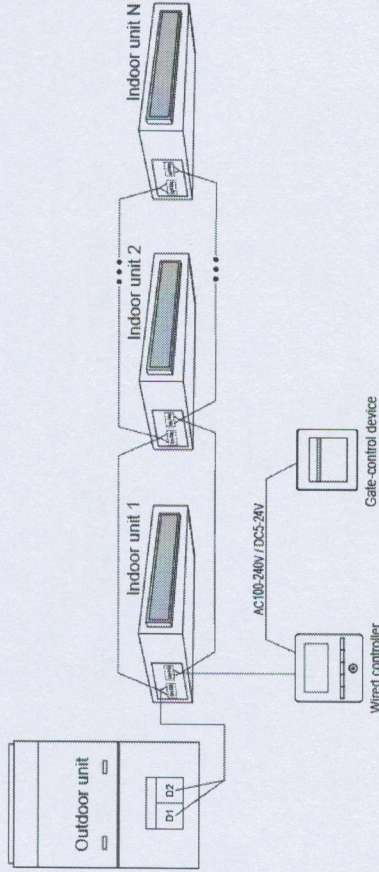

Figure 5.10 Connection fashion 1 of Wired Controller and Gate Control

(3) If two wired controllers are controlling one (or more) indoor unit(s), just connect one wired controller with the gate control system to control indoor unit's ON and OFF via the gate control card. As the following figures:

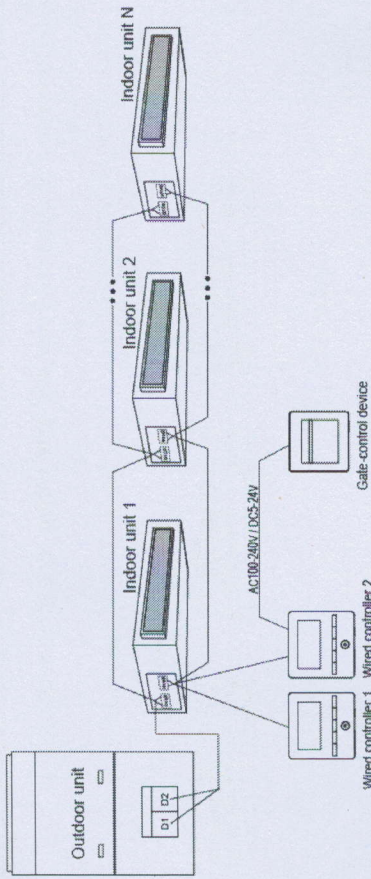

Figure 5.11 Connection fashion 2 of Wired Controller and Gate Control



Note

- ① Wired controller 2 in figure 5.11 can be set as master controller or slave controller;
- ② Wired controller 1 in figure 5.11 can be model XK49 or other models.
- (4) Power input of gate control card insertion/removal device supported by wired controller: AC 100-240V~50/60Hz, DC 5~24V. In practice, connect the gate control output power cord with the corresponding power supply interface of wired controller according to the type of output power of gate-control device (Please refer to 5.1.4 Installation for wire connection of specific interface). Wired controller will judge the placing and absence of card by detecting the power supply of gate-control device. The detecting process is as follow:

- (5) Inserting or removing the gate control card is like connecting or disconnecting power of the gate control device. When the card is inserted, the device supplies power AC100-240V/DC5-24V to wired controller which identifies card insertion. When the card is removed, the device stops supplying power AC100-240V/DC5-24V to wired controller which identifies card removal. Figure 5.12 and figure 5.13 demonstrate wired controller connecting gate control power of AC100-240V or DC5-24V:

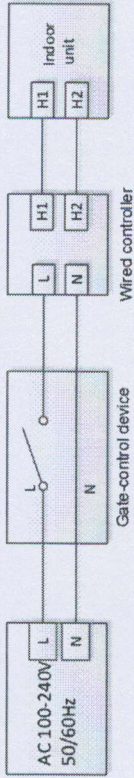

Figure 5.12 Wired Controller Connecting to Gate Control AC100-240V

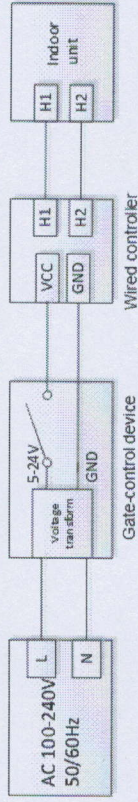

Figure 5.13 Wired Controller Connecting to Gate Control DC5-24V

Note: Users shall prepare the gate-control device by themselves.

5.1.4 Installation

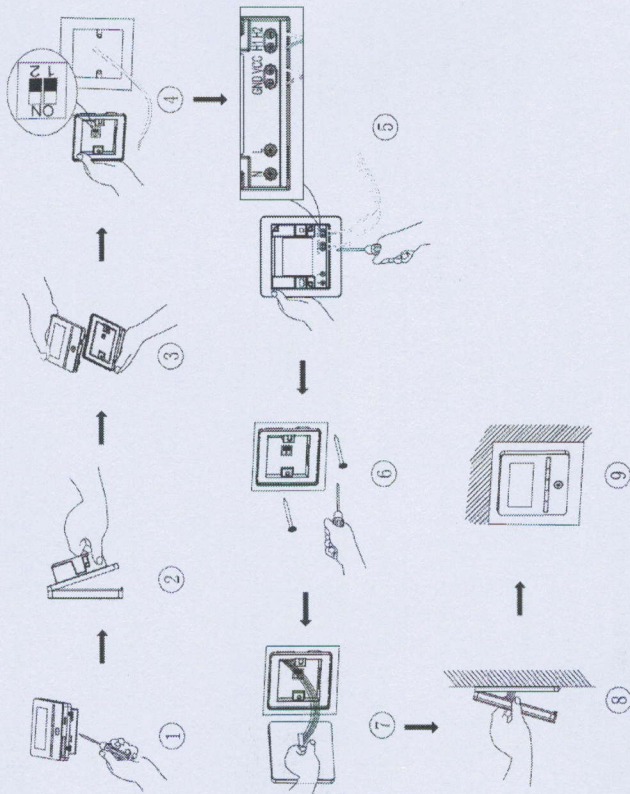

Fig. 5.14 Installation diagram for wired controller

Fig. 5.14 is the simple installation process of wired controller; please pay attention to the following items:

- (1) Before installation, please cut off the power for indoor unit.
- (2) Pull out the 2-core twisted pair line connected with the indoor unit from the mounting hole and separately fix the twisted pair on the H1 and H2 terminal by screws.
- (3) Gate-control wiring notice:
 - a) If the gate-control system is not involved, turn the No.1 switch of the DIP switch S1 to the number side which is located at the bottom of the wired controller.
 - b) If the gate-control system is connected, make sure the No.1 switch of the DIP switch S1 is turned to the "ON" side. Connect the gate-control terminal to the N and L port or the VCC and GND port. Attention to the following items:
 - a) The N and L port is the power supply interface of the 100-240V~50/60Hz gate control.
 - b) The VCC and GND port is the power supply interface of the DC 5-24V gate control.
 - c) Only one power input can be chosen between the 100-240V~50/60Hz and the DC 5-24V.
- (4) When connecting to terminals, the wire-stripping length for the conducting wire of twisted pair line should be no more than 6mm and the cores of conduction wire can't be exposed to terminal to preventing short-circuit or electric leakage.
- (5) After finishing the wiring, set the wired controller soleplate on the wall and use the M4X25 screws to fix it with the mounting hole.

- (6) Insert the wiring on the soleplate to the socket CN1 on the control panel and then buckle the soleplate and the panel together.

5.1.5 Disassembly

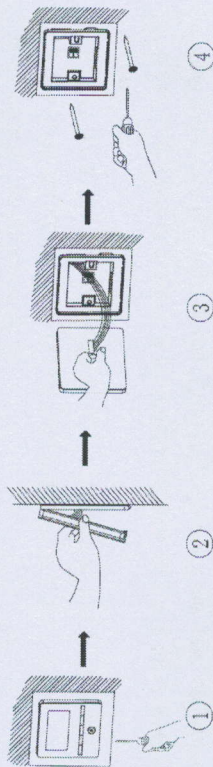

Fig. 5.15 Disassembly diagram of wired controller

5.2 Commissioning

5.2.1 Set Master Indoor Unit

Under Off status, long press MODE button for 5s to set the corresponding indoor unit of wired controller as master indoor unit. "MASTER" icon will be light after finishing setting.



Note

- ① If there is a master indoor unit in a system, other slave indoor units can be set as master unit, in which case, the original master unit will become a slave unit.
- ② In one system, only one set of master indoor unit is allowed. If system detects that there are several master units, it will designate the unit with the smallest project number as a master unit.

5.2.2 Parameter Enquiry





Unit parameters can be checked in unit On or Off status.



- (1) Long press MODE and SWING button for 5s to enter the interface of viewing unit parameters. "C00" is displayed in temperature zone and "CHECK" icon is light;
- (2) Press "↖" or "↘" button to select parameter code;
- (3) Press SWING button to return to last step until exits viewing parameters.

The parameter enquiry list is as following:

Table 5.1 Parameters viewing list

Parameter code	Parameter name	Parameter range	Viewing method
C00	Entrance of adjustable parameter	-	In "C00" status, Timer zone shows the current indoor unit project number. When one wired controller is controlling multiple indoor units, then only the smallest project number will be displayed.
C01	View the project number of indoor unit and locate the faulted indoor unit	1-255; Project number of online indoor unit	Operation method: Enter viewing, press MODE button in "C01" status to enter the interface of viewing indoor unit project number. Press "↖" or "↘" button to select the project number of indoor unit. Display method: Temperature zone: displays error codes of the current indoor unit (The temperature zone will display the error codes in turn with an interval of 3 seconds if there are several malfunctions in one indoor unit.) Timer zone: displays present indoor unit project number /C5 malfunction of project number conflict

Parameter code	Parameter name	Parameter range	Viewing method
C01	View the project number of indoor unit and locate the faulted indoor unit	1-255; Project number of online indoor unit	Note: 1) If master indoor unit exists in current indoor unit network, "MASTER" icon will be bright under "C01" interface. After entering the interface of viewing project number, "MASTER" icon will be bright only when the project number of master indoor unit is selected. 2) System will not exit "C01" viewing automatically. User has to exit this interface manually. The data display area: display indoor unit quantity of the system
C03	View the indoor unit quantity of the system network	1-80	
C06	View priority operation	00: normal operation 01: priority operation	Operation method: Enter viewing: press MODE button in "C06" status to enter the interface of viewing priority operation. Press "  " or "  " button to select indoor unit. Display method: Temperature zone: displays current indoor unit project number. The data display area: displays current priority operation setting value of indoor unit.
C07	View indoor ambient temperature		Operation method: Enter viewing: press MODE button in "C07" status to enter the interface of viewing indoor ambient temperature. Press "  " or "  " button to select indoor unit. Display method: Temperature zone: displays current indoor unit project number; The data display area: displays indoor ambient temperature.

Parameter code	Parameter name	Parameter range	Viewing method
C08	View Filter Clean Reminder time	4-416: days	The data display area: displays Filter Clean Reminder time. Note: The filter-clean reminder function is not available for this wired controller.
C09	View address of wired controller	01, 02	The data display area : displays the address of wired controller.
C11	View the indoor unit quantity in the case that one wired controller controls several indoor units at the same time	1-16	The data display area : displays the indoor unit quantity controlled by the wired controller.
C12	View outdoor ambient temperature		The data display area: displays outdoor ambient temperature
C17	View indoor relative humidity	20~90 relative humidity 20%~90%	Operation method: Enter into review process and press "MODE" button to enter into the review interface of indoor relative humidity under C17 status. Press "  " or "  " button to switch the number of indoor unit. Display method: Temp area: display current indoor unit's project number Timer zone: display indoor relative humidity

Parameter code	Parameter name	Parameter range	Viewing method
C20	View the air outlet temperature of Fresh Air Indoor Unit*	-	<p>Operation method: Enter viewing, short-press "MODE" button in "C20" status to enter the interface of viewing air outlet temperature of Fresh Air Indoor Unit. Press "↖" or "↘" button to select the indoor unit.</p> <p>Display method: Temperature zone: displays current indoor unit project number Timer zone: displays air outlet temperature of Fresh Air Indoor Unit Note: only applicable to Fresh Air Indoor Unit.</p>



Note

- ① Under parameter viewing status, FAN buttons are invalid. Press "ON/OFF" button to go back to the home page, while not to turn on/off the unit.
- ② Under parameter viewing status, the signal from remote controller is invalid.

5.2.3 Parameter Setting

Unit parameters can be set in unit On or Off status.

- (1) Long press MODE and SWING button for 5s and the temperature zone displays "C00"; long press MODE and SWING button for another 5s to enter the interface of setting wired controller parameters. "P00" is displayed in temperature zone;
- (2) Press "↖" or "↘" button to select parameter code. Press MODE button to enter parameter setting. At that time, parameter value is blinking. Press "↖" or "↘" button to adjust the parameter value and press SWING

Parameter code	Parameter name	Parameter range	Viewing method
C18	One-button viewing of indoor unit project number	1-255; Project number of online indoor unit	<p>Operation method: Enter viewing, short-press "MODE" button in "C18" status to turn on the function of one-button viewing indoor unit project code, and the wired controller will enter the interface of viewing indoor unit project code. Press "↖" or "↘" button to select the indoor unit.</p> <p>Display method: Temperature zone: displays number of the current indoor unit Timer zone: displays project number of indoor unit Note: 1) After turning on the one-button viewing function, each wired controller of the entire system will display the project number of its controlling indoor unit on its timer zone. (The timer zone will display different project numbers in turn with an interval of 3 seconds if one wired controller is controlling multiple indoor units.) 2) Slave wired controller cannot view "C18". Cancel method: 1) If user exits the "C18" interface manually, the one-button viewing function will be immediately turned off. 2) If system exits the "C18" interface due to no action in 20 seconds, user has to press the "ON/OFF" button under on/off status to cancel this function. 3) After the one-button viewing function is turned on, pressing the "ON/OFF" button of any wired controller of the same system network under on/off status will cancel this function.</p>

button to finish setting.

(3) Press SWING button to return to last step until exists setting parameters.

The parameter setting list is as following:

Table 5.2 Parameter setting list

Parameter code	Parameter name	Parameter range	Default value	Note
P10	Set master indoor unit	00: do not change current master/slave state of indoor unit 01: set current indoor unit as master indoor unit	00	When set the corresponding indoor unit of wired controller as master indoor unit, MASTER icon will be bright after finishing setting.
P11	Set infrared receiver of wired controller	00: forbidden 01: activated	01	It can be set only through master wired controller. When infrared receiver of wired controller is forbidden, the wired controller can't receive the signal from remote controller and it is operated through buttons.
P13	Set address of wired controller	01: master wired controller 02: slave wired controller	01	When two wired controllers control one indoor unit (or several indoor units), the addresses of the two wired controllers should be different. Assistant wired controller (02) is without unit parameter setting function except setting its address.
P14	Set quantity of group control indoor units	00: forbid this function 01-16: indoor unit quantity	01	Set the corresponding value according to the connected indoor unit quantity.

Parameter code	Parameter name	Parameter range	Default value	Note
P16	Set unit of temperature	00: Celsius 01: Fahrenheit	00	There are two kinds of static pressure level: 5 levels: 03, 04, 05, 06, 07 9 levels: 01, 02, 03, 04, 05, 06, 07, 08, 09
P30	Set static pressure of indoor fan motor	01-09: static pressure level of indoor fan motor	05	Static pressure level range is different for different models: the wired controller will automatically select static pressure level range of indoor fan motor according to the model of indoor unit.
P31	High ceiling installation*	00: installation height of standard ceiling 01: installation height of high ceiling	00	Only applicable to cassette units
P33	Set Timer	00: general timer 01: clock timer	00	This setting is valid when it is used to control one (multiple) indoor unit (s) with other wired controller (s) with timer function.
P34	Clock Timer repetition is valid	00: once 01: repeat everyday	00	This setting is valid when it is used to control one (multiple) indoor unit (s) with other wired controller (s) with timer function, and when the unit timer function is set "Clock Timer".

Parameter code	Parameter name	Parameter range	Default value	Note
P54	Union setting of Fresh Air Indoor Unit*	00: without union control 01: with union control	00	After union function is set, Fresh Air Indoor Unit will be turned on/off following the on/off status of common indoor unit. Besides, Fresh Air Indoor Unit can also be turned on/off manually. Note: only applicable to Fresh Air Indoor Unit.



Note

- ① Under parameter setting status, FAN button are invalid. Press ON/OFF button to go back to home page, but not turning on/off the unit.
- ② Under parameter setting status, the signal from remote controller is invalid.

Parameter code	Parameter name	Parameter range	Default value	Note
P37	Cooling setting temperature under auto mode	17°C~30°C(63°F~86°F)	25°C (77°F)	When the temperature unit is °C, cooling setting temperature minus heating setting temperature ≥ 1°C. When the temperature unit is °F, cooling setting temperature minus heating setting temperature ≥ 2°F.
P38	Heating setting temperature under auto mode	16°C~29°C(61°F~84°F)	20°C (68°F)	
P43	Set priority operation	00: normal operation 01: priority operation	00	When power supply is insufficient, the indoor units which are set to priority operation can operate, while other indoor units are forced to be turned off.
P46	Clear Filter Clean accumulated time	00: do not clear 01: clear	00	Note: The filter-clean reminder function is not available for this wired controller.
P49	Opening angle of indoor unit air-return plate*	01: angle 1(25°) 02: angle 2(30°) 03: angle 3(35°)	01	Only applicable to units with air-return plate
P50	Air outlet temperature setting for Fresh Air Indoor Unit in cooling*	16°C~30°C	18°C	Only applicable to Fresh Air Indoor Unit.
P51	Air outlet temperature setting for Fresh Air Indoor Unit in heating*	16°C~30°C	22°C	Only applicable to Fresh Air Indoor Unit.

6 OPERATION INSTRUCTIONS

6.1 On/Off

Press ON/OFF button to turn on the unit.

Press ON/OFF button again to turn off the unit.

The interfaces of On/Off status are shown in fig. 6.1 and 6.2.

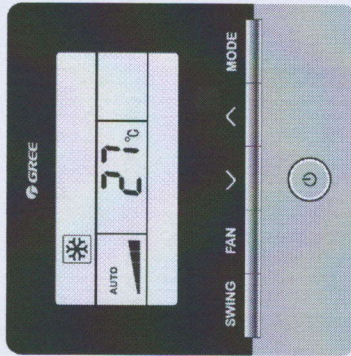

Fig. 6.1 Interface of On status



Fig. 6.2 Interface of Off status

6.2 Mode Setting

Under On status, pressing MODE button can set mode circularly as:



Note:

- ① the available modes are different for different models, the wired controller will automatically select mode setting range according to the model of indoor unit.
- ② The Auto mode can be only set at the master indoor unit.
- ③ Under Auto mode, if the indoor unit is running under Cool, the icons "❄️" and "☔️" will light up; if the indoor unit is running under Heat, the icons "☀️" and "🔺" will light up.

6.3 Temperature Setting

Pressing "⤴️" or "⤵️" button in On status increases or decreases set temperature by 1°C; holding "⤴️" or "⤵️" button increases or decreases set temperature by 1°C every 0.3s. In Cooling, Fan, Heating, Dry mode, temperature setting range is 16°C~30°C.

! Note

- ① Under Auto mode, the unit temperature can not be adjusted by “^” or “v” button.
- ② When the wired controller is connected with a Fresh Air Indoor Unit, fresh air indoor unit code “FAP” will be displayed as shown below. Setting temperature won't be displayed and can't be adjusted “^” or “v” button. The air outlet temperature in cooling or heating can only be set in the parameter setting status.

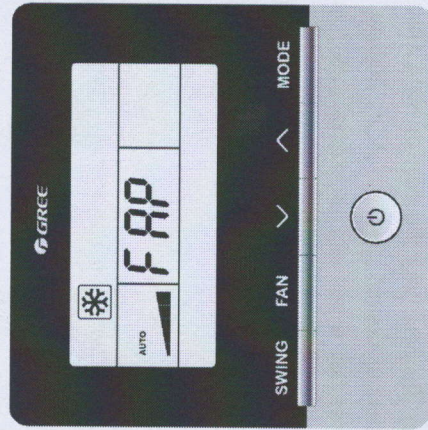

6.4 Fan Setting

Under On status, pressing FAN button can set fan speed circularly as:



Note:

- ① In Dry mode, fan speed is low and can't be adjusted.
- ② When the wired controller is connected with a Fresh Air Indoor Unit, fan speed of indoor unit will be high fan speed only. Fan speed of indoor unit can't be adjusted via “FAN” button
- ③ If indoor unit's fan speed is set auto, indoor unit will change fan speed automatically according to room temperature in order to make the room temperature more stable and comfortable.

6.5 Swing Setting

Under unit on, press SWING button to activate or cancel Swing function. The icon “” lights up when Swing function is activated.

6.6 Remote Shield Function

Remote Shield Function: Remote monitor or central controller can disable the relevant functions of wired controller so as to realize the function of remote control.

Remote Shield Function includes all shield and partial shield. When All Shield

function is on, all controls of the wired controller are disabled. When Partial Shield function is on, those controls that are shielded will be disabled.

When the remote monitor or central controller activates Remote Shield on the wired controller, "SHIELD" icon will show. If user wants to control through the wired controller, "SHIELD" icon will blink to remind that these controls are disabled.

6.7 Child Lock Function

When unit is turned on normally or turned off, pressing "∧" and "∨" button together for 5 seconds will turn on Child Lock function. "🔒" will show on the display. Pressing "∧" and "∨" together again for 5 seconds to turn off this function.

All the other buttons will be disabled when Child Lock function is on.

6.8 Gate-control Function

When there is Gate-control System, user can insert a card to turn on the unit or pull off a card to turn off the unit. When the card is re-inserted, the unit will recover the operation as state in memory. When the card is pulled off (or improperly inserted), "🔑" icon will show, neither remote control nor operation of wired controller will be effective and icon "🔑" will be flickering.

7 ERROR DISPLAY

When there occurs any error during operation, the temperature display zone on the wired controller will show error codes. If several errors happen at the same time, error codes will show on the display repeatedly.

Note: If error occurs, please turn off the unit and send for professionals to repair.

Fig. 6.1 is the display of outdoor high pressure protection error code when unit is on.



Fig.6.1 Display of outdoor high pressure protection error code

7.1 Table of Error Codes for Outdoor Unit

Error Code	Content	Error Code	Content	Error Code	Content
E0	Outdoor Unit Error	FP	Malfunction of DC motor	b4	Subcooler Liquid-out Temperature Sensor Error
E1	High Pressure Protection	FU	Compressor 2 Top Temperature Sensor Error	b5	Subcooler Gas-out Temperature Sensor Error
E2	Discharge Low Temperature Protection	Fb	Compressor 2 Top Temperature Sensor Error	b6	Gas-liquid separator inlet temperature sensor error
E3	Low Pressure Protection	J1	Compressor 1 Over-current Protection	b7	Gas-liquid separator outlet temperature sensor error
E4	Excess Discharge Temperature Protection of Compressor	J2	Compressor 2 Over-current Protection	b8	Outdoor Humidity Sensor Error
F0	Bad Performance of the Outdoor Mainboard	J3	Compressor 3 Over-current Protection	b9	Heat Exchanger Gas-out Temperature Sensor Error
F1	High Pressure Sensor Error	J4	Compressor 4 Over-current Protection	bA	Oil-return Temperature Sensor Error
F3	Low Pressure Sensor Error	J5	Compressor 5 Over-current Protection	bH	System Clock Malfunction
F5	Compressor 1 Discharge Temperature Sensor Error	J6	Compressor 6 Over-current Protection	bC	Compressor 1 Top Temperature Sensor Detachment Protection

Error Code	Content	Error Code	Content	Error Code	Content
F6	Compressor 2 Discharge Temperature Sensor Error	J7	4-way Valve Blow-by Protection	bL	Compressor 2 Top Temperature Sensor Detachment Protection
F7	Compressor 3 Discharge Temperature Sensor Error	J8	System Pressure Over-Ratio Protection	bE	Malfunction of entry tube temperature sensor of condenser
F8	Compressor 4 Discharge Temperature Sensor Error	J9	System Pressure Under-Ratio Protection	bF	Malfunction of exit tube temperature sensor of condenser
F9	Compressor 5 Discharge Temperature Sensor Error	JA	Protection of Abnormal Pressure	bJ	High and low pressure sensors are connected inversely
FA	Compressor 6 Discharge Temperature Sensor Error	JC	Protection of Water Flow Switch	P0	Compressor Drive Board Error
FH	Compressor 1 Current Sensor Error	JL	Protection of Low High-pressure	P1	Compressor Drive Board Malfunction
FC	Compressor 2 Current Sensor Error	JE	Oil return pipe is blocked	P2	Protection of Compressor Drive Board Power Supply
FL	Compressor 3 Current Sensor Error	JF	Oil return pipe is leaking	P3	Protection of Compressor Drive Board Module Reset
FE	Compressor 4 Current Sensor Error	b1	Outdoor Ambient Temperature Sensor Error	H0	Error of Fan Drive Board
FF	Compressor 5 Current Sensor Error	b2	Defrosting Temperature Sensor Error	H1	Malfunction of Fan Drive Board

Error Code	Content	Error Code	Content	Error Code	Content
L8	Power Insufficiency Protection	d5	Malfunction of middle tube temperature sensor	dE	Indoor Unit CO ₂ Sensor Error
L9	Quantity Of Group Control Indoor Units Setting Error	d6	Outlet Pipe Temperature Sensor Error	db	Special Code: Field Debugging Code

7.3 Table of Status Codes

Error Code	Content	Error Code	Content
A0	Unit is waiting for debugging.	AU	Remote Urgent Stop
A1	Check the compressor operation parameters.	Ab	Emergency Stop
A2	After-sales Refrigerant Reclaim	Ad	Operation Restriction
A3	Defrosting	An	High temperature prevention control
A4	Oil return	n3	Compulsory defrosting
A5	Online Testing	n5	Compulsively excursion of indoor unit project number
A8	Vacuum-pumping Mode	nL	Target low pressure modification
AH	Heating	nJ	High temperature prevention under heating mode
AC	Cooling	nP	Temperature-adjusting value during defrosting
AF	Fan	nU	Clear the remote control shielding order of indoor unit
AJ	Filter Clean Reminder		

Error Code	Content	Error Code	Content
FJ	Compressor 6 Current Sensor Error	b3	Defrosting Temperature Sensor 2 Error
		H2	Protection of Fan Drive Board Power Supply

7.2 Table of Error Codes for Indoor Unit

Error Code	Content	Error Code	Content
L0	Indoor Unit Error	LA	Indoor Units Incompatibility Error
L1	Indoor Fan Protection	LH	Low Air Quantity Warning
L2	E-heater Protection	LC	Outdoor-Indoor Incompatibility Error
L3	Water Full Protection	LP	Zero-crossing malfunction of PG motor
L4	Wired Controller Power Supply Error	d1	Indoor Unit PC-Board Error
L5	Anti-Frosting Protection	d3	Ambient Temperature Sensor Error
L7	No Master Indoor Unit Error	d4	Inlet Pipe Temperature Sensor Error
		d7	Humidity Sensor Error
		d8	Water Temperature Sensor Error
		d9	Jumper Cap Error
		dA	Indoor Unit Hardware Address Error
		dH	Wired Controller PC-Board Error
		dC	Capacity DIP Switch Setting Error.
		dL	Outlet Air Temperature Sensor Error

7.4 Table of Debugging Codes

Error Code	Content	Error Code	Content	Error Code	Content
U2	Outdoor Unit Capacity Code/Jumper Cap Setting Error	UE	Refrigerant Charging is ineffective.	CH	Rated capacity is too high.
U3	Phase Sequence Protection of Power Supply	UL	Emergency Operation DIP switch setting of the compressor is wrong.	CL	Rated capacity is too low.
U4	Protection of Lack of Refrigerant	C0	Communication between indoor unit and outdoor unit and the communication between indoor unit and wired controller have malfunction.	CF	Error of Multiple Master Indoor Unit
U5	Wrong Address of Compressor Drive Board	C2	Communication error between master control and inverter compressor drive	CJ	System addresses is incompatible.
U6	Valve Abnormal Alarm	C3	Communication error between master control and inverter fan motor drive	CP	Error of Multiple Master Wired Controller
U8	Indoor Unit Tube Malfunction	C4	Error of Lack of Indoor Unit	CU	Communication Error between Indoor Unit and Remote Receiver
U9	Outdoor Unit Tube Malfunction	C5	Alarm of Indoor Unit Project Number Collision	Cb	Outflow of Units IP Address
UC	Master indoor unit is successfully set.	C6	Alarm of Wrong Number of Outdoor Unit	-	-