



# ***Owner's Manual***

## **Original Instructions**

Wired Controller (XK86 and XE76-33/H)

Thank you for choosing this product. Please read this Owner's Manual carefully before operation and retain it for future reference.

If you have lost the Owner's Manual, please contact the local agent or visit [www.gree.com](http://www.gree.com) or send an email to [global@gree.com.cn](mailto:global@gree.com.cn) for the electronic version.

GREE ELECTRIC APPLIANCES, INC. OF ZHUHAI

## To Users

Thank you for selecting Gree's product. Please read this instruction manual carefully before installing and using the product, so as to master and correctly use the product. In order to guide you to correctly install and use our product and achieve expected operating effect, we hereby instruct as below:

- (1) This appliance is not intended for use by persons (including children) with reduced physical, sensory or mental capabilities, or lack of experience and knowledge, unless they have been given supervision or instruction concerning use of the appliance by a person responsible for their safety. Children should be supervised to ensure that they do not play with the appliance.
- (2) This instruction manual is a universal manual, some functions are only applicable to particular product. All the illustrations and information in the instruction manual are only for reference, and control interface should be subject to actual operation.
- (3) In order to make the product better, we will continuously conduct improvement and innovation. We have the right to make necessary revision to the product from time to time due to the reason of sales or production, and reserve the right to revise the contents without further notice.
- (4) For personal injury or property loss and damage caused by improper

operation such as improper installation and debugging, unnecessary maintenance, violation of related national laws and rules and industrial standard, and violation of this instruction manual, etc., we will bear no liability.

- (5) The final right to interpret for this instruction manual belongs to Gree Electric Appliances Inc. of Zhuhai.



This marking indicates that this product should not be disposed with other household wastes throughout the EU. To prevent possible harm to the environment or human health from uncontrolled waste disposal, recycle it responsibly to promote the sustainable reuse of material resources. To return your used device, please use the return and collection systems or contact the retailer where the product was purchased. They can take this product for environmental safe recycling.

## Contents

<b>1 Safety Notices (Please be sure to abide them)</b> .....	<b>1</b>
<b>2 Operation Notices</b> .....	<b>2</b>
<b>3 Appearance and Display</b> .....	<b>4</b>
<b>4 Status Bar Instructions</b> .....	<b>5</b>
<b>5 Installation and Commissioning</b> .....	<b>7</b>
5.1 Installation of Wired Controller .....	11
5.2 Commissioning .....	20
<b>6 Operation Instructions</b> .....	<b>30</b>
6.1 On/Off .....	30
6.2 Mode Setting.....	31
6.3 Temperature Setting.....	33
6.4 Fan Setting .....	34
6.5 Schedule Setting.....	35
6.6 Function Setting .....	40
6.7 Service Hotline Query .....	51
6.8 Language Setting.....	52

6.9 Sound Setting .....	52
6.10 Date and Time Setting.....	52
6.11 Remote Shield Function .....	52
6.12 Gate-control Function.....	53
6.13 Inquiry of Indoor Temperature with One Button .....	53
<b>7 Error Display .....</b>	<b>53</b>
7.1 Table of Error Codes for Outdoor Unit .....	54
7.2 Table of Error Codes for Indoor Unit.....	56
7.3 Table of Debugging Codes .....	59
7.4 Table of Status Codes .....	61

## 1 Safety Notices (Please be sure to abide them)



**WARNING:** If not abide them strictly, it may cause severe damage to the unit or the people.



**NOTE:** If not abide them strictly, it may cause slight or medium damage to the unit or the people.



This sign indicates that the items must be prohibited. Improper operation may cause severe damage or death to people.



This sign indicates that the items must be observed. Improper operation may cause damage to people or property.



**WARNING!**

This product can't be installed at corrosive, inflammable or explosive environment or the place with special requirements, such as kitchen. Otherwise, it will affect the normal operation or shorten the service life of the unit, or even cause fire hazard or serious injury. As for the above special places, please adopt special air conditioner with anti-corrosive or anti-explosion function.

## 2 Operation Notices

- ◆ The power supply for all indoor units must be unified.
- ◆ Prohibit installing the wired controller at wet or sunshine places.
- ◆ Do not knock, throw or frequently disassemble the wired controller.
- ◆ Do not operate the wired controller with wet hands.
- ◆ When the system mode priority is the master-slave mode, in one system network, you must set one indoor unit as the master indoor unit, Other indoor units are slave indoor units .
- ◆ When the system mode priority is the master-slave mode, the operation mode of the system is basing on that of the master indoor unit. The master indoor unit can be set to any mode (including auto mode), while the slave indoor unit can't set to the mode that conflicts with the system mode.
- ◆ When the system mode priority is: Cooling mode is prioritized, heating mode is prioritized, first-set mode is prioritized, or last-set mode is prioritized. The indoor unit can be set to any mode (excluding auto mode). The indoor unit will automatically switch to the system mode, when the operation mode of the indoor unit conflicts with the system operation mode.
- ◆ When the system mode priority is the voting mode (indoor unit's capacity is prioritized / number of indoor units is prioritized). The indoor unit can be set to any mode (excluding the auto mode). The indoor unit will be stopped, when the operation mode of the indoor unit conflicts with the system operation mode after voting.

- ◆ System mode priority defaults to master-slave mode, and only certain units have other system mode priorities.
- ◆ When two wired controllers control one (or more) indoor unit(s), the address of wired controller should be different.
- ◆ Functions with “\*” are optional for indoor units. If a function is not included in an indoor unit, wired controller can't set the function, or setting of this function is invalid to the indoor unit.



### 3 Appearance and Display

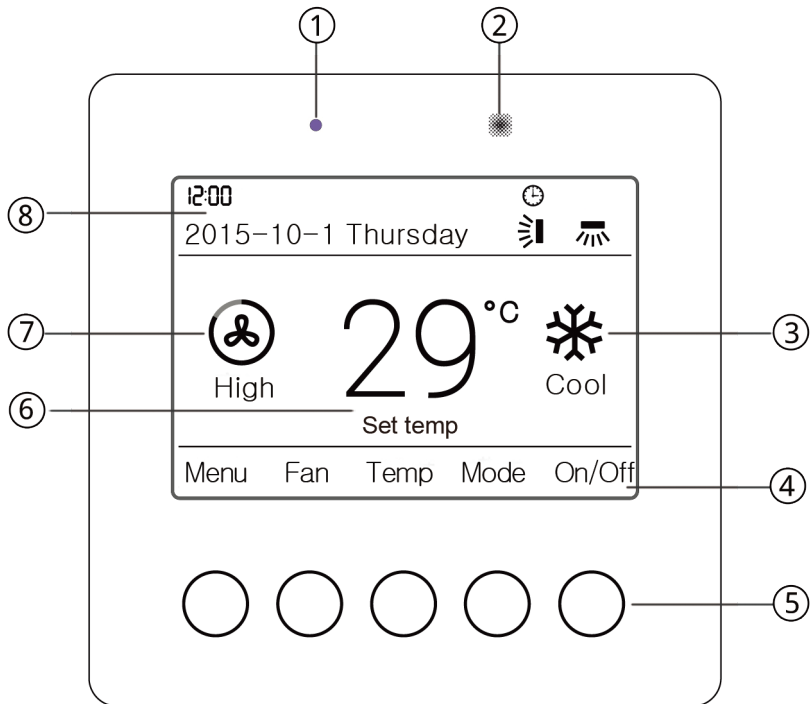





Fig.3.1 Appearance and display

Table 3.1 Appearance and display instructions











No.	Name	Instructions
1	LED	Light up when buttons are pressed or signals are received from remote controller
2	Remote signal receiving window	For receiving signals from remote controller
3	Mode display	Indicating the operating mode
4	Names of buttons	Indicating the names of buttons
5	Touch buttons	Corresponding to the names of buttons
6	Temperature display	Display set temperature or environment temperature
7	Fan speed display	Indicating set fan speed
8	Status bar	Indicating date, time, and activated functions

## 4 Status Bar Instructions

Table 4.1 Status bar instructions

Icon	Name	Instructions
	Up and down swing	Up and down swing
	Left and right swing	Left and right swing
	Master	If the current wired controller is connected with a master indoor unit, this icon will be displayed (If it is connected with a heat recovery unit or temperature-humidity dual-control duct type indoor unit, this icon won't be displayed)

## Wired Controller (XK86 and XE76-33/H)

Icon	Name	Instructions
	Group control	If one wired controller is controlling multiple indoor units, this icon will be displayed
	Slave wired controller	Indicating the current wired controller is a slave wired controller (address is 02)
	Shield	Shield status
	Gate-control	Indicating the gate-control card is pulled out
	Child lock	Child lock status
	Invalid	Indicating invalid operation
	Malfunction	Indicating that the unit is malfunctioning
	Memory	Memory status (When power is connected after power failure, indoor unit will resume its previous settings)
	Defrost	Indicating that outdoor unit is under defrosting status
	Schedule	Indicating schedule function is activated
	Clean	Indicating filter cleaning reminder is on

## 5 Installation and Commissioning

(1) Dimension and parts of XE76-33/H:

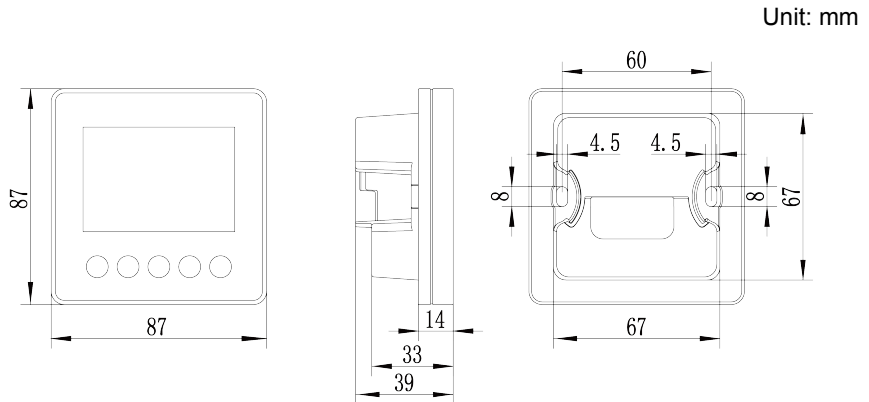

Fig. 5.1 Dimension of XE76-33/H

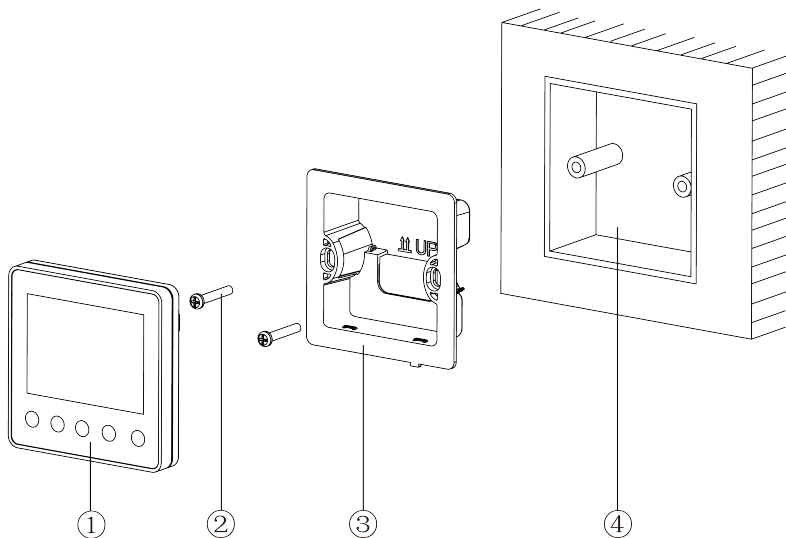

Fig. 5.2 Parts of XE76-33/H

No.	①	②	③	④
Name	Panel of wired controller	Screw M4*25	Soleplate of wired controller	Junction box mounted in the wall space
QTY	1	2	1	Parts supplied by users

(2) Dimension and parts of XK86:

Unit: mm

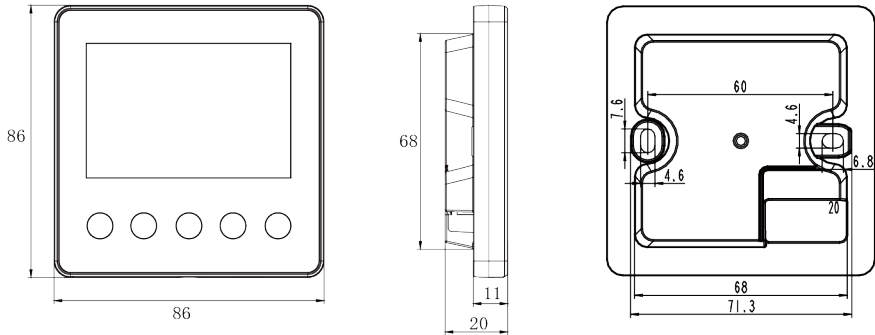

Fig. 5.3 Dimension of XK86

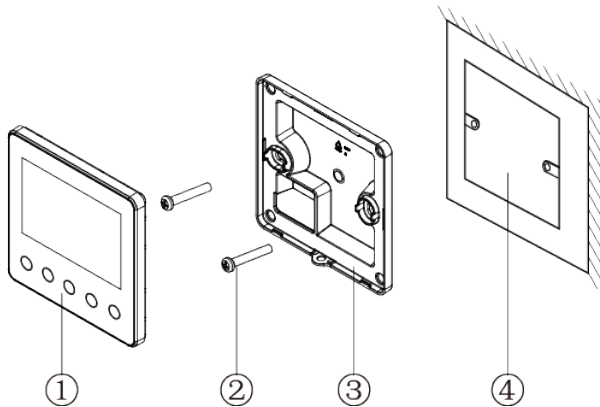

Fig. 5.4 Parts of XK86

No.	①	②	③	④
Name	Panel of wired controller	Screw M4*25	Soleplate of wired controller	Junction box mounted in the wall space
QTY	1	2	2	Parts supplied by users

## 5.1 Installation of Wired Controller

### 5.1.1 Communication Line Selection

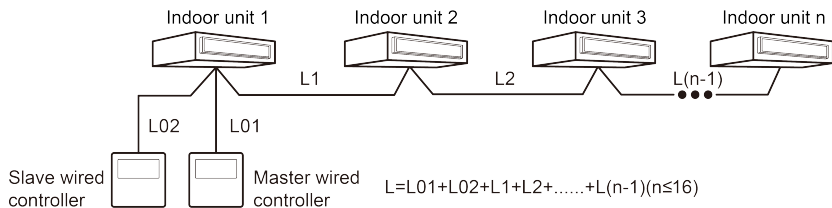

Fig. 5.5 Length of communication line

Wire material type	Total length of communication line between indoor unit and wired controller L (m/feet)	Wire size (mm <sup>2</sup> /A WG)	Material standard	Remarks
Light/Ordinary polyvinyl chloride sheathed cord. (60227 IEC 52 /60227 IEC 53)	$L \leq 250\text{m}$ ( $L \leq 820\text{-}1/5\text{feet}$ )	$2 \times 0.75 \sim 2 \times 1.25$ ( $2 \times \text{AWG}$ $18 \sim 2 \times \text{A}$ $\text{WG}16$ )	IEC 60227-5: 2007	<ul style="list-style-type: none"> <li>① Total length of communication line can't exceed 250m (820-1/5feet).</li> <li>② The cord shall be Circular cord (the cores shall be twisted together).</li> <li>③ If unit is installed in places with intense magnetic field or strong interference, it is necessary to use shielded wire.</li> </ul>



**NOTES:**

- ① If the air conditioner is installed at the strong electromagnetic interference place, communication line of the wired controller must use shielding twisted pair.
- ② Materials of communication line for wired controller must be selected according to this instruction manual strictly.

### 5.1.2 Installation Requirements

- (1) Prohibit installing the wired controller at wet places.
- (2) Prohibit installing the wired controller at direct sunshine places.
- (3) Prohibit installing the wired controller at the place near high temperature objects or water-splashing places.
- (4) Prohibit installing the wired controller at the place where faces forward to the window. Prevent abnormal work due to the interference from the other wired controller around.

### 5.1.3 Wiring Requirements

There are four network wiring methods between wired controller and indoor unit:

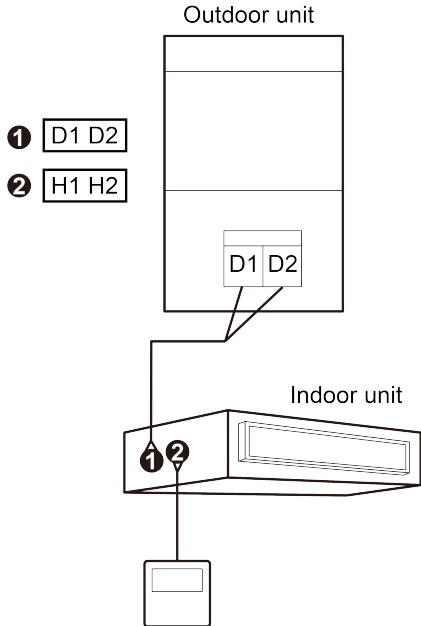

Fig. 5.6 One wired controller controls one indoor unit

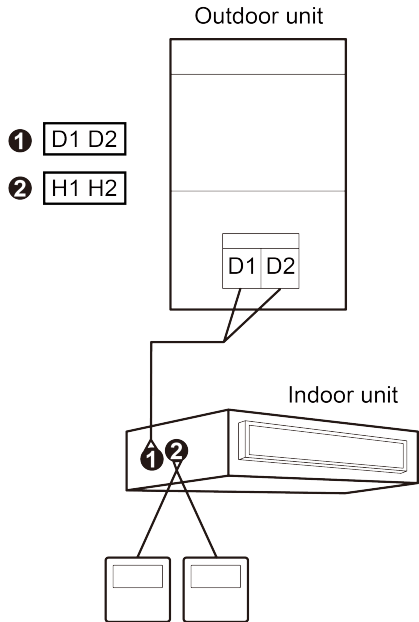

Fig. 5.7 Two wired controllers control one indoor unit

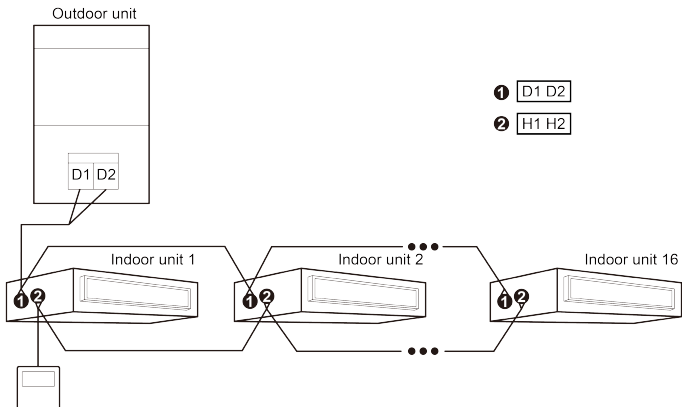

Fig. 5.8 One wired controller controls multiple indoor units simultaneously

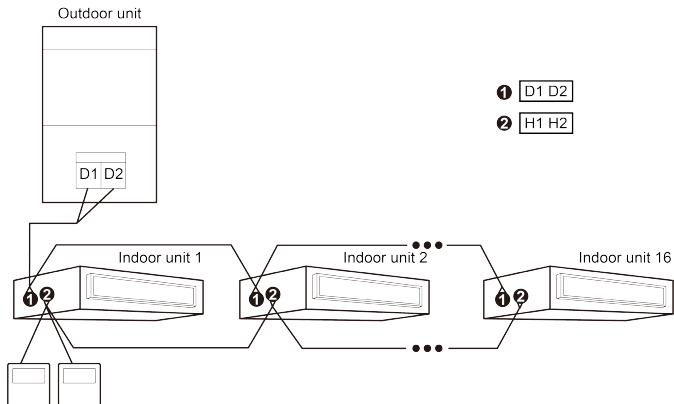

Fig. 5.9 Two wired controllers control multiple indoor units simultaneously

Wiring instruction:

- (1) When one wired controller controls multiple indoor units simultaneously, the wired controller can connect to any one indoor unit, but the connected ones must be units of the same series. The total quantity of indoor unit controlled by wired controller can't exceed 16 sets, and the connected indoor unit must be within the same network. The number of indoor units in group control must be set. Please refer to section 5.2.2 Parameter Setting for the setting method.
- (2) When two wired controllers control one indoor unit, the addresses of those two wired controllers should be different. One should be master controller and the other should be slave controller. Please refer to section 5.2.2 Parameter Setting for the setting method.
- (3) When two wired controllers control multiple indoor units simultaneously, they can connect to any one indoor unit, but the connected ones must be units of the same series. One should be master controller and the other should be slave controller. Please refer to 5.2.2 Parameter Setting for the setting method of master and slave wired controllers. The total quantity of units controlled by wired controller can't exceed 16 sets, and the connected indoor units must be within the same network. The number of units in group control must be set. Please refer to section 5.2.2 Parameter Setting for the setting method.
- (4) When one (or two) wired controller(s) control (s) multiple indoor units at the

same time, the controlled units should have the same setting.

- (5) Network connection of wired controller and indoor units must be according to one of the four wiring methods as shown in fig 5.6-5.9. As for the connection method shown in fig 5.7 and 5.9, there should be only one master wired controller (address is 01) and one slave wired controller (address 02). The quantity of wired controller can't exceed two.

**NOTE:** Series of indoor units include:

- ① Common Multi VRF Units;
- ② Fresh Air Units;
- ③ Double-heat Sources Units;
- ④ Combined Units; Except for fresh air units, double-heat sources units and combined units, the rest of indoor units belong to common multi VRF units.

### 5.1.4 Installation

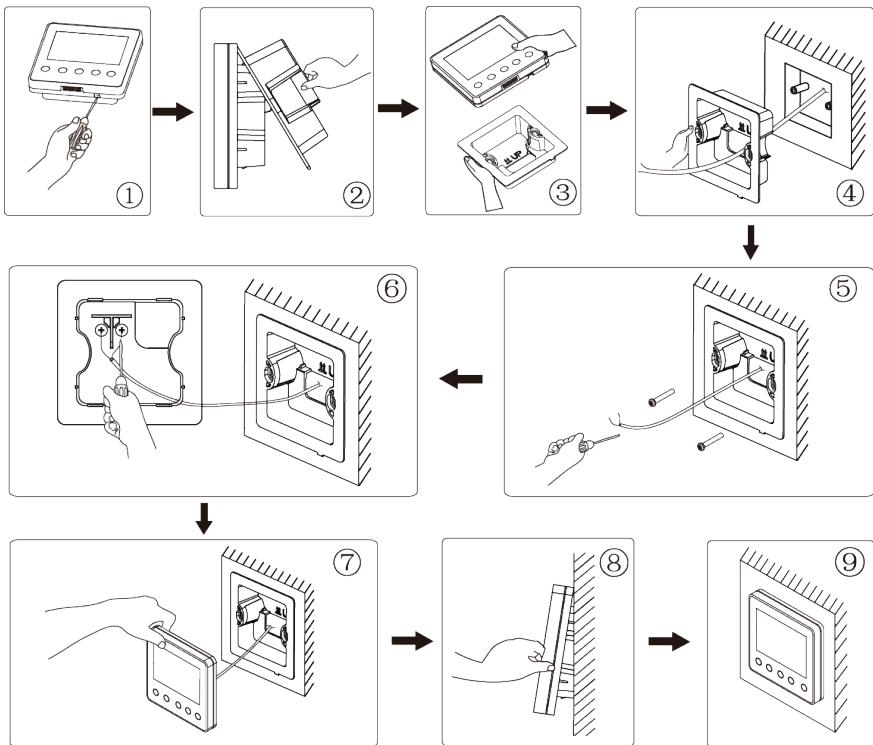

Fig. 5.10 Installation diagram of XE76-33/H

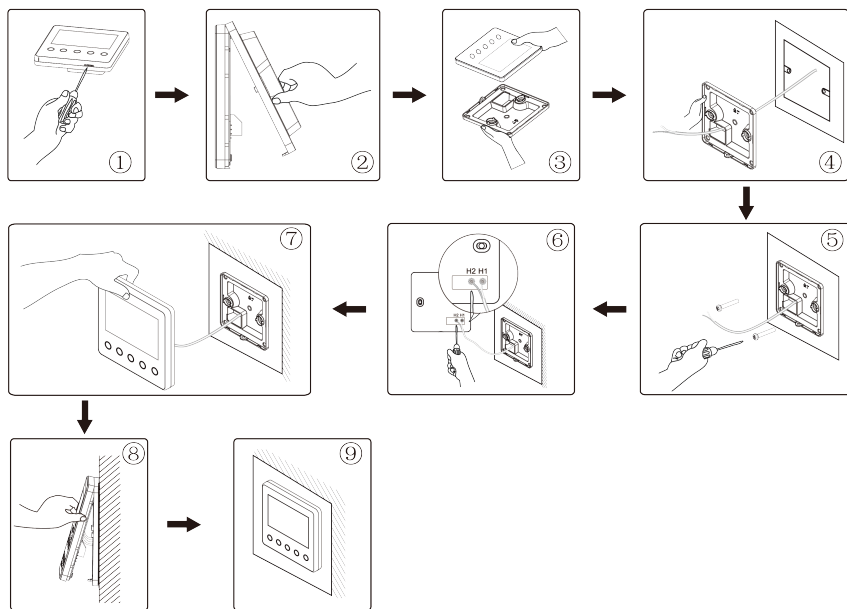

Fig. 5.11 Installation diagram of XK86

Please pay attention to the following items:

- (1) Before installation, please cut off the power for indoor unit.
- (2) Pull out the 2-core twisted pair from the installation hole on wall, and pull this wire through the connecting hole at the rear side of the soleplate of wired controller.

- (3) Stick the bottom plate of wired controller on the wall and then use screw M4×25 to fix Soleplate and installation hole on wall together.
- (4) Connect two-core twisted pair to H1 and H2 wiring column and then fix the screws.
- (5) Bundle the front panel of wired controller to its soleplate and the installation is completed.

### 5.1.5 Disassembly

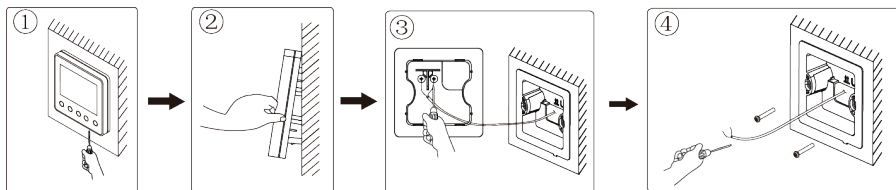

Fig. 5.12 Disassembly diagram of XE76-33/H

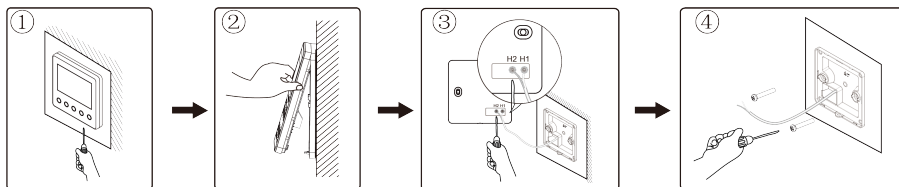

Fig. 5.13 Disassembly diagram of XK86

**NOTE:** Please use the flathead screwdriver to disassemble the wired controller as shown in figure ①, in order to remove the panel and soleplate of the wired controller.



## 5.2 Commissioning

### 5.2.1 Parameter Enquiry

Parameters can be checked whether unit is on or off.

Press "Menu" button on homepage to enter the menu page. Then select "View" to enter the interface of view. Then select "Project View" to enter the interface of project view, as shown below.

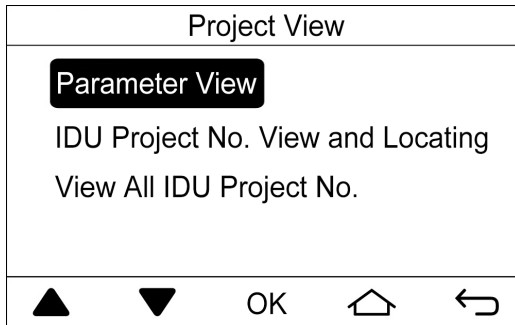

(1) IDU project No. view and locating

On the interface of project view, select "IDU Project No. View and Locating". As shown below, indoor unit project number and error code will be displayed.

<IDU1> Project No. View and Locating		
IDU Project No. : 15 IDU Error : L1		
IDU-	IDU+	↩

If there are multiple indoor units, press "IDU-" or "IDU+" to switch different indoor units. Project numbers and error codes of indoor units will be displayed correspondingly. If there are several errors in one indoor unit, error codes will be displayed circularly at an interval of 3 seconds. If there is no error, "Null" will be displayed.

After entering the interface of IDU project number view and locating, buzzer of the selected indoor unit will ring until the wired controller exits the interface.

(2) View all IDU project No.

On the interface of project view, select "View All IDU Project No.". As shown below, turn on or turn off "View All IDU Project No.".

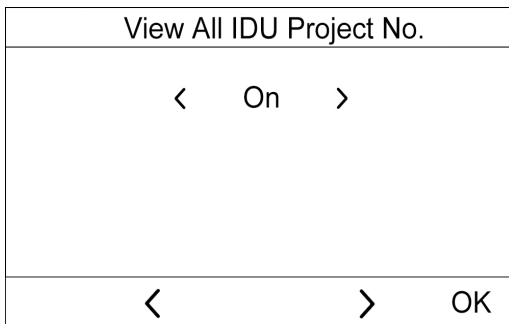





After turning on "View All IDU Project No.", all indoor units and wired controllers of the same network will display project numbers. For wired controller, it will display the project numbers of indoor units one by one from small number to large number at an interval of 3 seconds.



After turning on "View All IDU Project No.", you can enter the interface of "View All IDU Project No." to turn this function off, or you can press "On/Off" button on any one wired controller of the network to cancel the display of indoor unit project numbers.

### (3) Parameter view

On the interface of project view, select "Parameter view". As shown below, a list of parameters can be enquired. Please refer to table 5.1 "List of parameters view".

Parameter View		1/12	
Wired Controller's Address : 1			
Number of IDUs : 5			
Master IDU's Project No. : 3			
Time Left to Clean Filter : 30 Days			
			

When enquiring indoor unit parameters, if there are multiple indoor units, press "IDU-" or "IDU+" to switch different indoor units. Parameters of the corresponding unit will be shown as below.

<IDU1> IDU Parameter View		3/12	
IDU Error Log : L1, L4, d3, d4, d6			
Prior Operation : No			
Indoor Temp : 25°C			
Relative Humidity : 65%			
		IDU-	IDU+ 

When enquiring outdoor unit parameters, if there are multiple outdoor units, press "ODU-" or "ODU+" to switch different outdoor units. Parameters of the

corresponding outdoor unit will be shown as below.



<ODU1> ODU Parameter View 7/12			
ODU Static Pressure : 50 Pa			
ODU Error Log : C2			
Outdoor Temp : 30°C			
Comp1 Operation Freq : 100Hz			
		ODU-	ODU+ 

Table 5.1 List of parameters enquiry

Parameter name	scope	Parameter name	scope
Wired Controller's Address	1, 2	Number of IDUs	1~16
Master IDU's Project No.	1~255	Time Left to Clean Filter	0~416 days
Online IDUs of CAN1	1~100	CAN2 Address	1~255
Max Distribution Ratio	110%, 135%, 150%	Cool & Heat Modes	Cool only; Heat only; Cool & heat; Fan
IDU Error Log	5 historical errors	Prior Operation	Yes, No
Indoor Temp	-9~99°C	Relative Humidity	20%~90%
Inlet Temp 1	-9~99°C	Outlet Temp 1	-9~99°C
Inlet Temp 2	-9~99°C	Outlet Temp 2	-9~99°C

Wired Controller (XK86 and XE76-33/H)

Parameter name	scope	Parameter name	scope
IDU Capacity	Indoor unit capacity and capacity after adjustment	EXV Status	0~20
Fresh Air IDU Output Temp	Actual value	IDU Static Pressure	0~999
ODU Static Pressure	0, 20, 50, 80	ODU Error Log	5 historical errors
<b>The following parameters can be checked only on the master wired controller.</b>			
Unit Code	0~9, A~Z, a~z,-	Board Code	0~9, A~Z, a~z,-
Outdoor Temp	-30~139°C	Comp1 Operation Freq	0~200Hz
Comp2 Operation Freq	0~200Hz	ODU Fan Operation Freq	0~100Hz
Module High Pressure	-40~70°C	Module low pressure	-69~38°C
Comp1 Discharge Temp	-30~150°C	Comp2 Discharge Temp	-30~150°C
Comp3 Discharge Temp	-30~150°C	Comp4 Discharge Temp	-30~150°C
Comp5 Discharge Temp	-30~150°C	Comp6 Discharge Temp	-30~150°C
Comp3 Operation Freq	0~200Hz	ODU Heating EXV1	0~48
ODU Heating EXV2	0~48	Subcooler EXV	0~48
Defrosting Temp	-30~139°C	Subcooler Liquid Temp	-30~139°C
Separator Outlet Temp	-30~139°C	Oil Return Temp	-30~139°C
Condenser Inlet Temp	-30~139°C	Condenser Outlet Temp	-30~139°C

**NOTES:**

- ① Under the status of parameter enquiry, signals from remote controller are ineffective.
- ② If a parameter is invalid, wired controller displays “—”.

### 5.2.2 Parameter Setting

Unit parameters can be set in unit On or Off status.

Press "Menu" button on homepage to enter the menu page. Then select "Set" to enter the interface of settings. Then select "Project set" to enter the interface of project parameter setting, as shown below. Please refer to table 5.2 for the list of parameter settings.

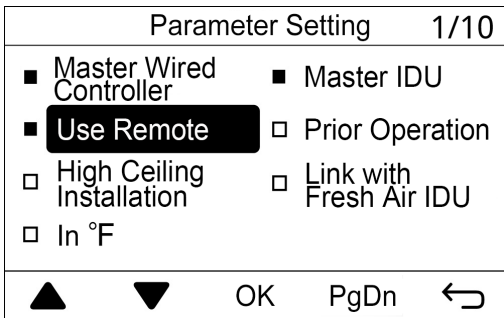



Press “▲” or “▼” to switch among different settings. Press and hold the buttons to switch quickly.

If you select a parameter with “■” or “□” on the left, press “OK” to turn it on or turn it off. “■” means ON while “□” means OFF. If you select a parameter with icon “➤” on the left, press “OK” to enter the setting interface of the corresponding parameter.

Press “PgDn” button to switch to the next page.

Table 5.2 List of parameter settings

Setting	Setting scope	Default	Remarks
Master Wired Controller	ON, OFF	ON	OFF means this wired controller is a slave wired controller. The icon of slave wired controller “  ” will be displayed on homepage. Slave wired controller cannot set any parameter, except switching to be a master wired controller.
Master IDU	ON, OFF	OFF	After turning on this setting, the current indoor unit will be a master indoor unit. The icon of master indoor unit “  ” will be displayed on homepage. After turning off this setting, master and slave status of the current indoor unit remains unchanged.
Use Remote	ON, OFF	ON	When it is set “OFF”, wired controller cannot receive signals from remote controller.
Prior Operation	ON, OFF	OFF	When power supply is insufficient, indoor units set with operation priority can be turned off manually while other units will be shut down forcibly.
High Ceiling Installation*	ON, OFF	OFF	Only applicable to cassette type unit



## Wired Controller (XK86 and XE76-33/H)

Setting	Setting scope	Default	Remarks
Link with Fresh Air IDU*	ON, OFF	OFF	After this function is set, fresh air indoor units will be on and off with the on and off of other indoor units. However, they can also be turned on or off separately. Only applicable to fresh air indoor units.
In °F	ON, OFF	OFF	After turning on this setting, the temperature unit will be Fahrenheit. Otherwise, the temperature unit is Celsius.
Clear Filter Cleaning Time	Clear; Don't Clear	Don't Clear	—
Reset WiFi*	Reset; Don't reset	Don't reset	Only applicable to the unit connected to "G-Cloud".
IDU Fan Static Pressure	1~9	5	—
Number of IDUs	0: Disable this function; 1-16: Number of indoor units	1	Set a corresponding value according to the number of connected indoor units.
Angle of Air-return Board*	Angle 1 Angle 2 Angle 3	Angle 1	Only applicable to units with air return plate.
Cooling temp of Auto Mode	17°C~30°C (63°F~86°F)	25°C(77°F)	Cooling temperature of auto mode – Heating temperature of auto mode ≥1°C.
Heating temp of Auto Mode	16°C~29°C (61°F~84°F)	20°C(68°F)	

## Wired Controller (XK86 and XE76-33/H)

Setting	Setting scope	Default	Remarks
Cooling Temp of Fresh Air IDU*	16°C ~30°C (61°F~86°F)	18°C (64°F)	Only applicable to fresh air indoor units.
Heating Temp of Fresh Air IDU*	16°C ~30°C (61°F~86°F)	22°C (72°F)	Only applicable to fresh air indoor units.
Relative Humidity of Auto Dry*	65%~85%	75%	Only applicable to temperature-humidity dual-control duct type indoor unit
Relative Humidity of Absence*	65%~85%	75%	Only applicable to temperature-humidity dual-control duct type indoor unit
Temp of Absence Mode*	5~10°C (41°F~50°F)	8°C (46°F)	Only applicable to temperature-humidity dual-control duct type indoor unit
Resume After Inserting Card	Yes, No	Yes	When it is set as “No”, it will keep the status after inserting the gate control card, that is, if it is OFF status when pulling out the card, when inserting the card, it is still OFF status.
PM2.5 Filter*	On, Off	Off	When it is set as “On”, PM2.5 filter function is activated.
Time Setting for IDU Cold Air Prevention	180s 300s 420s 600s	180s	Cold air prevention time is the max waiting time from the time turning on the heating mode to the time blowing out the hot wind. The actual waiting time is related to the outdoor ambient temperature. If there is cold air after turning on the heating mode in the actual operation, please consult the professional person to adjust this parameter.

**NOTES:**

- ① Setting of parameters not listed above can only be accessed with password.
- ② Under the status of parameter setting, signals from remote controller are ineffective.

## 6 Operation Instructions

### 6.1 On/Off

Press "On/Off" button on homepage to turn on the air conditioner.

Press "On/Off" button again to turn it off.

The interfaces of ON and OFF are as shown in Fig.6.1 and 6.2.

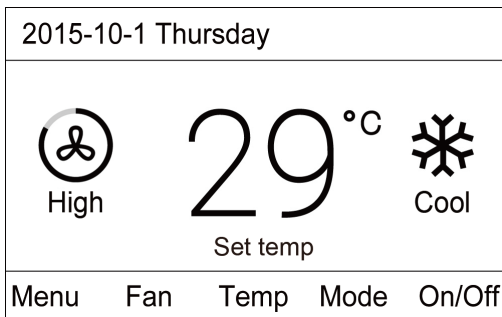

Fig.6.1 Interface of ON

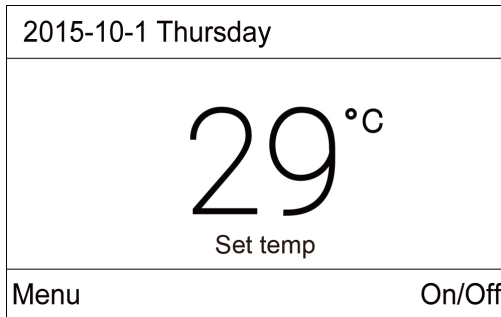

Fig. 6.2 Interface of OFF

## 6.2 Mode Setting

Under ON status, pressing "Mode" button on homepage can switch modes circularly in the following order:

Auto -> Cool- > Dry -> Fan -> Heat -> Floor Heat -> 3D Heat -> Space Heat -> Auto

If wired controller is connected to temperature-humidity dual-control duct type indoor unit, modes will be switched in the following order:

Cool -> Auto Dry -> Dry Reheat -> Fan -> Heat -> Absence -> Floor Heat -> 3D Heat->Cool

**NOTES:**

- ① Different models have different operating modes. Wired controller will select the types of mode automatically according to the models of indoor units.
- ② Only the master indoor unit in the master-slave mode can set up Auto mode (not applicable to heat recovery units).
- ③ Instructions on mode switch:
  - a) For heat recovery units, any one indoor unit can switch to different modes freely;
  - b) For multi-functional residential multi VRF units, if only one indoor unit has been turned on, this unit can switch to any mode; if multiple indoor units have been turned on, system mode will be the mode of the unit that is first turned on and other units cannot switch to a mode that is in conflict with system mode.
  - c) For other types of indoor unit, when the system mode priority is the master-slave mode, the operation mode of the system is basing on that of master indoor unit. Master indoor unit can switch to any modes, while slave unit can't switch to the mode that is conflicting with master indoor unit. When master indoor unit changes mode which cause operation mode of slave indoor unit conflicts with that of system, the operation mode of slave unit will switch to the operate mode of system automatically.

## 6.3 Temperature Setting

Under ON status, press "Temp" button on homepage to enter the interface of temperature setting, as shown below. Then press "▲" or "▼" button to increase or decrease temperature by 1°C. If you press and hold the buttons, temperature will be increased or decreased by 1°C in every 0.3 second. After setting the temperature, press "↩" button to return to homepage.

Under the mode of Cool, Dry Reheat, Fan, Heat, Floor Heat, 3D Heat and Space Heat, temperature setting range is 16°C~30°C.

Under Dry mode, temperature setting range is 12°C, 16°C~30°C. When unit is operating in drying mode and temperature is 16°C, pressing "▼" button twice can change the temperature to 12°C (If Save function for Cool is enabled, drying temperature cannot be set to 12°C and its setting range is "lowest temperature in Save mode" ~ 30°C).

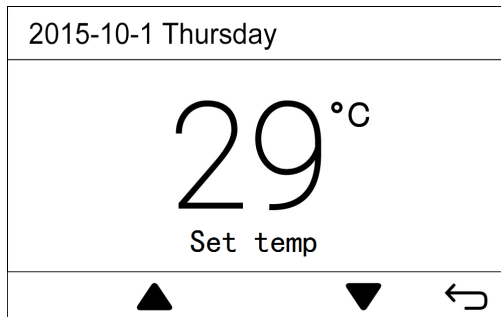

**NOTES:**

- ① After Absence function is enabled, pressing “▲” or “▼” button can not change the temperature.
- ② Under Auto mode, wired controller cannot enter the interface of temperature setting. You can set the cooling temperature and heating temperature of Auto mode in project parameter setting.
- ③ Under Auto Dry mode or Absence mode, homepage will not display set temperature and wired controller cannot enter the interface of temperature setting. Temperature can only be adjusted in project parameter setting.
- ④ Under Dry Reheat mode, you can enter the interface of temperature setting and set the temperature and relative humidity at the same time.
- ⑤ If wired controller is connected to fresh air indoor unit, homepage will not display set temperature. Temperature display zone will display the code of fresh air indoor unit "FAP". Wired controller cannot enter the interface of temperature setting. Cooling temperature and heating temperature can only be set in project parameter setting.
- ⑥ If wired controller is connected to temperature-humidity dual-control duct type indoor unit, pressing “▲” or “▼” button can increase or decrease temperature by 0.5°C.

## 6.4 Fan Setting

Under ON status, pressing "Fan" button on homepage can switch fan speed circularly in the following order:

Auto->Low->Medium Low->Medium->Medium High->High->Auto

**NOTES:**

- ① Under Dry or Auto Dry mode, low fan speed is set automatically. Fan speed cannot be adjusted.
- ② Under Absence mode, auto fan speed is set automatically. Fan speed cannot be adjusted.
- ③ If wired controller is connected to fresh air indoor unit, high fan speed is set automatically. Pressing "Fan" button cannot change the fan speed.
- ④ If auto fan speed is set, indoor unit will change fan speed automatically according to indoor ambient temperature.

## 6.5 Schedule Setting

Wired controller has two types of schedule setting: general schedule and periodical schedule.

Press "Menu" button on homepage and then select "Schedule" to enter the interface of schedule setting. As shown below, Schedule 1, 2, 3 refer to periodical schedule. Periodical schedule and general schedule can be enabled at the same time. Schedule function is turned on if "■" is displayed on the left. Schedule function is turned off if "□" is displayed.



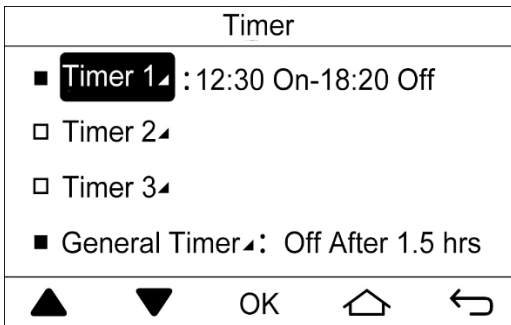

On the interface of schedule setting, press “▲” or “▼” button to switch to a different item. Press "OK" to enter the interface of the corresponding schedule setting.

### 6.5.1 General schedule

Under ON status, you can set General schedule to turn unit off. Under OFF status, you can set General schedule to turn unit on.

On the interface of schedule setting, select "General Schedule" to enter the setting of general schedule. As shown below, set schedule to turn unit on or turn unit off and set the schedule time. Press "OK" to save the schedule setting and return to the previous page.

Range of schedule time: 0.5~24 hours

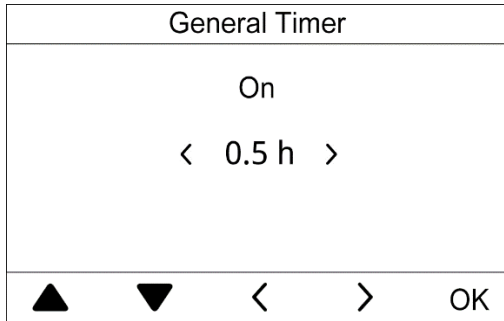

### 6.5.2 Periodical schedule

On the interface of schedule setting, select "Schedule 1" or "Schedule 2" or "Schedule 3" to enter the setting of periodical schedule. See below (take Schedule 1 as an example):

To ensure time accuracy, please check the current system date and time before setting the schedule. If date and schedule are wrong, please reset them on the interface of "Date & Time".

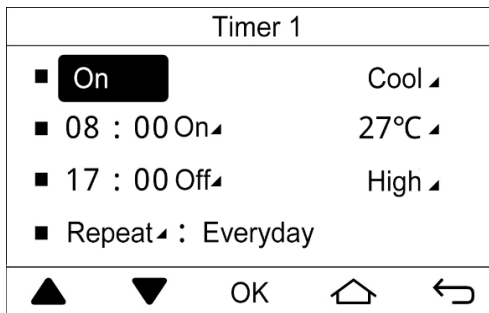

On the interface of Schedule 1, press “▲” or “▼” button to switch to a different item. Select the first item and press "OK" button to turn on or off Schedule 1. When selecting other items, press "OK" button to enter the interface of the corresponding setting.

Enter the interface of mode setting, temperature setting or fan speed setting to set up the mode, temperature or fan speed that unit is going to perform when it is turned on through schedule.

If you want to just turn unit on through schedule, set the time for unit ON. If you want to just turn unit off through schedule, set the time for unit OFF. If you want to turn unit on and off through schedule, set the time for unit ON and OFF. Below is the interface of setting time for unit ON. On the interface of setting time for unit ON or OFF, press. “▲” or “▼” button to switch to a different selection. Press “<” button or “>” button to switch between ON and OFF or to adjust time. Press "OK" button to save the setting and return to the previous page.

On Time				
< On >				
Hour : 12				
Minute : 30				
▲	▼	<	>	OK

On the interface of Schedule 1, select "Repeat" to enter the following interface, where you can set the days for schedule to be effective. Press "▲" or "▼" button to switch to a different selection. Press "OK" button to confirm or cancel the corresponding selection. Press "↶" button to save the setting and return to the previous page.

Timer-Repeat				
<input type="checkbox"/> Everyday	<input checked="" type="checkbox"/> Thursday			
<input checked="" type="checkbox"/> Monday	<input checked="" type="checkbox"/> Friday			
<input checked="" type="checkbox"/> Tuesday	<input type="checkbox"/> Saturday			
<input checked="" type="checkbox"/> Wednesday	<input type="checkbox"/> Sunday			
▲	▼	OK	↶	

**NOTES:**



- ① Schedule function cannot be set in Absence mode.
- ② If the time format is set as 12 hour-clock, the time in all schedule pages will be displayed in 12-hour clock with an AM/PM indicator.



## 6.6 Function Setting

Select "Function" on Menu page to enter the interface of function setting as shown below.

Press “▲” or “▼” button to to switch among different items. Press "OK" button to turn on or off the corresponding function. “■” showing on the left means the corresponding function is ON while “□” means OFF. Press "PgUp" or "PgDn" to switch to a previous page or a next page. Press "←→" button to save the setting and return to the previous page.

When selecting the item with “▲” (Quiet, U&D Swing Position, L&R Swing Position, Air, Clean, Save), press "OK" button to enter the setting interface of the corresponding function.

Function		1/2
<input checked="" type="checkbox"/> Up & Down Swing	<input type="checkbox"/> Sleep	<input type="checkbox"/> Lock
<input checked="" type="checkbox"/> Left & Right Swing	<input checked="" type="checkbox"/> Light	<input type="checkbox"/> Rapid
<input type="checkbox"/> Quiet	<input checked="" type="checkbox"/> Absence	<input type="checkbox"/> X-fan
		OK PgDn 

Function		2/2
<input type="checkbox"/> U&D Swing Position	<input checked="" type="checkbox"/> Air	<input checked="" type="checkbox"/> Clean
<input type="checkbox"/> L&R Swing Position	<input checked="" type="checkbox"/> Save	<input type="checkbox"/> Health
<input type="checkbox"/> 12-Drying	<input checked="" type="checkbox"/> E-heater	<input type="checkbox"/> Turbo
		OK PgUp 

**NOTES:**

- ① Sometimes, some functions may be invalid. Invalid functions are displayed in grey. Press “▲” or “▼” button will skip the invalid function.
- ② After Child lock function is ON, wired controller will be back to the homepage and buttons will be invalid. Unlock the wired controller according to the hint and buttons will be valid again.

**Introduction of functions:**

**Sleep:** Indoor unit runs in sleep mode after this function is ON. Unit will run based on a preset temperature curve in order to provide a comfortable sleeping environment for users. Sleep function can be enabled in Cool, Dry, Heat, 3D Heat or Space Heat mode.

**Lock:** Buttons are invalid after this function is ON. User needs to unlock according to the hint given by the wired controller.

**Light:** This function can control the ON and OFF of indoor unit lamp board.

**Rapid\*:** This is used to raise or lower temperature to a set value quickly upon startup. Rapid function can be enabled only in Cool mode or Heat mode.

**Absence:** This is used to maintain indoor temperature so that unit can perform heating quickly upon startup. Absence function can be enabled only in Heat mode. If wired controller is connected to temperature-humidity dual-control duct type indoor unit, Absence function cannot be used.

**X-fan:** This is used to dry indoor evaporator after unit is turned off to avoid mildew. X-fan function can be enabled only in Cool or Dry mode.

**Health\*:** This is used to turn on or off Health function.

**12-Drying:** This function can be enabled in Dry mode. After this function is ON, set temperature of Dry mode turns to 12°C.

**Turbo:** This is used to turn on the highest fan speed. After this function is ON, Turbo will be displayed on the homepage.

## 6.6.1 Setting of Swing Position

### (1) U&D Swing Position\*:

On the function interface, select "U&D Swing Position" to enter the setting of up and down swing position, as shown below:

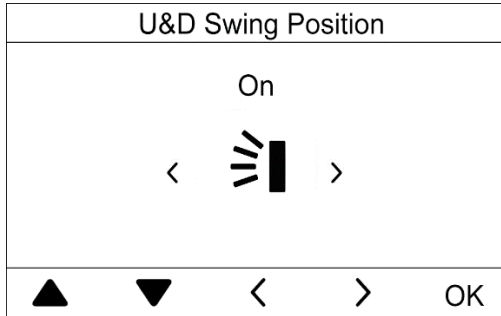

Press “▲” or “▼” button to switch to a different selection. When selecting the first item, press “<” or “>” to select ON or OFF. When selecting the icon of air swing, press “<” or “>” to switch to a different swing angle. The icon of air swing will be displayed in the following order:

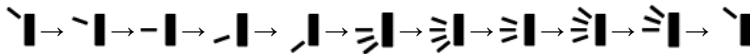

Press "OK" to save the setting and return to the previous page.



### (2) L&R Swing Position\*:

On the function interface, select "L&R Swing Position" to enter the setting of left and right swing position, as shown below:

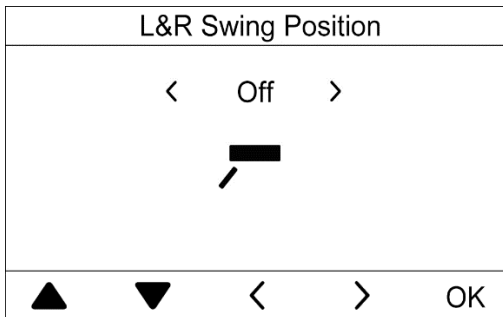

Press “▲” or “▼” button to switch to a different selection. When selecting the first item, press “<” or “>” to select ON or OFF. When selecting the icon of air swing, press “<” or “>” to switch to a different swing angle. The icon of air swing will be displayed in the following order:

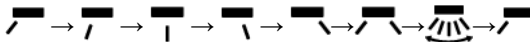

Press "OK" to save the setting and return to the previous page.

## 6.6.2 Setting of Quiet Function

Quiet: This is used to reduce indoor unit noise. Quiet function includes Quiet mode and Auto Quiet mode. Quiet function can be enabled in Auto mode, Cool mode, Dry mode, Auto Dry mode, Dry Reheat mode, Fan mode, Heat mode, 3D Heat mode

and Space Heat mode.

On the function interface, select "Quiet" to enter the setting of Quiet function, as shown below:

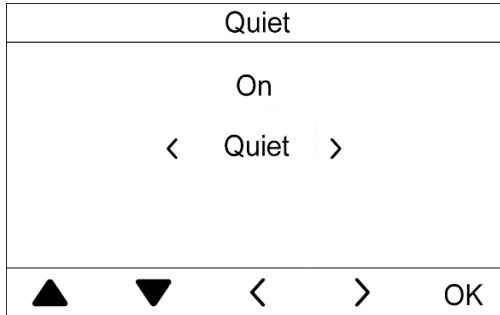

Press “▲” or “▼” button to switch to a different selection. When selecting the first item, press “<” or “>” to select ON or OFF. When selecting the second item, press “<” or “>” to switch between "Quiet" and "Auto Quiet". Press "OK" to save the setting and return to the previous page.

**NOTES:**

- ① When Quiet mode is ON, indoor unit will run at a quiet fan speed. Fan speed is lowered to reduce noise of indoor unit.
- ② When Auto Quiet mode is ON, indoor unit will change fan speed based on room temperature. When room temperature reaches a set value, unit will run at a quiet fan speed.

### 6.6.3 Setting of Air Function\*

Air: This is used to adjust the fresh air volume indoors to improve air quality.

On the function interface, select "Air" to enter the setting of Air function, as shown below:

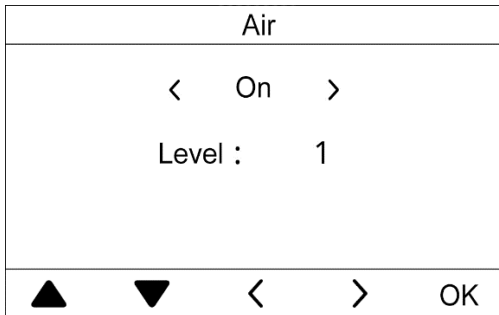

Press “▲” or “▼” button to switch to a different selection. When selecting the first item, press “<” or “>” to select ON or OFF. When selecting the second item, press “<” or “>” to switch to a different air degree. The range of air level is 1~10. Press "OK" to save the setting and return to the previous page.

#### NOTES:

- ① Air function is applicable only to units with air function and installed with fresh air electric valve (fresh air valve in short).
- ② Air level is related to the opening time of fresh air valve in a certain time (60 minutes). Please see the table below. Opening time of fresh air valve indicates the first N minutes within a certain time. For example: if air degree

is set to 1, unit starts to count the time and fresh air valve is open. 6 minutes later, fresh air valve is closed while unit continues operating. When the unit counts to 60 minutes, it will restart counting and fresh air valve is open. 6 minutes later, fresh air valve is closed. Unit operates circularly like this.

level	1	2	3	4	5	6	7	8	9	10
Opening time of fresh air valve	60/6	60/12	60/18	60/24	60/30	60/36	60/42	60/48	60/54	Open all the time
NOTE: Above time indicates unit operating time (min) / fresh air valve opening time(min)										

#### 6.6.4 Setting of Save Function

Save: This is used to set the lower limit of set temperature in Cool mode, Dry mode and Dry Reheat mode and the upper limit of set temperature in Heat mode, 3D Heat mode and Space Heat mode. Air conditioner operates within a smaller temperature range to realize energy saving.

On the function interface, select "Save" to enter the setting of power saving function, as shown below:

Save				
On				
Mode: Cool				
Lower Temp Limit: < 27°C >				
▲	▼	<	>	OK

Press “▲” or “▼” button to switch to a different selection. When selecting the first item, press “<” or “>” to select ON or OFF. When selecting the second item, press “<” or “>” to switch to a different mode. When selecting the third item, press “<” or “>” to set the upper or lower limit of temperature. Press "OK" to save the setting and return to the previous page.

If Save function is ON under Cool mode, Dry mode or Dry Reheat mode, set temperature displayed on homepage cannot be lower than the lower limit of temperature set in Save function. If Save function is ON under Heat mode, 3D Heat mode and Space Heat mode, set temperature displayed on homepage cannot be higher than the upper limit of temperature set in Save function.

### 6.6.5 Setting of Filter Clean Reminder

Filter Clean Reminder: Air conditioner can record its running time and when it reaches to a certain time, unit can remind user to clean filter. A dirty filter will cause poor cooling and heating effect, malfunction or even generate bacteria.

On the function interface, select "Clean" to enter the setting of filter cleaning reminding function, as shown below:

Clean				
On				
Current Cleanliness:		A		
Clean Cycle: <		5	>	
▲	▼	<	>	OK

Press "▲" or "▼" button to switch to a different selection. When selecting the first item, press "<" or ">" to select ON or OFF. When selecting the second item, press "<" or ">" to switch to a cleaning degree of the current environment (A, B, C). When selecting the third item, press "<" or ">" to adjust the clean cycle. The range of filter clean cycle is 0~9. Press "OK" to save the setting and return to the previous page.

Filter cleaning reminding time is related to the cleaning degree of current environment and the clean cycle. There are 4 types of filter cleaning condition:

- (1) Filter cleaning reminder is OFF;
- (2) Light pollution: Cleaning degree of current environment is "A". When clean cycle is "0", the accumulative running time is 5500 hours. Every increase of "1" indicates an increase of 500 hours in running time. When clean cycle is "9", the accumulative running time is 10000 hours;
- (3) Medium pollution: Cleaning degree of current environment is "B". When clean cycle is "0", the accumulative running time is 1400 hours. Every increase of "1" indicates an increase of 400 hours in running time. When clean cycle is "9", the accumulative running time is 5000 hours;
- (4) Severe pollution: Cleaning degree of current environment is "C". When clean cycle is "0", the accumulative running time is 100 hours. Every increase of "1" indicates an increase of 100 hours in running time. When clean cycle is "9", the accumulative running time is 1000 hours;

### **NOTE:**

When cleaning time is up, icon  will be displayed on status bar and a reminder box will pop up on homepage to remind user. Press "Done" or "Ignore" to cancel the display. Meanwhile, the accumulative time for "Filter clean reminder" is reset and starts counting again.

## 6.7 Service Hotline Query

On the View interface, select "Hotline" to enter the query and setting of aftersales hotline. See below:

Aftersales Tel	
Tel 1 :	12345678 Clear
Tel 2 :	Set First
	

If aftersales Tel is not set, it won't be displayed. The number will only be displayed after an aftersales Tel is set. Select "Set First" or phone number, then press "OK" to enter the next page to set up the phone number.

After the phone number is set, select "Clear" to clear the corresponding phone number.

**NOTE:** Two phone numbers can be set as the aftersales phone number. This is to help user to quickly search for a service number and contact local aftersales office for timely assistance.



## 6.8 Language Setting

On the Set interface, select "Language" to enter the setting of language. You can select Chinese or English.

## 6.9 Sound Setting

On the Set interface, select "Sound" to enter the setting of sound. You can turn on or off the sound of button touch.



## 6.10 Date and Time Setting

On the Set interface, you can select "Date & Time" to set the date and time.



## 6.11 Remote Shield Function

Remote Shield Function: Remote monitor or central controller can disable the relevant functions of wired controller so as to realize the function of remote control.

Remote Shield Function includes all shield and partial shield. When All Shield function is on, all controls of the wired controller are disabled. When Partial Shield function is on, those controls that are shielded will be disabled.

When the remote monitor or central controller activates Remote Shield on the wired controller, “” icon will show. If user wants to control through the wired controller, “” icon will blink to remind that these controls are disabled.

## 6.12 Gate-control Function

When there is Gate-control System, user can insert a card to turn on the unit or pull off a card to turn off the unit. When the card is re-inserted, the unit will recover the operation as state in memory. When the card is pulled off (or improperly inserted), “” icon will show, neither remote control nor operation of wired controller will be effective and icon “” will be flickering.

**NOTE:** This model cannot be connected with gate control system on its own because it cannot detect gate control signal directly. To realize gate control display and gate control function, it has to be used with wired controller that includes gate control signal detecting function (used as master and slave wired controller).

## 6.13 Inquiry of Indoor Temperature with One Button

In the homepage, after pressing and holding “Menu” button for 5 seconds, the wired controller will display the indoor environment temperature for 5 seconds. Within the 5 seconds, it can quit displaying the indoor temperature immediately and be responded to the instructions as usual after pressing any buttons.

## 7 Error Display

If malfunction occurs when system is running, wired controller will display error icon “”, error code and project number of the corresponding indoor unit. If multiple malfunctions occur at the same time, error codes will be displayed circularly.

**NOTE:** If error occurs, please turn off the unit and send for professionals to repair.

## 7.1 Table of Error Codes for Outdoor Unit

Error Code	Content	Error Code	Content
E0	Outdoor Unit Error	J9	System Pressure Under-Ratio Protection
E1	High Pressure Protection	JA	Protection of Abnormal Pressure
E2	Discharge Low Temperature Protection	JC	Protection of Water Flow Switch
E3	Low Pressure Protection	JL	Protection of Low High-pressure
E4	Excess Discharge Temperature Protection of Compressor	JE	Oil Return Pipe is Blocked
Ed	Low Temperature Protection of Driver Module	JF	Oil Return Pipe is Leaking
F0	Bad Performance of the Outdoor Mainboard	JJ	Low Water-in Temperature Protection
F1	High Pressure Sensor Error	b1	Outdoor Ambient Temperature Sensor Error
F2	Inlet Tube Temperature Sensor Error of Plate Type Heat Exchanger	b2	Defrosting Temperature Sensor 1 Error
F3	Low Pressure Sensor Error	b3	Defrosting Temperature Sensor 2 Error
F4	Outlet Tube Temperature Sensor Error of Plate Type Heat Exchanger	b4	Subcooler Liquid-out Temperature Sensor Error

Wired Controller (XK86 and XE76-33/H)

Error Code	Content	Error Code	Content
F5	Compressor 1 Discharge Temperature Sensor Error	b5	Subcooler Gas-out Temperature Sensor Error
F6	Compressor 2 Discharge Temperature Sensor Error	b6	Gas-liquid Separator Inlet Temperature Sensor Error
F7	Compressor 3 Discharge Temperature Sensor Error	b7	Gas-liquid Separator Outlet Temperature Sensor Error
F8	Compressor 4 Discharge Temperature Sensor Error	b8	Outdoor Humidity Sensor Error
F9	Compressor 5 Discharge Temperature Sensor Error	b9	Heat Exchanger Gas-out Temperature Sensor Error
FA	Compressor 6 Discharge Temperature Sensor Error	bA	Oil-return Temperature Sensor Error
FC	Compressor 2 Current Sensor Error	bH	System Clock Malfunction
FL	Compressor 3 Current Sensor Error	bE	Malfunction of Entry Tube Temperature Sensor of Condenser
FE	Compressor 4 Current Sensor Error	bF	Malfunction of Exit Tube Temperature Sensor of Condenser
FF	Compressor 5 Current Sensor Error	bJ	High and Low Pressure Sensors are Connected Inversely
FJ	Compressor 6 Current Sensor Error	bP	Oil-return 2 Temperature Sensor Error
FP	Malfunction of DC motor	bU	Oil-return 3 Temperature Sensor Error
FU	Compressor 1 Top Temperature Sensor Error	bb	Oil-return 4 Temperature Sensor Error
Fb	Compressor 2 Top Temperature Sensor Error	bd	Air-in Temperature Sensor Error of Subcooler

## Wired Controller (XK86 and XE76-33/H)

Error Code	Content	Error Code	Content
Fd	Mode Exchanger Outlet Pipe Temperature Sensor Error	bn	Liquid-in Temperature Sensor Error of Subcooler
Fn	Mode Exchanger Inlet Pipe Temperature Sensor Error	by	Water-out Temperature Sensor Error
Fy	Water-in Temperature Sensor Error	P0	Compressor Drive Board Error
J1	Compressor 1 Over-current Protection	P1	Compressor Drive Board Malfunction
J2	Compressor 2 Over-current Protection	P2	Protection of Compressor Drive Board Power Supply
J3	Compressor 3 Over-current Protection	P3	Protection of Compressor Drive Board Module Reset
J4	Compressor 4 Over-current Protection	H0	Error of Fan Drive Board
J5	Compressor 5 Over-current Protection	H1	Malfunction of Fan Drive Board
J6	Compressor 6 Over-current Protection	H2	Protection of Fan Drive Board Power Supply
J7	4-way Valve Blow-by Protection	GH	PV DC/DC Protection
J8	System Pressure Over-Ratio Protection	—	—

## 7.2 Table of Error Codes for Indoor Unit

Error Code	Content	Error Code	Content
L0	Indoor Unit Error	dL	Outlet Air Temperature Sensor Error

Wired Controller (XK86 and XE76-33/H)

Error Code	Content	Error Code	Content
L1	Indoor Fan Protection	dE	Indoor Unit CO <sub>2</sub> Sensor Error
L2	E-heater Protection	db	Special Code: Field Debugging Code
L3	Water Full Protection	dn	Swing Assembly Error
L4	Wired Controller Power Supply Error	dy	Water Temperature Sensor Error
L5	Anti-Frosting Protection	y1	Inlet Pipe Temperature Sensor 2 Error
L6	Mode Conflict	y2	Outlet Pipe Temperature Sensor 2 Error
L7	No Master Indoor Unit Error	y3	Middle Tube Temperature Sensor 2 Error
L8	Power Insufficiency Protection	y7	Fresh Air Inflow Temperature Sensor Error
L9	Quantity Of Group Control Indoor Units Setting Error	y8	Indoor Air Box Sensor Error
LA	Indoor Units Incompatibility Error	y9	Outdoor Air Box Sensor Error
LH	Low Air Quantity Warning	yA	IFD error
LC	Outdoor-Indoor Incompatibility Error	yH	Fresh Air-out Sensor Error
LF	Shunt Valve Setting Error	yC	Air-return Inlet Sensor Error
LJ	Wrong Setting of Function DIP Switch	yL	Air-return Outlet Temperature Sensor Error
LP	Zero-crossing Malfunction of PG Motor	yE	High Liquid Level Switch Error

## Wired Controller (XK86 and XE76-33/H)

Error Code	Content	Error Code	Content
LU	Inconsistent Branch of Group-controlled Indoor Units in Heat Recovery System	yF	Low Liquid Level Switch Error
Lb	Inconsistency of Group-controlled Indoor Units in Reheat Dehumidification System	o0	Motor Drive Error
Ld	Indoor Fan 2 Error	o1	Low Voltage of IDU Bus Bar
Ln	Lift Panel Return Air Frame Reset Exception	o2	High Voltage of IDU Bus Bar
d1	Indoor Unit PC-Board Error	o3	IDU IPM Module Protection
d3	Ambient Temperature Sensor Error	o4	IDU Startup Failure
d4	Inlet Pipe Temperature Sensor Error	o5	IDU Overcurrent Protection
d5	Malfunction of Middle Tube Temperature Sensor	o6	IDU Current Detective Electric Circuit Error
d6	Outlet Pipe Temperature Sensor Error	o7	IDU Losing Step Protection
d7	Humidity Sensor Error	o8	IDU Driver Communication Error
d8	Water Temperature Abnormality	o9	Communication Error of IDU Master Controller
d9	Jumper Cap Error	oA	High Temperature of IDU Module
dA	Indoor Unit Hardware Address Error	oC	IDU Charging Circuit Error
dH	Wired Controller PC-Board Error	ob	Temperature Sensor Error of IDU Module
dC	Capacity DIP Switch Setting Error	—	—

### 7.3 Table of Debugging Codes

Error Code	Content	Error Code	Content
U2	Outdoor Unit Capacity Code/Jumper Cap Setting Error	C0	Communication between indoor unit and outdoor unit and the communication between indoor unit and wired controller have malfunction
U3	Phase Sequence Protection of Power Supply	C1	Communication error of expansion board
U4	Protection of Lack of Refrigerant	C2	Communication error between master control and inverter compressor drive
U5	Wrong Address of Compressor Drive Board	C3	Communication error between master control and inverter fan motor drive
U6	Valve Abnormal Alarm	C4	Error of Lack of Indoor Unit
U7	Grid DRED0 Response Protection	C5	Alarm of Indoor Unit Project Number Collision
U8	Indoor Unit Tube Malfunction	C6	Alarm of Wrong Number of Outdoor Unit
U9	Outdoor Unit Tube Malfunction	C7	Mode Exchanger Communication Error
UA	Overvoltage Protection of DC Bus Bar in Power Grid Side	CH	Rated capacity is too high
UH	Undervoltage Protection of DC Bus Bar in Power Grid Side	CC	No master control unit error



## Wired Controller (XK86 and XE76-33/H)

Error Code	Content	Error Code	Content
UC	Master indoor unit is successfully set	CL	Rated capacity is too low
UL	Emergency Operation DIP switch setting of the compressor is wrong	CE	Communication Failure Between Mode Exchanger and Indoor Unit
UE	Refrigerant Charging is ineffective	CF	Error of Multiple Master Indoor Unit
UF	Indoor Unit Identification Error of Mode Exchanger	CJ	System addresses is incompatible
UJ	PV module F0 protection	CP	Error of Multiple Master Wired Controller
UP	Protection shutdown error of thermal storage module	CU	Communication Error between Indoor Unit and Remote Receiver
UU	Electronic expansion valve leak error of thermal storage module	Cb	Outflow of Units IP Address
Ub	Protection without shutdown error of thermal storage module	Cd	Communication Failure Between Mode Exchanger and Outdoor Unit
Ud	Grid-connection driver board error	Cn	Indoor and Outdoor Network Error of Mode Exchanger
Un	Communication error between grid-connection driver board and master controller	Cy	Communication Error of No Master in Mode Exchanger
Uy	PV module overheating protection	—	—

## 7.4 Table of Status Codes

Error Code	Content	Error Code	Content
A0	Unit is waiting for debugging	Ay	Shielding status
A1	Check the compressor operation parameters	n3	Compulsory defrosting
A2	After-sales Refrigerant Reclaim	q5	Setting of ordinary units and high sensible heat units
A3	Defrosting	q7	Select degree Celsius or Fahrenheit
A4	Oil return	q8	Discharge low temperature protection revision value b
A5	Online Testing	q9	Setting of defrosting mode
A8	Vacuum-pumping Mode	qL	Setting of static pressure
A9	Operate in Setback Function	qE	EVI Operating Mode
AH	Heating	qF	System compulsory cooling mode
AC	Cooling	qP	PV GMV Unit export area setting
AF	Fan	qU	Grid voltage system configuration
AJ	Filter Clean Reminder	qb	Anti-condensation temperature setting
AU	Remote Urgent Stop	qd	Setting of target degree of super-cooling of ODU
Ab	Emergency Stop	qn	PV grid-connected settings
Ad	Operation Restriction	qy	Working mode of compressor heating belt
An	Lock status	—	—



GREE ELECTRIC APPLIANCES, INC. OF ZHUHAI

Add: West Jinji Rd, Qianshan, Zhuhai, Guangdong, China, 519070

Tel: (+86-756) 8522218

Fax: (+86-756) 8669426

E-mail: [gree@gree.com.cn](mailto:gree@gree.com.cn) [www.gree.com](http://www.gree.com)



66170050102