



# G-MV<sup>IV</sup>

GREE MULTI VARIABLE

DC Inverter VRF Air Conditioning System



GREE ELECTRIC APPLIANCES, INC. OF ZHUHAI

Add: West Jinji Rd, Qianshan, Zhuhai 519070, Guangdong, China  
Tel: (+86-756) 8522218 Fax: (+86-756) 8669426  
Email: gree@gree.com.cn Http://www.gree.com

For continuous improvement in the products, GREE reserves the right to modify the product specification and appearance in this manual without notice and incurring any obligations.

Copyright © 2010 Gree Electric, inc. of zhuhai. All rights reserved.



# COMPANY PROFILE



## No.1 Air Conditioner Manufacturer in The World

GREE Electric Appliances, Inc. of Zhuhai, founded in 1991, is the world's largest air conditioner enterprise integrating R&D, manufacturing, marketing and services.

Through 20 years of development, we have vertically integrated all production value chain, producing key components such as compressor, motor, tooling mold, heat exchanger and capacitor.

Our products are classified into 20 categories, with 400 series, and 7,000 models. Thanks to more than 100 million users' choices, our products have been sold to about 100 countries and regions. We have topped No.1 in both domestic and overseas market since 1995 and 2005.

We have 6 production bases in Zhuhai, Chongqing, and Hefei (China), as well as Brazil, Pakistan and Vietnam, with annual production capacity of 27 million sets of residential air conditioners and 2 million sets of commercial air conditioners.

Gree enjoys a sound reputation for its products quality and performance. In China, we are the only air-conditioner brand ranked as a "World Brand" by the General Administration of Quality Supervision, "Top 100 Chinese Listed Companies", inspection and quarantine. In addition, it has been ranked among the "Top 100 Chinese Listed Companies" by "Fortune" for 8 consecutive years.

From "Made in China" to "Created in China", Gree, Making Better Air Conditioner!

GREE ELECTRIC APPLIANCES, INC. OF ZHUHAI

## CONTENTS

### GMV Evolution

#### Features

05-06	Higher Efficiency
07-08	Better Comfort
09-10	Higher Reliability
11-12	Better Versatility
13-14	Easy Installation & Maintenance
15-16	GMV Mini

#### Outdoor Units

17-18	Lineup
19-22	Specifications

#### Indoor Units

23-24	Lineup
25-28	Duct Type
29-30	Slim Duct Type
31-34	Four-way Cassette Type
35-36	One-way Cassette Type
37-38	Wall Mounted Type
39-42	Floor Ceiling Type
43-44	Treated Fresh Air Duct Type

#### Control System

45-46	Control Network Sketch
47	Controllers Comparison
48	Comments of Control Functions
49-50	Wired Remote Controller
51-52	Wireless Remote Controller
53	Group Controller
54	Smart Zone Controller
55	Centralized Controller
56	IR Receiver & Key-card Control Broad
57	Communication Module
58	Commissioning Program
59	RS-422/485 Repeater
60	RS-232 to RS-422/485 Converter
61-62	GREE AC Eudemon 2009 PC SUIT
63-64	Piping Design Program (GMV Selector)

#### 65-67 Energy Recovery Ventilation

68	Connection Branches
----	---------------------

# GMV IV EVOLUTION

## GREE Multi Variable DC Inverter VRF Air Conditioning System with R410A for Commercial & Residential Buildings

- **A**dvanced Control Functions
- **B**etter Reliability
- **C**ompact Outdoor Unit Design
- **D**C Inverter Scroll Compressor
- **E**CO-friendly R410A Refrigerant
- **F**lexible Piping Design
- **G**reatly Improved Energy Efficiency
- **H**igher Capacity up to 180kW(64HP)



**GMV IV 2007~2009**

4<sup>th</sup> Generation of GREE VRF System with DC Inverter Technology, highly improved efficiency and reliability, with a largest combination of 64HP.



**GMV III 2005~2006**

3<sup>rd</sup> Generation of GREE VRF System with DC Inverter Scroll Compressor, big capacity and modular technology provides the large combination of 42HP.



**GMV II 2000~2005**

2<sup>nd</sup> Generation of GREE VRF System with DC Inverter Compressor, high efficient R410A Eco-friendly refrigerant was applied in 2005.



**GMV 1998~2000**

1<sup>st</sup> Generation of GREE VRF System with AC Inverter Control Technology, up to 10HP.



# HIGHER EFFICIENCY

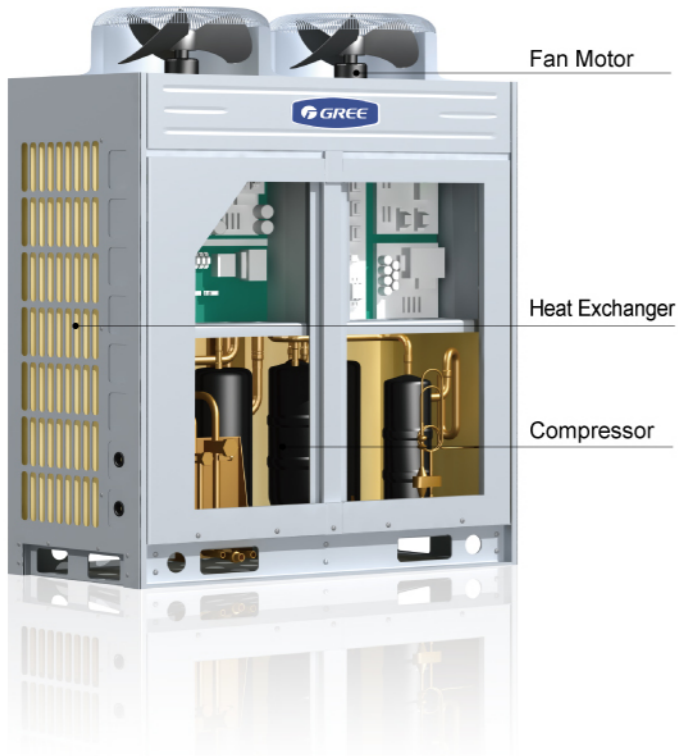

## Significantly improved EER/COP

Significantly greater efficiency is realized by the use of **DC Inverter Hermetic Scroll Compressors** with high pressure chamber design, and improved DC inverter driving technology, and large heat exchanger.

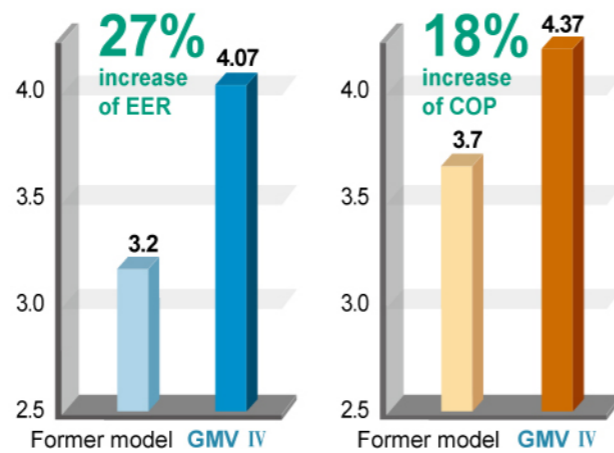

Note:

- EER is the efficiency rate = cooling capacity (kW) ÷ cooling power input (kW)
- COP is the coefficient of performance = heating capacity (kW) ÷ heating power input (kW)
- EER/COP values are based on GREE laboratory testing method.
- The data refers to a 8HP outdoor unit.

## DC Fan motor

Compared with the former model, air flow volume increases by **3%** with the same single fan and **7%** with the new dual fan, but the power consumption decreases by **5%** with the DC inverter motor.

### ► 8HP / 10HP Models

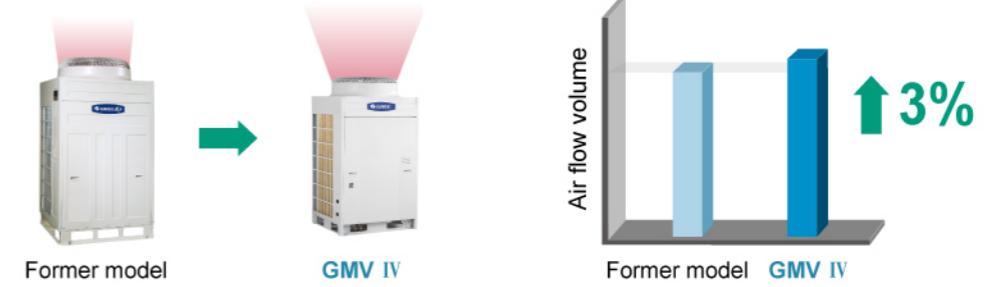

### ► 12HP / 14HP Models



## Heat exchanger

► The bigger condenser increases heat-exchange area, improving efficiency.



► Compared with the normal fin, the heat exchange efficiency of the louver fin is increased by **5%**.



► Special thickened inner groove copper tube enhances heat exchanging performance.

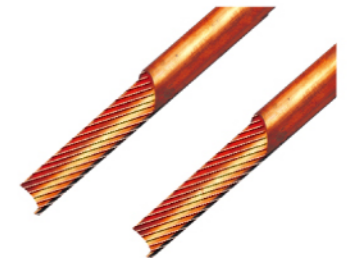

## High efficiency compressor

► High pressure chamber design

### What's High Pressure Chamber?

Compressed gas discharged from the fix scroll full fills the whole hermetic chamber of compressor, then goes out from the exhaust, that the whole compressor shell is high temperature and the pressure inside the compressor chamber is high.

### What's the benefit of High Pressure Chamber?

High pressure chamber compressor direct suction, no overheat suction loss, increase compressor efficiency by 3%~5%.

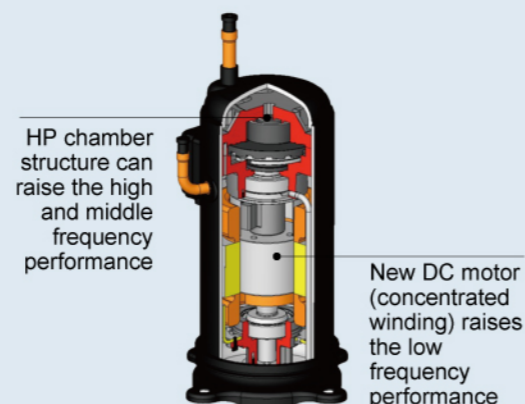
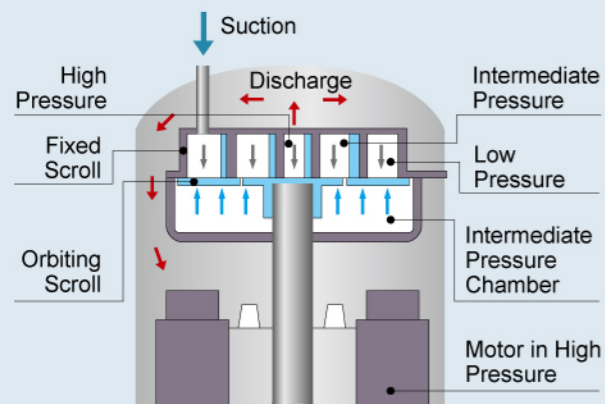

► Comparing with normal compressor, the DC Inverter Scroll Compressor can save up to **40%** of energy consumption in a year.

► With stepless power regulating technology, the DC inverter compressor achieves stepless output regulation between **20Hz-120Hz**.

► Improved DC inverter motor

Low frequency performance is highly raised thanks to the concentrated winding.

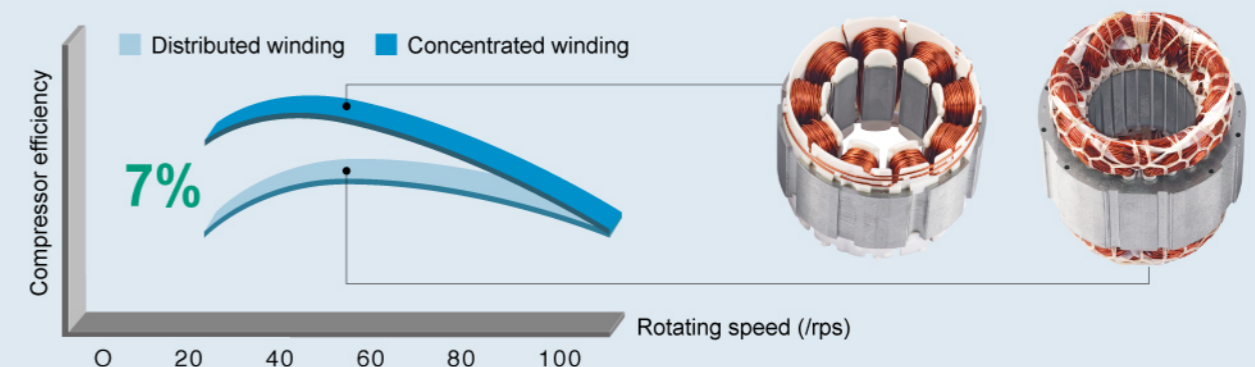

# BETTER COMFORT



## Quiet operation

### ► Quiet operation during night time

Intelligently adjustment of outdoor fan control can minimize the operation noise during night time. Up to **8dB(A)** can be reduced and operating noise at night low to **50dB(A)**.

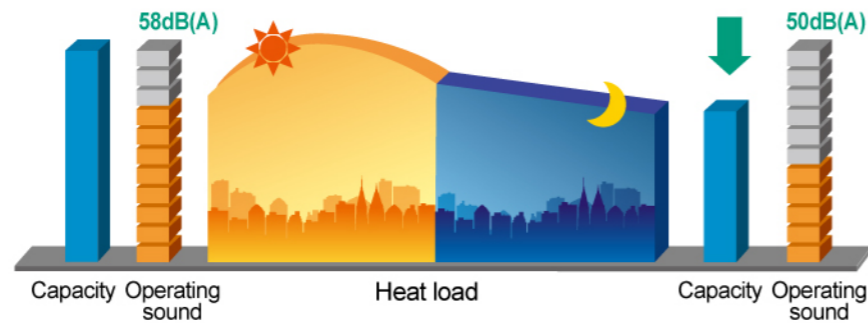

### ► Low noise design

#### OUTDOOR UNIT

- HP chamber compressor has lower exhaust pressure fluctuation so that noise is lower.
- The optimized design of condensing fan blade reduces the air flow turbulence among blades, so that the noise is lower.

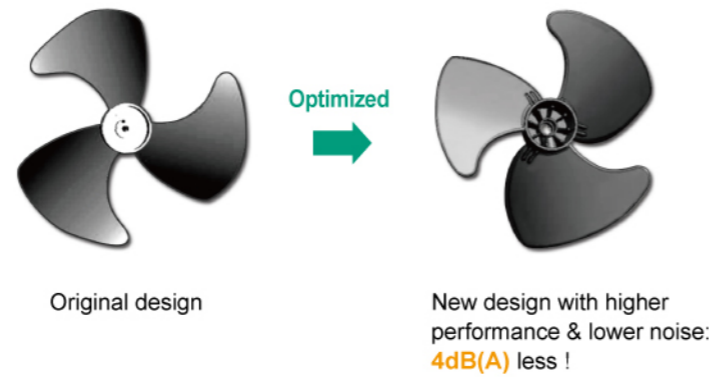
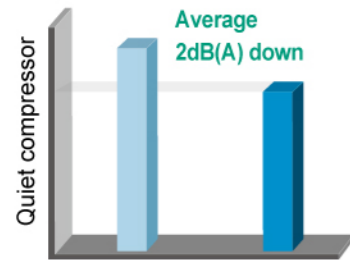

#### INDOOR UNIT

##### Low noise indoor unit

 <b>37dB(A)</b> Office Duct Type with High ESP	 <b>37dB(A)</b> Meeting Room Four-way Cassette Type
 <b>37dB(A)</b> Hotel Slim Duct Type	 <b>28dB(A)</b> Bedroom Wall Mounted Type

## Comfortable

### ► Precise temperature control

The EXV (Electronic Expansion Valve) of each Indoor unit respond to the loading changes of indoor environment, and continually adjusts the flow rate of the refrigerant.

Meanwhile, the outdoor unit with DC inverter compressor provides the capacity with certain amount of refrigerant exactly according to the total demands of indoor units.

With this Variable Refrigerant Flow (VRF) technology, we can quickly get a nearly constant room temperature without the typical temperature fluctuation that occurs with a conventional ON/OFF control system.

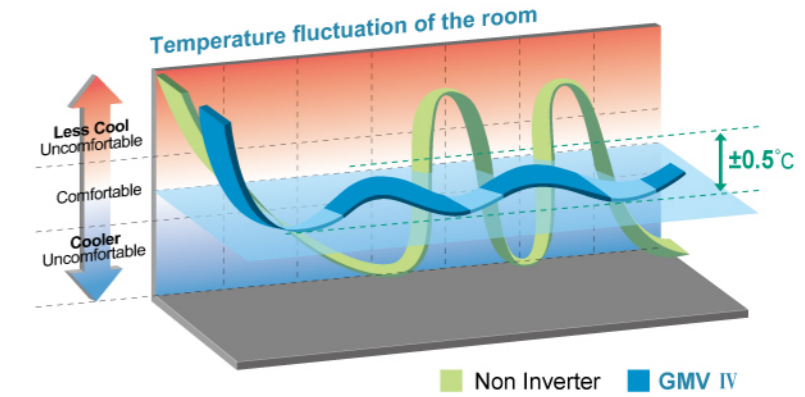

### ► Intelligent defrost technology

#### Traditional defrost program

- Simply execute defrosting according in a certain time.
- The defrost function may still starts even there is no such (defrosting) demand.

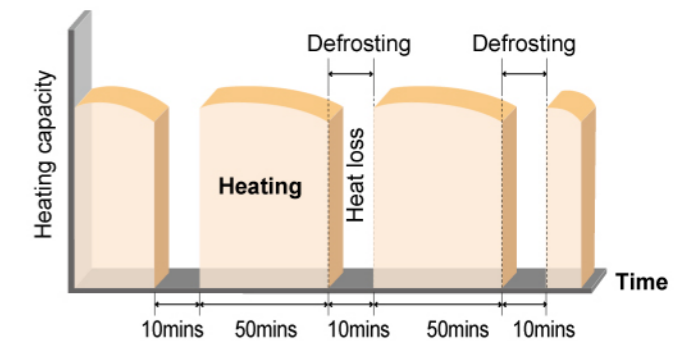

#### Intelligent defrost program

- Humanized technology which considers the maximization of energy saving.
- Defrosting program is designed under the consideration of heating efficiency and operation reliability.
- Precise defrosting timing, which is intelligent in deed.
- It's an optimized defrosting program, which will be performed only when system pressure is too low, that can obviously lengthen the time gap between two defrost operations, reduce the times of defrosting.
- Heating capacity loss has been decreased by **75%** with highly comfortable heating operation.

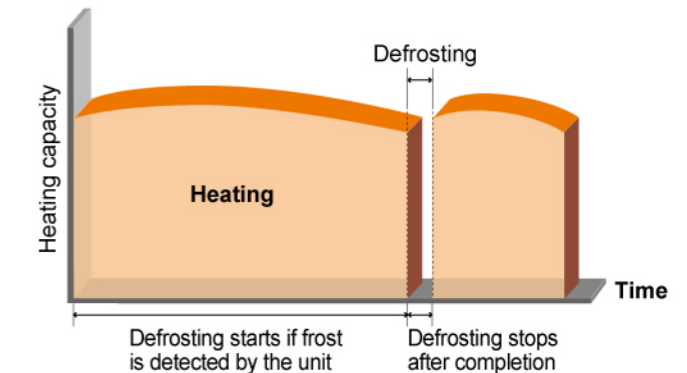

### ► Individual control

The set temperature of each room are may vary by the individual thermostat control of each indoor unit.



# HIGHER RELIABILITY



## Modular operating

► The operating priority sequence of the outdoor unit modules will be changed without restart when the system accumulatively operates for **12 hours**, which can maximize the service life of the system.

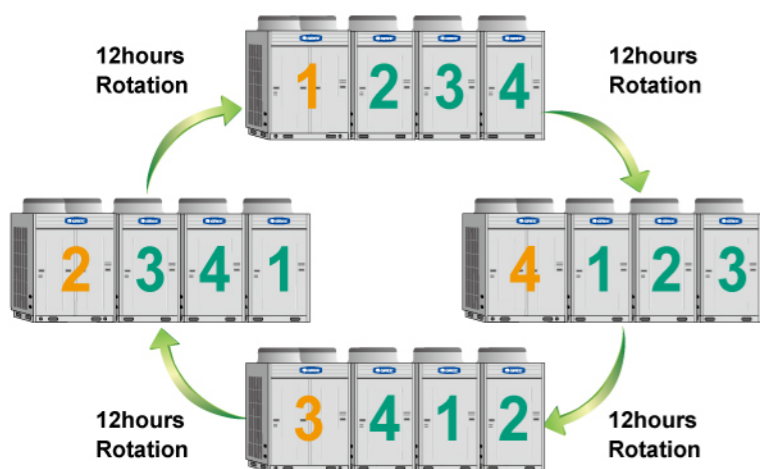

## Emergency operation

Each module is an independent sub-system, and the whole system won't fail down even if partial malfunction. Upon malfunction of any one of the modules, emergency operation can be performed after simply manual set up on the outdoor PCB switches.



## Continuous operation of indoor unit

Each indoor unit is controlled individually on the system network. This allows all indoor units will continue to work even if an error might occur at any indoor unit's on the VRF system.

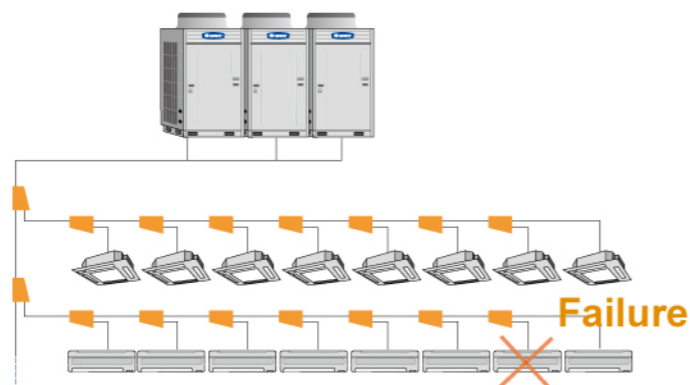

## Wide voltage range operation

The unit can safely operate within **342V~456V**.

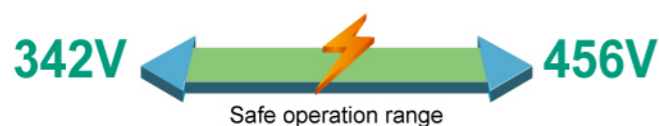

## Power supply security

With power supply security, the outdoor unit will start auto-protection if the power voltage or the current is out of the normal range. Protection will be relieved automatically if the power condition resumes normal.

## PCB protection design

With unique high efficiency radiating air-duct design, the outdoor electric box is designed as water-proof, dust-proof, damp-proof and well-ventilated, which can ensure the required condition for the electric elements even in tropical conditions, highly improves the system reliability and service life.

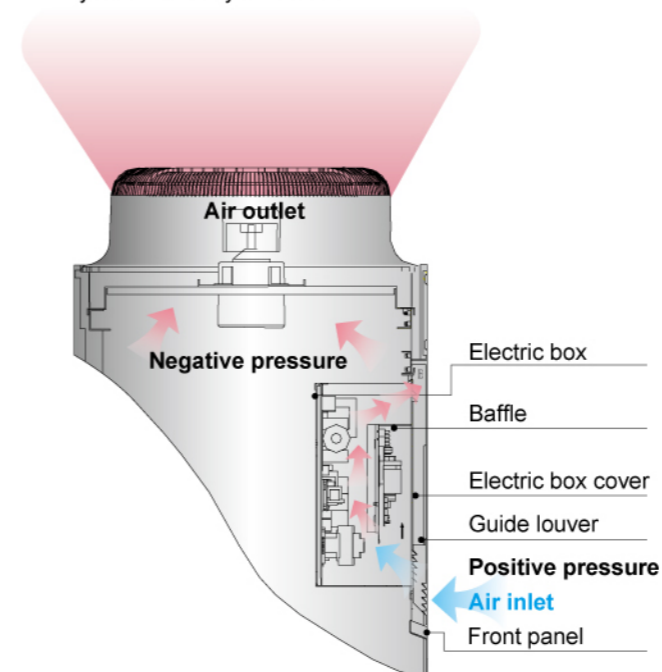

## Anti-corrosion

The primary material of Golden Fin is Al-Mn (Aluminum-Manganese) anti-rust alloy, which is coated with the Golden Protection Layer (Components: Epoxy Resin & Modified Acrylic, Silicon free), the anti-corrosive performance in salt-spray testing is **200%~300%** higher than normal Blue Fin\*.

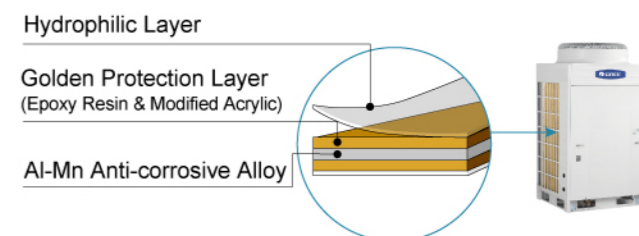

\* Salt-spray testing result is from GREE materials chemistry testing laboratory.

## New generation of oil return control

Through pressure control, the oil return of the system is efficiently optimized, thus greatly improving operation life of the compressor.

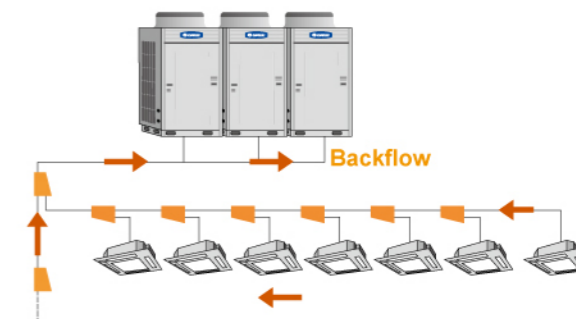

## High efficiency oil-balanced technology

► High pressure chamber compressor with oil-balanced pipe can automatically drain out the excess oil which can prevent oil-unbalance between the compressors.

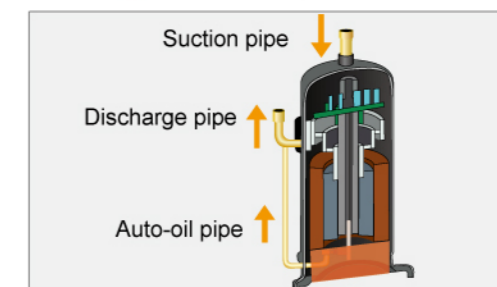

- New patented oil separator allows the oil separating efficiency up to **99%**.
- Oil equalizing pipe connection design at the outside of the modules allows high reliability.

Before Oil Balanced

After Oil Balanced

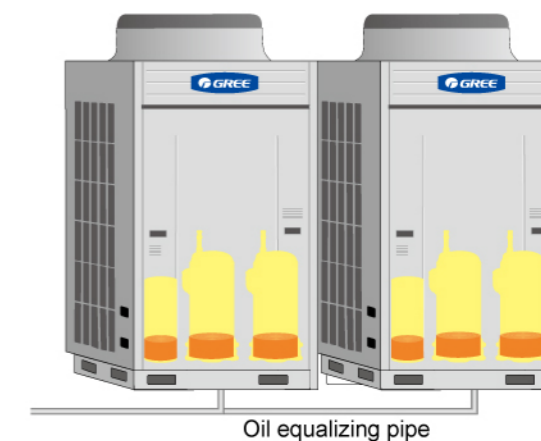
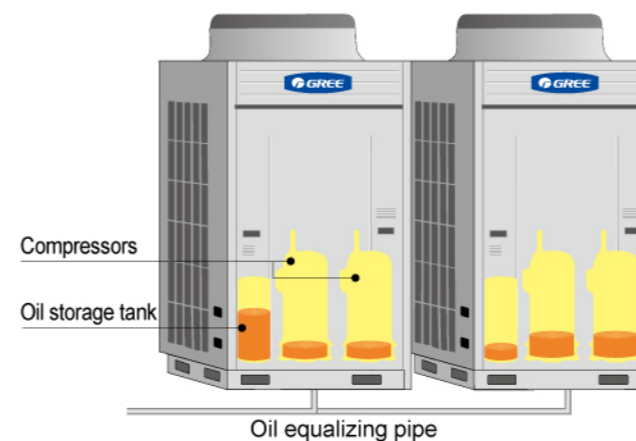

# BETTER VERSATILITY



## Long piping design

- ▶ Maximum total piping length — **500m**
- ▶ Maximum actual piping length — **150m**  
Maximum equivalent piping length — **175m**
- ▶ Maximum height difference between indoor units — **15m**
- ▶ Maximum height difference between outdoor and indoor units — **50m\***
- ▶ Maximum piping length from first indoor branch to the farthest indoor unit — **40m**

\*This value is based on the outdoor unit is located above the indoor unit. If the outdoor unit is located underneath the indoor unit, the value is 40m.

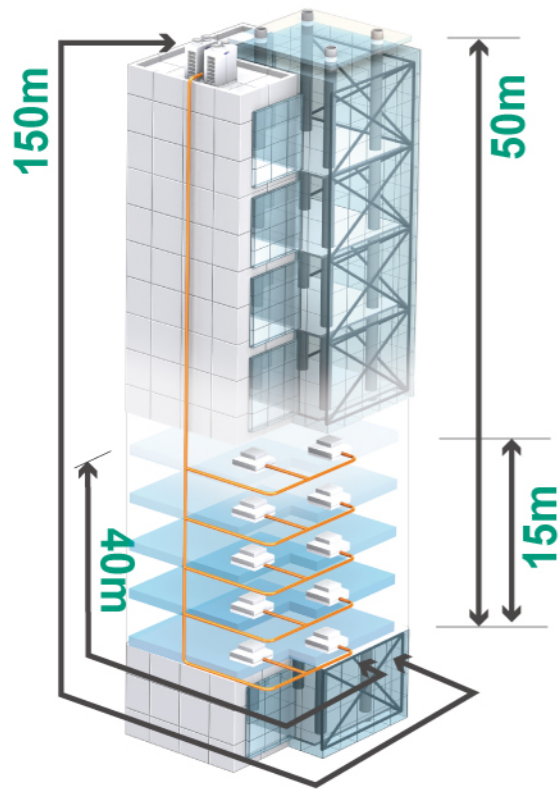

## Higher static pressure of outdoor unit

The maximum external static pressure (ESP) of the outdoor fan can reach up to 75Pa.

The outdoor unit can be installed in the equipments room of high buildings.

\* Default ESP of the product is 40Pa. If higher ESP is required, please contact us.

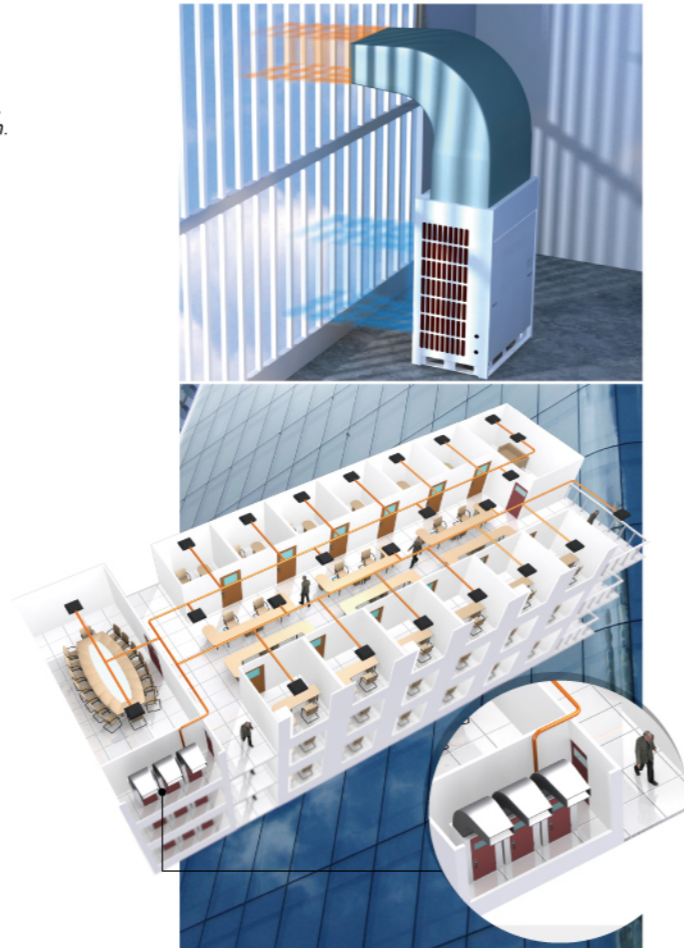

## Wide operation range

The unit can operate in wide range, greatly reducing the ambient temperature limitation.

Note:

- If the required capacity of indoor units is 50% higher than outdoor unit, cooling range may be lower to -15°C.
- If the required capacity of indoor units is 50% lower than outdoor unit, cooling range may be up to -5°C.

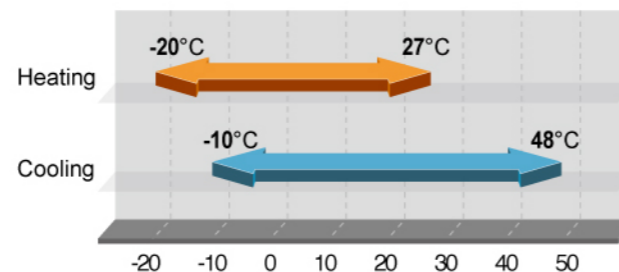

## Compact design

Compact size has been achieved by significantly reducing the width of the outdoor units compared to previous models.

Former model (8HP)



Floor area: **0.87m<sup>2</sup>**

GMV IV (8HP)



Floor area: **0.72m<sup>2</sup>**

**17%**  
reduction



Former model (8HP + 8HP)



Floor area: **1.74m<sup>2</sup>**

GMV IV (16HP)



Floor area: **1.03m<sup>2</sup>**

**41%**  
reduction



## Modular outdoor unit design

- ▶ Various combination from **8HP** to **64HP** with **2HP** increments.
- ▶ Max capacity of outdoor unit is **180kW** (4 x modules)



## Various combinations

- ▶ Up to **110** sets of indoor units can be connected\*.  
\* For the standard model that 4 modules connect in parallel, up to 64 indoor units can be connected. If more indoor units are required to be connected, please contact us.
- ▶ **12** types and **69** models.
- ▶ Maximum diversity is **135%**.

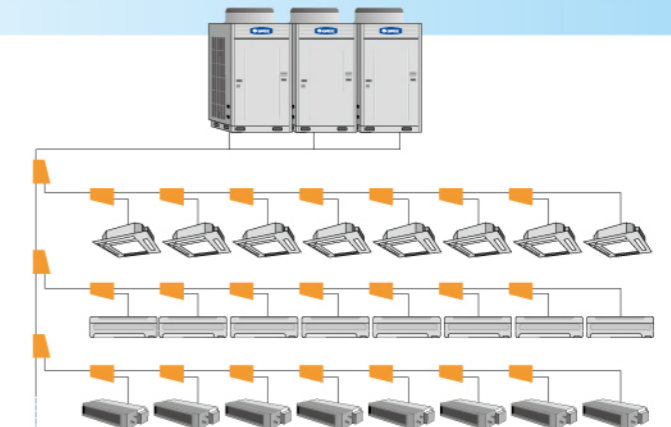

# EASY INSTALLATION & MAINTENANCE



## Easier maintainability

### ► Special-designed electric box

The electric box can be opened by inverting downwards for easy maintenance.

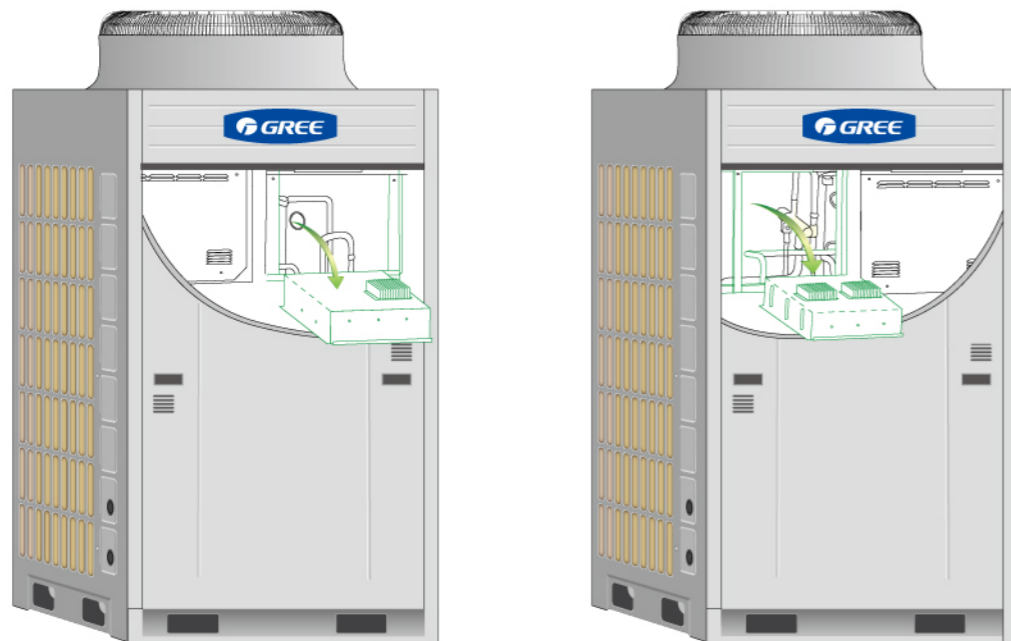

### ► Error display & Self diagnostics system

Through LED display (different combinations of ON, OFF or BLINK) on the main board, the malfunction can be judged.

- Self diagnostics system display



- LED display on the connection board



- LED display on the connection board

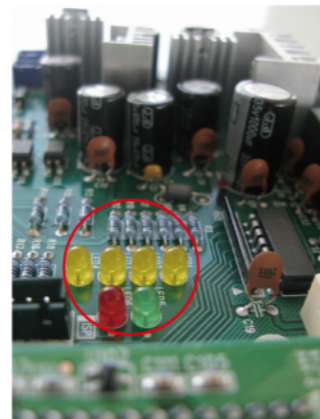

## Easier transportation & installations

### ► Light weight

Former model (8HP+8HP):  
240x2=480kg

GMV IV (16HP):  
370kg



### ► Optimized base frame

Optimized base frame, the locating and fixing of the outdoor unit during installation is more convenient and reliable.

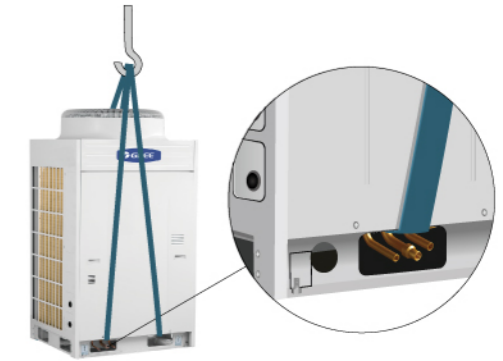

### ► Transportable by forklift



### ► Five-way piping connection

- Piping and wiring are available to the front and back, left and right, and bottom.
- The five-way piping connection reduces installation difficulty and cost, improves the installation efficiency.



### ► Compact design

With compact design, the outdoor unit can be carried to the roof of building through elevator, no crane is needed.

#### Traditional Central Air Conditioner

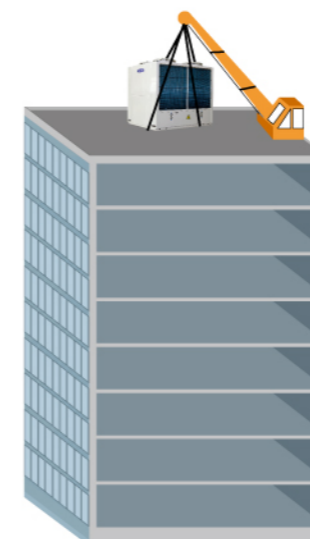



# GMV MINI



## Flexible design

### ▶ Long piping design

- Maximum total piping length — **150m**
- Maximum actual piping length — **70m**  
Maximum equivalent piping length — **80m**
- Maximum height difference between outdoor and indoor units — **10m**
- Maximum height difference between outdoor and indoor units — **30m\***
- Maximum piping length from first indoor branch and the farthest indoor unit — **25m**

\* This value is based on the outdoor unit is located above the indoor unit. If the outdoor unit is located underneath the indoor unit, the value is 25m.

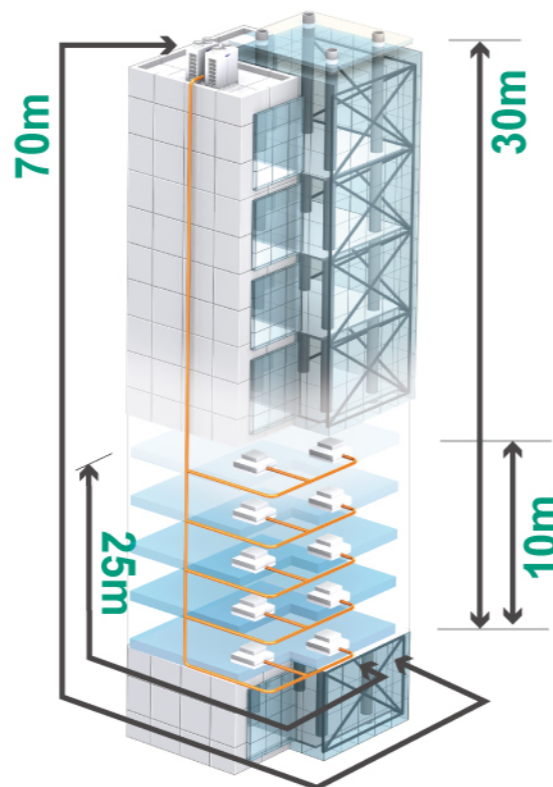

### ▶ Compact design

Compact size has been achieved by significantly reducing the width of the outdoor units compared to previous models.

#### Former model



Floor area: 0.374m<sup>2</sup>

**14% reduction**



#### GMV IV



Floor area: 0.323m<sup>2</sup>

## Wide voltage range operation

The unit can safely operate within the power supply voltage from **185V** to **264V**.



## High efficiency

### DC inverter rotary compressor

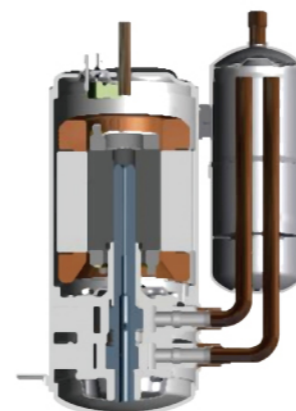

## Comfort

### Auto quiet operation

The unit is ensured to operate with lowest noise by ultra-low fan speed and auto adjustment according to system parameters, reducing the operation noise value of the unit by **3dB(A)** at lower loading.

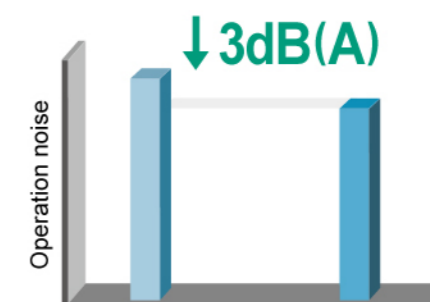

## Easy installation

When total piping length (A+B+C+D+a+b+c+d) ≤ **50m**, no additional refrigerant is required.

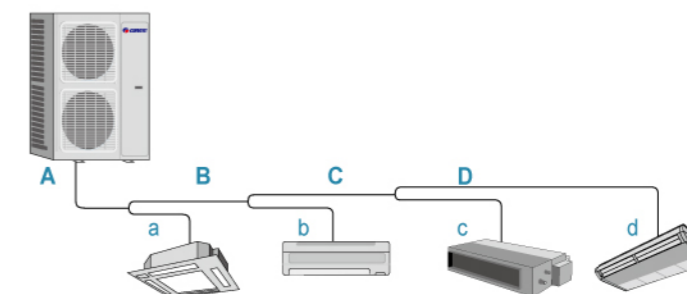

## Powerful heating in low temperature





When outdoor ambient temperature is low, system can automatically increase the heating effect according to its judgment on parameters. Heating performance is improved by **15%**, which brings great comfort.







## Capacity

MODEL		GMV-Pd100W/NaB-K	GMV-Pd120W/NaB-K	GMV-Pd140W/NaB-K	GMV-Pd16W/NaB-K
CAPACITY	HP	3.5	4.0	5.0	6.0
	kW	10	12	14	16
Power supply		1Phase, 220-240V, 50Hz			

# OUTDOOR UNITS LINEUP



MODEL		GMV-Pdm224W/NaB-M (8HP)	GMV-Pdm280W/NaB-M (10HP)	GMV-Pdm335W/NaB-M (12HP)	GMV-Pdm400W/NaB-M (14HP)	GMV-Pdm450W/NaB-M (16HP)
	GMV-Pdm224W/NaB-M (8HP)	●				
	GMV-Pdm228W/NaB-M (10HP)		●			
	GMV-Pdm335W/NaB-M (12HP)			●		
	GMV-Pdm400W/NaB-M (14HP)				●	
	GMV-Pdm450W/NaB-M (16HP)					●
	GMV-Pdm504W/NaB-M (18HP)	●	●			
	GMV-Pdm560W/NaB-M (20HP)		●●			
	GMV-Pdm615W/NaB-M (22HP)		●	●		
	GMV-Pdm670W/NaB-M (24HP)		●		●	
	GMV-Pdm730W/NaB-M (26HP)		●			●
	GMV-Pdm785W/NaB-M (28HP)			●		●
	GMV-Pdm850W/NaB-M (30HP)				●	●
	GMV-Pdm900W/NaB-M (32HP)					●●

MODEL		GMV-Pdm224W/NaB-M (8HP)	GMV-Pdm280W/NaB-M (10HP)	GMV-Pdm335W/NaB-M (12HP)	GMV-Pdm400W/NaB-M (14HP)	GMV-Pdm450W/NaB-M (16HP)
	GMV-Pdm950W/NaB-M (34HP)		●●		●	
	GMV-Pdm1008W/NaB-M (36HP)		●●			●
	GMV-Pdm1605W/NaB-M (38HP)		●	●		●
	GMV-Pdm1130W/NaB-M (40HP)		●		●	●
	GMV-Pdm1180W/NaB-M (42HP)		●			●●
	GMV-Pdm1253W/NaB-M (44HP)			●		●●
	GMV-Pdm1300W/NaB-M (46HP)				●	●●
	GMV-Pdm1350W/NaB-M (48HP)					●●●
	GMV-Pdm1405W/NaB-M (50HP)		●●		●	●
	GMV-Pdm1456W/NaB-M (52HP)		●●			●●
	GMV-Pdm1512W/NaB-M (54HP)		●	●		●●
	GMV-Pdm1570W/NaB-M (56HP)		●		●	●●
	GMV-Pdm1650W/NaB-M (58HP)		●			●●●
	GMV-Pdm1700W/NaB-M (60HP)			●		●●●
	GMV-Pdm1750W/NaB-M (62HP)				●	●●●
	GMV-Pdm1800W/NaB-M (64HP)					●●●●

# SPECIFICATIONS

## GMV Mini

RATING CAPACITY		HP	3.5	4	5	6
Model			GMV-Pd 100W/NaB-K	GMV-Pd 120W/NaB-K	GMV-Pd 140W/NaB-K	GMV-Pd 160W/NaB-K
Combination units			—	—	—	—
Connectable indoor unit	Maximum		6	7	8	9
	Cooling capacity	kW	5.0-13.5	6.0-16.2	7.0-18.9	8.0-21.6
Power supply			1-Phase, 220-240V, 50Hz			
Capacity	Cooling	kW	10.0	12.0	14.0	16.0
	Heating	kW	11.0	14.0	15.4	17.6
Power consumption	Cooling	kW	2.86	3.50	4.36	4.98
	Heating	kW	2.60	3.40	4.05	4.85
Compressor		Type	DC inverter dual-rotor type compressor×1			
Airflow rate		m³/h	6200	6200	6000	6400
		CFm	3642	3642	3525	3759
Sound pressure level		dB(A)	58	58	58	58
Dimensions	W×D×H	mm	950×340×1250	950×340×1250	950×340×1250	950×340×1250
Net weight		kg	135	135	135	135
Refrigerant charge		kg	7.5	7.5	7.5	7.5
Operation range		°C	Cooling:10 to 48, Heating:-15 to 27			
		°F	Cooling:18 to 118.4, Heating:-4 to 81			
Connection pipe diameter	Gas	inch	5/8	5/8	5/8	3/4
	Liquid	inch	3/8	3/8	3/8	3/8

## Basic Module

RATING CAPACITY		HP	8	10	12	14	16
Model			GMV-Pdm224W/NaB-M	GMV-Pdm280W/NaB-M	GMV-Pdm335W/NaB-M	GMV-Pdm400W/NaB-M	GMV-Pdm450W/NaB-M
Combination units			—				
Connectable indoor unit	Maximum		14	16	16	16	16
	Cooling capacity	kW	11.2-30.2	14.0-37.8	16.8-45.2	20.0-54.0	22.5-60.8
Power supply			3-Phase, 380-415V, 50Hz				
Capacity	Cooling	kW	22.4	28.0	33.5	40.0	45.0
	Heating	kW	25.0	31.5	37.5	45.0	50.0
Power consumption	Cooling	kW	5.52	7.52	9.23	12.45	14.32
	Heating	kW	5.82	7.70	9.38	11.20	13.90
Compressor		Configuration *	DC×1+C×1		DC×1+C×2		
Airflow rate		m³/h	10000	10000	13000	13000	13000
		CFm	5874	5874	7636	7636	7636
Sound pressure level		dB(A)	58	58	60	61	61
Dimensions	W×D×H	mm	930×770×1670		1340×770×1670		
Net weight		kg	255	256	350	350	370
Operating weight		kg	275	275	380	380	400
Refrigerant charge		kg	12	13	15	16	17
Operation range		°C	Cooling:-5 to 48, Heating:-20 to 27				
		°F	Cooling:23 to 118.4, Heating:-4 to 81				
Connection pipe diameter	Gas	inch	7/8	7/8	9/8	9/8	9/8
	Liquid	inch	3/8	3/8	1/2	1/2	1/2

\* DC: DC inverter scroll compressor

C: Constant speed scroll compressor

## Combination Modules

RATING CAPACITY		HP	18	20	22	24	26
Model			GMV-Pdm504W2/NaB-M	GMV-Pdm560W2/NaB-M	GMV-Pdm615W2/NaB-M	GMV-Pdm670W2/NaB-M	GMV-Pdm730W2/NaB-M
Combination units			GMV-Pdm224W/NaB-M GMV-Pdm280W/NaB-M	GMV-Pdm280W/NaB-M GMV-Pdm280W/NaB-M	GMV-Pdm280W/NaB-M GMV-Pdm335W/NaB-M	GMV-Pdm280W/NaB-M GMV-Pdm400W/NaB-M	GMV-Pdm280W/NaB-M GMV-Pdm280W/NaB-M
Connectable indoor unit	Maximum		30	32	32	32	32
	Cooling capacity	kW	25.2-68	28.0-75.6	30.8-83.0	33.5-90.5	36.5-98.6
Power supply			3-Phase, 380-415V, 50Hz				
Capacity	Cooling	kW	50.4	56.0	61.5	68.0	73.0
	Heating	kW	56.5	63.0	69.0	76.5	81.5
Power consumption	Cooling	kW	13.04	15.04	16.75	19.97	21.84
	Heating	kW	13.52	15.40	17.08	18.90	21.60
Compressor		Configuration *	(DC×1+C×1)×2		(DC×1+C×1)+(DC×1+C×2)		
Airflow rate		m³/h	10000×2	10000×2	10000+13000	10000+13000	10000+13000
		CFm	5874×2	5874×2	5874+7636	5874+7636	5874+7636
Sound pressure level		dB(A)	62	62	62	62	63
Dimensions	W×D×H	mm	(930×770×1670)+(930×770×1670)		(930×770×1670)+(1340×770×1670)		
Net weight		kg	255+255	255+255	255+350	255+350	255+370
Refrigerant charge		kg	13+13	13+15	13+15	13+16	13+17
Operation range		°C	Cooling:-5 to 48, Heating:-20 to 27				
		°F	Cooling:23 to 118.4, Heating:-4 to 81				
Connection pipe diameter	Gas	inch	9/8	9/8	9/8	9/8	11/8
	Liquid	inch	5/8	5/8	5/8	3/4	3/4

RATING CAPACITY		HP	28	30	32	34	36
Model			GMV-Pdm785W2/NaB-M	GMV-Pdm850W2/NaB-M	GMV-Pdm900W2/NaB-M	GMV-Pdm950W2/NaB-M	GMV-Pdm730W2/NaB-M
Combination units			GMV-Pdm335W/NaB-M GMV-Pdm450W/NaB-M	GMV-Pdm400W/NaB-M GMV-Pdm450W/NaB-M	GMV-Pdm450W/NaB-M GMV-Pdm450W/NaB-M	GMV-Pdm280W/NaB-M GMV-Pdm280W/NaB-M GMV-Pdm400W/NaB-M	GMV-Pdm280W/NaB-M GMV-Pdm280W/NaB-M GMV-Pdm450W/NaB-M
Connectable indoor unit	Maximum		32	32	32	48	48
	Cooling capacity	kW	39.3-106.0	42.5-114.8	45.0-121.5	47.5-128.3	50.4-136.1
Power supply			3-Phase, 380-415V, 50Hz				
Capacity	Cooling	kW	78.5	85.0	90.0	96.0	101.0
	Heating	kW	87.5	95.0	100.0	108.0	113.0
Power consumption	Cooling	kW	23.55	26.77	28.64	27.49	29.36
	Heating	kW	23.28	25.10	27.80	26.60	29.30
Compressor		Configuration *	(DC×1+C×2)×2		((DC×1+C×1)×2)+(DC×1+C×2)		
Airflow rate		m³/h	13000×2	13000×2	13000×2	10000×2+13000	
		CFm	7636×2	7636×2	7636×2	5874×2+7636	
Sound pressure level		dB(A)	63	63	63	64	64
Dimensions	W×D×H	mm	(1340×770×1670)+(1340×770×1670)		(930×770×1670)+(930×770×1670)+(1340×770×1670)		
Net weight		kg	350+370	350+370	370+370	255+255+350	255+255+370
Refrigerant charge		kg	15+16	18+17	17+17	13+13+16	13+13+17
Operation range		°C	Cooling:-5 to 48, Heating:-20 to 27				
		°F	Cooling:23 to 118.4, Heating:-4 to 81				
Connection pipe diameter	Gas	inch	11/8	11/8	11/8	11/8	11/8
	Liquid	inch	3/4	3/4	3/4	3/4	3/4

\* DC: DC inverter scroll compressor

C: Constant speed scroll compressor

## Combination Modules

RATING CAPACITY		HP	38	40	42	44	46	48
Model			GMV-Pdm 1065W3/NaB-M	GMV-Pdm 1130W3/NaB-M	GMV-Pdm 1180W3/NaB-M	GMV-Pdm 1235W3/NaB-M	GMV-Pdm 1300W3/NaB-M	GMV-Pdm 1350W3/NaB-M
Combination units			GMV-Pdm 280W/NaB-M GMV-Pdm 335W/NaB-M GMV-Pdm 450W/NaB-M	GMV-Pdm 280W/NaB-M GMV-Pdm 400W/NaB-M GMV-Pdm 450W/NaB-M	GMV-Pdm 280W/NaB-M GMV-Pdm 450W/NaB-M GMV-Pdm 450W/NaB-M	GMV-Pdm 335W/NaB-M GMV-Pdm 450W/NaB-M GMV-Pdm 450W/NaB-M	GMV-Pdm 400W/NaB-M GMV-Pdm 450W/NaB-M GMV-Pdm 450W/NaB-M	GMV-Pdm 450W/NaB-M GMV-Pdm 455W/NaB-M GMV-Pdm 450W/NaB-M
Connectable indoor unit	Maximum		48	48	48	48	48	48
	Cooling capacity	kW	53.3-143.8	56.5-152.6	59.0-159.3	61.81-66.7	65.0-175.5	67.5-182.3
Power supply			3-Phase, 380-415V, 50Hz					
Capacity	Cooling	kW	106.5	113.0	118.0	123.5	130.0	135.0
	Heating	kW	119.0	126.5	131.5	137.5	145.0	150.0
power consumption	Cooling	kW	31.07	34.29	36.16	37.87	41.09	42.96
	Heating	kW	30.98	32.80	35.50	37.18	39.00	41.70
Compressor	Configuration*		(DC×1+C×1)+(DC×1+C×2)×2			(DC×1+C×2)×3		
Airflow rate	m³/h		10000+13000×2			13000×3	13000×3	13000×3
	CFm		5874+7636×2			7636×3	7636×3	7636×3
Sound pressure level	dB(A)		64	64	64	65	65	65
Dimensions	W×D×H	mm	(930×770×1670)+(1340×770×1670)+(1340×770×1670)			(1340×770×1670)+(1340×770×1670)+(1340×770×1670)		
Net weight		kg	255+350+370			350+370+370	350+370+370	370+370+370
Refrigerant charge		kg	13+15+17	13+16+17	13+17+17	15+17+17	16+17+17	17+17+17
Operation range	°C		Cooling:-5 to 48, Heating:-20 to 27					
	°F		Cooling:23 to 118.4, Heating:-4 to 81					
Connection pipe diameter	Gas	inch	13/8	13/8	13/8	13/8	13/8	13/8
	Liquid	inch	3/4	3/4	3/4	3/4	3/4	3/4

RATING CAPACITY		HP	50	52	54	56	58	
Model			GMV-Pdm 1405W4/NaB-M	GMV-Pdm 1456W4/NaB-M	GMV-Pdm 1512W4/NaB-M	GMV-Pdm 1570W4/NaB-M	GMV-Pdm 1650W5/NaB-M	
Combination units			GMV-Pdm 280W/NaB-M GMV-Pdm 280W/NaB-M GMV-Pdm 440W/NaB-M GMV-Pdm 450W/NaB-M	GMV-Pdm 280W/NaB-M GMV-Pdm 280W/NaB-M GMV-Pdm 450W/NaB-M GMV-Pdm 450W/NaB-M	GMV-Pdm 280W/NaB-M GMV-Pdm 335W/NaB-M GMV-Pdm 450W/NaB-M GMV-Pdm 450W/NaB-M	GMV-Pdm 280W/NaB-M GMV-Pdm 400W/NaB-M GMV-Pdm 450W/NaB-M GMV-Pdm 450W/NaB-M	GMV-Pdm 280W/NaB-M GMV-Pdm 450W/NaB-M GMV-Pdm 450W/NaB-M GMV-Pdm 450W/NaB-M	
Connectable indoor unit	Maximum		64	64	64	64	64	
	Cooling	kW	70.3-189.7	72.8-196.6	75.6-204.1	78.5-212.0	82.5-222.8	
Power supply			3-Phase, 380-415V, 50Hz					
Capacity	Cooling	kW	141.0	146.0	151.5	155.0	163.0	
	Heating	kW	158.0	163.0	169.0	176.5	181.5	
power consumption	Cooling	kW	41.84	43.68	45.39	48.61	50.48	
	Heating	kW	40.05	43.20	44.88	46.70	49.90	
Compressor	Configuration*		((DC×1+C×1)×2)+((DC×1+C×2)×2)		(DC×1+C×1)+(DC×1+C×2)×3			
Airflow rate	m³/h		10000×2+13000×2		10000+13000×3			
	CFm		5874×2+7636×2		5874+7636×3			
Sound pressure level	dB(A)		65	65	65	65	65	
Dimensions	W×D×H	mm	(930×770×1670)+(930×770×1670) +(1340×770×1670)+(1340×770×1670)		(930×770×1670)+(1340×770×1670) +(1340×770×1670)+(1340×770×1670)			
Net weight		kg	255+255+350+370		255+350+370+370	255+350+370+370	255+370+370+370	
Refrigerant charge		kg	13+13+16+17	13+13+17+17	13+15+17+17	13+16+17+17	13+17+17+17	
Operation range	°C		Cooling:-5 to 48, Heating:-20 to 27					
	°F		Cooling:23 to 118.4, Heating:-4 to 81					
Connection pipe diameter	Gas	inch	7/4	7/4	7/4	17/8	17/8	
	Liquid	inch	7/8	7/8	7/8	1	1	

\* DC: DC inverter scroll compressor

C: Constant speed scroll compressor

## Combination Modules

RATING CAPACITY		HP	60	62	64
Model			GMV-Pdm 1700W4/NaB-M	GMV-Pdm 1750W4/NaB-M	GMV-Pdm 1800W4/NaB-M
Combination units			GMV-Pdm 335W/NaB-M GMV-Pdm 450W/NaB-M GMV-Pdm 450W/NaB-M GMV-Pdm 450W/NaB-M	GMV-Pdm 400W/NaB-M GMV-Pdm 450W/NaB-M GMV-Pdm 450W/NaB-M GMV-Pdm 450W/NaB-M	GMV-Pdm 450W/NaB-M GMV-Pdm 450W/NaB-M GMV-Pdm 450W/NaB-M GMV-Pdm 450W/NaB-M
Connectable indoor unit	Maximum		64	64	64
	Cooling	kW	85.0-230.0	87.5-236.3	80.0-243.0
Power supply			3-Phase, 380-415V, 50Hz		
Capacity	Cooling	kW	168.0	175.0	180.0
	Heating	kW	187.5	195.0	200.0
power consumption	Cooling	kW	52.19	55.41	57.21
	Heating	kW	51.80	52.90	55.60
Compressor	Configuration*		(DC×1+C×2)×4	(DC×1+C×2)×4	(DC×1+C×2)×4
Airflow rate	m³/h		13000×4	13000×4	13000×4
	CFm		7636×4	7636×4	7636×4
Sound pressure level	dB(A)		66	66	66
Dimensions	W×D×H	mm	(1340×770×1670)+(1340×770×1670)+(1340×770×1670)+(1340×770×1670)		
Net weight		kg	350+370+370+370		
Refrigerant charge		kg	15+17+17+17	16+17+17+17	17+17+17+17
Operation range	°C		Cooling:-5 to 48, Heating:-20 to 27		
	°F		Cooling:23 to 118.4, Heating:-4 to 81		
Connection pipe diameter	Gas	inch	17/8	17/8	17/8
	Liquid	inch	1	1	1

\* DC: DC inverter scroll compressor

C: Constant speed scroll compressor



# INDOOR UNITS LINEUP



Various designs indoor units suit perfectly for different installation requirement.

CAPACITY INDEX(kW)	2.2	2.8	3.6	4.5	5.0	5.6	6.3	7.1	8.0	9.0	10.0	11.2	12.5	14.0	22.4	28.0
Duct Type (EXV Integrate)																
Slim Duct Type (EXV Integrate) <b>NEW</b>																
Four-way Cassette Type (EXV Integrate)																
Compact Four-way Cassette Type (EXV Separated) <b>NEW</b>																
One-way Cassette Type (EXV Separated)																
Floor Ceiling Type (EXV Separated)																
Floor Ceiling Type (EXV Integrate) <b>NEW</b>																
Wall Mounted Type (EXV Separated)																
Wall Mounted Type (EXV Integrate) <b>NEW</b>																
Treated Fresh Air Duct Type																

# DUCT TYPE

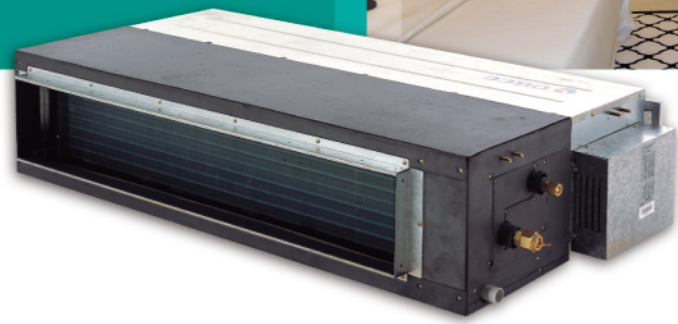

## Highly flexible installation

► Highly flexible installation is possible to satisfy various needs.

### Installation examples

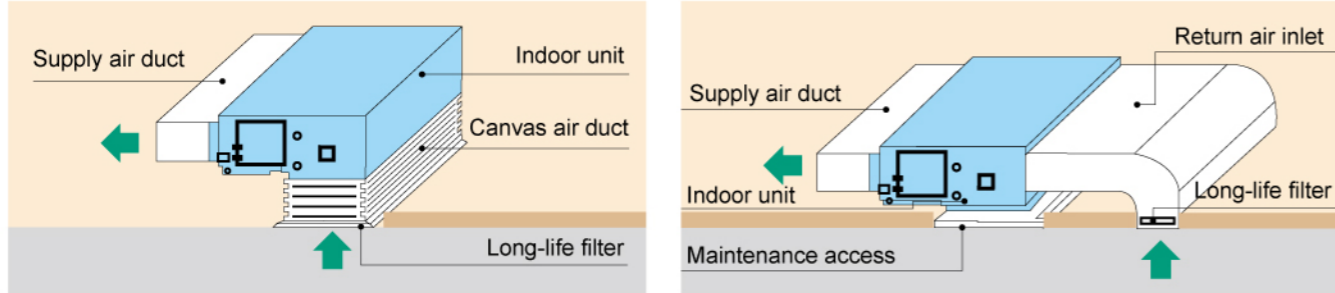

► Flexible and easy to install in type-L, type-U and large rooms.

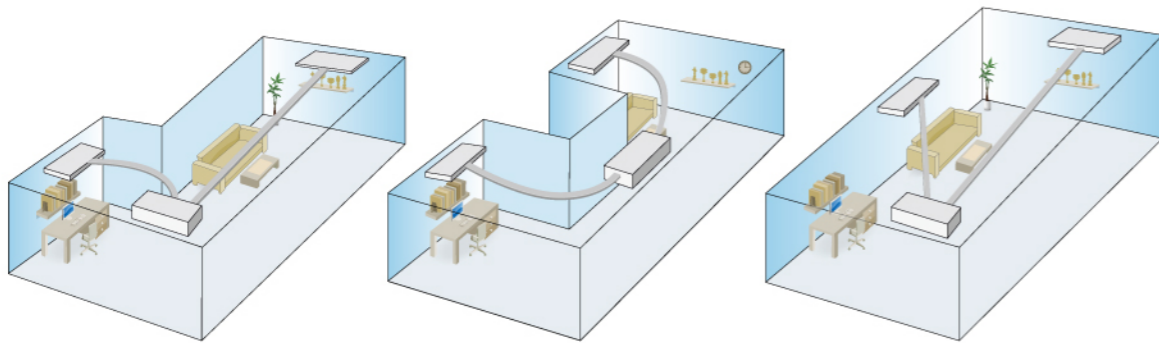

## Fresh air function option for 5.6kW and above units

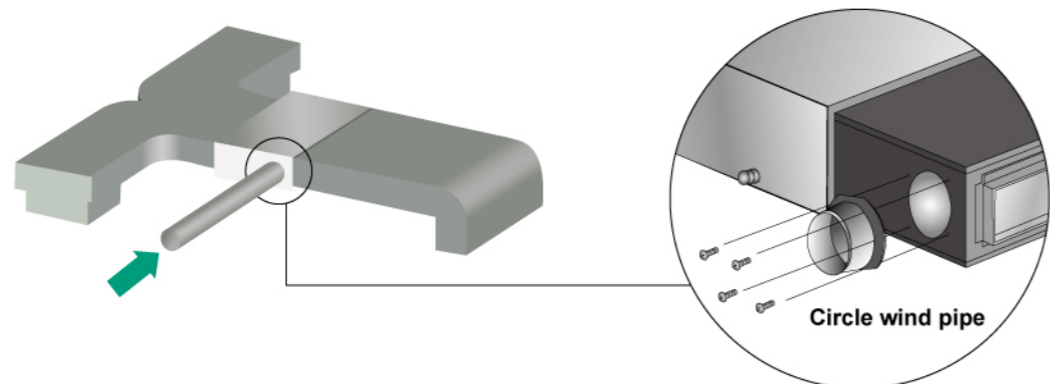

## Drain pump lift reaches 1000mm

Only available for GMV(L)-R\*PS/NaB-K

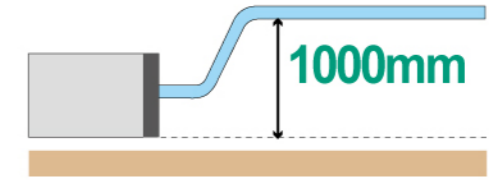

## Easy maintenance

- Long life and washable filter with buckles can be easily disassembled from each direction.
- Compact size has been achieved by significantly reducing the width of the outdoor units compared to previous models.

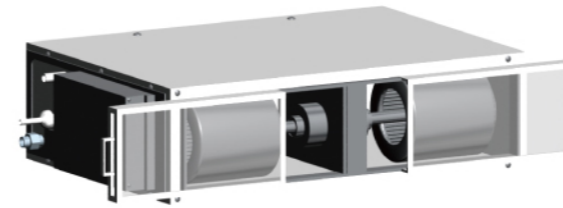

### Former structure: push-pull type

The former structure is not easy to disassembly.

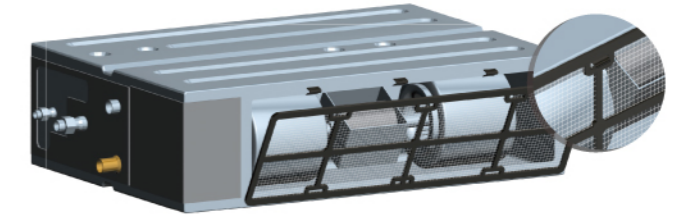

### New structure: with buckles

The new structure makes the disassembly convenient.

## Higher ESP & lower noise

The ESP is obviously upgraded while the noise is almost at the same level as before.

■ Former model    ■ Low ESP of new model  
■ High ESP of new model

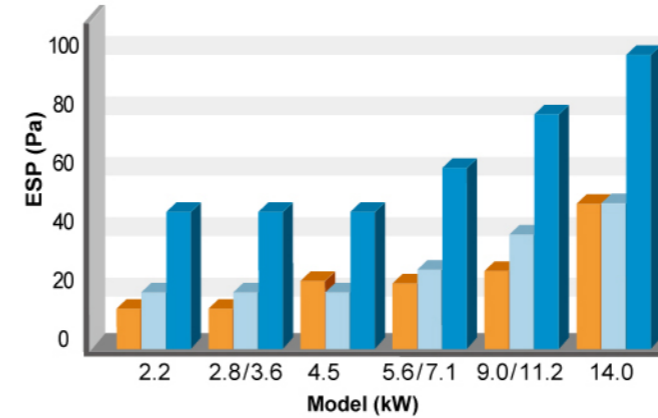

■ Former model    ■ New model (In low ESP)

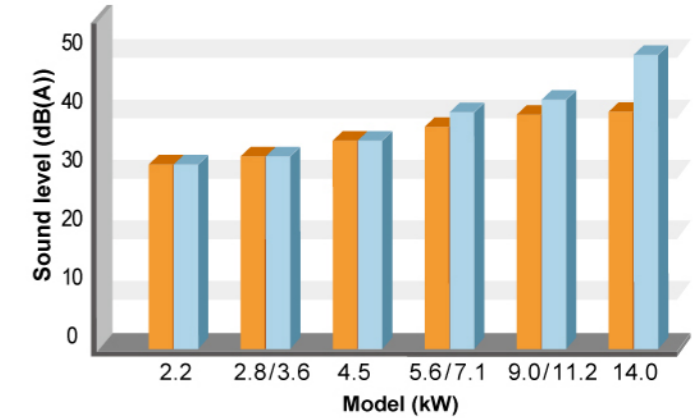

## Key-card control

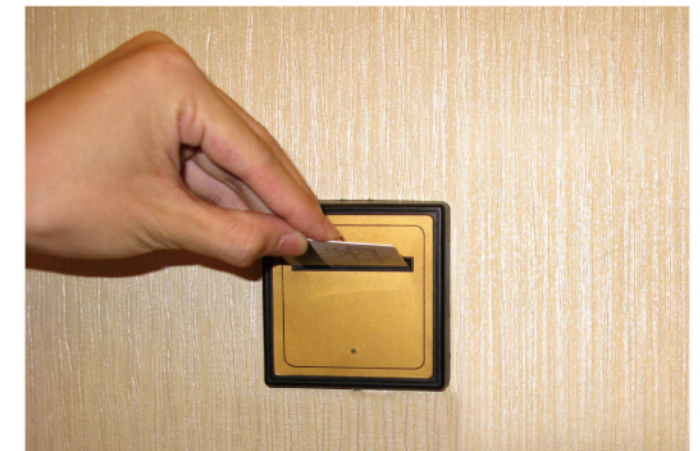

## Duct Type (With Drain Water Pump)

MODEL			GMV(L)-R22PS/NaB-K	GMV(L)-R28PS/NaB-K	GMV(L)-R36PS/NaB-K	GMV(L)-R45PS/NaB-K
Power supply			1-Phase, 220-240V, 50Hz			
Capacity	Cooling	kW	2.2	2.8	3.6	4.5
	Heating		2.5	3.2	4.0	5.0
Power consumption		W	75	80	80	140
Airflow rate	m³/h		450	570	570	700
	CFm		265	335	336	412
Sound pressure level (H/M/L)		dB(A)	37/35/33	39/37/35	39/37/35	40/38/36
Standard Esp (H/L)		Pa	50/20	50/20	50/20	50/20
Dimensions (W×D×H)		mm	800×600×250			980×721×266
Net weight		kg	28.5	30.5	30.5	36
Connection pipe	Gas (Flare)	inch	3/8	3/8	1/2	1/2
		mm	φ9.52	φ9.52	φ12.7	φ12.7
	Liquid (Flare)	inch	1/4	1/4	1/4	1/4
		mm	φ6.35	φ6.35	φ6.35	φ6.35
Drain pipe	External dia.	mm	φ20	φ20	φ20	φ30
	Thickness	mm	1.5	1.5	1.5	1.5

## Duct Type (Without Drain Water Pump)

MODEL			GMV(L)-R22P/NaB-K	GMV(L)-R28P/NaB-K	GMV(L)-R36PS/NaB-K	GMV(L)-R45P/NaB-K	GMV(L)-R56P/NaB-K	GMV(L)-R71P/NaB-K
Power supply			1-Phase, 220-240V, 50Hz					
Capacity	Cooling	kW	2.2	2.8	3.6	4.5	5.6	7.1
	Heating		2.5	3.2	4.0	5.0	6.3	8.0
Power consumption		W	75	80	80	140	240	240
Airflow rate	m³/h		450	570	570	700	1000	1100
	CFm		265	335	336	412	589	647
Sound pressure level (H/M/L)		dB(A)	37/35/33	39/37/35	39/37/35	40/38/36	44/42/40	45/43/41
Standard Esp (H/L)		Pa	50/20	50/20	50/20	50/20	60/30	60/30
Dimensions (W×D×H)		mm	800×655×250			980×721×266	1155×756×300	
Net weight		kg	27	28.5	28.5	34	49	49
Connection pipe	Gas (Flare)	inch	3/8	3/8	1/2	1/2	5/8	5/8
		mm	φ9.52	φ9.52	φ12.7	φ12.7	φ15.9	φ15.9
	Liquid (Flare)	inch	1/4	1/4	1/4	1/4	3/8	3/8
		mm	φ6.35	φ6.35	φ6.35	φ6.35	φ9.52	φ9.52
Drain pipe	External dia.	mm	φ20	φ20	φ20	φ30	φ30	φ30
	Thickness	mm	1.5	1.5	1.5	1.5	1.5	1.5

MODEL			GMV(L)-R56PS/NaB-K	GMV(L)-R71PS/NaB-K	GMV(L)-R90PS/NaB-K	GMV(L)-R112PS/NaB-K	GMV(L)-R140PS/NaB-K
Power supply			1-Phase, 220-240V, 50Hz				
Capacity	Cooling	kW	5.6	7.1	9.0	11.2	14.0
	Heating		6.3	8.0	10.0	12.5	15.0
Power consumption		W	240	240	360	360	500
Airflow rate	m³/h		1000	1100	1700	1700	2000
	CFm		589	647	1001	1177	1177
Sound pressure level (H/M/L)		dB(A)	44/42/40	45/43/41	48/46/44	48/46/44	50/48/46
Standard Esp (H/L)		Pa	60/30	60/30	80/40	80/40	100/50
Dimensions (W×D×H)		mm	1155×756×300		1425×736×300		
Net weight		kg	51	51	64	64	65.5
Connection pipe	Gas (Flare)	inch	5/8	5/8	5/8	5/8	5/8
		mm	φ15.9	φ15.9	φ15.9	φ15.9	φ15.9
	Liquid (Flare)	inch	3/8	3/8	3/8	3/8	3/8
		mm	φ9.52	φ9.52	φ9.52	φ9.52	φ9.52
Drain pipe	External dia.	mm	φ30	φ30	φ30	φ30	φ30
	Thickness	mm	1.5	1.5	1.5	1.5	1.5

MODEL			GMV(L)-R90P/NaB-K	GMV(L)-R112P/NaB-K	GMV(L)-R140P/NaB-K	GMV(L)-R224P/NaB-M	GMV(L)-R280P/NaB-M
Power supply			1-Phase, 220-240V, 50Hz			3-Phase, 380-450V, 50Hz	
Capacity	Cooling	kW	9.0	11.2	14.0	22.4	28.0
	Heating		10.0	12.5	15.0	25.0	31.0
Power consumption		W	360	360	500	1600	1600
Airflow rate	m³/h		1700	1700	2000	4000	4800
	CFm		1001	1177	1177	2354	2825
Sound pressure level (H/M/L)		dB(A)	48/46/44	48/46/44	50/48/46	56(H)	57(H)
Standard Esp		Pa	80/40	80/40	100/50	200	220
Dimensions (W×D×H)		mm	1425×736×300			1463×799×389	1500×920×450
Net weight		kg	62	62	63.5	88	125
Connection pipe	Gas (Flare)	inch	5/8	5/8	5/8	7/8	7/8
		mm	φ15.9	φ15.9	φ15.9	φ22.2	φ22.2
	Liquid (Flare)	inch	3/8	3/8	3/8	3/8	3/8
		mm	φ9.52	φ9.52	φ9.52	φ9.52	φ9.52
Drain pipe	External dia.	mm	φ30	φ30	φ30	φ25.4	φ25.4
	Thickness	mm	1.5	1.5	1.5	1.5	1.5

# SLIM DUCT TYPE



## Compact design

### ► 2.2kW, 2.8kW, 3.6kW

Only **700mm** in width, **200mm** in height and **22kg\*** in weight which is perfect to install in limited spaces like drop-ceiling in hotel.

*Note: the weight is 23kg for the unit of 3.6kW.*

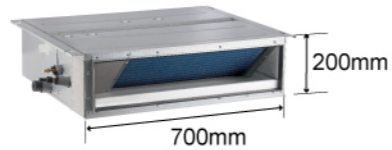

### ► 4.5kW, 5.6kW

Only **200mm** in height which can be installed in rooms with as little as **240mm** depth between the drop-ceiling and ceiling slab.

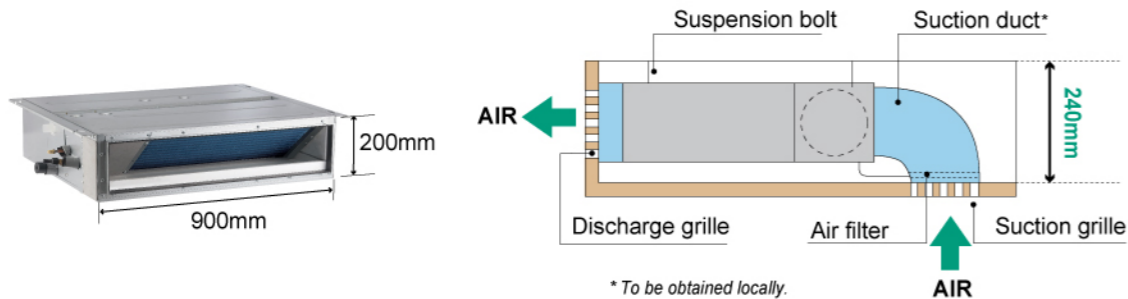

## Highly flexible installation

Highly flexible installation is possible to satisfy various needs.

### Installation examples

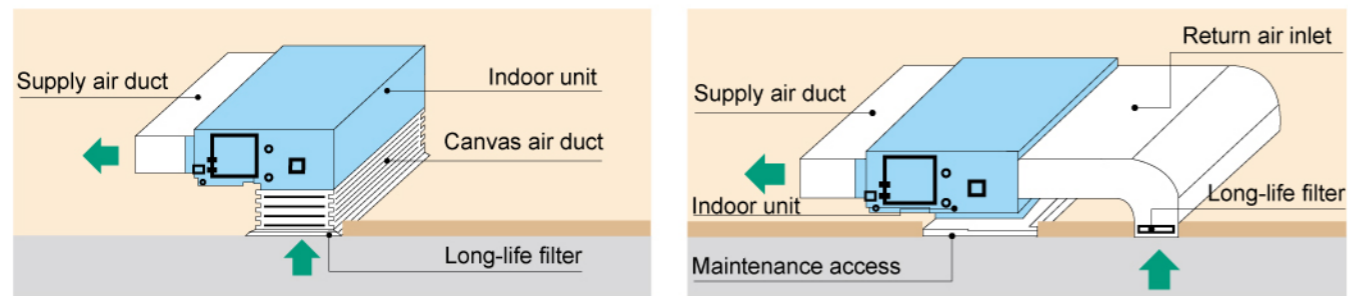

## Lower noise

Plastic propeller housing, fan blade and intelligent-designed air-channel ensure air flow volume with lower operation noise.

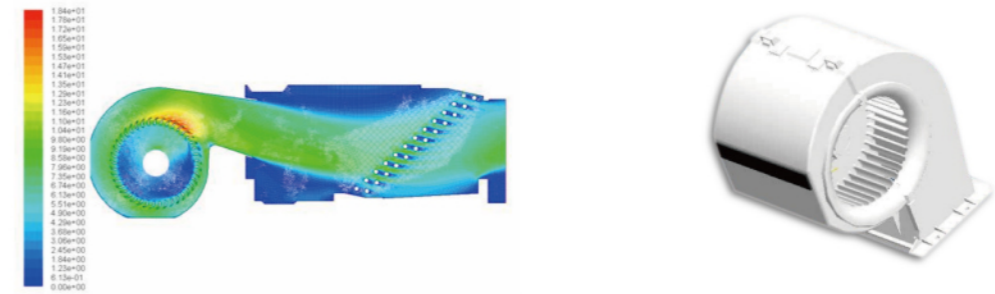

For example, the normal unit of **2.8kW** has the noise level up to **40dB(A)**, but now the new unit of **2.8 kW** reduces the noise to only **37dB(A)**.

## Drain pump lift reaches 1000mm

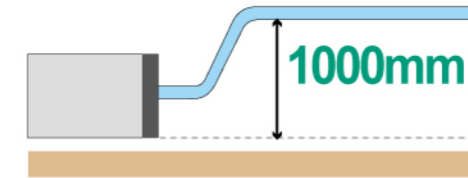

MODEL		GMV(L)-R22P/NaE-K	GMV(L)-R28P/NaE-K	GMV(L)-R36P/NaE-K	GMV(L)-R45P/NaE-K	GMV(L)-R56P/NaE-K	GMV(L)-R71P/NaE-K	
Power supply		1-Phase, 220-240V, 50Hz						
Capacity	Cooling	kW	2.2	2.8	3.6	4.5	5.6	7.1
	Heating	kW	2.5	3.2	4.0	5.0	6.3	8.0
Power consumption	W	64	64	70	91	91	100	
Airflow rate	m³/h	450	450	550	700	700	1000	
	CFm	265	265	324	412	412	589	
Sound pressure level (H/M/L)	dB(A)	37/35/33	37/35/33	39/37/35	40/38/36	41/39/37	42/40/38	
Standard ESP	Pa	20	20	20	20	20	20	
Dimensions (W×D×H)	mm	700×615×200			900×615×200		1100×615×200	
Net weight	kg	21	21	22	26	26	20	
Connection pipe	Gas (Flare)	inch	3/8	3/8	1/2	3/8	3/8	3/8
		mm	φ9.52	φ9.52	φ12.7	φ9.52	φ9.52	φ9.52
	Liquid (Flare)	inch	1/4	1/4	1/4	5/8	5/8	5/8
		mm	φ6.35	φ6.35	φ6.35	φ15.9	φ15.9	φ15.9
Drain pipe	External dia.	mm	φ20	φ20	φ20	φ30	φ30	φ30
	Thickness	mm	1.5	1.5	1.5	1.5	1.5	1.5



# FOUR-WAY CASSETTE TYPE



## Four - way Cassette Type

- ▶ Compact, light weight and square panel in the same size for easy installation

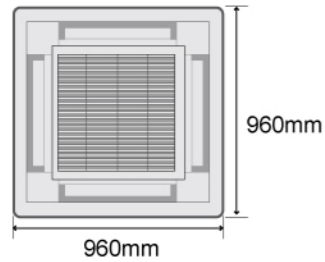

- ▶ Slim unit below 5.0kW is only 190mm in thickness, which can be installed in narrow ceiling space of at least 210mm.

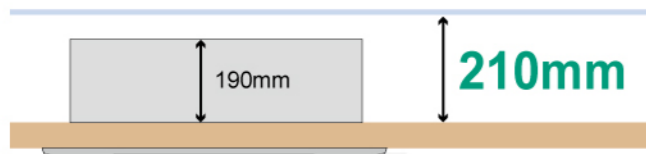

- ▶ Drain pump fitted as standard with increased lift of 1100mm.

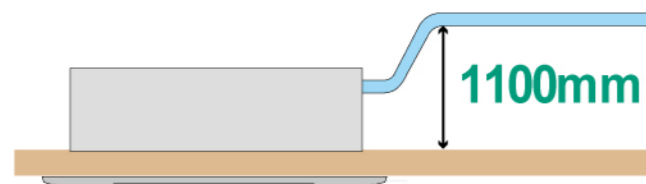

## Compact Four - way Cassette Type

- ▶ Compact size of 650mm x 650mm for 2.8kW-5.6kW

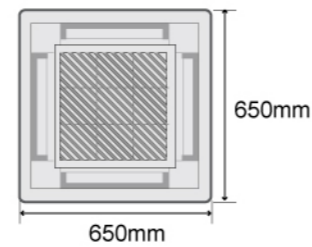

- ▶ Only 230mm in thickness which can be installed in ceiling space of at least 250mm.



- ▶ Drain pump fitted as standard with increased lift of 500mm.

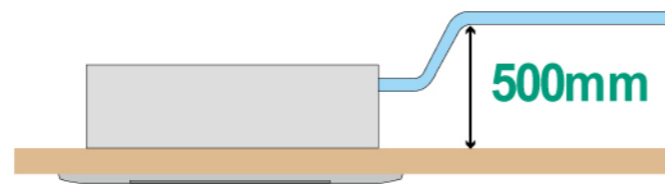

## Common characteristics

- ▶ Low noise with 3-dimensional blade.

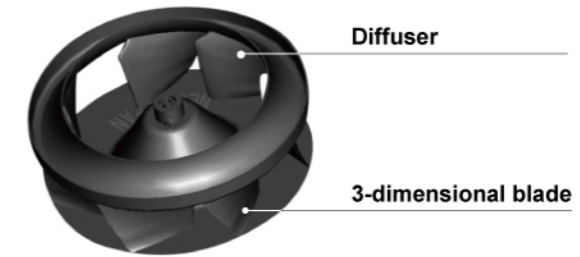

- ▶ Full-automatic operation, 4-way air supply, 3-speed fan setting and strong circulating air flow volume make the cooling or hot air directly reach every corner of the room, even if the ceiling is higher than standard height.
  - The unit below 7.1 kW is applicable to the height below 3m.
  - The unit above 8kW is applicable to the height below 4.5m.

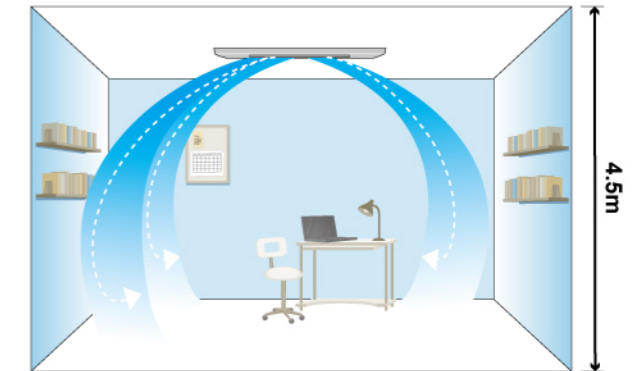

- ▶ Air supply in different directions with 30-60 degree sweep for even temperature distribution\*

Note:  
The guide louver defaults to min. position of 30° during cooling, dry and fan operation, or maximum position of 60° during heating operation.

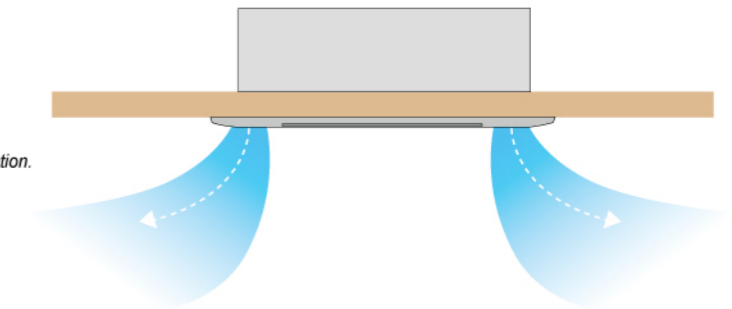

- ▶ Designed with fresh air baffle for fresh air introduction.
- ▶ Long life and washable filter.

## Four-Way Cassette Type

MODEL			GMV(L)-R28T/Na-K	GMV(L)-R36T/Na-K	GMV(L)-R45T/Na-K	GMV(L)-R50T/Na-K
Power supply			1-Phase, 220-240V, 50Hz			
Capacity	Cooling	kW	2.8	3.6	4.5	5.0
	Heating		3.2	4.0	5.0	5.8
Power consumption		W	65	65	65	65
Airflow rate	m³/h		680	680	680	680
	CFm		400	400	400	400
Sound pressure level (H/M/L)		dB(A)	37/35/34	37/35/34	37/35/34	37/35/34
Connection pipe	Gas (Flare)	inch	3/8	1/2	1/2	1/2
		mm	φ9.52	φ12.7	φ12.7	φ12.7
	Liquid (Flare)	inch	1/4	1/4	1/4	1/4
		mm	φ6.35	φ6.35	φ6.35	φ6.35
Drain pipe	External dia.	mm	φ30	φ30	φ30	φ30
	Thickness	mm	1.5	1.5	1.5	1.5
Main body	Dimensions (WxDxH)	mm	840×840×190			
	Net Weight	kg	25	25	25	25
Panel	Dimensions (WxDxH)	mm	950×950×60			
	Net Weight	kg	6.5	6.5	6.5	6.5

## Four-Way Cassette Type

MODEL			GMV(L)-R100T/Na-K	GMV(L)-R112T/Na-K	GMV(L)-R125T/Na-K	GMV(L)-R140T/Na-K
Power supply			1-Phase, 220-240V, 50Hz			
Capacity	Cooling	kW	10.0	11.2	12.5	14.0
	Heating		11.0	12.5	13.5	14.5
Power consumption		W	133	133	133	133
Airflow rate	m³/h		1860	1860	1860	1860
	CFm		1095	1095	1095	1095
Sound pressure level (H/M/L)		dB(A)	39/37/35	40/38/36	40/38/36	40/38/36
Connection pipe	Gas (Flare)	inch	5/9	5/8	5/8	5/8
		mm	φ15.9	φ15.9	φ15.9	φ15.9
	Liquid (Flare)	inch	3/8	3/8	3/8	3/8
		mm	φ9.53	φ9.52	φ9.52	φ9.52
Drain pipe	External dia.	mm	φ30	φ30	φ30	φ30
	Thickness	mm	4.5	1.5	1.5	1.5
Main body	Dimensions (WxDxH)	mm	840×840×320			
	Net Weight	kg	38	38	38	38
Panel	Dimensions (WxDxH)	mm	950×950×60			
	Net Weight	kg	6.5	6.5	6.5	6.5

MODEL			GMV(L)-R56T/Na-K	GMV(L)-R71T/Na-K	GMV(L)-R80T/Na-K	GMV(L)-R90T/Na-K
Power supply			1-Phase, 220-240V, 50Hz			
Capacity	Cooling	kW	5.6	7.1	8.0	9.0
	Heating		6.3	8.0	8.8	10.0
Power consumption		W	83	83	83	133
Airflow rate	m³/h		1180	1180	1180	1860
	CFm		695	695	695	1095
Sound pressure level (H/M/L)		dB(A)	39/37/35	39/37/35	39/37/35	39/37/35
Connection pipe	Gas (Flare)	inch	5/8	5/8	5/9	5/8
		mm	φ15.9	φ15.9	φ15.9	φ15.9
	Liquid (Flare)	inch	3/8	3/8	3/8	3/8
		mm	φ9.52	φ9.52	φ9.53	φ9.52
Drain pipe	External dia.	mm	φ30	φ30	φ30	φ30
	Thickness	mm	1.5	1.5	2.5	3.5
Main body	Dimensions (WxDxH)	mm	840×840×240		840×840×320	
	Net Weight	kg	30	30	30	38
Panel	Dimensions (WxDxH)	mm	950×950×60			
	Net Weight	kg	6.5	6.5	6.5	6.5

## Compact Four-Way Cassette Type

MODEL			GMV-R22T/NaA-K	GMV-R28T/NaA-K	GMV-R36T/NaA-K	GMV-R45T/NaA-K
Power supply			1-Phase, 220-240V, 50Hz			
Capacity	Cooling	kW	2.2	2.8	3.6	4.5
	Heating		2.5	3.2	4.0	5.0
Power consumption		W	12	12	12	12
Airflow rate	m³/h		600	600	600	600
	CFm		353	353	353	353
Sound pressure level (H/M/L)		dB(A)	47/44/41	47/44/41	47/44/41	47/44/41
Connection pipe	Gas (Flare)	inch	3/8	1/2	1/2	1/2
		mm	φ9.52	φ12.7	φ12.7	φ12.7
	Liquid (Flare)	inch	1/4	1/4	1/4	1/4
		mm	φ6.35	φ6.35	φ6.35	φ6.35
Drain pipe	External dia.	mm	φ30	φ30	φ30	φ30
	Thickness	mm	1.5	1.5	1.5	1.5
Main body	Dimensions (WxDxH)	mm	570×570×230			
	Net Weight	kg	25	25	25	25
Panel	Dimensions (WxDxH)	mm	650×650×50			
	Net Weight	kg	5	5	5	5

# ONE-WAY CASSETTE TYPE



## High flexible

Highly flexible installations for various needs.

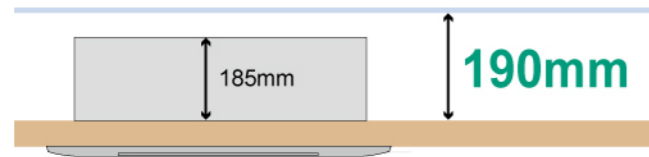

## Drain pump lift

Drain pump fitted as standard with increased lift of **700mm**.

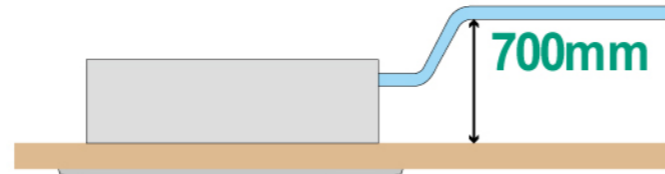

## The unit is applicable to the height below **3.5m**

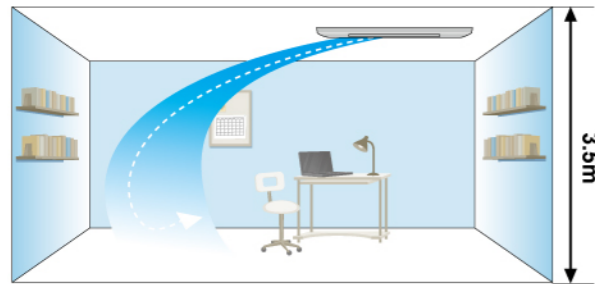

## Detachable and washable grille

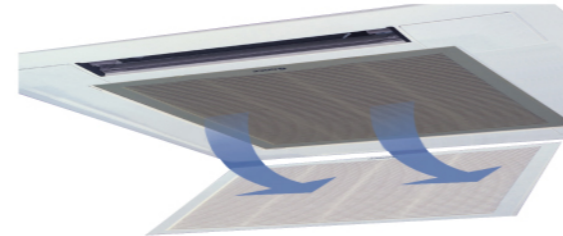

## Ultra quiet operation

Low-noise cross flow fan reduces vortex flow in the duct thus reducing the noise.

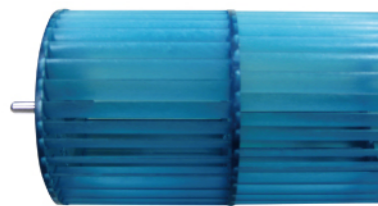

## Comfortable

Equal and gentle air supply design and advanced air flow controlling design make the room temperature equal and balanced, so that people feel more comfortable.

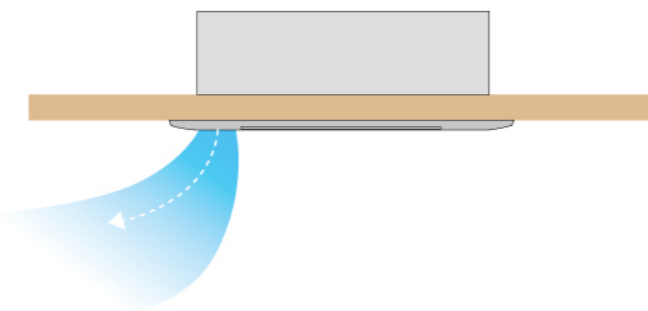

## Long life and washable filter

MODEL			GMV(L) - R22Td/NaA-K	GMV(L) - R28Td/NaA-K	GMV(L) - R36Td/NaA-K
Power supply			1-Phase, 220-240V, 50Hz		
Capacity	Cooling	kW	2.2	2.8	3.6
	Heating		2.5	3.2	4.0
Power consumption		W	42	42	42
Airflow rate		m <sup>3</sup> /h	450	500	500
		CFM	265	294	294
Sound pressure level		dB(A)	45	45	45
Connecting pipe	Gas (Flare)	inch	3/8	3/8	1/2
		mm	φ9.52	φ9.52	φ12.7
	Liquid (Flare)	inch	1/4	1/4	1/4
		mm	φ6.35	φ6.35	φ6.35
Drain pipe	External dia.	mm	φ30	φ30	φ30
	Thickness	mm	1.5	1.5	1.5
Main body		mm	920x360x185		
	Net Weight	kg	φ16	φ16	φ16
Panel		mm	1180x430x30		
	Net Weight	kg	3	3	3



# WALL MOUNTED TYPE



## Streamlined design for spaces without ceiling

## Anti cool air design

When heating in winter, intelligent anti cool air function is started. Unit only blows when inside the unit is pre-heated to prevent cool air from blowing out.

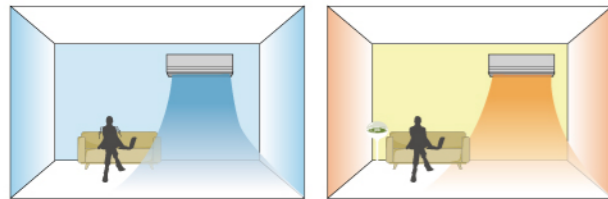

## Vertical auto swing

When cooling, cool air is directed across the room and then sinks. When heating, warm air is directed across the floor and then rises.

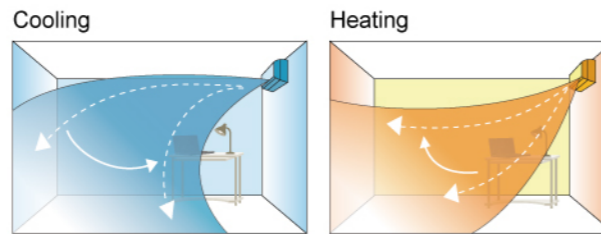

## Auto clean (under COOL & DRY mode)

After unit off, the indoor fan would still operate in low speed to dry the inner components and parts to prevent mould and odor growing.



## Low noise design

Advanced irregular-distance mixed flow fan, unique duct design and multi-grill auxiliary duct make the operation highly efficient and noise lower.

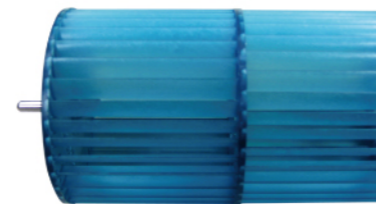

## Ternary filters

Ternary air filters with anti-mildew, static electric dust capture and anti-bacterial function.

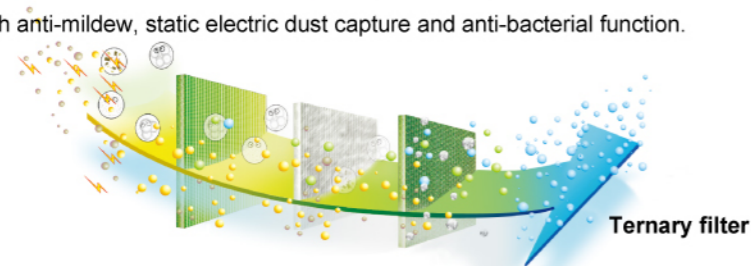

## Washable grille

The front grille can be easily removed for washing.

MODEL	GMV(L)-R22G/NaB-K	GMV(L)-R28G/NaB-K	GMV(L)-R36G/NaB-K	GMV(L)-R45G/NaB-K	GMV(L)-R50G/NaB-K	GMV(L)-R56G/NaB-K		
Power supply	1-Phase, 220-240V, 50Hz							
Capacity	Cooling	2.2	2.8	3.6	4.5	5.0	5.6	
	Heating	2.5	3.2	4.0	5.0	5.8	6.3	
Power consumption	W	32	32	48	48	56	58	
Airflow rate	m <sup>3</sup> /h	360	360	500	500	700	750	
	CFm	212	212	294	294	412	441	
Sound pressure level (H/M/L)	dB(A)	37/33/28	37/33/28	43/35/28	43/35/28	45/42/40	45/42/40	
Dimensions (W×D×H)	mm	770×190×250		830×189×285		1020×228×310		
Net weight	kg	8	8	11	11	15	15	
Connection pipe	Gas (Flare)	inch	3/8	3/8	1/2	1/2	5/8	
		mm	φ9.52	φ9.52	φ12.7	φ12.7	φ12.7	φ15.9
	Liquid (Flare)	inch	1/4	1/4	1/4	1/4	1/4	3/8
		mm	φ6.35	φ6.35	φ6.35	φ6.35	φ6.35	φ9.52
Drain pipe	External dia.	mm	φ20	φ20	φ20	φ20	φ30	
	Thickness	mm	1.5	1.5	1.5	1.5	1.5	
EXV Position	External							

MODEL	GMV(L)-R71G/NaB-K	GMV(L)-R80G/NaB-K	GMV(L)-R22G/NaG-K	GMV(L)-R28G/NaG-K	GMV(L)-R36G/NaG-K	GMV(L)-R45G/NaG-K		
Power supply	1-Phase, 220-240V, 50Hz							
Capacity	Cooling	7.1	8.0	2.2	2.8	3.6	4.5	
	Heating	8.0	9.0	2.5	3.2	4.0	5.0	
Power consumption	W	63	65	37	37	38	38	
Airflow rate	m <sup>3</sup> /h	1200	1200	500	500	630	630	
	CFm	706	706	294	294	371	371	
Sound pressure level (H/M/L)	dB(A)	49/45/42	49/45/42	38/36/34	38/36/34	44/41/38	44/41/38	
Dimensions (W×D×H)	mm	1178×227×326		843×180×275		940×200×298		
Net weight	kg	17.5	17.5	10.5	10.5	13	13	
Connection pipe	Gas (Flare)	inch	5/8	5/8	3/8	3/8	1/2	
		mm	φ15.9	φ15.9	φ9.52	φ9.52	φ12.7	φ12.7
	Liquid (Flare)	inch	3/8	3/8	1/4	1/4	1/4	1/4
		mm	φ9.52	φ9.52	φ6.35	φ6.35	φ6.35	φ6.35
Drain pipe	External dia.	mm	φ30	φ30	φ28	φ28	φ28	
	Thickness	mm	1.5	1.5	4	4	4	
EXV Position	External			Integrated				

MODEL	GMV(L)-R50G/NaG-K	GMV(L)-R56G/NaG-K	GMV(L)-R63G/NaG-K	GMV(L)-R71G/NaG-K		
Power supply	1-Phase, 220-240V, 50Hz					
Capacity	Cooling	5.0	5.6	6.3	7.1	
	Heating	5.8	6.3	7.0	8.0	
Power consumption	W	38	60	60	60	
Airflow rate	m <sup>3</sup> /h	630	800	800	800	
	CFm	371	471	471	471	
Sound pressure level (H/M/L)	dB(A)	44/41/38	44/41/38	44/41/38	44/41/38	
Dimensions (W×D×H)	mm	940×200×298		1008×221×319		
Net weight	kg	13	15	15	15	
Connection pipe	Gas (Flare)	inch	1/2	5/8	5/8	5/8
		mm	φ12.7	φ15.9	φ15.9	φ15.9
	Liquid (Flare)	inch	1/4	1/4	1/4	1/4
		mm	φ6.35	φ6.35	φ6.35	φ6.35
Drain pipe	External dia.	mm	φ28	φ28	φ28	φ28
	Thickness	mm	4	4	4	4
EXV Position	Integrated					

# FLOOR CEILING TYPE



## Compact and light weight

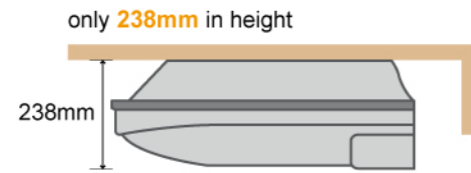

## Ultra quiet operation

## Long life and detachable and washable grille

## Easy to install and good looking, satisfies more requirements

## Easy maintenance

Convenient disassembly and maintenance thanks to unique design.

▶ Plastic filter with buckles

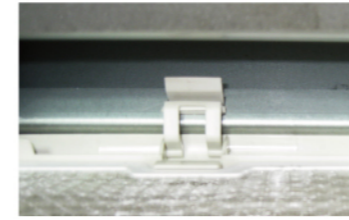

▶ Grill buckle

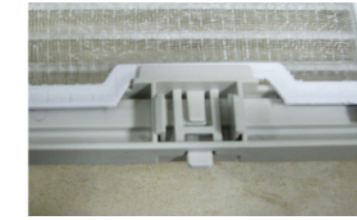

▶ Dismountable motor

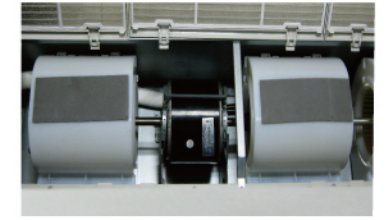

## Wide discharge range

With cross-direction sweep, the air supply range is efficiently wider.

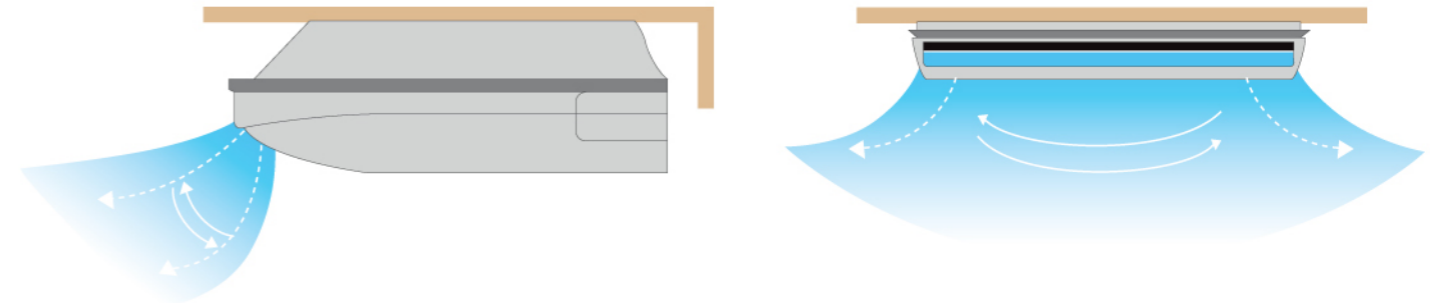

## Drain pump lift reaches 1100mm

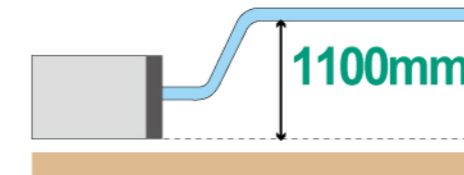

### Floor Ceiling (EXV Separated)

MODEL			GMV(L)-R28Zd/Na-K	GMV(L)-R36Zd/Na-K	GMV(L)-R50Zd/Na-K	GMV(L)-R71Zd/Na-K
Power supply			1-Phase, 220-240V, 50Hz			
Capacity	Cooling	kW	2.8	3.6	5.0	7.1
	Heating		3.2	4.0	5.8	8.0
Power consumption		W	22	22	90	220
Airflow rate	m³/h		550	600	700	1170
	CFm		324	353	412	689
Sound pressure level (H/M/L)		dB(A)	43/40/38	44/41/38	50/47/44	48/45/43
Dimensions (W×D×H)		mm	840×238×695			1300×188×600
Net weight		kg	28	28	28	33
Connection pipe	Gas (Flare)	inch	3/8	1/2	1/2	5/8
		mm	φ9.52	φ12.7	φ12.7	φ15.9
	Liquid (Flare)	inch	1/4	1/4	1/4	3/8
		mm	φ6.35	φ6.35	φ6.35	φ9.52
Drain pipe	External dia.	mm	φ17	φ17	φ17	φ17
	Thickness	mm	1.75	1.75	1.75	1.75

### Floor Ceiling (EXV Integrated)

MODEL			GMV(L)-R28Zd/NaB-K	GMV(L)-R36Zd/NaB-K	GMV(L)-R50Zd/NaB-K	GMV(L)-R71Zd/NaB-K
Power supply			1-Phase, 220-240V, 50Hz			
Capacity	Cooling	kW	2.8	3.6	5.0	7.1
	Heating		3.2	4.0	5.8	8.0
Power consumption		W	19	19	75	150
Airflow rate	m³/h		500	600	700	1500
	CFm		324	353	412	883
Sound pressure level (H/M/L)		dB(A)	43/40/38	44/41/38	50/47/44	48/45/43
Dimensions (W×D×H)		mm	980×700×225			1420×700×245
Net weight		kg	27	27	27	32
Connection pipe	Gas (Flare)	inch	3/8	1/2	1/2	5/8
		mm	φ9.52	φ12.7	φ12.7	φ15.9
	Liquid (Flare)	inch	1/4	1/4	3/8	3/8
		mm	φ6.35	φ6.35	φ9.52	φ9.52
Drain pipe	External dia.	mm	φ17	φ17	φ17	φ17
	Thickness	mm	1.75	1.75	1.75	1.75

MODEL			GMV(L)-R90Zd/Na-K	GMV(L)-R112Zd/Na-K	GMV(L)-R125Zd/Na-K
Power supply			1-Phase, 220-240V, 50Hz		
Capacity	Cooling	kW	8.0	11.2	12.5
	Heating		10.0	12.5	13.5
Power consumption		W	330	340	340
Airflow rate	m³/h		2100	2200	2300
	CFm		1236	1295	1354
Sound pressure level (H/M/L)		dB(A)	51/48/44	54/50/46	55/51/47
Dimensions (W×D×H)		mm	1590×238×695	1714×330×830	
Net weight		kg	44	44	44
Connection pipe	Gas (Flare)	inch	5/8	5/8	5/8
		mm	φ15.9	φ15.9	φ15.9
	Liquid (Flare)	inch	3/8	3/8	3/8
		mm	φ9.52	φ9.52	φ9.52
Drain pipe	External dia.	mm	φ17	φ17	φ17
	Thickness	mm	1.75	1.75	1.75

MODEL			GMV(L)-R90Zd/NaB-K	GMV(L)-R112Zd/NaB-K	GMV(L)-R125Zd/NaB-K	GMV(L)-R140Zd/NaB-K
Power supply			1-Phase, 220-240V, 50Hz			
Capacity	Cooling	kW	8.0	11.2	12.5	14.0
	Heating		9.0	12.5	13.5	16.0
Power consumption		W	200	300	300	300
Airflow rate	m³/h		1700	2000	2000	2000
	CFm		1000	1777	1777	1777
Sound pressure level (H/M/L)		dB(A)	51/48/44	54/50/46	54/50/46	54/50/46
Dimensions (W×D×H)		mm	1420×700×245	1700×700×245		
Net weight		kg	32	62	66	66
Connection pipe	Gas (Flare)	inch	5/8	5/8	5/8	5/8
		mm	φ15.9	φ15.9	φ15.9	φ15.9
	Liquid (Flare)	inch	3/8	3/8	3/8	3/8
		mm	φ9.52	φ9.52	φ9.52	φ9.52
Drain pipe	External dia.	mm	φ17	φ17	φ17	φ17
	Thickness	mm	1.75	1.75	1.75	1.75

# TREATED FRESH AIR DUCT TYPE



Provide fresh air of which temperature is close to the indoor ambient, ensure fresh and comfort of the indoor air.

Note: Capacity of fresh air ducted unit should be less than 30% of capacity of outdoor unit.



## Comfortable

- ▶ Make you feel comfortable like in the nature by introducing the outdoor fresh air after treatment into the room.
- ▶ Treated fresh air supplying temperature is close to indoor temperature (factory setting as 22 Celsius), reducing the cooling load of other indoor units.

## Easy control

- ▶ Wired remote control
- ▶ Long-distance monitoring
- ▶ Auto start after power recover
- ▶ Wireless remote control
- ▶ Sub-room switch
- ▶ Weekly timer
- ▶ Centralized control
- ▶ Memory function

## Flexible application

- ▶ The indoor unit with high static pressure can realize long-distance fresh air supply to all corners of the room, so it is greatly applicable to where there is high density of people.
- ▶ The standard static pressure is 200Pa, and optional range is 50~300Pa.



MODEL			GMV-R140P/Na(X1.2)-K	GMV-R224P/Na(X2.0)-M	GMV-R280P/Na(X2.5)-M	GMV-R280P/Na(X3.0)-M	
Power supply			220-50-1	380-50-3	380-50-3	380-50-3	
Capacity (At rated ES)P	Cooling	PW	14	22.4	28	28	
	Heating	kW	10	16	20	20	
Power input <sup>1</sup>	Cooling	PW	0.5	1.1	1.1	1.1	
	Heating	kW	0.5	1.1	1.1	1.1	
Air Flow Volume		CFm	706	1177	1472	1766	
		m <sup>3</sup> /h	1200	2000	2500	3000	
Sound pressure level (H/M/L)		dB(A)	42	47	48	51	
External Static Pressure	Rated	Pa	150	200	200	200	
	Range	Pa	50~150	50~200	50~200	50~200	
Dimensions (W×D×H)		mm	1463x756x300	1700x1100x650	1700x1100x650	1700x1100x650	
Weight		kg	49	130	150	150	
Connection pipe	Valve Connection Type		Flare Connection	Brazing Connection	Brazing Connection	Brazing Connection	
		Length	m	7.5	7.5	7.5	7.5
		Gas additional charge	g/m	54	54	54	54
		Liquid Pipe	inch	3/8	3/8	3/8	3/8
		Gas Pipe	inch	5/8	11/9	8/9	8/9

# CONTROL NETWORK SKETCH

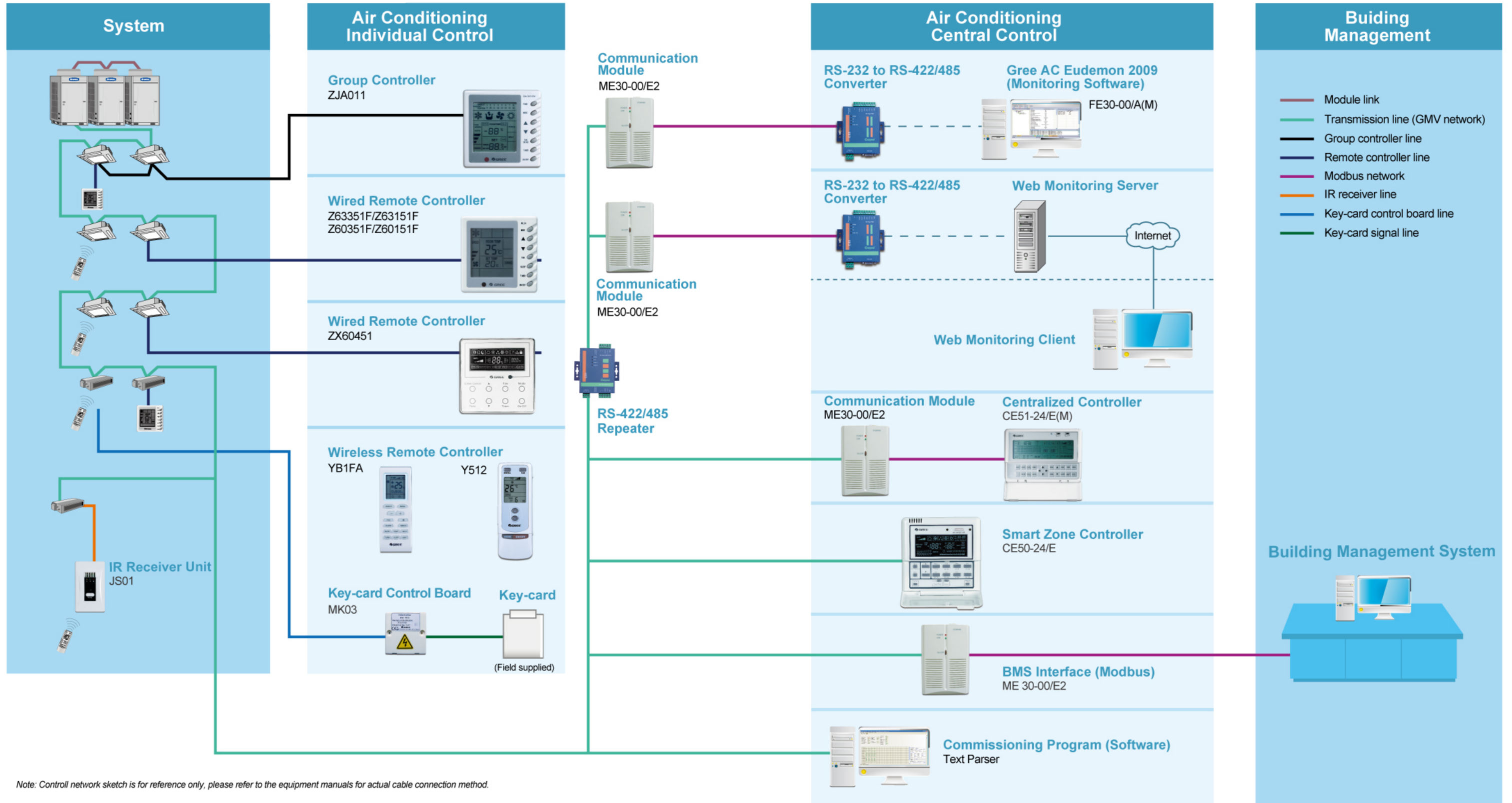

Note: Control network sketch is for reference only, please refer to the equipment manuals for actual cable connection method.



# CONTROLLERS COMPARISON

# COMMENTS OF CONTROL FUNCTIONS

ITEM		Wireless Remote Controller Y512	Wireless Remote Controller YB1FA	Wired Remote Controller Z63351FZ60351*	Wired Remote Controller XK02	Group Controller ZJA011	Smart Zone Controller CE50-24/E	Centralized Controller CE51-24/E(M)	Gree AC Eudemon 2009	BMS Interface (Modbus)
Connections	Max Nos. of Outdoor Units	—	—	—	—	—	—	64	n*255	n*255
	Max Nos. of Wired Controller	1	1	1	1	16	16	1024	n*255*16	n*255*16
	Max Nos. of Indoor Units	1	1	1	1	16	16	1024	n*255*16	n*255*16
Control Functions	ON/OFF	√	√	√	√	√	√	√	√	√
	Mode Setting	√	√	√	√	√	√	√	√	√
	Fan Speed	√	√	√	√	√	√	√	√	√
	Vertical Swing	√	√	√	√	√	√	√	√	√
	Energy Saving Mode	√	√	√	√				√	√
	Drying		√		√					
	Turbo Mode		√		√					
	Sleeping Mode	√	√	√	√				√	√
	Light	√	√							
Display	Errors			√	√	√	√	√	√	√
	Clock		√				√	√	√	
	Week						√	√	√	
	Room Temp.			√	√	√	√	√	√	√
	Lock		√	√	√	√	√	√	√	√
	Indoor Unit Address			√	√	√	√	√	√	√
Timer	ON/OFF Timer	√	√	√	√	√	√	√	√	
	Minimum Timer Gap	0.5h	1min	0.5h	0.5h	0.5h	0.5h	1min	1sec	
	Weekly Timer						√	√	√	
	Centralized Week Timer						√	√		
Shielding	Group Week Timer							√		
	Shielding			√	√	√	√	√	√	√
	Centralized Shielding					√	√	√		
Centralized Control	Group Shielding							√		
	Centralized Control					√	√	√	√	√
	Group Control							√		

Note:  
 • n: Nos. of serial port  
 • Control functions availability is based on the indoor units. Please refer to the user's manual of indoor unit for details.

## ON/OFF Timer Function

Under ON/OFF state, set the unit to be automatically turned on or turned off in 0.5n hours (1≤n<48).

## Error Display

When the malfunction occurs during the operation, the room temperature display area will show the error code.

The Picture here shows the code of compressor high-pressure protection.

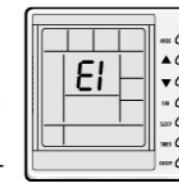

## Energy Saving Function

By setting the minimum value of setting temp. in cooling and defrosting mode as well as maximum value in heating mode, the unit can operate in smaller temp. range so as to save energy.

## Sleeping Function

Automatically correct the set temperature to prevent excessive cooling or heating during sleep.

In cooling or defrosting mode, the set temperature will automatically increase 2°C in 2 hours (1°C per hour) and then the unit will operate at such temperature.

In heating mode, the set temperature will automatically decrease 2°C in 2 hours (1°C per hour) and then the unit will operate at such temperature.

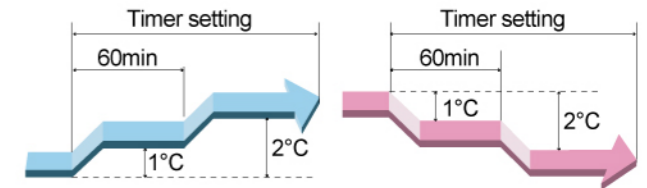

Note: There is no SLEEP function in FAN mode.

## Switch between Fahrenheit and Celsius Scale

Under OFF state, press MODE and ▼ buttons simultaneously to switch between °C and °F.

## Turbo Function ( In COOL or HEAT mode )

The unit operates at super-high fan speed so as to cool or heat quickly so that the ambient temperature approaches the set temperature as soon as possible.

When discrepancy between room temperature and set temperature is not more than 2°C, this function will be turned off automatically.

## Shield Function ( Remote monitoring )

Remote control the indoor unit and shield the functions of wired controller which includes ON/OFF, temp. or mode setting, energy-saving function, etc.

## Memory Function

After power failure, if the unit is energized again, it will operate according to previous set which include setting temp, fan speed, swing angle, energy-saving mode, blow function etc.

## Blow Function ( Only for cooling and heating mode )

When the unit is turned off, the indoor fan will keep running at low speed for 10 min to blow the indoor evaporator dry in order to prevent mildew and keep users healthy.

This function can be memorized.

## Mute Function ( Only for cooling and heating mode )

Common mute function: the unit automatically operates at low speed and the fan speed can't be adjustable at that time.

Auto mute function: The unit will enter mute operation according to discrepancy between room temperature and setting temperature. At that time, fan speed can be manually turned down.

# WIRED REMOTE CONTROLLER

Z60351F/ Z63351F (Heat pump)  
Z60151F/ Z63151F (Cooling only)



- ON/OFF
- Temperature setting
- Fan speed setting
- Energy-saving function
- Room temperature display
- Sleep function
- Infrared remote control function is available and the remote controller is optional
- ON/OFF Timer
- Operation mode setting
- Vertical swing
- Self-diagnosis function (Error code display)
- Memory function
- Child lock function

# WIRED REMOTE CONTROLLER

ZX60451



- ON/OFF
- Displayed as white characters on black background
- Fan speed setting
- Self-diagnosis function (Error code display)
- Turbo cooling/heating function
- Quiet function
- Enquire and setting address of wired controller
- ON/OFF Timer
- Temperature setting
- Vertical swing
- Environmental temperature display
- Evaporating function
- Shield function
- Infrared remote control function is available and the remote controller is optional.
- Touchable wired controller
- Operating mode setting
- Energy saving function
- Sleep function
- Memory function
- Child lock function

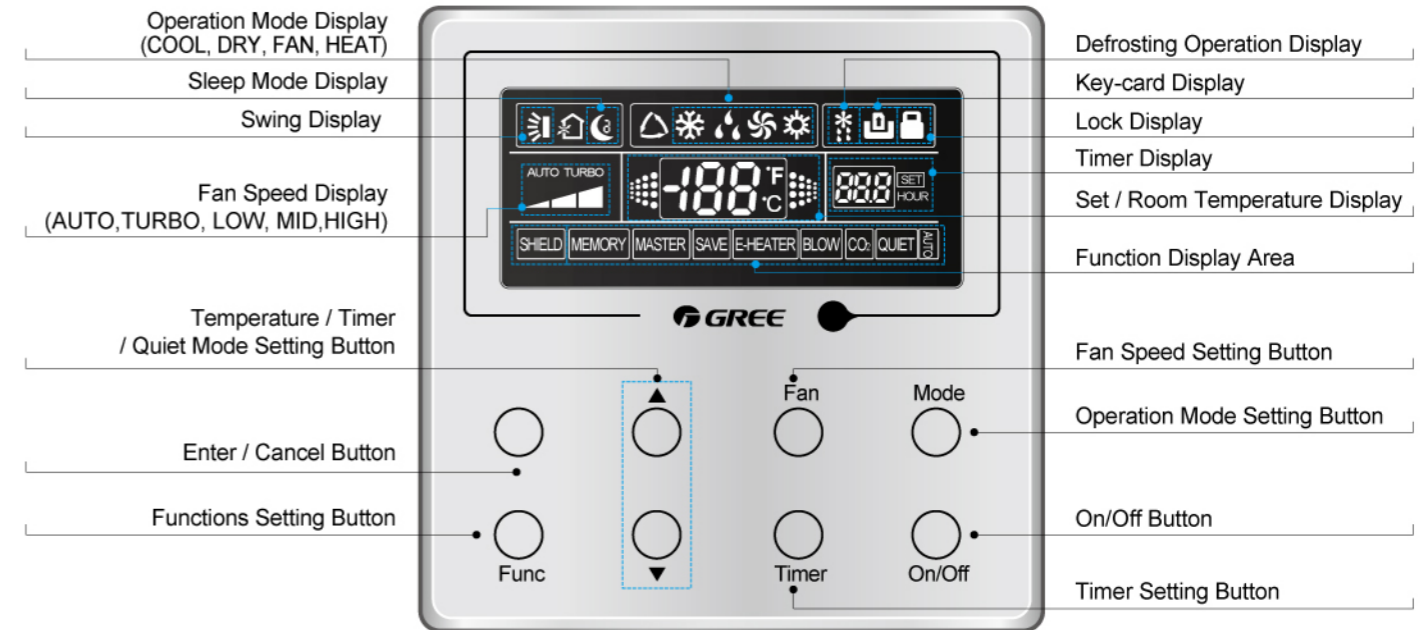
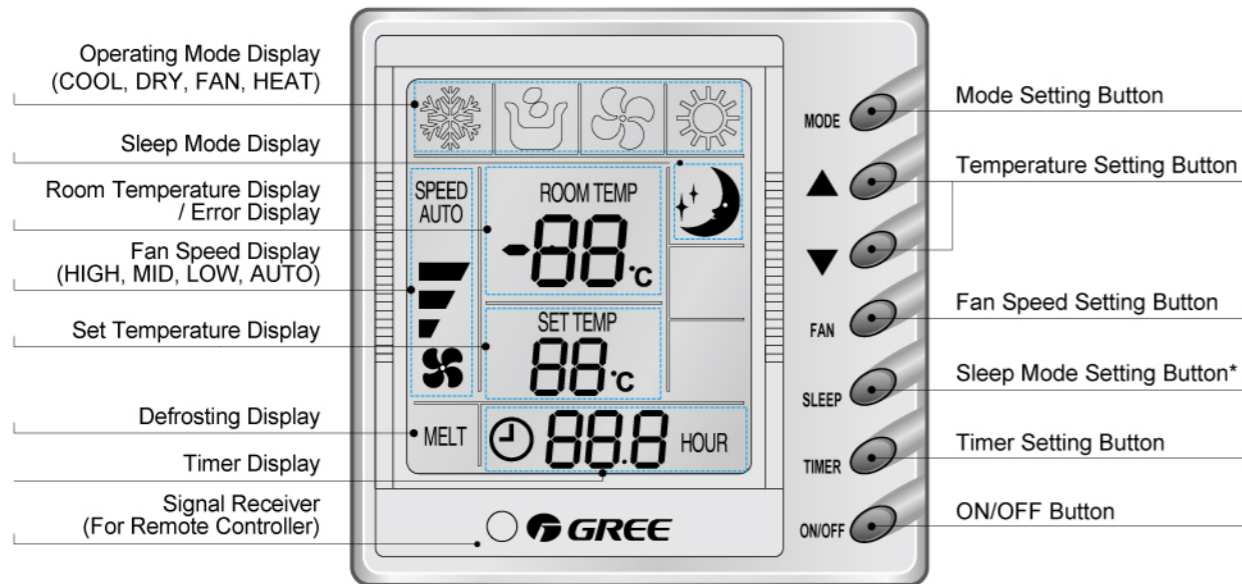

Model Name	Z63351F / Z63151F / Z60351F / Z60151F
Power Supply	DC12V (Supplied by the indoor unit)
Dimensions (H×W×D) (mm)	85×85×20
Weight (g)	94

Model Name	ZX60451
Power Supply	DC12V (Supplied by the indoor unit)
Dimensions (H×W×D) (mm)	92×92×24
Weight (g)	116

\* Z60351F/Z60151F is for duct type indoor unit, and swing function is unavailable;  
Z63351F/Z63151F is for other types of indoor unit, button "SLEEP" changes to "SWING"; and sleep function is unavailable.

# WIRELESS REMOTE CONTROLLER

Y512

- ON/OFF
- Temperature setting
- Fan speed setting
- Child lock function
- ON/OFF Timer
- Operation mode setting
- Vertical swing
- Sleep function



# WIRELESS REMOTE CONTROLLER

YB1FA

- ON/OFF
- Temperature setting
- Fan speed setting
- Energy-saving function
- Room temperature display
- Turbo cooling/heating function
- Mute function
- Child lock function
- ON/OFF Timer
- Operation mode setting
- Vertical swing
- Self-diagnosis function (Error code display)
- Sleep function
- Blow function
- Memory function (Turbo, Energy save, Quiet, Evaporation, etc)
- Clock display



Model Name	Y512
Power Supply	AAA 1.5V×2
Dimensions (H×W×D) (mm)	159×56×18
Weight (g)	92



Model Name	YB1FA
Power Supply	AAA 1.5V×2
Dimensions (H×W×D) (mm)	122×44×21
Weight (g)	70

# GROUP CONTROLLER

ZJA011

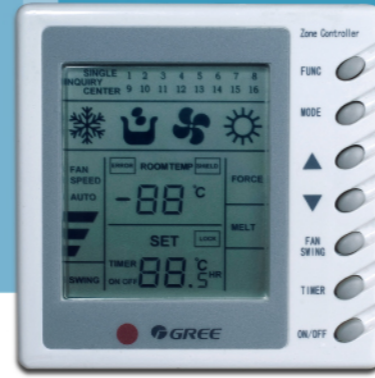

## Group monitoring control and group wired control are the two main control functions for group Controller.

Group monitoring controller can monitor or control 16 indoor units of a group for inquiry and single or centralized control.

### Features:

- Both single control and central control to 1-16 indoor units in a region are available.
- The wired controller buttons of 16 indoor units in a region can be shielded or locked.
- It can time 16 indoor units in a region.
  - It has the function of power-off memory.

Note: Wired controller must be reserved with which indoor unit has matched.

Group wired controller can replace 1-16 selected wired controllers to uniformly set or control the indoor units.

### Features:

- It can uniformly time the selected indoor units.
  - It has the function of power-off memory.
- It can replace wired controller to control selected indoor units in a region.

Note: Wired controller matched with indoor unit must be removed and indoor unit must be re-energized after debugging.

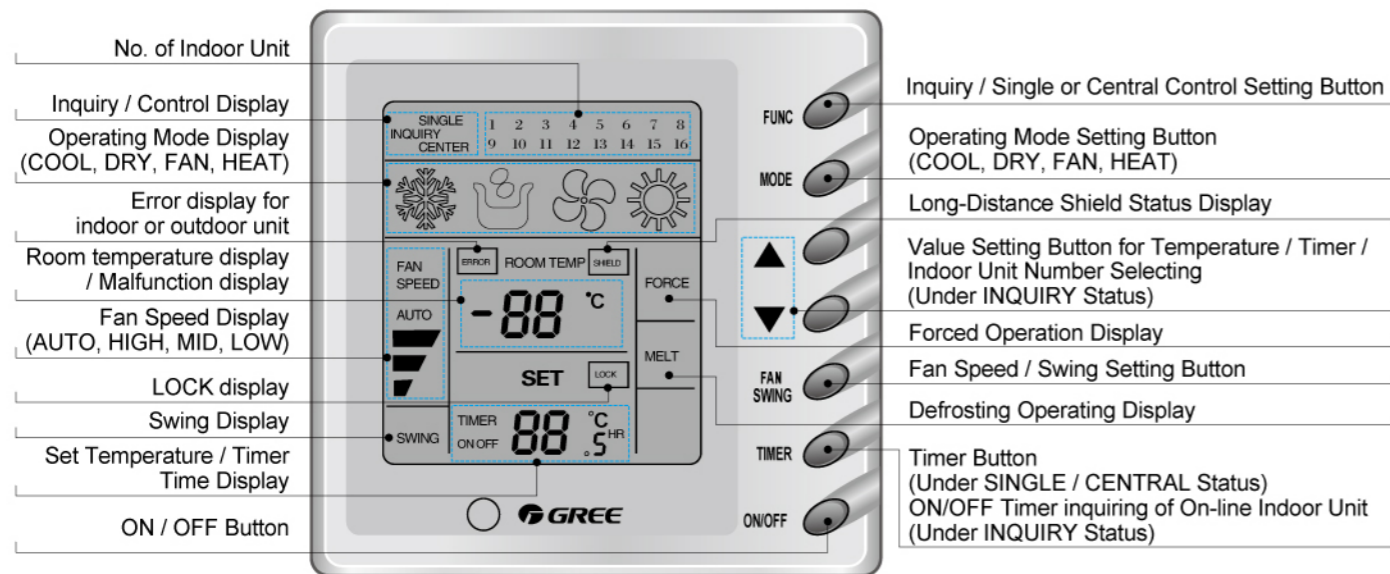

Model Name	ZJA011
Power Supply	DC12V (Supplied by the indoor unit)
Dimensions (H×W×D) (mm)	85×85×20
Weight (g)	94

# SMART ZONE CONTROLLER

CE50-24/E



- Indoor units connecting to 3 sets of GMV outdoor units and the air duct type indoor unit can be connected.
- Directly control 16 indoor units in the network without extra communication module.
- Operation status of any one operating indoor unit in its control group can be inquired and displayed.
- Single unit control and centralized control are available.
- Remote shield function.
- Timer function.
  - Weekly Timer Function.

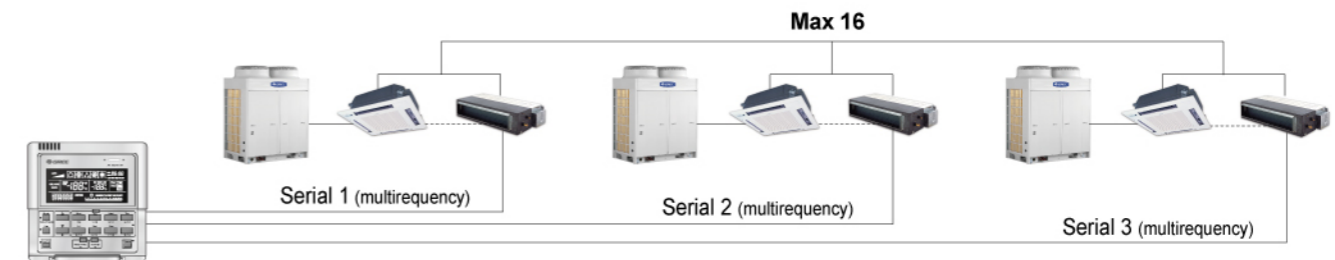
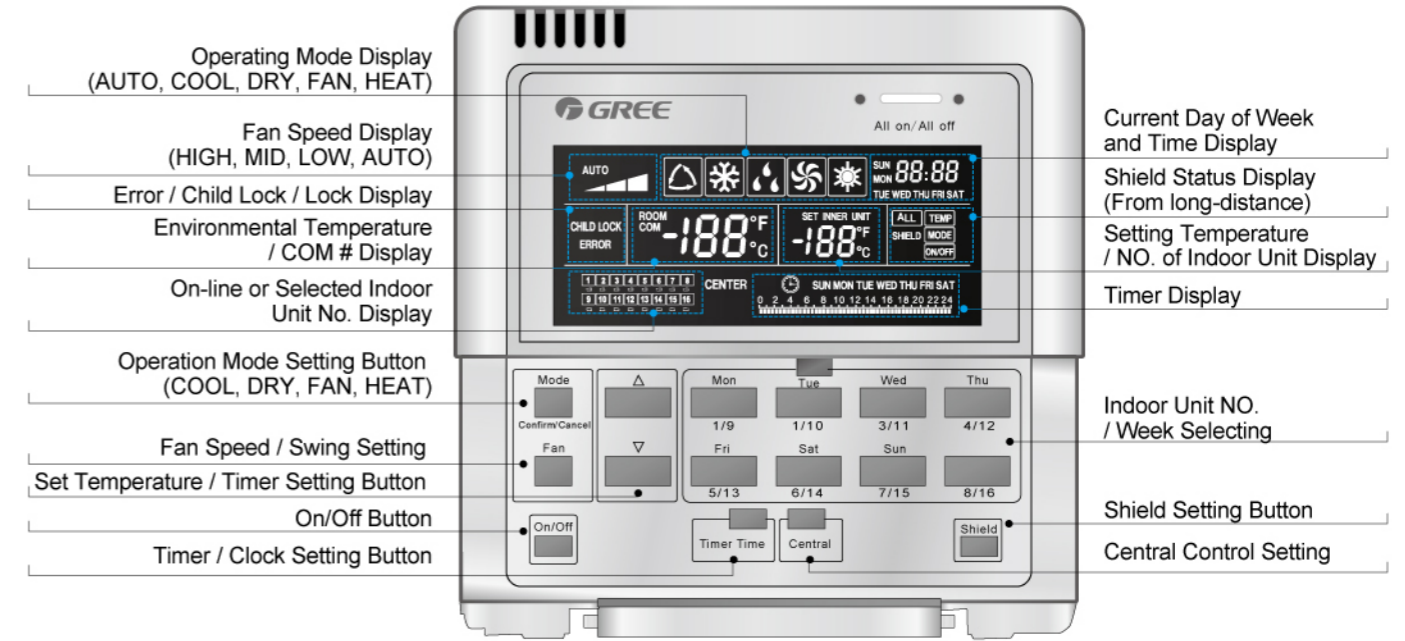

Model Name	CE50-24/E
Power Supply	220V~240V, 50/60 Hz
Dimensions (H×W×D) (mm)	120×120×62
Weight (g)	391

# CENTRALIZED CONTROLLER

CE51-24E/(M)



- Clock setting
- Error alarm and error code display
- Single/Group/Center Control (including weekly timer setting, shield setting, etc.)
- 64 communication modules can be connected and 1024 sets of indoor units can be controlled
- Inquire and control the ON/OFF, operation mode, set temperature, fan speed, swing state, etc. of indoor unit
- Automatically detect and display the status of online "region" and indoor unit (including operation mode, set temperature, fan speed, swing, weekly timer, shield, etc.)
- Long-distance shield function
- Up to 1km communication wires without repeaters

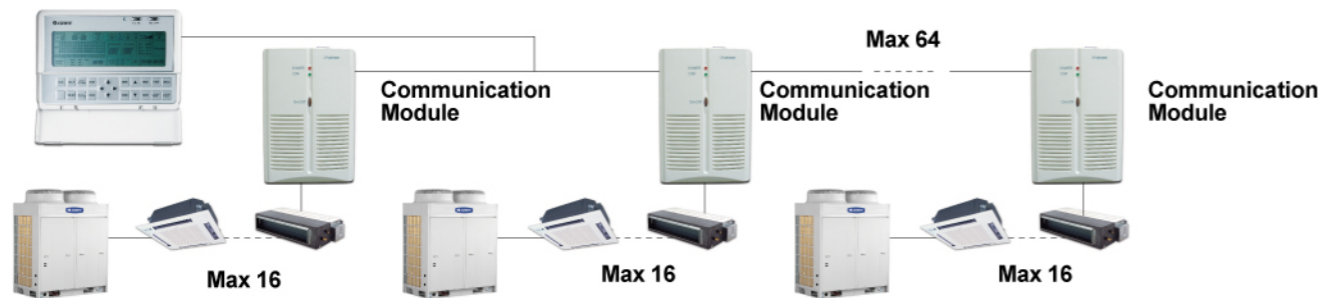
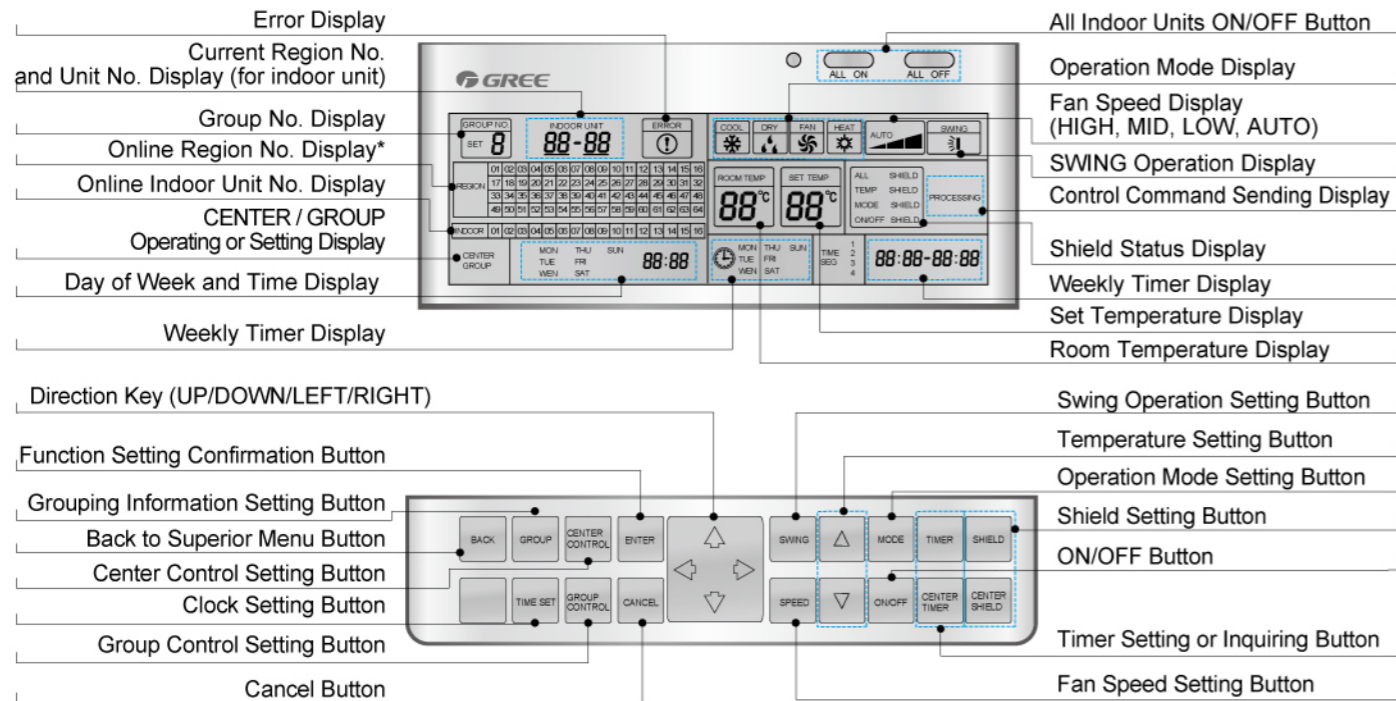

\* All indoor units connected by one communication module are automatically distributed in one region.

Model Name	CE51-24E/(M)
Power Supply	220V~240V, 50/60 Hz
Dimensions (H×W×D) (mm)	185×131×68
Weight (g)	557

# IR RECEIVER & KEY-CARD CONTROL BOARD

JS01 / MK03

## IR Receiver

JS01

It is applicable to GMV duct type indoor unit and equipped with LED lamp for status indication and infrared remote control function.

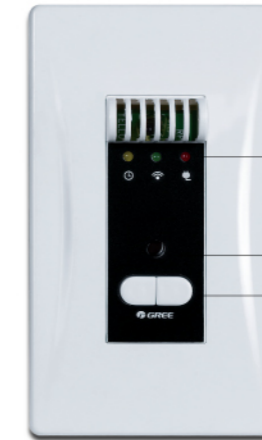

LED Lamp

Signal Receiver: it is used for receiving command sent from remote controller.

Heating ON/OFF and Cooling ON/OFF

Model Name	JS01
Power Supply	DC5V (Supplied by the indoor unit)
Dimensions (H×W×D) (mm)	120×70×58.5
Weight (g)	172

## Key-card Control Board

MK03

- This detection control board is only suitable for Gree multi-variable (GMV) indoor unit with gate-control function.
- The AC will operate after plugging in gate-control card and stop operating after pulling out the card.
- Upon pulling out the card to stop the unit, the running states of the unit will be memorized.
- After plugging in the card, the unit will be under standby state or resume running according to settings.
- The AC will operate when the customer plugs in the card and automatically stop when he pulls out the card, which ensures unit to be turned off after people leaves room and energy to be saved.



Model Name	MK03
Power Supply	220V~240V, 50/60Hz or DC5V~24V (Supplied by the indoor unit)
Dimensions (H×W×D) (mm)	73×73×36
Weight (g)	65

# COMMUNICATION MODULE

ME30-00/E2



# COMMISSIONING PROGRAM

Text Parser

## Functions

- ▶ The communication module (ME30-00/E2) is used for transforming and transmitting signals of the computer and the air conditioning system. It acts as a communication controller.
- ▶ Modbus protocol and RS485 interface are adopted so that the unit can be connected to user's BMS system and other networks.
- ▶ Lots of monitoring nodes make it possible to have as many as 255 units in the same network.
- ▶ Control of setting parameter is available.
- ▶ Monitoring of operation state is available.
- ▶ Monitoring of malfunction state is available.

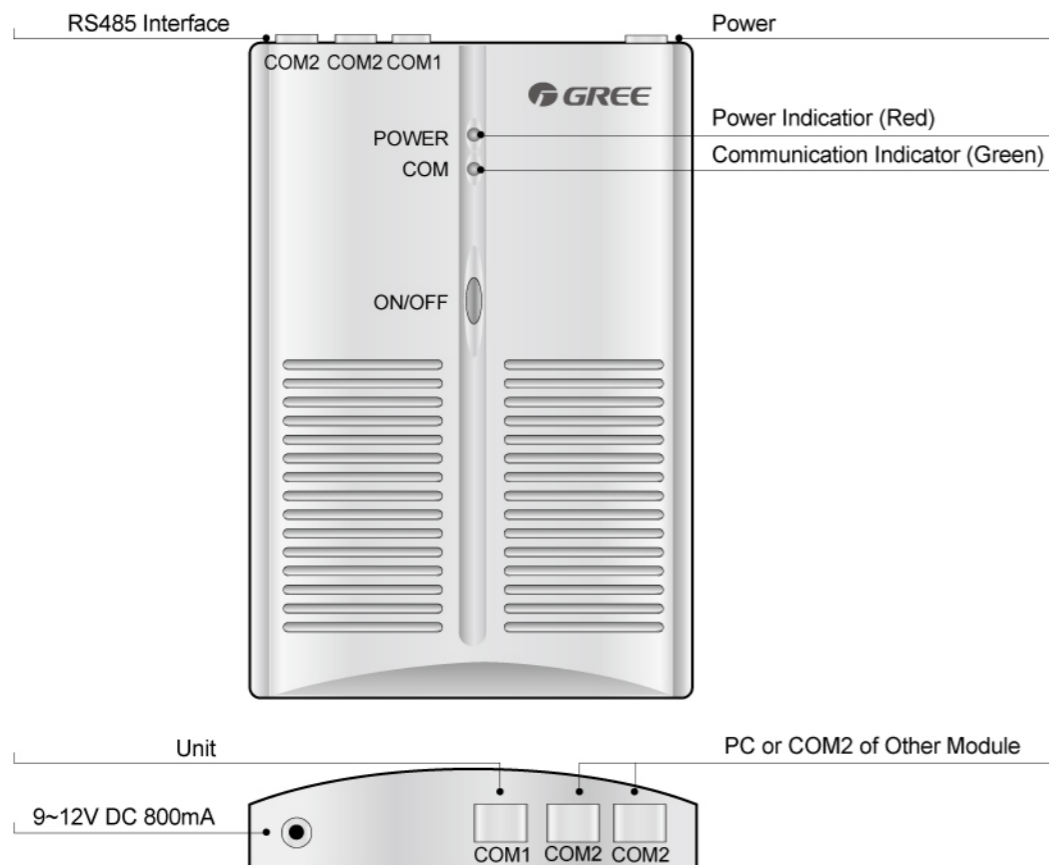

Model Name	ME30-00/E2
Power Supply	220V~240V, 50/60 Hz
Dimensions (H×W×D) (mm)	185×131×68
Weight (g)	557

## Brief introduction

- ▶ This software receives data from the GMV system through local COM port or network (both Internet and LAN are suitable) and then analyzes these data according to communication protocol.
- ▶ Running parameters of unit after analysis will be displayed and saved in real time. There are two kinds of displaying methods which are text displaying and curve displaying. The analytic data can be saved in database. Technician and service person can use this software to do the commissioning.

### Real-time parameter display

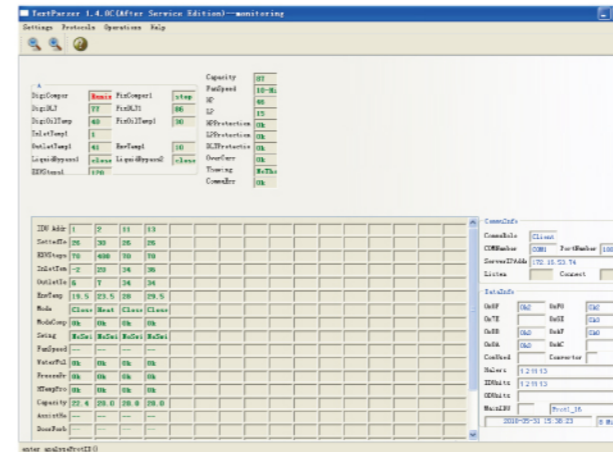

### Curves Analysis

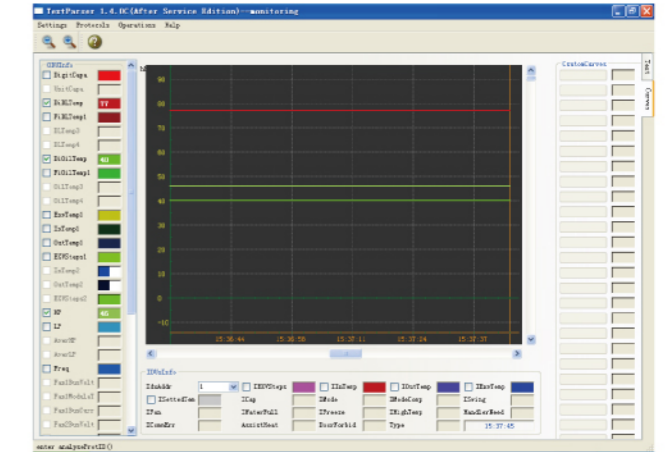

### Operating System

Microsoft® Windows® 2000 Professional (English version / Service pack 4 or later)  
 Microsoft® Windows® XP Professional (English version / Service pack 2 or later)  
 Microsoft® Windows Vista® Home Premium / Business / Enterprise / Ultimate  
 Microsoft® Windows® 7 Home Premium / Business / Enterprise / Ultimate  
 64-bit version of Windows® are not supported.

### CPU

Intel® Pentium® / Celeron®, AMD® Athlon™ / Duron™ 1 GHz or higher

### HDD

4 GB or more of free space

### Memory

512MB or more

# RS-422/485 REPEATER (ISOLATED)



## Functions

RS-422/485 Repeater (isolated) is used to amplify the communication signal when the quantity of communication modules in the network is more than 30, or communication distance is longer than 800m.

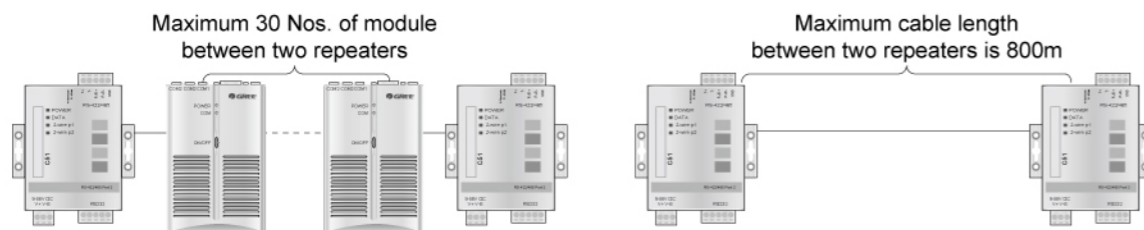
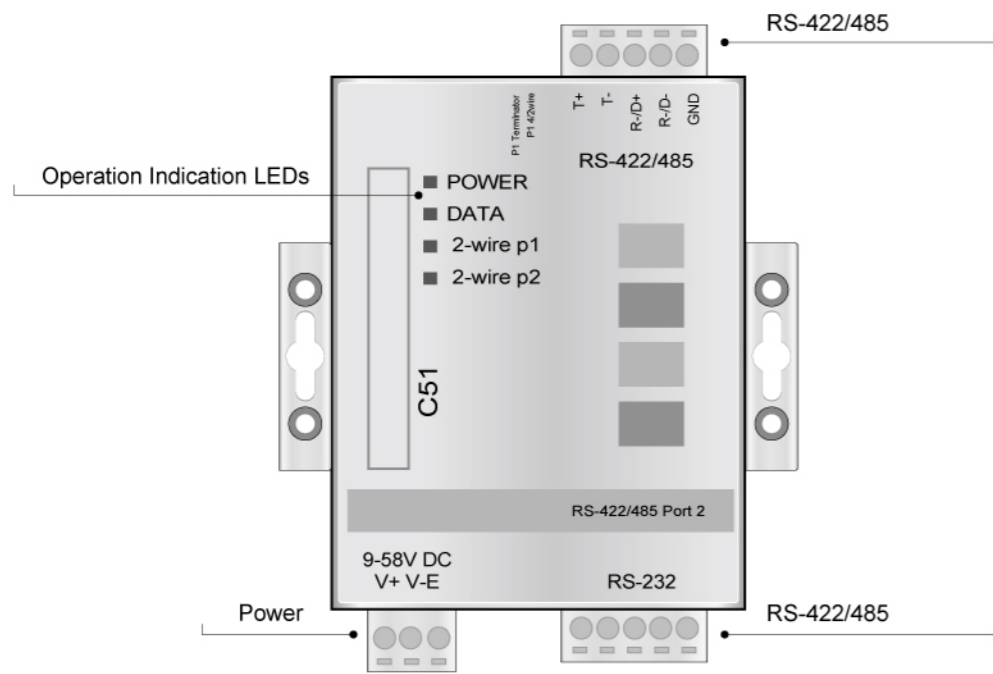

Power Supply	Input AC 220V~50/60HZ Output 12~30V DC 800mA
Dimensions (H×W×D) (mm)	96 x 100.6 x 25
Weight (g)	277

# RS-232 TO RS-422/485 CONVERTER (ISOLATED)



## Functions

RS232-RS485 optoelectronic isolated converter is used for converting the signal between computer / BMS System (RS232) and Gree Air Conditioning Systems (RS485).

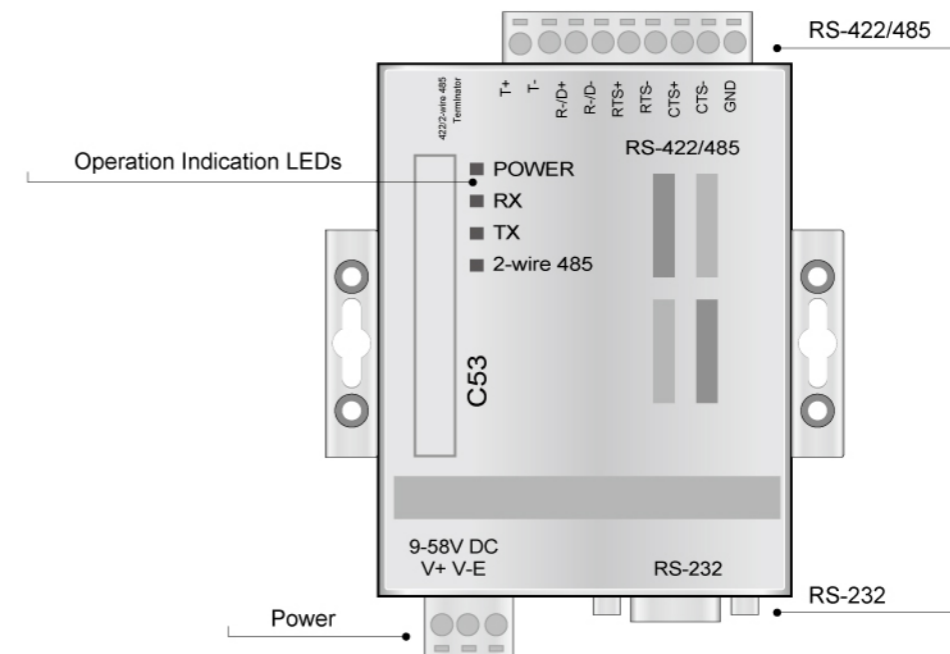

Power Supply	Input AC 220V~50/60HZ Output 12~30V DC 800mA
Dimensions (H×W×D) (mm)	96 x 100.6 x 25
Weight (g)	263

# GREE AC EUDEMON 2009 PC SUIT

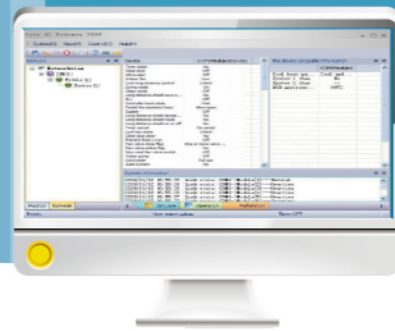

## Brief of Gree AC Eudemon 2009

Gree AC Eudemon 2009 is the latest solution for controlling, monitoring and management of GREE central air conditioning systems with your PC.

- ▶ Maximum Connectable Systems/Outdoor Units: 255
- ▶ Maximum Connectable Indoor Units (GMV System): 4,000
- ▶ Maximum Control Distance: 5,600 m (Standard distance 800m & extendable to 5.6km)
- ▶ Compatible Systems: GMV System, Centrifugal Chiller, Water-cooled screw chiller, Air-Cooled screw chiller, Air-cooled scroll chiller, etc.

## System schematic plan

Gree AC Eudemon 2009 Management System/BMS Network Schematic Plan

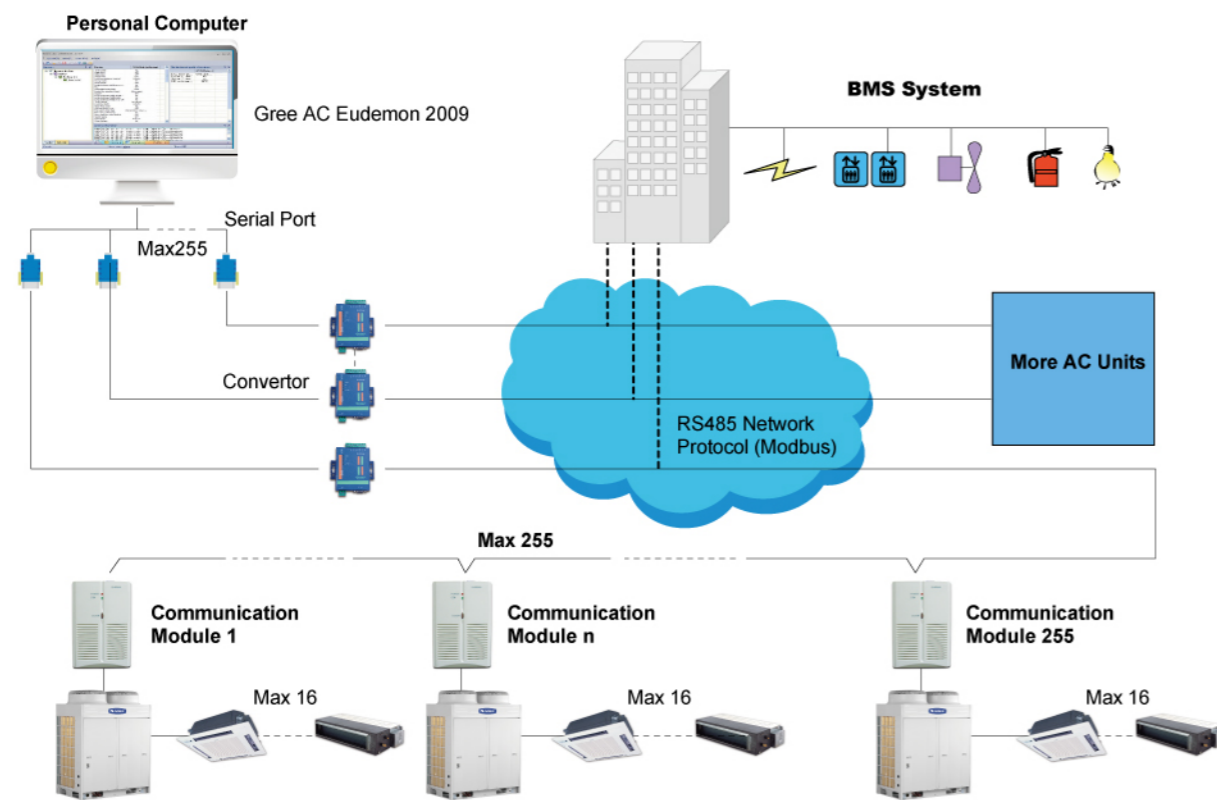

Note:

- In a RS485 Network, different type of systems can not be connected.
- User can only choose either Gree AC Eudemon 2009 or BMS (Modbus) to manage the Air-conditioner system.

## Functions of Gree AC Eudemon 2009

- ▶ Air Conditioning System running status / error information checking.
- ▶ Air Conditioning System Operation Parameter setting.
- ▶ Multi User Management with different authorized levels.
- ▶ Intelligent Timer with simplified schedule management.
- ▶ Multi Serial port and Multithreading Monitoring.
- ▶ Automatic Detection enables quick monitoring even if the user is not familiar with the concept of equipments, protocol and models, etc.
- ▶ Vivid network plan helps the easy understanding of the physical structure of the air conditioning system.
- ▶ Vivid location plan helps easy management of the air conditioning system.

## Content of Gree AC Eudemon 2009

Model Name	Gree AC Eudemon 2009 FE30-00/A(M)
Content	Gree AC Eudemon 2009 CD-ROM x 1 PCS RS232-RS485 Optoelectronic Isolated Converter x 1 PCS

## Requirement of PC for Gree AC Eudemon 2009

Operating System	Microsoft® Windows® XP Professional (English version / Service pack 2 or later) Microsoft® Windows Vista® Home Premium / Business / Enterprise / Ultimate Microsoft® Windows® 7 Home Premium / Business / Enterprise / Ultimate 64-bit version of Windows® are not supported.
CPU	Intel® Pentium® / Celeron®, AMD® Athlon™ / Duron™ 1 GHz or higher
HDD	10 GB or more of free space
Memory	1 GB or more
Software Environment	Internet Explorer® 6.0 SP1 or later (.NET Framework supported) Microsoft® .NET Framework® 2.0 Microsoft® SQL Server® 2005 Express Microsoft® Data Access Components (MDAC) 2.8 SP1 or later. Microsoft Visual C++® 2008 Redistributable SP1



# PIPING DESIGN PROGRAM

## GMV SELECTOR



### Brief introductions

- ▶ Gree GMV Selector is a program for doing the piping design of GMV VRF systems.



- ▶ Interface of the main program

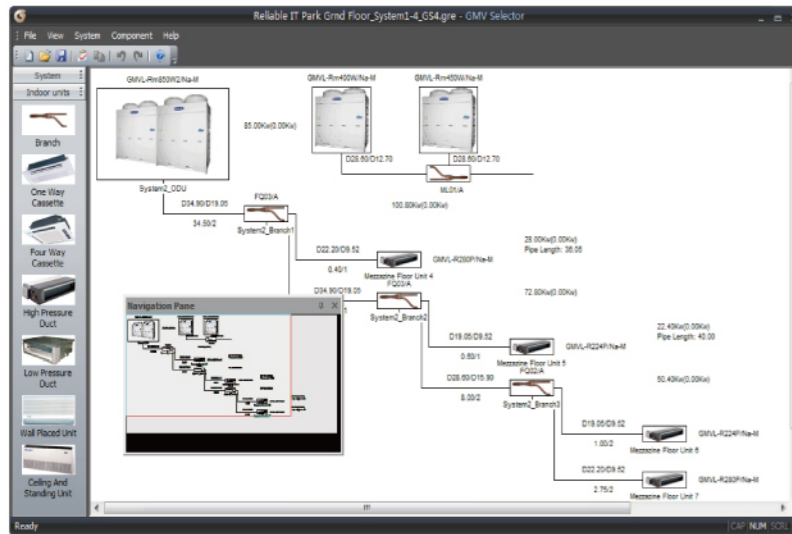

### The software provides two ways to output the design

- ▶ Excel summary files: it consists of the equipment summary, design condition, system details and remote monitor detail.
- ▶ Auto CAD drawings: Electrical & Communication wiring design of the system.

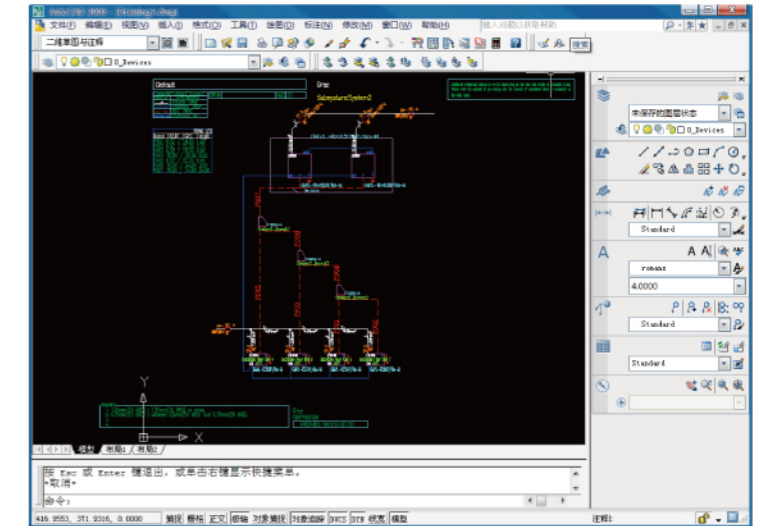
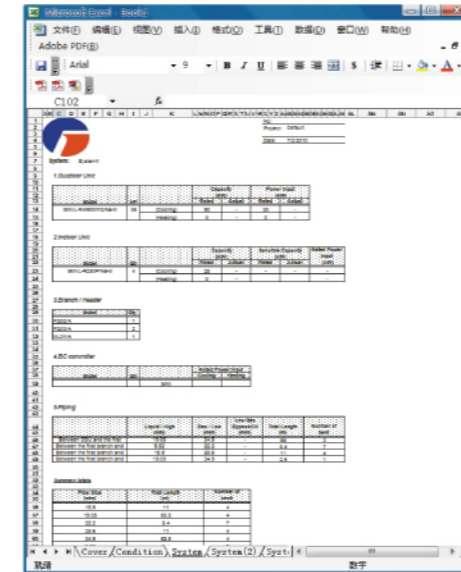

Operating System	Microsoft® Windows® 2000 Professional (English version / Service pack 4 or later) Microsoft® Windows® XP Professional (English version / Service pack 2 or later) Microsoft® Windows Vista® Home Premium / Business / Enterprise / Ultimate Microsoft® Windows® 7 Home Premium / Business / Enterprise / Ultimate 64-bit version of Windows® are not supported.
CPU	Intel® Pentium® / Celeron®, AMD® Athlon™ / Duron™ 1 GHz or higher
HDD	4 GB or more of free space
Memory	512 MB or more
Software Environment	Autodesk® AutoCAD® 2004 / 2005 / 2008 Microsoft Office® Excel 2000/2003/2007 Professional Microsoft Visual C++® 2008 Redistributable SP1

# ENERGY RECOVERY VENTILATION

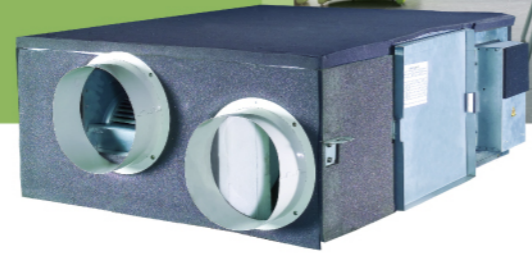

Introducing outdoor fresh air and discharging indoor air, make you feel comfortable as in the nature.

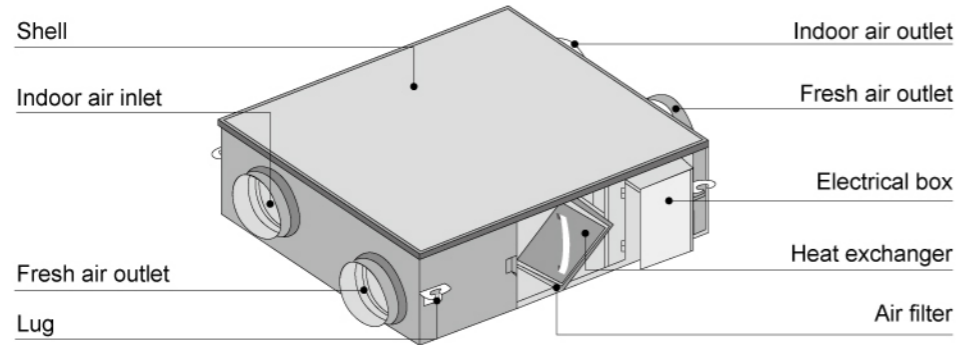

## Energy saving

- Internal heat exchanger performs cooling and heating exchange between the discharged air and fresh air. Energy-recovery rate above **70%**, highly energy saving.

- Unique by-pass mode can reduce power consumption of fan motor to prolong lifetime of heat exchanger core. By the combination of heat exchange mode and by pass mode, the unit load can reduce by about **26%** in a year.

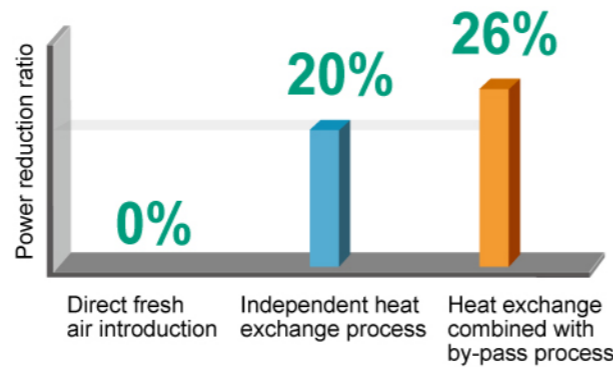
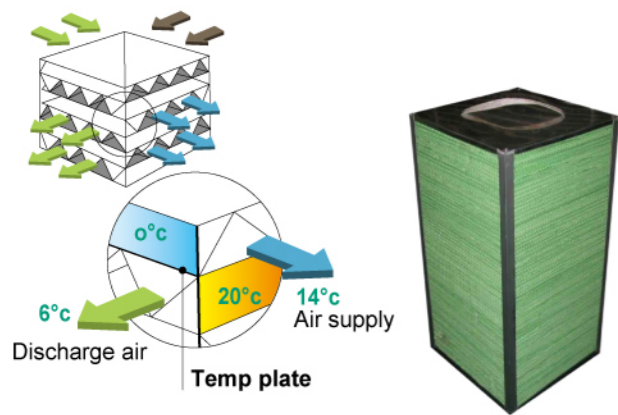

### Heat exchange mode

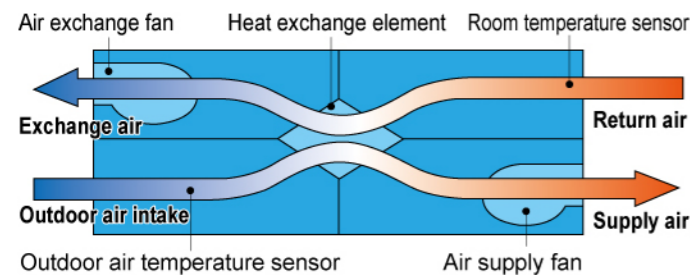

### By-pass mode

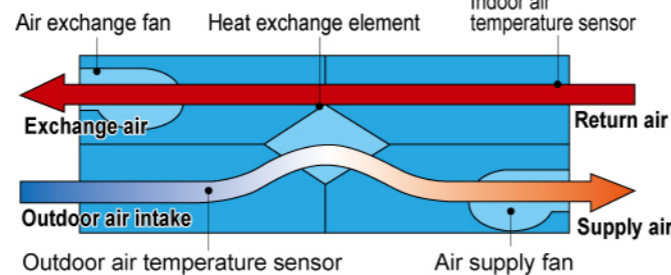

## High efficiency heat exchange

The ERV can exchange the latent heat and sensible heat simultaneously, which can adjust temperature and humidity at the same time. It can be widely applied where there is big humidity difference between indoor and outdoor.

### Heat exchange (sensible heat) inside the core

Heat exchange between discharged air and fresh air, so that the fresh air temperature comes down and close to the indoor temperature. Avoiding the feeling of uncomfortable and meanwhile effectively decreasing the load of air conditioning.

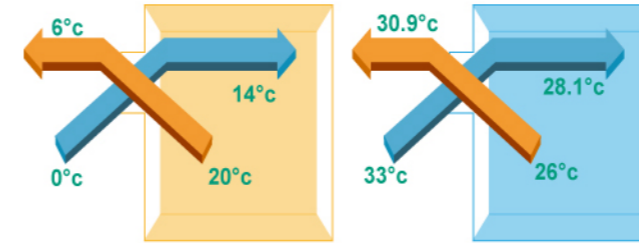

### Exchange of humidity (latent heat)

The vapor on the side with high humidity is absorbed by hygroscopic agent and discharged to the side with low humidity through capillary action of the fiber.

Through heat exchange between the indoor air and fresh air, the internal heat exchanger reduces the fluctuation of indoor temperature and prevents high supply air temperature difference while reducing operation load of the unit.

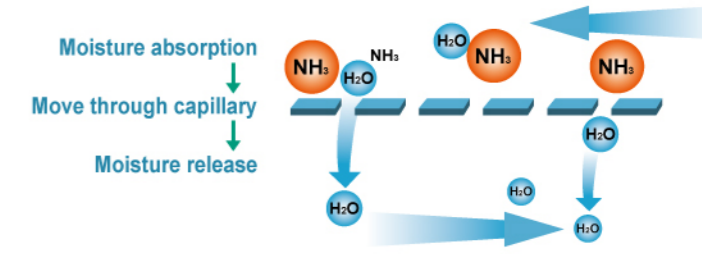

### Air Filtration and purification Function

- Internal air filter keeps the fresh air introduced into room pure and dustless.
- The efficient isolation between fresh air duct and discharge air duct ensures pure air supply.
- With antibacterial and anti-mildew materials, the heat exchange core is suiting for healthy.

### Wide range of models

7 models in a range of **350~3000m³/h**, which can fit for different spaces and reduce the waste of power. Wide range from **350 to 3000m³/h**, matching with the buildings of various structures.

### Flexible control

- LED display
- Energy saving mode
- 24h** timer
- Centralized controller
- Weekly timer
- Long-distance Monitoring Control (optional)

### Reliability and easy maintenance

- The complete unit with non-moving parts except the fan motor can reliably operate for a long period of time, without frequent maintenance.
- Filter and heat exchange core can be easily take out from the access door for cleaning.

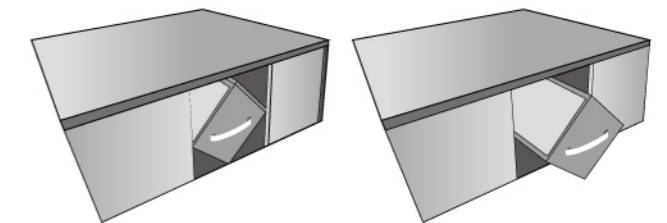

### Compact design and easy installation

With a minimum height of **306mm**, the unit is space saving, which can be installed inside limited ceiling spaces.

### Low-noise Design

Build-in low-noise ventilation fan.

## Installation example

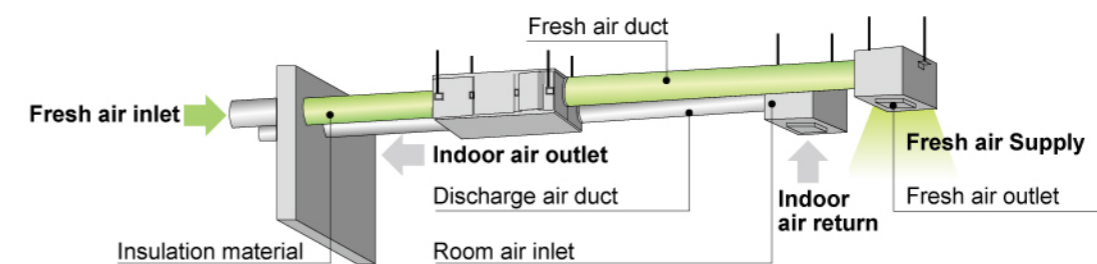

# SPECIFICATIONS

# CONNECTION BRANCHES

## ERV

MODEL			FHBQ-D3.5-K	FHBQ-D5-K	FHBQ-D8-K	FHBQ-D10-K
Power supply			220~240V~1Ph-50Hz			
Power Input	Cooling	W	165	262	400	440
Airflow rate	H/M/L	m³/h	360/260/210	500/380/300	800/600/480	1000/750/600
		CFM	212/153/124	294/224/176	471/353/282	588/441/353
Sound pressure level		dB(A)	37	39	45	46
External statics pressure	H/M/L	Pa	100/80/60	100/80/60	110/85/65	110/85/65
Temperature exchange efficiency	H/M/L	%	71/73/75	68/70/72	70/72/74	75/77/79
Enthalpy exchange efficiency	Heating (H/M/L)	%	65/67/68	62/64/65	63/65/67	66/68/70
	Cooling (H/M/L)	%	61/63/65	57/59/61	60/62/64	62/64/65
Dimension	W×D×H	mm	800X879X306	800X879X306	832X1016X380	832X1016X380
Net weight		kg	45	45	57	57

MODEL			FHBQ-D15-M	FHBQ-D20-M	FHBQ-D30-M
Power supply			380~415V 3N~50Hz		
Power Input	Cooling	W	600	950	2800
Airflow rate		m³/h	1500	2000	3000
		CFM	882	1176	1765
Sound pressure level		dB(A)	48	50	54
External statics pressure		Pa	150	150	220
Temperature exchange efficiency		%	73	71	70
Enthalpy exchange efficiency	Heating	%	65	62	62
	Cooling	%	60	58	58
Dimension	W×D×H	mm	1210X1215X452	1210X1215X452	1340X1550X572
Net weight		kg	100	100	240

## Modular Outdoor Unit Branch Joint

### Gas Pipe

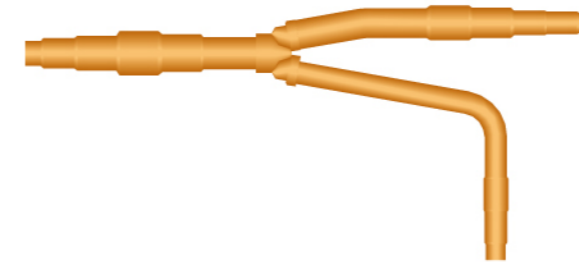

### Liquid Pipe

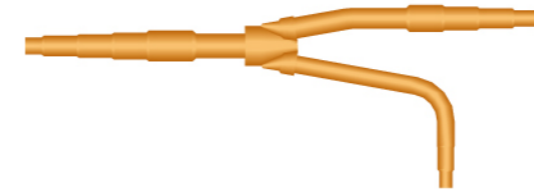

## Indoor Unit Y-Type Branch Joint

### Gas Pipe

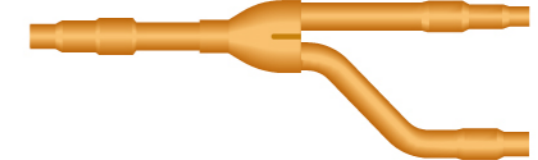

### Liquid Pipe

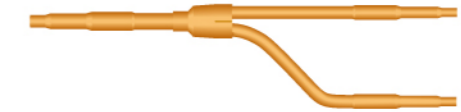

## Modular Outdoor Unit Branch Joint

Model Name	Configuration	
	Number of Outdoor Unit Modules	Number of Branch Joints
ML01/A	4	3
	3	2
	2	1

## Indoor Unit Y-Type Branch Joint

Model Name	Total cooling capacity of indoor unit (X, kW)
FQ01A/A	X ≤ 20.0
FQ01B/A	20.0 < X ≤ 30.0
FQ02/A	30.0 < X ≤ 70.0
FQ03/A	70.0 < X ≤ 135.0
FQ04/A	135.0 < X