



GMV5 HOME DC INVERTER MULTI VRF UNITS SERVICE MANUAL

T1/R410A /50-60Hz
(GC201509 - I)

CONTENTS

CHAPTER 1: PRODUCT INTRODUCTION	1
1. PRODUCT LIST	1
1.1 Outdoor unit	1
1.2 Hot water generator	1
1.3 Water tank	2
2. BASIC PARAMETER OF UNIT	2
2.1 Performance parameter of outdoor unit	2
2.2 Performance parameter of hot water generator	3
2.3 Performance parameter of water tank	4
3. PRODUCT FUNCTIONS	5
3.1 Outline of Features	5
3.2 Description of Features	5
4. BASIC OPERATIONAL PRINCIPLE	6
4.1 Flow Diagram of System	6
4.2 Instruction of flow	6
5. NAMING RULES	7
5.1 Naming rules of outdoor unit	7
5.2 Naming rules of indoor unit	7
5.3 Naming rules of hot water generator	8
5.4 Naming rules of water tank	8
6. PRODUCT MODEL SELECTION AND COLLOCATION	9
6.1 Usage mode 1: air conditioner + hot water	9
6.2 Usage mode 2: air conditioner + hot water + floor heating	10
6.3 Usage mode 3: air conditioner + floor heating	11
6.4 Requirement for connecting quantity	14
6.5 Notices for model selection	14
6.6 Product operating range	14
7. REVISION OF PRODUCT CAPACITY	14
7.1 Capacity Code	14
7.2 Capacity revision method for indoor and outdoor units	14
7.3 Revision of ambient temperature and collocation rate capacity	15
7.4 Revision coefficient of heating water capacity	29
7.5 Revision of floor heating capacity	31
7.6 Revision of length and fall difference of connecting pipe	33
7.7 Heating frosting revision factor	34
8. PRODUCT MODEL SELECTION	34
8.1 Notices for model selection	34
8.2 Overall Model Selection Steps	36
8.3 Model selection example 1: air conditioner + heating water + floor heating, air conditioner + floor heating	37
8.4 Model selection example 2: air conditioner + heating water	44
CHAPTER 2: CONTROL	45
1. UNIT CONTROL	45
1.1 General Control Method	45
1.2 Operation Flowchart	50
2. REMOTE CONTROLLER	63
3. INDOOR UNIT WIRED CONTROLLER	64
3.1 Display	64
3.2 Buttons	66
3.3 Installation and Debugging of Wired Controller	66
4. HYDRO BOX WIRED CONTROLLER	86
4.1 Display	86
4.2 Buttons	88
4.3 Installation and Debugging of Wired Controller	89
4.4 Operation Instructions	96
4.5 Malfunction Display	111

CHAPTER 3 INSTALLATION	118
1. ENGINEERING INSTALLATION FLOWCHART.....	118
2.COMMON TOOLS AND DEVICES	119
3.PREPARATION BEFORE INSTALLATION	121
3.1 Notices for Installation Engineering	121
3.2 Onsite Review of Design Drawing	123
3.3 Selection of Installation Materials	124
4 THREE OPERATION MODES.....	127
4.1 Operation mode 1: Air conditioning + water heating.....	127
4.2 Operation mode 2: Air conditioning + water heating + floor heating.....	128
4.3 Operation mode 3: Air conditioning + floor heating	129
5.INSTALLATION OF ODU.....	132
5.1 ODU Dimensions and Installation Hole Size	132
5.2 Selection of Outdoor Unit Installation Place	132
5.3 Installation Space Requirement for ODU.....	132
5.4 Installation Foundation of ODU.....	137
5.5 Vibration Reduction for ODU	138
6.INSTALLATION OF IDU.....	138
7.INSTALLATION OF HYDRO BOX.....	139
7.1 Outline dimension and installation hole dimension of hydro box.....	139
7.2 Installation Position of Hydro Box	139
7.3 Requirements for Installation Space of Hydro Box (Unit: mm)	139
7.4 Installation Procedures of Hydro Box	141
7.5 Internal Structure and Pipeline Instruction of Hydro Box.....	142
8. INSTALLATION OF WATER TANK.....	143
8.1 Outline Dimension and Installation Dimension of Water Tank.....	143
8.2 Installation Position of Water Tank.....	144
8.3 Installation Notice for Water Tank	144
9.DESIGN, INSTALLATION AND INSULATION OF REFRIGERANT PIPELINE	145
9.1 Notices for Pipeline Design.....	145
9.2 Schematic Diagram of Refrigerant Piping.....	146
9.3 Allowable Length and Height Different of Refrigerant Piping of IDU and ODU	148
9.4 Size of Refrigerant Piping	149
9.5 Installation and Insulation of Refrigerant Pipe	152
10.PIPE INSTALLATION AND INSULATION FOR THE CONDENSATE WATER SYSTEM AND INSULATION FOR THE DUCTS	160
10.1 Pipe Installation and Insulation for the Condensate Water System.....	160
10.2 Insulation for air ducts.....	164
11.INSTALLATION AND INSULATION OF HOT WATER SYSTEM PIPELINE.....	164
11.1 Connection of Hot Water System Pipeline.....	164
11.2 Connection Requirements of Hydro box and water Tank	168
11.3 Installation Requirements of Water System	168
11.4 Capacity Setting of Water Tank	168
11.5 Installation of Floor Heating Performer (floor heating water separation valve).....	171
12. ELECTRIC INSTALLATION	174
12.1 Precautions	174
12.2 Installation of Power.....	176
12.3 Wiring diagram.....	181
12.INSTALLATION OF THE COMMUNICATION SYSTEM.....	182
12.1 Connection of Communication Cable	182
12.2 Setting of Communication Address.....	184
12.3 Connection Way and Procedures of Communication Cable	185
13.REFRIGERANT CHARGING.....	191
13.1 Precautions on Refrigerant Leakage	191
13.2 Calculation of Additional Refrigerant Charge Amount	192
CHAPTER 4 COMMISSIONING OPERATION.....	194
1.COMMISSIONING FLOWCHART.....	194
2.SAFETY NOTICES	194
3.PREPARATION BEFORE COMMISSIONING	194
3.1 Preparation of Commissioning Tools	194
3.2 Preparation of Commissioning Papers	195

3.3 Inspection before Commissioning.....	197
4.COMMISSIONING OPERATION	202
4.1 Commissioning Operation of Hydro Box.....	202
4.2 Commissioning Operation of the Entire Unit	205
5. DIP SWITCH INSTRUCTIONS OF GMV5 UNIC	219
5.1 GMV5 Unic Outdoor Unit (GMV-S224W/A-X,GMV-S280W/A-X)	219
5.2 Hydro Box (NRQD16G/A-S)	241
CHAPTER 5 MAINTENANCE.....	257
1. TABLE OF ERROR CODES.....	257
2. SETTING OF OUTDOOR UNIT NOISE REDUCTION	261
2.1 Setting instruction	261
2.2 Effect of quiet mode:.....	262
3. INSTRUCTION FOR “LEAVING OUT CHARGING WATER” BETWEEN GENERATOR AND WATER TANK	263
3.1 Description of question	263
3.2 Analysis.....	263
3.3 Troubleshooting	263
4. TROUBLESHOOTING.....	265
4.1 Analysis in Forms.....	265
4.2Flowchart analysis	287
5.POWER DISTRIBUTION.....	309
5.1 Power distribution method	309
5.2 Introduction on key electric parts	309
5.3 Circuit Diagram	310
6. ASSEMBLY AND DISASSEMBLY OF PARTS	311
6.1 Introduction on key parts	311
6.2 Assembly and disassembly of key parts	314
7. COMMON MAINTENANCE.....	327
7.1 Outdoor Unit Heat Exchanger.....	327
7.2 Drain Pipe	327
7.3 Notice at the beginning of use season.....	327
7.4 Maintenance at the end of use season.....	327
7.5 Parts Replacement	327
7.6 System Leak Detection	327
7.7 System Vacuum Pumping.....	327
8.EXPLODED VIEWS AND LIST OF SPARE PARTS.....	329
8.1 Outdoor Unit.....	329
8.2 Hydro Box	332
CHAPTER 6 CARE	335
1.CARE	335
1.1 Outdoor Unit Heat Exchanger.....	335
1.2 Drain Pipe	335
1.3 Notices at the Beginning of Use Season	335
1.4 Notices at the End of Use Season.....	335
1.5 Parts Replacement	335
CHAPTER 7 MONITORING SOFTWARE	336
1 FUNCTION INTRODUCTION.....	336
2 CONNECTION OF COMPUTER AND UNITS.....	336
3 HARDWARE INTRODUCTION.....	337
3.1 List of parts	337
3.2 Gree USB Data Converter	337
3.3 Communication Board	339
3.4 Communication Wire.....	339
4 SOFTWARE INTRODUCTION	340
4.1 Installation Requirements	340
4.2 Installation Flowchart	342
4.3 Installation Procedure	342
5. USE OF SOFTWARE	359
5.1 Introduction of Functions	359
5.2 Operation Methods	359
6. DEBUGGING OF SOFTWARE.....	383

6.1 Flowchart of Debugging	383
6.2 Troubleshooting	384

SAFETY PRECAUTIONS

Meaning of precautions and symbols

Precautions in this manual are classified according to their seriousness and possibility.



Danger

It means danger. If it is unavoidable, death or serious personal injury will occur.



Warning

It means potential danger. If it is unavoidable, death or serious personal injury may occur.



Caution

It means potential danger. If it is unavoidable, light or medium injury may occur. It is also used to warn against dangerous behavior.



Notice

It means equipment or property loss may occur.



Information

It is used to point out useful or extra information.



Transferring

It is used to transfer to a designated part.

PREFACE



Thank you for choosing Gree GMV5 Home Units.

For correct installation, operation and maintenance and for reaching the expected performance, please read this manual carefully. This manual is applicable to GMV5 Home Units. Professional operators must follow relevant national (local) safety requirements and technical specifications set forth in this manual during operation; otherwise, the air conditioning system may fail or be damaged, and personnel safety accident may also occur.

CHAPTER 1: Product introduction

1. Product List



1.1 Outdoor unit

Model	Product code	Cooling capacity kW	Heating capacity kW	Power source	Refrigerant	Outside view
GMV-S120WL/A-S	CN853W0110	12.1	14.0	220-240V~ 50Hz/60HZ	R410a	
GMV-S140WL/A-S	CN853W0120	14.0	16.5			
GMV-S160WL/A-S	CN853W0130	16.0	18.5			
GMV-S224W/A-X	CN853W0140	22.4	25	380~415V 3N~ 50Hz/60HZ	R410a	
GMV-S280W/A-X	CN853W0150	28	31.5			

1.2 Hot water generator

Model	Product code	Capacity range (kW)	Outside view
NRQD16G/A-S	CN700N0010	3.6~16	

1.3 Water tank

Model	Product code	Capacity of water tank (L)	Outside view
SXVD200LCJ/A-K	ER20000160	200	
SXVD300LCJ/A-K	ER20000180	300	
SXVD350LCJ/A-K	ER20000230	350	
SXVD400LCJ/A-K	ER20000220	400	
SXVD200LCJ2/A-K	ER20000170	200	
SXVD300LCJ2/A-K	ER20000190	300	
SXVD350LCJ2/A-K	ER20000200	350	
SXVD400LCJ2/A-K	ER20000210	400	

Notes:

- (1) For specific provided capacity of water tank, please refer to the local climate conditions and suggestion of professional person.
- (2) If specification is changed due to improvement of product, please subject to specific name plate of product.

2. Basic Parameter of Unit

2.1 Performance parameter of outdoor unit

Model		GMV-S120 WL/A-S	GMV-S140WL/A-S	GMV-S160WL/A-S	GMV-S224W/A-X	GMV-S280W/A-X	
Cooling capacity	kW	12.10	14.00	16.00	22.4	28	
Heating capacity	kW	14.00	16.50	18.50	25	31.5	
Noise	dB(A)	55	56	58	57	58	
Water supply temperature	°C	50 (default), adjustable within 35~55°C					
Power source		220-240V~50Hz/60HZ	220-240V~50Hz/60HZ	220-240V~50Hz/60HZ	380V-415V 3N ~ 50Hz/60Hz	380V-415V 3N ~ 50Hz/60Hz	
Air volume	m ³ /h	6000	6300	6600	14000	14000	
External static pressure	Pa	0	0	0	80	80	
Rated power	Cooling	kW	3.05	3.98	4.85	5.35	7.7
	Heating	kW	3.3	4.10	4.67	5.8	7.6
	Heating water	kW	3.3	3.8	4.2	5.0	5.2
Quantity of compressor	set	1	1	1	1	1	
Waterproof level		IPX4	IPX4	IPX4	IPX4	IPX4	
Connecting pipe	Liquid pipe	mm	Φ9.52	Φ9.52	Φ9.52	Φ9.52	Φ9.52
	Air pipe	mm	Φ15.9	Φ15.9	Φ19.05	Φ19.05	Φ22.2
	High pressure air	mm	Φ12.7	Φ12.7	Φ12.7	Φ15.9	Φ15.9

GMV5 Home DC Inverter Multi VRF Units

	pipe						
	Connecting way		Connect with horn mouth	Connect with horn mouth	Connect with horn mouth	Welding connection	Welding connection
Net weight	kg	113	113	113	295	295	
Minimum circuit current	A	27.0	31.0	33.0	16.1	20.9	
Maximum fuse current	A	32.0	32.0	40.0	20.0	25.0	
External dimension (WxDxH)	mm	900×340×1345	900×340×1345	900×340×1345	1340×765×1605	1340×765×1605	

- 1) Test voltage of GMV-S120WL/A-S, GMV-S140WL/A-S, GMV-S160WL/A-S is 220V~50HZ; test voltage of GMV-S224W/A-X, GMV-S280W/A-X is 380-415V 3N~50/60HZ.
- 2) Test working conditions of the above nominal cooling capacity is: indoor dry bulb/wet bulb temperature (27°C /19°C), outdoor dry bulb/wet bulb temperature (35°C /24°C); Test working conditions of the above nominal heating capacity is: indoor dry bulb/wet bulb temperature (20°C /15°C), outdoor dry bulb/wet bulb temperature (7°C /6°C); Test working conditions of the above nominal water heating capacity is: initial water temperature/terminal water temperature (15°C /52°C), outdoor dry bulb/wet bulb temperature (20°C /15°C).
- 3) Performance parameter of unit will be changed due to improvement of product, there will be no further notification. For specific parameter please subject to name plate of product.
- 4) Heating water power is the average power for collocating with nominal working condition of hot water generator NRQD16G/A-S.
- 5) The noise is measured in laboratory, the noise in actual operation will be slightly high due to change of environment.
- 6) Sectional area of lead is only applicable to the longest distance range of 15 meters, if it is over 15 meters, sectional area of lead should be accordingly increased to avoid overload of current and burning of lead.
- 7) Select air switch according to maximum fuse current, and select electric wire according to minimum circuit current.

2.2 Performance parameter of hot water generator

Model		NRQD16G/A-S	
Hot water heating capacity	kW	4.5(3.6-16)	
Hot water yielding volume	L/h	105(75-140)	
Floor heating capacity	kW	16	
Consumed power for electric heating	kW	3	
Power source	-	220-240V ~ 50/60Hz	
Water pump	Input power	kW	0.08-0.14
	Water flow	m ³ /h	1.7
	Delivery lift (available for external pipeline network)	m	6

GMV5 Home DC Inverter Multi VRF Units

Type of heat exchanger		-	Plate heat exchanger
Connection of water system	Pipe diameter of water inlet/outlet pipe	mm	Φ25
	Specification of screw thread	-	G1
Connection of refrigerant system	Air pipe	mm	Φ15.9
	Liquid pipe	mm	Φ9.52
	High pressure air pipe	mm	Φ12.7
External dimension (W×D×H)		mm	500×919×328
Net weight		kg	56

2.3 Performance parameter of water tank

Model		SXVD200LCJ/A-K	SXVD300LCJ/A-K	SXVD350LCJ/A-K	SXVD400LCJ/A-K
Capacity	L	200	300	350	400
Consumed power for electric heating	kW	3.0	3.0	3.0	3.0
Highest working pressure	MPa	0.7	0.7	0.7	0.7
Inner pot	Material	-	SUS304L	SUS304L	SUS304L
	Thickness	mm	1.5	1.5	1.5
Insulating layer	Material	-	Polyurethane	Polyurethane	Polyurethane
	Thickness	mm	50	45	45
External layer	Material	-	Cold plate	Cold plate	Cold plate
	Thickness	mm	0.8	0.8	0.8
Circulating water pipe	Pipe diameter	mm	DN20	DN20	DN20
	Specification of screw thread	-	G3/4	G3/4	G3/4
Cooling water inlet pipe	Pipe diameter	mm	DN15	DN15	DN15
	Specification of screw thread	-	G1/2	G1/2	G1/2
Hot water outlet pipe	Pipe diameter	mm	DN15	DN15	DN15
	Specification of screw thread	-	G1/2	G1/2	G1/2
External dimension	External diameter×height	mm	Φ540×1595	Φ620×1620	Φ620×1895
Net weight of unit		kg	68	82	96

Model		SXVD200LCJ2/A-K	SXVD300LCJ2/A-K	SXVD350LCJ2/A-K	SXVD400LCJ2/A-K
Capacity	L	200	300	350	400
Consumed power for electric heating	kW	3.0	3.0	3.0	3.0
Highest working pressure	MPa	0.7	0.7	0.7	0.7
Inner pot	material	-	SUS304L	SUS304L	SUS304L
	thickness	mm	1.5	1.5	1.5
Insulating layer	material	-	Polyurethane	Polyurethane	Polyurethane
	thickness	mm	50	45	45

GMV5 Home DC Inverter Multi VRF Units

External layer	material	-	Cold plate	Cold plate	Cold plate	Cold plate
	thickness	mm	0.8	0.8	0.8	0.8
Circulating water pipe	Pipe diameter	mm	DN20	DN20	DN20	DN20
	Specification of screw thread	-	G3/4	G3/4	G3/4	G3/4
Cooling water inlet pipe	Pipe diameter	mm	DN15	DN15	DN15	DN15
	Specification of screw thread	-	G1/2	G1/2	G1/2	G1/2
Hot water outlet pipe	Pipe diameter	mm	DN15	DN15	DN15	DN15
	Specification of screw thread	-	G1/2	G1/2	G1/2	G1/2
External dimension	External diameter×height	mm	Φ540×1595	Φ620×1620	Φ620×1895	Φ620×2125
Net weight of unit		kg	71	87	100	110

Notes:

Performance parameter of product will be changed due to improvement of product, there will be no further notification. For specific parameter please subject to name plate of product.

3. Product Functions

3.1 Outline of Features

GMV5 Home is Gree's latest self-developed air conditioning unit integrated with "central air conditioner + hot water + floor heating". GMV5 Home is an integrated system that a set of air-cooled outdoor unit connecting to several direct evaporative indoor units with the same or different forms or capacities, and at the same time connecting to one or more hot water generators, which can provide one or more different areas with processed air and hot water. It is mainly applicable for residential use or small commercial locations.

The unit adopts the first-innovated CAN network multi-connection communication technology that its communication response speed is faster and more reliable; it can completely achieve auto addressing function and non-polar freely wire connection. The unit adopts advanced DC inverter technology and PID real-time control technology, which can achieve more powerful performance, higher energy efficiency ratio and more reliable operation.

3.2 Description of Features

High-efficiency and energy-saving

It adopts self-developed DC inverter technology for intelligently and integrately driving the system. Under full heat recovery mode of "cooling + heating water", its ECOP can be up to 7.0; it adopts DC inverter water pump that has good performance in energy consumption, flow-delivery lift adjustment range and performance curve.

Auto quiet mode

The unit has night-time quiet mode and compulsory quiet mode with the lowest operating noise of 45dB (A).

Unique and comfortable function

The unit has cooling auto heat recovery function that can automatically recover the heat to heat water, which is energy-saving and high-efficiency; water heating and floor heating function can be simultaneously turned on with 3D heating, which is comfortable; optimized defrosting function can reduce fluctuation of indoor temperature.

Wired controller of indoor unit can control floor heating

The generator has interface of floor heating performer, it can connect to floor heating performer; wired controller of indoor unit can control on/off of floor heating performer of the room, user needs not to purchase floor heating temperature controller separately;

Other features

The unit has auto addressing distribution function and non-polar communication function; unit has auto debugging and malfunction detection function; the unit adopts first-created CAN network multi-unit communication technology, which is more reliable and has faster response speed;

4. Basic Operational Principle

4.1 Flow Diagram of System

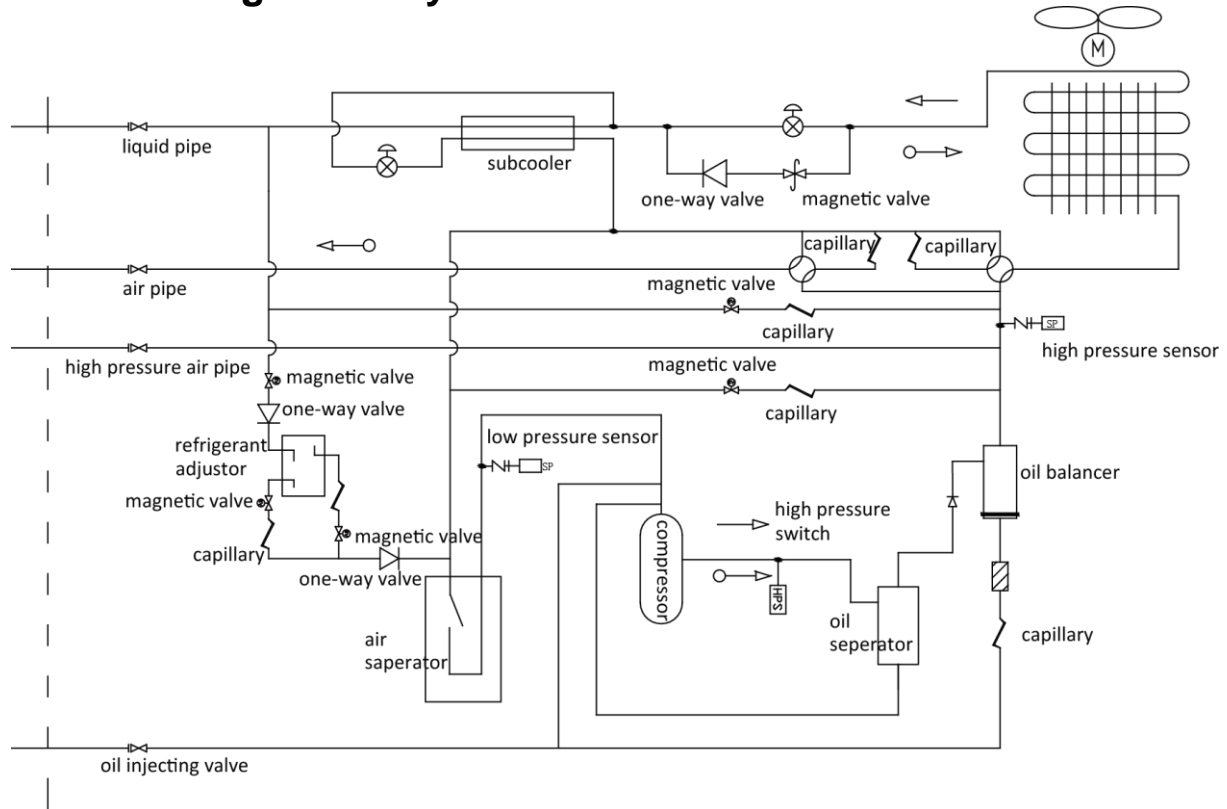

4.2 Instruction of flow

Energize the unit, after the indoor and outdoor unit start to run and conduct cooling, the low-temperature and low-pressure refrigerant gas comes from heat exchangers of different indoor units is converged and compressed into compressor to be high-temperature and high-pressure gas, and then it discharges into heat exchanger of outdoor unit and conducts heat exchange with outdoor air to be refrigerant liquid, the refrigerant liquid will flow to each indoor unit via Y shape branch pipes or branch manifolds, and is decompressed and cooled down by throttling device, finally enters into heat exchanger of indoor unit and conducts heat exchange with adjustable air to be low-temperature and low-pressure refrigerant gas. Circulate repeatedly in this way so as to achieve cooling.

When conduct heating, four-way valve A and four-way valve B will operate to make refrigerant conduct circulation according to converse process of cooling process; refrigerant discharges heat in heat exchanger of indoor unit (electric heating components will also operate and discharge heat under certain conditions), and absorbs heat from heat exchanger of outdoor unit to conduct heat pump heating circulation, so as to achieve heating.

When conduct heating and water heating, four-way valve A and and four-way valve B operate, refrigerant discharges heat in heat exchanger of indoor unit and hot water generator, and absorbs heat from heat exchanger of outdoor unit to conduct heat pump heating and water heating circulation, so as to achieve heating and heating water.

When heating water, four-way valve B operates, four-way valve B operates, refrigerant discharges heat in hot water generator, and absorbs heat in heat exchanger of outdoor unit and conduct heat pump heating and water heating circulation, so as to achieve heating water.

When conduct cooling and heating water, four-way valve B will operate according to actual situation, refrigerant will discharge heat in hot water generator, and absorb heat in heat exchanger

of indoor unit and conduct cooling and heating water circulation, under this mode it can achieve full heat recovery. But when water temperature is high, it can only achieve partial heat recovery. System can identify according to reliable operating range. So as to achieve cooling and heating water.

When conduct floor heating, four-way valve B operates, refrigerant will discharge heat in hot water generator, and absorb heat to conduct heat pump heating and heating water circulation, so as to achieve floor heating.

5. Naming Rules

5.1 Naming rules of outdoor unit

GMV	□	—	□	□	□	W	□	/	□	□	—	□
1	2		3	4	5	6	7		8	9		10

No.	Description	Optional Items
1	Model	GMV-Gree multi VRF air conditioner
2	Type of climate	Omitted-T1 work condition; T2-T2 low temperature work condition; T3-T3 high temperature work condition
3	Model	DC inverter (omitted)
4	Functional code	Q—heat recovery unit; S—water heater; W—water-cooled chiller; X—fresh air processing unit; omitted—no the above functions
5	Code of refrigerant capacity	Nominal cooling refrigerant/100(W)
6	Code of outdoor unit	W—outdoor unit
7	Classification of struction	M—modulerized (top discharge); L—non-modulerized side discharge; omitted —non-nodulerized top discharge
8	Type of refrigerant	Omitted: R410A
9	Design No.	Named as A, B, C..., and then extended with number 1, 2, 3...
10	Form of power source	X—380~415V-3Ph-50/60Hz; S—220-240V~,50Hz/60Hz; T—applicable to 208-230V~, 60Hz, and 220-240V~, 50Hz;

5.2 Naming rules of indoor unit

GMV	—	N	□	□	□	□	□	/	□	—	□
1		2	3	4	5	6	7		8		9

No.	Description	Optional Items
1	Model	GMV-Gree multi VRF air conditioner
2	Code of indoor unit	N
3	Form of motor	D-DC motor; omitted-AC motor
4	Functional code	R-heat pump only; L-cooling only; X-fresh air; W-double heat source; Q-heat recovery; omitted-defaulted electric heating
5	Code of cooling capacity	Nominal cooling capacity/100(W)
6	Classification of unit	PL-low static pressure duct type unit; P-standard static pressure duct type unit; PH-high static pressure duct type unit; PB-thin duct type unit; T-four-side cassette type unit; TD-single-side cassette type unit; TS-double-side cassette type unit; C-console type unit; ZD-floor ceiling type unit; G-wall-mounted unit

GMV5 Home DC Inverter Multi VRF Units

7	With water pump or not	With water pump-S (cassette type unit is acquiescent to be with water pump without representing S)
8	Design No.	Named as A, B, C..., and then extended with number 1, 2, 3...
9	Form of power source	T—applicable to 208-230V~, 60Hz, and 220-240V~, 50Hz; K—220-240V~,50Hz;

5.3 Naming rules of hot water generator

N	RQ	D	16	G	/	A	—	□
1	2	3	4	5		6		7

No.	Description	Optional Items
1	Developmental sequence	N—newly developed
2	Product code	RQ—hot water generator
3	Functional features	D—with electric heating function; omitted—no electric heating function
4	Rated capacity	Rated power of generator (kW)
5	Code of structure	G—wall-mounted; L--vertical; W--horizontal
6	Design No.	Arrange in A, B, C... order
7	Form of power source	S—220-240V~,50Hz/60Hz; T—applicable to 208-230V~, 60Hz, and 220-240V~, 50Hz;

5.4 Naming rules of water tank

SX	□	□	□	□	□	□	□	□	/	□	—	□
1	2	3	4	5	6	7	8	9		10		11

No.	Description	Optional Items
1	Model	SX-water tank
2	Type of water tank	V—heat pump water tank for multi VRF unit; common heat pump water tank--obmitted
3	Functional code	Obmitted—no electric heating; D—with electric heating function;
4	Capacity of water tank	Unit: L
5	Form of structure	B—wall-mounted; L—floor standing
6	With bearing pressure or not	C—with bearing pressure; omitted—no beraing pressure
7	Form of coil	Omitted—no heat exchange tube; J—static heating mode of built-in coil (J represents single coil, J2 represents double coils); JW—static heating mode of external winding coil; D—coil with floor heating (D represents single coil, D2 represents double coils)
8	Structure of appearance	Omitted—round; F—square; T—rectangle ; Y—abnormity
9	Quantity of inner pot	Omitted—one; 2--two
10	Design No.	Arrange in A, B, C... order
11	Form of power source	K—220-240V~,50Hz;

6. Product model selection and collocation

6.1 Usage mode 1: air conditioner + hot water

Model of outdoor unit		Indoor unit	Hot water generator	Water tank
Side discharge	GMV-S120WL/A-S GMV-S140WL/A-S GMV-S160WL/A-S	Related indoor unit of GMV5	NRQD16G/A-S	(1) Inner-coil water tank SXVD200LCJ/A-K SXVD300LCJ/A-K SXVD350LCJ/A-K SXVD400LCJ/A-K
Top discharge	GMV-S224W/A-X GMV-S280W/A-X			(2) Inner-coil water tank can connect to solar energy function SXVD200LCJ2/A-K SXVD300LCJ2/A-K SXVD350LCJ2/A-K SXVD400LCJ2/A-K

Installation methods are as below:

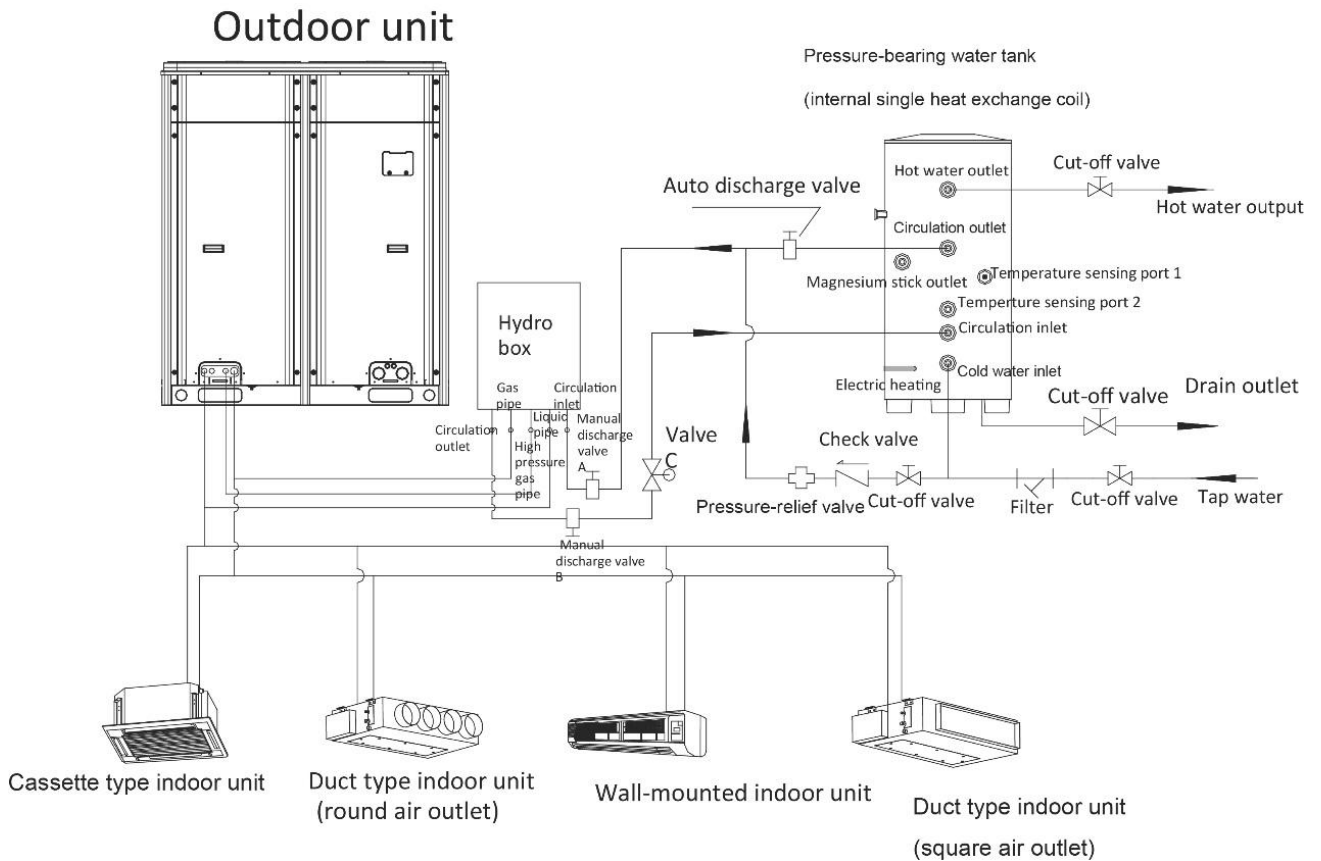

GMV5 Home DC Inverter Multi VRF Units

If it needs to connect to solar energy function, installation methods are as below:

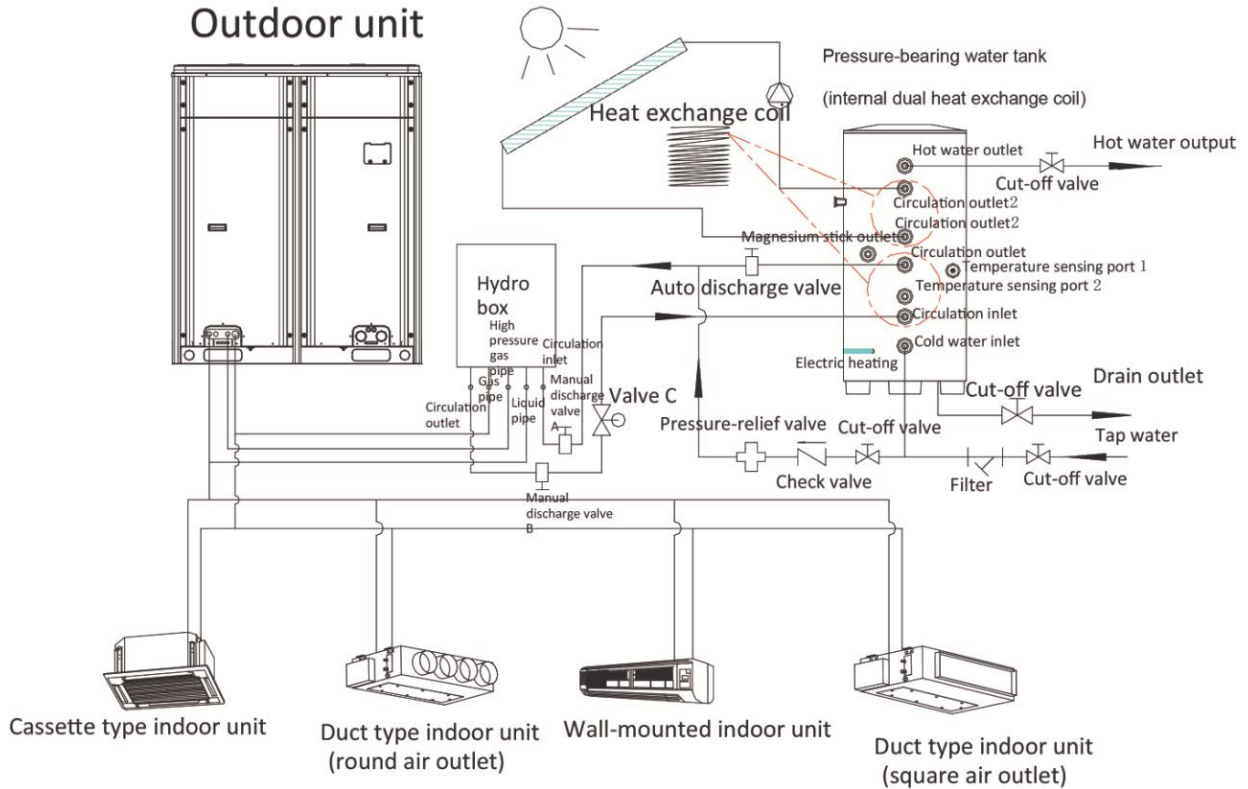

6.2 Usage mode 2: air conditioner + hot water + floor heating

Model of outdoor unit		Indoor unit	Hot water generator	Water tank
Side discharge	GMV-S120WL/A-S GMV-S140WL/A-S GMV-S160WL/A-S	Related indoor unit of GMV5	NRQD16G/A-S	(1) Inner-coil water tank SXVD200LCJ/A-K SXVD300LCJ/A-K SXVD350LCJ/A-K SXVD400LCJ/A-K
Top discharge	GMV-S224W/A-X GMV-S280W/A-X			(2) Inner-coil water tank can connect to solar energy function: SXVD200LCJ2/A-K SXVD300LCJ2/A-K SXVD350LCJ2/A-K SXVD400LCJ2/A-K

Notes: C valve and D valve should be straight-through magnetic water valve with small resistance

Installation methods are as below:

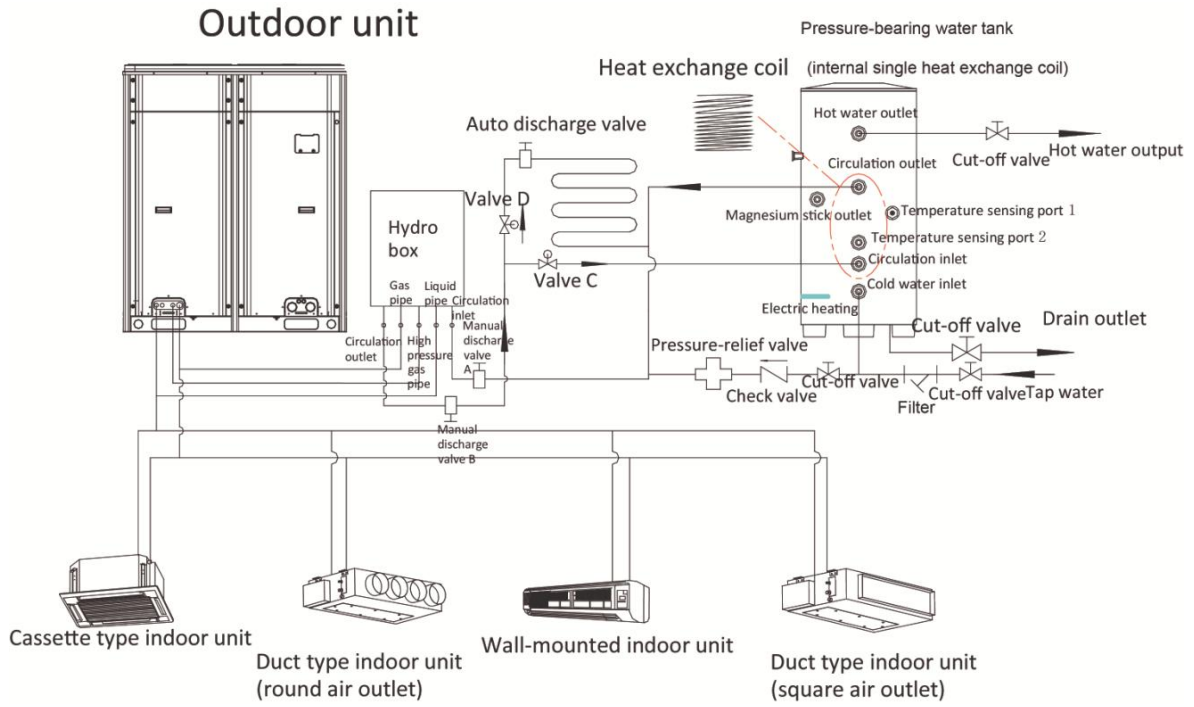

If it needs to connect to solar energy function, then connecting methods are as below:

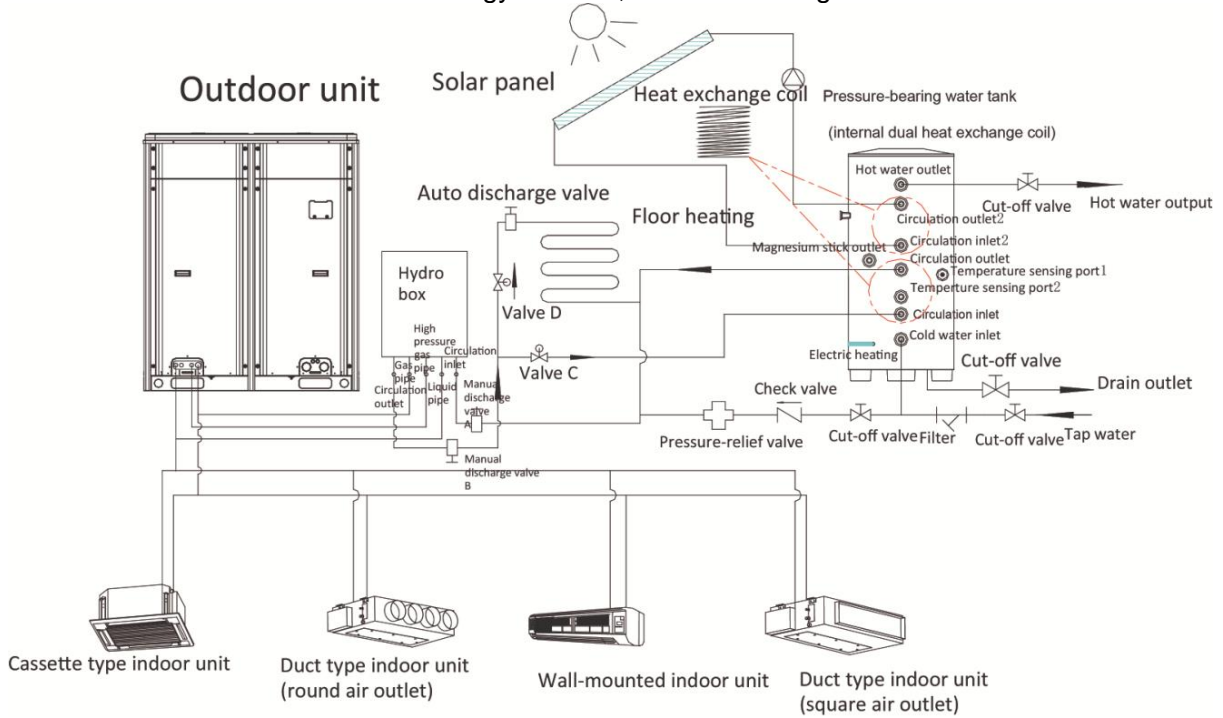

6.3 Usage mode 3: air conditioner + floor heating

Usage mode 3: air conditioner + floor heating			
Model of outdoor unit		Indoor unit	Hot water generator
Side discharge	GMV-S120WL/A-S GMV-S140WL/A-S GMV-S160WL/A-S	Related indoor unit of GMV5	NRQD16G/A-S
Top discharge	GMV-S224W/A-X GMV-S280W/A-X		

Installation methods are as below:

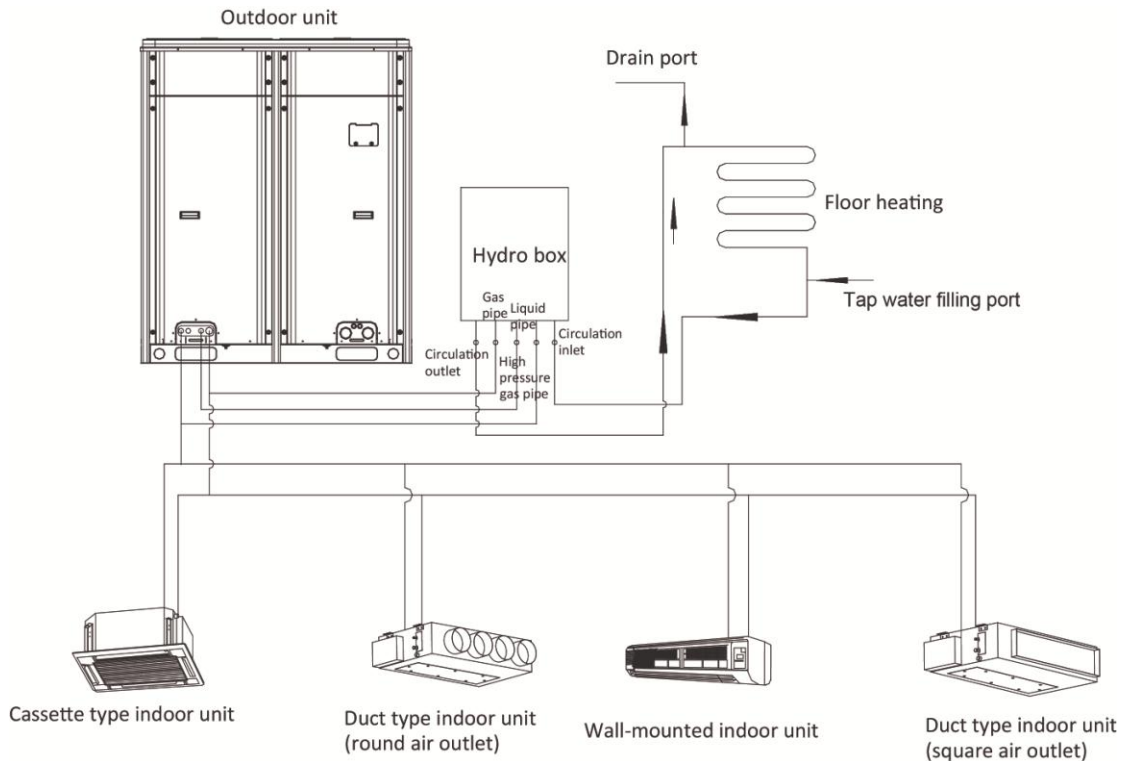

 Notes:

- 1) Before installation and debugging, please read these prompts carefully!
- 2) This hot water generator is only used for closed type water system, open type system such as no-coil water tank should not use this hot water generator; it should be installed indoors with ambient temperature of $4^{\circ}\text{C} \sim 35^{\circ}\text{C}$. It is not allowed to install outdoors, otherwise it may cause malfunction.
- 3) If the unit will not be operated for long or the unit is de-energized, please drain the pipelines of generator, water tank and floor heating, otherwise the equipment will be frozen; during installation, please add draw off valve in water inlet and outlet of hot water generation to avoid inadequate drainage and freezing of system.
- 4) Before energizing the unit, please check if “S2” dial code in mainboard is consistent with actual situation of connecting equipment, otherwise it may impact reliability of unit and will give out temperature sensor malfunction.
- 5) If water pressure for water replenishing is larger than 3bar, please install reducing valve in water replenishing inlet of equipment to ensure water pressure of system is $\leq 3\text{bar}$, otherwise atmospheric valve and other valves will open and lead to water leakage;
- 6) Connect to floor heating equipment, if crushing of water system other than hot water generator is larger than 6m, please install engineering water pump.
- 7) Wired controller of air conditioner can control floor heating, for specific setting and operation please carefully read the instruction manual of hot water generator and instruction manual of wired controller.

- 8) When connecting hot water generator with water tank, circulation water outlet of hot water generator should connect to circulation water inlet of hot water generator, and circulation water inlet of water tank should connect to circulation water outlet of water tank, for specific installation please refer to instruction manual of hot water generator.
- 9) If hot water generator needs to connect to floor heating system or water tank, please install water system magnetic valve C and magnetic valve D according to instructional sketch map of unit, and control heating of water tank and water system of floor respectively. C valve and D valve should be straight-through magnetic water valve with small resistance (generator NRQD16G/A-S has been provided with C valve and D valve), and floor heating performer of C valve and D valve should be closed type.
- 10) When the system is connected to floor heating function, the water system and water tank are different water systems, thus it should set tap water inlet and drain interface.
- 11) User can install back water pump to keep water temperature of water pipe.
- 12) Water pipeline should be installed after fixing hot water generator. During the course of installing connecting pipe, please prevent dust or other foreign matters from entering into pipeline system.
- 13) After connecting all the water pipelines, conduct leakage detection first, and then conduct heat insulation for the whole water system, especially for the joints such as valves and pipe junctions. It is suggested to use heat insulating cotton with thickness not less than 15mm.
- 14) Heat insulation bearing pressure water tank provides hot water by depending on pressure of tap water, only under the condition of with tap water can produce hot water. When using the unit, please keep the cut-off valve of cooling water inlet of water tank is open.
- 15) Cooling and floor heating functions cannot be turned on simultaneously. If floor heating function cannot be turned on and the unit displays “mode limitation”, please switch mode of indoor unit to be heating or heating closedown mode.
- 16) Horizontal distance between hot water generator and insulating water tank should not be over 5 meters, and vertical height difference should not be over 3 meters. If it is over the above value, please contact our company. It is suggested to install insulating water tank in lower position and hot water generator in upper position.
- 17) Prepare material according to the above size and specification of joint. If cut-off valve is installed outdoors, it is suggested to use PPR pipe fittings to avoid freezing of pipeline under low temperature.

6.4 Requirement for connecting quantity

Model	Limit for rated capacity of indoor unit accounting for rated capacity of outdoor unit	Limit for quantity of generator
GMV-S120WL/A-S	80% ~ 100%	1
GMV-S140WL/A-S	80% ~ 100%	1
GMV-S160WL/A-S	80% ~ 100%	1
GMV-S224W/A-X	80% ~ 100%	2
GMV-S280W/A-X	80% ~ 100%	2

Notes:

One hot water generator can connect to one inner-coil water tank at most (model: SXVD***LCJ*/A-K).

6.5 Notices for model selection

- 1) This unit must be connected to indoor unit of air conditioner, otherwise the unit cannot be operated; and rated capacity of indoor unit of air conditioner accounts for 80%~100% of rated capacity of outdoor unit;
- 2) Installation for floor heating: space between floor heating tubes is better to be within 100~150mm, and pipe diameter should be as large as possible within the selectable range (it is recommended to select over DN20). Otherwise the oversize of clearance and undersize of pipe diameter will cause increasing of heating load and water resistance, and will reduce heat exchange efficiency and increase energy consumption;

6.6 Product operating range

Cooling operating range	Outdoor temperature is -5℃~50℃
Heating operating range	Outdoor temperature is -15℃~24℃
Cooling+heating water operating range	Outdoor temperature is -5℃~43℃
Heating+heating water operating range	Outdoor temperature is -15℃~24℃
Heating water operating range	Outdoor temperature is -15℃~43℃
Floor heating operating range	Outdoor temperature is -15℃~21℃

7. Revision of Product Capacity

7.1 Capacity Code

Capacity code of indoor unit=numerical value for rated cooling capacity of indoor unit (take W as unit) ×0.01

Capacity code of outdoor unit=numerical value for rated cooling capacity of outdoor unit (take W as unit) ×0.01

7.2 Capacity revision method for indoor and outdoor units

Actual capacity of each indoor unit=actual capacity of outdoor unit×capacity of indoor unit/maximum capacity of simultaneous operated indoor units

Actual capacity of outdoor unit=capacity of outdoor unit after revision according to collocation rate of indoor and outdoor unit and indoor and outdoor temperature×revision coefficient of pipe distance and height difference between indoor and outdoor units×revision factor for heating and frosting

Notes:

- 1) Capacity of outdoor unit after revision according to collocation rate of indoor and outdoor unit 、 temperature of inside and outside –look up capacity revision table.
- 2) revision factor for heating and frosting—revision factor when select models according heat load .

7.3 Revision of ambient temperature and collocation rate capacity

7.3.1 Revision of cooling capacity

GMV-S120WL/A-S

TC—represents capacity of outdoor unit; PI—represents power of outdoor unit															
Operating capacity (%)	Outdoor ambient temperature (°CDB)	Indoor ambient temperature (°C)													
		14.0°C WB		16.0°C WB		18.0°C WB		19.0°C WB		20.0°C WB		22.0°C WB		24.0°C WB	
		20.0°C DB		23.0°C DB		26.0°C DB		27.0°C DB		28.0°C DB		30.0°C DB		32.0°C DB	
		TC	PI	TC	PI	TC	PI	TC	PI	TC	PI	TC	PI	TC	PI
		kW	kW	kW	kW	kW	kW	kW	kW	kW	kW	kW	kW	kW	kW
100%	10	7.7	1.02	9.1	1.24	10.7	1.48	11.3	1.60	12.0	1.69	13.6	1.95	14.4	1.62
	12	7.7	1.04	9.1	1.26	10.7	1.50	11.3	1.62	12.0	1.75	13.6	2.00	14.1	1.64
	14	7.7	1.05	9.1	1.28	10.7	1.54	11.3	1.65	12.0	1.81	13.6	2.04	14.0	1.67
	15	7.7	1.07	9.1	1.31	10.7	1.56	11.3	1.67	12.0	1.87	13.5	2.11	13.8	1.68
	18	7.7	1.10	9.1	1.33	10.7	1.60	11.3	1.71	12.0	1.97	13.3	2.19	13.6	1.73
	20	7.7	1.13	9.1	1.37	10.7	1.65	11.3	1.81	12.0	2.06	13.1	2.25	13.3	1.82
	21	7.7	1.15	9.1	1.39	10.7	1.68	11.3	1.86	12.0	2.13	13.0	2.31	13.3	1.87
	23	7.7	1.18	9.1	1.44	10.7	1.81	11.3	1.95	12.0	2.18	12.9	2.40	13.0	1.97
	25	7.7	1.22	9.1	1.56	10.7	1.93	11.3	2.07	12.0	2.31	12.7	2.46	12.9	2.09
	27	7.7	1.31	9.1	1.62	10.7	2.03	11.3	2.28	12.0	2.43	12.5	2.58	12.8	2.31
	29	7.7	1.37	9.1	1.81	10.7	2.20	11.3	2.45	11.9	2.57	12.3	2.70	12.6	2.47
	31	7.7	1.50	9.1	1.88	10.7	2.33	11.3	2.62	11.8	2.71	12.1	2.76	12.4	2.64
	33	7.7	1.61	9.1	2.03	10.7	2.51	11.3	2.81	11.6	2.73	11.9	2.89	12.2	2.83
	35	7.7	1.68	9.1	2.15	10.7	2.69	11.3	3.02	11.4	3.03	11.7	3.04	12.1	3.05
	37	7.7	1.77	9.1	2.31	10.7	2.87	11.1	3.13	11.3	3.09	11.6	3.14	11.9	3.15
	39	7.7	1.86	9.1	2.45	10.7	3.05	11.0	3.18	11.1	3.18	11.3	3.25	11.6	3.21
	41	7.7	1.94	9.1	2.51	10.7	3.11	11.0	3.23	11.1	3.26	11.3	3.31	11.5	3.27
	43	7.7	2.01	9.1	2.54	10.7	3.18	11.0	3.29	11.0	3.34	11.2	3.37	11.4	3.33
45	7.7	2.06	9.1	2.59	10.5	3.24	10.8	3.35	10.9	3.36	11.2	3.49	11.3	3.39	
47	7.7	2.11	9.1	2.73	10.5	3.30	10.5	3.41	10.7	3.48	11.1	3.56	11.2	3.45	
48	7.7	2.19	9.1	2.76	10.3	3.37	10.5	3.47	10.6	3.60	11.0	3.65	11.1	3.52	
90%	10	6.9	0.86	8.2	1.04	9.5	1.24	10.2	1.35	10.9	1.43	12.2	1.64	13.5	1.36
	12	6.9	0.87	8.2	1.06	9.5	1.26	10.2	1.37	10.9	1.48	12.2	1.68	13.4	1.38
	14	6.9	0.89	8.2	1.07	9.5	1.29	10.2	1.38	10.9	1.53	12.2	1.71	13.4	1.40
	15	6.9	0.90	8.2	1.10	9.5	1.31	10.2	1.40	10.9	1.58	12.2	1.77	13.4	1.42
	18	6.9	0.92	8.2	1.11	9.5	1.35	10.2	1.43	10.9	1.65	12.2	1.85	1.3	1.45
	20	6.9	0.95	8.2	1.15	9.5	1.38	10.2	1.51	10.9	1.73	12.2	1.89	13.1	1.53
	21	6.9	0.97	8.2	1.17	9.5	1.68	10.2	1.56	10.9	1.80	12.2	1.94	13.0	1.57
	23	6.9	0.98	8.2	1.21	9.5	1.51	10.2	1.64	10.9	1.83	12.2	2.01	12.8	1.66
	25	6.9	1.02	8.2	1.31	9.5	1.62	10.2	1.75	10.9	1.94	12.2	2.06	12.6	1.76
	27	6.9	1.10	8.2	1.37	9.5	1.70	10.2	1.92	10.9	2.04	12.2	2.17	12.5	1.94
	29	6.9	1.15	8.2	1.52	9.5	1.85	10.2	2.06	10.9	2.16	12.1	2.27	12.3	2.07

GMV5 Home DC Inverter Multi VRF Units

	31	6.9	1.26	8.2	1.58	9.5	1.96	10.2	2.19	10.9	2.28	11.9	2.32	12.1	2.22
	33	6.9	1.35	8.2	1.70	9.5	2.11	10.2	2.36	10.9	2.29	11.6	2.43	11.9	2.38
	35	6.9	1.42	8.2	1.81	9.5	2.26	10.2	2.54	10.9	2.55	11.4	2.55	11.7	2.57
	37	6.9	1.49	8.2	1.94	9.5	2.41	10.2	2.63	10.9	2.59	11.2	2.64	11.5	2.65
	39	6.9	1.56	8.2	2.06	9.5	2.56	10.2	2.67	10.9	2.67	11.1	2.73	11.3	2.70
	41	6.9	1.63	8.2	2.11	9.5	2.62	10.2	2.72	10.8	2.74	11.0	2.78	11.2	2.75
	43	6.9	1.68	8.2	2.13	9.5	2.67	10.1	2.76	10.7	2.80	10.8	2.83	11.1	2.80
	45	6.9	1.73	8.2	2.18	9.5	2.72	9.9	2.82	10.6	2.83	10.7	2.94	11.0	2.85
	47	6.9	1.77	8.2	2.29	9.5	2.77	9.8	2.87	10.4	2.93	10.6	2.99	10.9	2.90
	48	6.9	1.83	8.2	2.32	9.5	2.83	9.7	2.92	10.2	3.03	10.4	3.07	10.7	2.95
80%	10	6.1	0.72	7.3	0.88	8.5	1.05	9.1	1.13	9.6	1.20	10.9	1.39	12.1	1.15
	12	6.0	0.74	7.3	0.90	8.5	1.07	9.1	1.16	9.6	1.24	10.9	1.42	12.0	1.17
	14	6.0	0.75	7.3	0.91	8.5	1.09	9.1	1.17	9.6	1.29	10.9	1.44	12.0	1.18
	15	6.0	0.76	7.3	0.93	8.5	1.11	9.1	1.18	9.6	1.33	10.9	1.50	12.0	1.20
	18	6.0	0.78	7.3	0.94	8.5	1.14	9.1	1.22	9.6	1.40	10.9	1.56	12.0	1.23
	20	6.0	0.80	7.3	0.97	8.5	1.17	9.1	1.28	9.6	1.46	10.9	1.60	12.0	1.30
	21	6.0	0.82	7.3	0.98	8.5	1.68	9.1	1.32	9.6	1.52	10.9	1.64	12.0	1.33
	23	6.0	0.83	7.3	1.02	8.5	1.28	9.1	1.38	9.6	1.55	10.9	1.70	12.0	1.40
	25	6.0	0.86	7.3	1.11	8.5	1.37	9.1	1.47	9.6	1.63	10.9	1.75	12.0	1.49
	27	6.0	0.93	7.3	1.16	8.5	1.44	9.1	1.62	9.6	1.72	10.9	1.83	12.0	1.63
	29	6.0	0.97	7.3	1.28	8.5	1.56	9.1	1.74	9.6	1.83	10.9	1.92	12.0	1.75
	31	6.0	1.06	7.3	1.34	8.5	1.66	9.1	1.86	9.6	1.93	10.9	1.96	12.0	1.87
	33	6.0	1.14	7.3	1.44	8.5	1.78	9.1	2.00	9.6	1.94	10.9	2.05	12.0	2.01
	35	6.0	1.20	7.3	1.53	8.5	1.91	9.1	2.14	9.6	2.15	10.9	2.16	12.0	2.17
	37	6.0	1.26	7.3	1.63	8.5	2.04	9.1	2.22	9.6	2.19	10.9	2.23	12.0	2.25
	39	6.0	1.32	7.3	1.74	8.5	2.16	9.1	2.26	9.6	2.26	10.9	2.31	12.0	2.28
	41	6.0	1.37	7.3	1.78	8.5	2.21	9.1	2.30	9.6	2.32	10.8	2.35	11.9	2.32
	43	6.0	1.43	7.3	1.81	8.5	2.26	9.1	2.34	9.5	2.37	10.6	2.39	11.7	2.37
	45	6.0	1.46	7.3	1.84	8.5	2.30	8.9	2.38	9.5	2.38	10.5	2.48	11.5	2.41
	47	6.0	1.49	7.3	1.94	8.5	2.34	8.8	2.43	9.4	2.47	10.3	2.52	11.4	2.45
	48	6.0	1.56	7.3	1.96	8.5	2.39	8.7	2.47	9.2	2.56	10.2	2.59	11.2	2.50
	29	3.9	0.52	4.5	0.68	5.3	0.84	5.7	0.93	6.2	0.98	6.8	1.03	7.6	0.94
	31	3.9	0.57	4.5	0.72	5.3	0.89	5.7	0.99	6.2	1.03	6.8	1.05	7.6	1.00
	33	3.9	0.60	4.5	0.77	5.3	0.95	5.7	1.06	6.2	1.04	6.8	1.10	7.6	1.08
	35	3.9	0.64	4.5	0.82	5.3	1.02	5.7	1.15	6.2	1.15	6.8	1.16	7.6	1.16
	37	3.9	0.67	4.5	0.87	5.3	1.09	5.7	1.19	6.2	1.18	6.8	1.19	7.6	1.20
	39	3.9	0.71	4.5	0.93	5.3	1.16	5.7	1.21	6.2	1.21	6.8	1.24	7.6	1.22
	41	3.9	0.73	4.5	0.95	5.3	1.18	5.7	1.23	6.2	1.24	6.8	1.26	7.6	1.24
43	3.9	0.76	4.5	0.97	5.3	1.21	5.7	1.25	6.2	1.27	6.8	1.28	7.6	1.26	
45	3.9	0.79	4.5	0.98	5.3	1.24	5.7	1.28	6.2	1.28	6.8	1.33	7.6	1.29	
47	3.9	0.80	4.5	1.04	5.3	1.25	5.7	1.30	6.2	1.32	6.8	1.35	7.6	1.31	
48	3.9	0.83	4.5	1.05	5.3	1.28	5.7	1.32	6.2	1.37	6.8	1.38	7.6	1.33	

GMV-S140WL/A-S

TC—represents capacity of outdoor unit; PI—represents power of outdoor unit

Operating capacity (%)	Outdoor ambient temperature (°CDB)	Indoor ambient temperature (°C)													
		14.0°C WB		16.0°C WB		18.0°C WB		19.0°C WB		20.0°C WB		22.0°C WB		24.0°C WB	
		20.0°C DB		23.0°C DB		26.0°C DB		27.0°C DB		28.0°C DB		30.0°C DB		32.0°C DB	
		TC	PI	TC	PI	TC	PI	TC	PI	TC	PI	TC	PI	TC	PI

GMV5 Home DC Inverter Multi VRF Units

		kW	kW	kW	kW	kW	kW	kW	kW	kW	kW	kW	kW	kW	kW
100%	10	8.8	1.32	10.4	1.62	12.4	1.93	13.1	2.09	13.9	2.22	15.7	2.55	16.6	2.11
	12	8.8	1.36	10.4	1.65	12.4	1.96	13.1	2.13	13.9	2.29	15.7	2.60	16.3	2.14
	14	8.8	1.37	10.4	1.66	12.4	2.00	13.1	2.15	13.9	2.37	15.7	2.66	16.2	2.17
	15	8.8	1.40	10.4	1.71	12.4	2.04	13.1	2.18	13.9	2.45	15.6	2.76	15.9	2.20
	18	8.8	1.43	10.4	1.73	12.4	2.09	13.1	2.23	13.9	2.57	15.5	2.87	15.8	2.25
	20	8.8	1.47	10.4	1.78	12.4	2.15	13.1	2.35	13.9	2.69	15.2	2.93	15.5	2.37
	21	8.8	1.50	10.4	1.82	12.4	2.21	13.1	2.42	13.9	2.79	15.1	3.01	15.4	2.44
	23	8.8	1.53	10.4	1.88	12.4	2.35	13.1	2.54	13.9	2.85	14.9	3.13	15.1	2.57
	25	8.8	1.58	10.4	2.04	12.4	2.51	13.1	2.70	13.9	3.00	14.6	3.21	15.0	2.73
	27	8.8	1.71	10.4	2.13	12.4	2.65	13.1	2.98	13.9	3.17	14.5	3.36	14.8	3.00
	29	8.8	1.78	10.4	2.35	12.4	2.88	13.1	3.19	13.8	3.36	14.3	3.53	14.5	3.22
	31	8.8	1.96	10.4	2.45	12.4	3.04	13.1	3.41	13.7	3.54	14.0	3.61	14.3	3.45
	33	8.8	2.09	10.4	2.65	12.4	3.27	13.1	3.66	13.5	3.55	13.8	3.76	14.1	3.70
	35	8.8	2.20	10.4	2.80	12.4	3.50	13.1	3.94	13.2	3.95	13.5	3.96	14.0	3.98
	37	8.8	2.31	10.4	3.00	12.4	3.74	12.8	4.08	13.1	4.03	13.4	4.10	13.7	4.12
	39	8.8	2.42	10.4	3.19	12.4	3.97	12.6	4.14	12.8	4.15	13.1	4.24	13.5	4.19
	41	8.8	2.53	10.4	3.27	12.4	4.06	12.6	4.22	12.8	4.25	13.1	4.32	13.4	4.26
	43	8.8	2.62	10.4	3.32	12.4	4.14	12.6	4.30	12.6	4.35	13.0	4.40	13.2	4.34
45	8.8	2.69	10.4	3.38	12.2	4.22	12.4	4.38	12.5	4.39	12.9	4.56	13.1	4.42	
47	8.8	2.75	10.4	3.56	12.1	4.31	12.2	4.46	12.4	4.54	12.8	4.64	12.9	4.50	
48	8.8	2.85	10.4	3.61	12.0	4.40	12.1	4.53	12.3	4.70	12.7	4.76	12.8	4.58	
90%	10	8.0	1.11	9.5	1.36	11.0	1.62	11.8	1.75	12.6	1.86	14.2	2.14	15.6	1.77
	12	8.0	1.14	9.5	1.38	11.0	1.65	11.8	1.78	12.6	1.93	14.2	2.19	15.6	1.80
	14	8.0	1.16	9.5	1.40	11.0	1.68	11.8	1.81	12.6	1.99	14.2	2.23	15.6	1.83
	15	8.0	1.18	9.5	1.44	11.0	1.72	11.8	1.83	12.6	2.06	14.2	2.32	15.6	1.85
	18	8.0	1.20	9.5	1.46	11.0	1.75	11.8	1.87	12.6	2.16	14.2	2.41	1.6	1.89
	20	8.0	1.24	9.5	1.49	11.0	1.81	11.8	1.97	12.6	2.26	14.2	2.46	15.2	1.99
	21	8.0	1.26	9.5	1.52	11.0	2.21	11.8	2.04	12.6	2.34	14.2	2.53	15.1	2.05
	23	8.0	1.28	9.5	1.57	11.0	1.97	11.8	2.13	12.6	2.39	14.2	2.63	14.7	2.16
	25	8.0	1.33	9.5	1.71	11.0	2.12	11.8	2.27	12.6	2.52	14.2	2.70	14.5	2.30
	27	8.0	1.44	9.5	1.78	11.0	2.23	11.8	2.51	12.6	2.66	14.1	2.83	14.4	2.52
	29	8.0	1.50	9.5	1.98	11.0	2.42	11.8	2.68	12.6	2.82	14.0	2.97	14.3	2.70
	31	8.0	1.65	9.5	2.06	11.0	2.55	11.8	2.87	12.6	2.97	13.8	3.03	14.0	2.89
	33	8.0	1.75	9.5	2.23	11.0	2.74	11.8	3.08	12.6	2.98	13.5	3.17	13.8	3.10
	35	8.0	1.85	9.5	2.35	11.0	2.94	11.8	3.31	12.6	3.32	13.3	3.33	13.6	3.35
	37	8.0	1.94	9.5	2.52	11.0	3.15	11.8	3.43	12.6	3.38	12.9	3.45	13.3	3.46
	39	8.0	2.04	9.5	2.68	11.0	3.34	11.8	3.48	12.6	3.48	12.8	3.56	13.1	3.52
	41	8.0	2.13	9.5	2.75	11.0	3.41	11.8	3.55	12.4	3.57	12.6	3.63	13.0	3.58
	43	8.0	2.20	9.5	2.79	11.0	3.48	11.7	3.61	12.4	3.65	12.5	3.70	12.8	3.65
45	8.0	2.25	9.5	2.84	11.0	3.55	11.5	3.68	12.3	3.68	12.4	3.83	12.7	3.72	
47	8.0	2.31	9.5	2.99	11.0	3.62	11.3	3.74	12.1	3.82	12.2	3.90	12.5	3.78	
48	8.0	2.40	9.5	3.03	11.0	3.69	11.3	3.81	11.9	3.95	12.1	4.00	12.4	3.84	
80%	10	7.0	0.94	8.4	1.15	9.9	1.37	10.5	1.48	11.2	1.57	12.6	1.81	14.0	1.49
	12	7.0	0.97	8.4	1.17	9.9	1.39	10.5	1.51	11.2	1.63	12.6	1.85	13.9	1.52
	14	7.0	0.98	8.4	1.18	9.9	1.42	10.5	1.53	11.2	1.68	12.6	1.88	13.9	1.54
	15	7.0	0.99	8.4	1.21	9.9	1.46	10.5	1.55	11.2	1.74	12.6	1.95	13.9	1.56
	18	7.0	1.01	8.4	1.23	9.9	1.48	10.5	1.58	11.2	1.83	12.6	2.04	13.9	1.60
	20	7.0	1.05	8.4	1.27	9.9	1.53	10.5	1.67	11.2	1.91	12.6	2.08	13.9	1.68

GMV5 Home DC Inverter Multi VRF Units

	21	7.0	1.07	8.4	1.28	9.9	2.21	10.5	1.72	11.2	1.98	12.6	2.13	13.9	1.74
	23	7.0	1.09	8.4	1.33	9.9	1.66	10.5	1.81	11.2	2.02	12.6	2.23	13.9	1.83
	25	7.0	1.12	8.4	1.45	9.9	1.79	10.5	1.92	11.2	2.13	12.6	2.28	13.9	1.94
	27	7.0	1.21	8.4	1.51	9.9	1.88	10.5	2.12	11.2	2.24	12.6	2.39	13.9	2.13
	29	7.0	1.27	8.4	1.67	9.9	2.04	10.5	2.26	11.2	2.39	12.6	2.51	13.9	2.29
	31	7.0	1.39	8.4	1.75	9.9	2.16	10.5	2.42	11.2	2.51	12.6	2.56	13.9	2.44
	33	7.0	1.48	8.4	1.88	9.9	2.32	10.5	2.60	11.2	2.52	12.6	2.68	13.9	2.62
	35	7.0	1.56	8.4	1.99	9.9	2.49	10.5	2.80	11.2	2.80	12.6	2.81	13.9	2.83
	37	7.0	1.64	8.4	2.13	9.9	2.66	10.5	2.89	11.2	2.86	12.6	2.91	13.9	2.92
	39	7.0	1.72	8.4	2.26	9.9	2.82	10.5	2.94	11.2	2.95	12.6	3.01	13.9	2.98
	41	7.0	1.80	8.4	2.32	9.9	2.89	10.5	2.99	11.2	3.01	12.4	3.07	13.7	3.03
	43	7.0	1.86	8.4	2.35	9.9	2.94	10.5	3.05	11.1	3.08	12.3	3.12	13.5	3.08
	45	7.0	1.91	8.4	2.40	9.9	3.00	10.3	3.11	11.0	3.11	12.1	3.24	13.4	3.14
	47	7.0	1.95	8.4	2.53	9.9	3.06	10.2	3.17	10.8	3.23	12.0	3.29	13.2	3.19
	48	7.0	2.03	8.4	2.56	9.9	3.12	10.1	3.22	10.6	3.34	11.8	3.37	13.0	3.26

GMV-S160WL/A-S

TC—represents capacity of outdoor unit; PI—represents power of outdoor unit

Operating capacity	Outdoor ambient temperature (°CDB)	Indoor ambient temperature (°C)													
		14.0°C WB		16.0°C WB		18.0°C WB		19.0°C WB		20.0°C WB		22.0°C WB		24.0°C WB	
		20.0°C DB		23.0°C DB		26.0°C DB		27.0°C DB		28.0°C DB		30.0°C DB		32.0°C DB	
		TC	PI	TC	PI	TC	PI	TC	PI	TC	PI	TC	PI	TC	PI
		kW	kW	kW	kW	kW	kW	kW	kW	kW	kW	kW	kW	kW	kW
100%	10	10.1	1.61	12.0	1.97	14.1	2.35	15.1	2.54	16.0	2.69	18.0	3.10	19.0	2.56
	12	10.1	1.65	12.0	2.01	14.1	2.39	15.1	2.58	16.0	2.79	18.0	3.17	18.7	2.61
	14	10.1	1.68	12.0	2.02	14.1	2.44	15.1	2.61	16.0	2.88	18.0	3.23	18.5	2.64
	15	10.1	1.71	12.0	2.08	14.1	2.49	15.1	2.65	16.0	2.98	17.9	3.35	18.3	2.68
	18	10.1	1.74	12.0	2.10	14.1	2.54	15.1	2.72	16.0	3.12	17.7	3.49	18.2	2.75
	20	10.1	1.79	12.0	2.16	14.1	2.62	15.1	2.86	16.0	3.27	17.4	3.57	17.8	2.89
	21	10.1	1.83	12.0	2.21	14.1	2.68	15.1	2.95	16.0	3.39	17.3	3.66	17.6	2.98
	23	10.1	1.86	12.0	2.28	14.1	2.86	15.1	3.09	16.0	3.46	17.1	3.81	17.4	3.12
	25	10.1	1.93	12.0	2.48	14.1	3.07	15.1	3.30	16.0	3.65	16.8	3.90	17.2	3.33
	27	10.1	2.08	12.0	2.58	14.1	3.22	15.1	3.62	16.0	3.85	16.6	4.10	17.0	3.66
	29	10.1	2.17	12.0	2.86	14.1	3.50	15.1	3.88	15.9	4.09	16.4	4.29	16.7	3.92
	31	10.1	2.38	12.0	2.99	14.1	3.70	15.1	4.15	15.7	4.31	16.1	4.39	16.4	4.19
	33	10.1	2.54	12.0	3.22	14.1	3.98	15.1	4.45	15.4	4.33	15.9	4.58	16.2	4.50
	35	10.1	2.68	12.0	3.41	14.1	4.26	15.1	4.80	15.2	4.81	15.5	4.82	16.0	4.85
	37	10.1	2.81	12.0	3.66	14.1	4.56	14.8	4.96	15.0	4.91	15.3	4.98	15.7	5.01
	39	10.1	2.95	12.0	3.88	14.1	4.84	14.5	5.04	14.7	5.05	15.1	5.16	15.4	5.10
	41	10.1	3.08	12.0	3.99	14.1	4.95	14.5	5.14	14.7	5.17	15.1	5.26	15.3	5.19
	43	10.1	3.19	12.0	4.04	14.1	5.04	14.5	5.23	14.5	5.29	15.0	5.36	15.2	5.28
45	10.1	3.27	12.0	4.12	14.0	5.15	14.2	5.33	14.4	5.34	14.9	5.55	15.1	5.38	
47	10.1	3.35	12.0	4.34	13.8	5.24	14.0	5.43	14.1	5.53	14.7	5.65	14.9	5.48	
48	10.1	3.47	12.0	4.40	13.7	5.35	13.8	5.52	14.0	5.73	14.6	5.79	14.8	5.57	
90%	10	9.1	1.36	11.0	1.65	12.6	1.98	13.6	2.13	14.5	2.27	16.3	2.60	17.9	2.15
	12	9.1	1.39	11.0	1.69	12.6	2.01	13.6	2.17	14.5	2.34	16.3	2.67	17.9	2.19
	14	9.1	1.41	11.0	1.71	12.6	2.04	13.6	2.20	14.5	2.42	16.3	2.72	17.9	2.22
	15	9.1	1.44	11.0	1.74	12.6	2.09	13.6	2.23	14.5	2.51	16.3	2.81	17.9	2.25
	18	9.1	1.47	11.0	1.77	12.6	2.13	13.6	2.28	14.5	2.62	16.3	2.93	1.8	2.30
	20	9.1	1.50	11.0	1.82	12.6	2.20	13.6	2.40	14.5	2.75	16.3	3.00	17.5	2.43

GMV5 Home DC Inverter Multi VRF Units

	21	9.1	1.53	11.0	1.85	12.6	2.68	13.6	2.48	14.5	2.84	16.3	3.08	17.3	2.50
	23	9.1	1.56	11.0	1.92	12.6	2.40	13.6	2.60	14.5	2.91	16.3	3.20	16.9	2.63
	25	9.1	1.62	11.0	2.08	12.6	2.57	13.6	2.77	14.5	3.08	16.3	3.29	16.7	2.80
	27	9.1	1.74	11.0	2.17	12.6	2.71	13.6	3.05	14.5	3.23	16.2	3.44	16.5	3.08
	29	9.1	1.82	11.0	2.41	12.6	2.94	13.6	3.26	14.5	3.43	16.1	3.61	16.4	3.30
	31	9.1	2.01	11.0	2.51	12.6	3.10	13.6	3.49	14.5	3.62	15.8	3.69	16.0	3.52
	33	9.1	2.14	11.0	2.71	12.6	3.35	13.6	3.74	14.5	3.63	15.5	3.85	15.9	3.78
	35	9.1	2.25	11.0	2.86	12.6	3.58	13.6	4.03	14.5	4.04	15.2	4.05	15.6	4.07
	37	9.1	2.36	11.0	3.08	12.6	3.83	13.6	4.17	14.5	4.13	14.9	4.19	15.2	4.21
	39	9.1	2.48	11.0	3.26	12.6	4.07	13.6	4.24	14.5	4.24	14.7	4.34	15.1	4.28
	41	9.1	2.58	11.0	3.35	12.6	4.15	13.6	4.32	14.2	4.35	14.5	4.42	14.9	4.36
	43	9.1	2.68	11.0	3.39	12.6	4.23	13.5	4.40	14.1	4.44	14.3	4.50	14.7	4.44
	45	9.1	2.75	11.0	3.45	12.6	4.32	13.3	4.47	14.0	4.48	14.2	4.66	14.6	4.52
	47	9.1	2.81	11.0	3.64	12.6	4.41	13.0	4.56	13.8	4.65	14.0	4.74	14.4	4.60
	48	9.1	2.91	11.0	3.69	12.6	4.49	13.0	4.64	13.6	4.81	13.8	4.86	14.2	4.69
80%	10	8.1	1.15	9.7	1.40	11.3	1.67	12.0	1.80	12.8	1.91	14.5	2.20	16.0	1.82
	12	8.1	1.18	9.7	1.43	11.3	1.70	12.0	1.83	12.8	1.98	14.5	2.26	16.0	1.85
	14	8.1	1.19	9.7	1.44	11.3	1.74	12.0	1.86	12.8	2.05	14.5	2.29	16.0	1.88
	15	8.1	1.21	9.7	1.47	11.3	1.76	12.0	1.88	12.8	2.12	14.5	2.38	16.0	1.90
	18	8.1	1.23	9.7	1.49	11.3	1.80	12.0	1.93	12.8	2.22	14.5	2.48	16.0	1.95
	20	8.1	1.27	9.7	1.53	11.3	1.86	12.0	2.03	12.8	2.32	14.5	2.54	16.0	2.05
	21	8.1	1.30	9.7	1.57	11.3	2.68	12.0	2.09	12.8	2.41	14.5	2.60	16.0	2.11
	23	8.1	1.32	9.7	1.62	11.3	2.03	12.0	2.20	12.8	2.46	14.5	2.71	16.0	2.22
	25	8.1	1.37	9.7	1.76	11.3	2.18	12.0	2.34	12.8	2.59	14.5	2.78	16.0	2.36
	27	8.1	1.47	9.7	1.83	11.3	2.28	12.0	2.57	12.8	2.73	14.5	2.91	16.0	2.60
	29	8.1	1.54	9.7	2.03	11.3	2.49	12.0	2.76	12.8	2.90	14.5	3.05	16.0	2.79
	31	8.1	1.70	9.7	2.12	11.3	2.63	12.0	2.95	12.8	3.06	14.5	3.11	16.0	2.98
	33	8.1	1.80	9.7	2.28	11.3	2.82	12.0	3.16	12.8	3.08	14.5	3.26	16.0	3.19
	35	8.1	1.90	9.7	2.42	11.3	3.03	12.0	3.41	12.8	3.41	14.5	3.42	16.0	3.44
	37	8.1	2.00	9.7	2.59	11.3	3.24	12.0	3.53	12.8	3.48	14.5	3.54	16.0	3.56
39	8.1	2.09	9.7	2.76	11.3	3.43	12.0	3.59	12.8	3.59	14.5	3.66	16.0	3.62	
41	8.1	2.19	9.7	2.83	11.3	3.51	12.0	3.64	12.8	3.67	14.3	3.73	15.8	3.68	
43	8.1	2.27	9.7	2.86	11.3	3.58	12.0	3.71	12.7	3.76	14.1	3.80	15.5	3.75	
45	8.1	2.32	9.7	2.92	11.3	3.65	11.9	3.78	12.6	3.79	13.9	3.94	15.3	3.82	
47	8.1	2.38	9.7	3.08	11.3	3.72	11.6	3.86	12.4	3.92	13.7	4.01	15.2	3.89	
48	8.1	2.46	9.7	3.12	11.3	3.80	11.5	3.92	12.2	4.07	13.6	4.11	15.0	3.96	

GMV-S224W/A-X

TC—represents capacity of outdoor unit; PI—represents power of outdoor unit															
Capacity collocation rate of indoor and outdoor units	Outdoor ambient temperature (°C DB)	Indoor ambient temperature													
		14.0°C WB		16.0°C WB		18.0°C WB		19.0°C WB		20.0°C WB		22.0°C WB		24.0°C WB	
		20.0°C DB		23.0°C DB		26.0°C DB		27.0°C DB		28.0°C DB		30.0°C DB		32.0°C DB	
		TC	PI	TC	PI	TC	PI	TC	PI	TC	PI	TC	PI	TC	PI
		kW	kW	kW	kW	kW	kW	kW	kW	kW	kW	kW	kW	kW	
100%	10	15.1	1.85	18.0	2.24	21.0	2.65	22.4	2.86	23.8	3.09	26.8	3.50	28.3	3.64
	12	15.1	1.87	18.0	2.27	21.0	2.69	22.4	2.90	23.8	3.15	26.8	3.56	27.9	3.61
	14	15.1	1.90	18.0	2.31	21.0	2.73	22.4	2.95	23.8	3.21	26.8	3.62	27.6	3.58

GMV5 Home DC Inverter Multi VRF Units

	16	15.1	1.95	18.0	2.36	21.0	2.80	22.4	3.02	23.8	3.28	26.7	3.70	27.2	3.66
	18	15.1	1.99	18.0	2.42	21.0	2.85	22.4	3.08	23.8	3.35	26.3	3.78	26.9	3.83
	20	15.1	2.02	18.0	2.45	21.0	2.94	22.4	3.24	23.8	3.56	25.9	3.97	26.5	4.03
	21	15.1	2.04	18.0	2.48	21.0	3.04	22.4	3.35	23.8	3.68	25.8	4.11	26.3	4.15
	23	15.1	2.09	18.0	2.65	21.0	3.27	22.4	3.60	23.8	3.96	25.4	4.35	25.9	4.39
	25	15.1	2.23	18.0	2.82	21.0	3.48	22.4	3.83	23.8	4.23	25.0	4.51	25.6	4.55
	27	15.1	2.38	18.0	3.01	21.0	3.74	22.4	4.11	23.8	4.54	24.6	4.67	25.2	4.71
	29	15.1	2.52	18.0	3.21	21.0	4.00	22.4	4.40	23.8	4.81	24.3	4.89	24.9	4.93
	31	15.1	2.68	18.0	3.42	21.0	4.26	22.4	4.74	23.5	5.01	23.7	5.09	24.5	5.13
	33	15.1	2.85	18.0	3.65	21.0	4.54	22.4	5.02	23.0	5.19	23.6	5.24	24.1	5.28
	35	15.1	3.03	18.0	3.88	21.0	4.84	22.4	5.35	22.6	5.38	23.2	5.43	23.7	5.47
	37	15.1	3.23	18.0	4.14	21.0	5.16	22.0	5.54	22.4	5.57	22.8	5.61	23.4	5.66
	39	15.1	3.44	18.0	4.40	21.0	5.49	21.7	5.73	21.8	5.75	22.6	5.79	22.8	5.85
90%	10	13.6	1.61	16.2	1.93	18.9	2.27	20.2	2.55	21.5	2.72	24.1	3.11	26.7	3.53
	12	13.6	1.63	16.2	1.96	18.9	2.29	20.2	2.59	21.5	2.77	24.1	3.17	26.7	3.57
	14	13.6	1.66	16.2	1.99	18.9	2.33	20.2	2.62	21.5	2.82	24.1	3.22	26.7	3.63
	16	13.6	1.70	16.2	2.04	18.9	2.39	20.2	2.68	21.5	2.88	24.1	3.29	26.6	3.70
	18	13.6	1.74	16.2	2.08	18.9	2.43	20.2	2.74	21.5	2.94	24.1	3.37	26.4	3.84
	20	13.6	1.76	16.2	2.12	18.9	2.51	20.2	2.79	21.5	3.06	24.1	3.62	32.4	4.00
	21	13.6	1.78	16.2	2.14	18.9	2.60	20.2	2.88	21.5	3.16	24.1	3.74	32.2	4.09
	23	13.6	1.83	16.2	2.28	18.9	2.80	20.2	3.10	21.5	3.39	24.1	4.02	31.7	4.30
	25	13.6	1.94	16.2	2.43	18.9	2.97	20.2	3.31	21.5	3.62	24.1	4.30	31.3	4.47
	27	13.6	2.07	16.2	2.60	18.9	3.19	20.2	3.53	21.5	3.88	24.1	4.59	30.8	4.67
	29	13.6	2.20	16.2	2.77	18.9	3.41	20.2	3.77	21.5	4.14	29.8	4.81	30.4	4.86
	31	13.6	2.34	16.2	2.95	18.9	3.64	20.2	4.03	21.5	4.42	29.3	4.99	29.9	5.05
	33	13.6	2.49	16.2	3.14	18.9	3.88	20.2	4.29	21.5	4.70	28.9	5.19	29.5	5.24
35	13.6	2.65	16.2	3.35	18.9	4.13	20.2	4.57	21.5	5.03	28.4	5.38	29.0	5.43	
37	13.6	2.82	16.2	3.57	18.9	4.40	19.8	4.73	21.5	5.38	27.9	5.57	28.6	5.56	
39	13.6	3.00	16.2	3.80	18.9	4.69	19.5	4.89	21.5	5.70	27.5	5.78	28.1	5.76	
80%	10	12.1	2.03	14.4	2.43	16.8	2.86	17.9	3.08	19.1	2.38	21.4	2.72	29.7	3.15
	12	12.1	2.06	14.4	2.47	16.8	2.91	17.9	3.14	19.1	2.42	21.4	2.76	29.7	3.13
	14	12.1	2.10	14.4	2.52	16.8	2.96	17.9	3.19	19.1	2.47	21.4	2.81	29.7	3.20
	16	12.1	2.13	14.4	2.56	16.8	3.02	17.9	3.25	19.1	2.51	21.4	2.87	29.7	3.32
	18	12.1	2.17	14.4	2.61	16.8	3.09	17.9	3.32	19.1	2.55	21.4	2.94	29.7	3.55
	20	12.1	2.21	14.4	2.66	16.8	3.14	17.9	3.38	19.1	2.61	21.4	3.05	29.7	3.68
	21	12.1	2.23	14.4	2.68	16.8	3.17	17.9	3.42	19.1	2.67	21.4	3.16	29.7	3.93
	23	12.1	2.27	14.4	2.74	16.8	3.32	17.9	3.64	19.1	2.86	21.4	3.38	29.7	4.21
	25	12.1	2.34	14.4	2.91	16.8	3.55	17.9	3.89	19.1	3.05	21.4	3.61	29.7	4.49
	27	12.1	2.49	14.4	3.10	16.8	3.78	17.9	4.15	19.1	3.27	21.4	3.86	29.7	4.65
	29	12.1	2.65	14.4	3.30	16.8	4.03	17.9	4.42	19.0	3.49	21.4	4.12	29.7	4.82
	31	12.1	2.81	14.4	3.51	16.8	4.29	17.9	4.71	19.0	3.72	21.4	4.39	29.2	4.99
	33	12.1	2.99	14.4	3.91	16.8	4.57	17.9	3.62	19.0	3.96	21.4	4.69	28.8	5.17
35	12.1	3.17	14.4	3.91	16.8	4.86	17.9	3.86	19.0	4.22	21.4	5.00	28.3	5.36	
37	12.1	3.36	14.4	4.21	16.8	5.17	17.6	4.11	19.0	4.49	21.4	5.33	27.9	5.56	
39	12.1	3.56	14.4	4.47	16.8	5.50	17.4	4.38	19.0	4.78	21.4	5.68	27.4	5.77	

GMV5 Home DC Inverter Multi VRF Units

GMV-S280W/A-X

TC—represents capacity of outdoor unit; PI—represents power of outdoor unit															
Capacity collocation rate of indoor and outdoor unit	Outdoor ambient temperature (°C DB)	Indoor ambient temperature													
		14.0°C WB		16.0°C WB		18.0°C WB		19.0°C WB		20.0°C WB		22.0°C WB		24.0°C WB	
		20.0°C DB		23.0°C DB		26.0°C DB		27.0°C DB		28.0°C DB		30.0°C DB		32.0°C DB	
		TC	PI	TC	PI	TC	PI	TC	PI	TC	PI	TC	PI	TC	PI
		kW	kW	kW	kW	kW	kW	kW	kW	kW	kW	kW	kW	kW	
100%	10	18.9	2.66	22.5	3.23	26.2	3.82	28.0	4.12	29.8	4.45	33.5	5.04	35.4	5.24
	12	18.9	2.69	22.5	3.27	26.2	3.87	28.0	4.18	29.8	4.54	33.5	5.12	34.9	5.19
	14	18.9	2.74	22.5	3.33	26.2	3.93	28.0	4.25	29.8	4.62	33.5	5.21	34.5	5.15
	16	18.9	2.80	22.5	3.40	26.2	4.02	28.0	4.35	29.8	4.72	33.4	5.33	34.0	5.27
	18	18.9	2.86	22.5	3.48	26.2	4.10	28.0	4.43	29.8	4.82	32.9	5.43	33.6	5.52
	20	18.9	2.91	22.5	3.53	26.2	4.24	28.0	4.67	29.8	5.12	32.4	5.72	33.1	5.81
	21	18.9	2.94	22.5	3.57	26.2	4.38	28.0	4.83	29.8	5.30	32.2	5.91	32.9	5.97
	23	18.9	3.01	22.5	3.81	26.2	4.71	28.0	5.19	29.8	5.70	31.8	6.26	32.4	6.32
	25	18.9	3.20	22.5	4.05	26.2	5.01	28.0	5.52	29.8	6.09	31.3	6.49	32.0	6.54
	27	18.9	3.42	22.5	4.33	26.2	5.38	28.0	5.92	29.8	6.54	30.8	6.71	31.5	6.77
	29	18.9	3.63	22.5	4.63	26.2	5.75	28.0	6.33	29.7	6.93	30.4	7.04	31.1	7.10
	31	18.9	3.86	22.5	4.93	26.2	6.13	28.0	6.83	29.3	7.21	29.7	7.32	30.6	7.39
	33	18.9	4.10	22.5	5.25	26.2	6.54	28.0	7.22	28.8	7.47	29.5	7.53	30.2	7.60
	35	18.9	4.36	22.5	5.59	26.2	6.97	28.0	7.70	28.3	7.74	29.0	7.81	29.7	7.88
	37	18.9	4.65	22.5	5.95	26.2	7.42	27.5	7.98	27.9	8.02	28.6	8.07	29.3	8.15
39	18.9	4.95	22.5	6.34	26.2	7.90	27.1	8.24	27.3	8.28	28.2	8.34	28.6	8.42	
90%	10	17.0	2.32	20.2	2.78	23.6	3.26	25.2	3.67	26.8	3.91	30.1	4.48	33.4	5.08
	12	17.0	2.35	20.2	2.82	23.6	3.30	25.2	3.72	26.8	3.99	30.1	4.56	33.4	5.14
	14	17.0	2.39	20.2	2.87	23.6	3.36	25.2	3.78	26.8	4.05	30.1	4.64	33.4	5.23
	16	17.0	2.44	20.2	2.93	23.6	3.44	25.2	3.86	26.8	4.15	30.1	4.74	33.3	5.33
	18	17.0	2.50	20.2	3.00	23.6	3.50	25.2	3.94	26.8	4.23	30.1	4.85	33.0	5.52
	20	17.0	2.54	20.2	3.05	23.6	3.62	25.2	4.02	26.8	4.40	30.1	5.21	32.4	5.75
	21	17.0	2.56	20.2	3.08	23.6	3.74	25.2	4.15	26.8	4.55	30.1	5.39	32.2	5.88
	23	17.0	2.63	20.2	3.29	23.6	4.02	25.2	4.46	26.8	4.87	30.1	5.79	31.7	6.18
	25	17.0	2.79	20.2	3.50	23.6	4.28	25.2	4.76	26.8	5.21	30.1	6.19	31.3	6.43
	27	17.0	2.99	20.2	3.74	23.6	4.59	25.2	5.09	26.8	5.58	30.1	6.61	30.8	6.72
	29	17.0	3.16	20.2	3.99	23.6	4.91	25.2	5.43	26.8	5.96	29.8	6.93	30.4	6.99
	31	17.0	3.36	20.2	4.25	23.6	5.24	25.2	5.80	26.8	6.36	29.3	7.18	29.9	7.27
	33	17.0	3.58	20.2	4.53	23.6	5.58	25.2	6.17	26.8	6.76	28.9	7.47	29.5	7.54
	35	17.0	3.81	20.2	4.82	23.6	5.95	25.2	6.58	26.8	7.23	28.4	7.74	29.0	7.81
	37	17.0	4.06	20.2	5.13	23.6	6.34	24.7	6.81	26.8	7.74	27.9	8.02	28.6	8.00
39	17.0	4.32	20.2	5.47	23.6	6.75	24.4	7.04	26.8	8.20	27.5	8.32	28.1	8.29	
80%	10	15.1	2.03	18.0	2.43	21.0	2.86	22.4	3.08	23.8	3.42	26.8	3.91	29.7	4.54
	12	15.1	2.06	18.0	2.47	21.0	2.91	22.4	3.14	23.8	3.49	26.8	3.98	29.7	4.50
	14	15.1	2.10	18.0	2.52	21.0	2.96	22.4	3.19	23.8	3.55	26.8	4.05	29.7	4.61
	16	15.1	2.13	18.0	2.56	21.0	3.02	22.4	3.25	23.8	3.61	26.8	4.14	29.7	4.77
	18	15.1	2.17	18.0	2.61	21.0	3.09	22.4	3.32	23.8	3.68	26.8	4.23	29.7	5.10

GMV5 Home DC Inverter Multi VRF Units

20	15.1	2.21	18.0	2.66	21.0	3.14	22.4	3.38	23.8	3.76	26.8	4.38	29.7	5.29
21	15.1	2.23	18.0	2.68	21.0	3.17	22.4	3.42	23.8	3.84	26.8	4.54	29.7	5.66
23	15.1	2.27	18.0	2.74	21.0	3.32	22.4	3.64	23.8	4.11	26.8	4.86	29.7	6.06
25	15.1	2.34	18.0	2.91	21.0	3.55	22.4	3.89	23.8	4.39	26.8	5.20	29.7	6.46
27	15.1	2.49	18.0	3.10	21.0	3.78	22.4	4.15	23.8	4.71	26.8	5.55	29.7	6.69
29	15.1	2.65	18.0	3.30	21.0	4.03	22.4	4.42	23.8	5.02	26.8	5.93	29.7	6.93
31	15.1	2.81	18.0	3.51	21.0	4.29	22.4	4.71	23.8	5.35	26.8	6.32	29.2	7.19
33	15.1	2.99	18.0	3.91	21.0	4.57	22.4	5.21	23.8	5.70	26.8	6.75	28.8	7.45
35	15.1	3.17	18.0	3.91	21.0	4.86	22.4	5.55	23.8	6.07	26.8	7.20	28.3	7.72
37	15.1	3.36	18.0	4.21	21.0	5.17	22.0	5.91	23.8	6.46	26.8	7.67	27.9	8.00
39	15.1	3.56	18.0	4.47	21.0	5.50	21.7	6.30	23.8	6.88	26.8	8.17	27.4	8.30

7.3.2 Revision of heating capacity

GMV-S120WL/A-S

TC—represents capacity of outdoor unit; PI—represents power of outdoor unit														
Capacity collocation rate of indoor and outdoor units	Outdoor ambient temperature		Indoor ambient temperature °C DB											
			16		18		20		21		22		24	
	°C DB	°C WB	TC	PI	TC	PI	TC	PI	TC	PI	TC	PI	TC	PI
100%	-19.8	-20.0	5.6	2.36	5.6	2.48	5.6	2.73	5.6	2.80	5.6	2.81	5.6	2.89
	-18.8	-19.0	6.8	2.43	6.7	2.67	6.7	2.83	6.7	2.91	6.7	2.92	6.7	2.94
	-16.7	-17.0	7.7	2.47	7.7	2.73	7.7	2.93	7.7	2.96	7.7	2.97	7.6	2.99
	-13.7	-15.0	8.8	2.57	8.8	2.84	8.8	2.99	8.8	3.01	8.8	3.02	8.8	3.01
	-11.8	-13.0	9.5	2.64	9.5	2.94	9.5	3.03	9.5	3.06	9.5	3.04	9.5	3.06
	-9.8	-11.0	9.8	2.74	9.8	2.99	9.8	3.06	9.8	3.07	9.8	3.08	9.8	3.12
	-9.5	-10.0	10.5	2.83	10.5	3.03	10.5	3.10	10.5	3.10	10.5	3.15	10.4	3.17
	-8.5	-9.1	10.9	2.88	10.9	3.06	10.9	3.17	10.9	3.17	10.9	3.19	10.7	3.21
	-7.0	-7.6	11.3	2.93	11.3	3.11	11.3	3.21	11.3	3.21	11.3	3.24	11.3	3.24
	-5.0	-5.6	11.9	2.95	11.9	3.18	11.9	3.26	11.9	3.25	11.9	3.27	11.8	3.31
	-3.0	-3.7	12.3	3.00	12.3	3.22	12.2	3.29	12.3	3.29	12.3	3.34	12.2	3.37
	0.0	-0.7	13	3.07	13	3.26	13	3.36	13	3.35	13	3.40	12.2	3.30
	3.0	2.2	13.7	3.10	13.7	3.3	13.7	3.40	13.6	3.34	13.1	3.33	12.2	3.25
	5.0	4.1	14.2	3.15	14.2	3.36	14	3.34	13.6	3.28	13.1	3.28	12.2	3.16
	7.0	6.0	14.7	3.18	14.7	3.42	14	3.30	13.6	3.23	13.1	3.19	12.2	2.99
	9.0	7.9	15.2	3.24	14.7	3.35	14	3.20	13.6	3.14	13.1	3.02	12.2	2.94
11.0	9.8	15.6	3.30	14.7	3.3	14	3.04	13.6	2.98	13.1	2.97	12.2	2.92	
13.0	11.8	15.8	3.23	14.7	3.21	14	2.99	13.6	2.94	13.1	2.93	12.2	2.86	
15.0	13.7	15.8	3.19	14.7	3.04	14	2.96	13.6	2.90	13.1	2.89	12.2	2.75	
90%	-19.8	-20.0	5.6	2.57	5.6	2.83	5.6	2.85	5.6	2.95	5.6	2.94	5.6	2.99
	-18.8	-19.0	6.8	2.64	6.7	2.93	6.7	2.90	6.7	3.00	6.7	2.98	6.7	3.04
	-16.7	-17.0	7.7	2.74	7.7	2.98	7.7	2.94	7.7	3.04	7.7	3.01	7.6	3.10
	-13.7	-15.0	8.8	2.83	8.8	3.03	8.8	2.96	8.8	3.07	8.8	3.06	8.8	3.14
	-11.8	-13.0	9.5	2.88	9.5	3.05	9.5	3.02	9.5	3.08	9.5	3.12	9.5	3.19
	-9.8	-11.0	9.8	2.93	9.8	3.1	9.8	3.07	9.8	3.15	9.8	3.16	9.8	3.22

GMV5 Home DC Inverter Multi VRF Units

	-9.5	-10.0	10.5	2.95	10.5	3.17	10.5	3.12	10.5	3.19	10.5	3.21	10.4	3.29
	-8.5	-9.1	10.9	3.00	10.9	3.21	10.9	3.16	10.9	3.24	10.9	3.24	10.7	3.34
	-7.0	-7.6	11.3	3.07	11.3	3.26	11.3	3.19	11.3	3.27	11.3	3.30	10.7	3.28
	-5.0	-5.6	11.9	3.10	11.9	3.29	11.9	3.26	11.9	3.33	11.9	3.36	10.7	3.23
	-3.0	-3.7	12.3	3.14	12.3	3.35	12.3	3.31	12.3	3.33	11.9	3.29	10.7	3.14
	0.0	-0.7	13	3.18	13	3.41	12.6	3.24	12.3	3.26	11.9	3.25	10.7	2.98
	3.0	2.2	13.7	3.24	13.7	3.34	12.6	3.20	12.3	3.21	11.9	3.15	10.7	2.92
	5.0	4.1	13.9	3.30	13.7	3.3	12.6	3.11	12.3	3.12	11.9	2.99	10.7	2.90
	7.0	6.0	14.2	3.23	13.7	3.2	12.6	2.95	12.3	2.96	11.9	2.94	10.7	2.84
	9.0	7.9	14.2	3.18	13.7	3.03	12.6	2.90	12.3	2.91	11.9	2.91	10.7	2.74
	11.0	9.8	14.2	3.09	13.7	2.98	12.6	2.87	12.3	2.88	11.9	2.86	10.7	2.62
	13.0	11.8	14.2	2.93	13.7	2.96	12.6	2.82	12.3	2.83	11.9	2.75	10.7	2.53
	15.0	13.7	14.2	2.88	13.7	2.9	12.6	2.72	12.3	2.73	11.9	2.64	10.7	2.44
80%	-19.8	-20.0	5.6	2.83	5.6	2.97	5.6	2.94	5.6	2.97	5.6	3.03	5.6	3.09
	-18.8	-19.0	6.8	2.88	6.7	3.02	6.7	2.96	6.7	3.02	6.7	3.09	6.7	3.14
	-16.7	-17.0	7.7	2.92	7.7	3.04	7.7	3.02	7.7	3.08	7.7	3.13	7.6	3.18
	-13.7	-15.0	8.8	2.95	8.8	3.09	8.8	3.07	8.8	3.12	8.8	3.17	8.8	3.22
	-11.8	-13.0	9.5	3.00	9.5	3.16	9.5	3.12	9.5	3.17	9.5	3.21	9.5	3.28
	-9.8	-11.0	9.8	3.06	9.8	3.2	9.8	3.16	9.8	3.20	9.8	3.27	9.8	3.34
	-9.5	-10.0	10.5	3.09	10.5	3.25	10.5	3.19	10.5	3.26	10.5	3.33	9.8	3.27
	-8.5	-9.1	10.9	3.14	10.9	3.28	10.9	3.26	10.9	3.32	10.5	3.26	9.8	3.22
	-7.0	-7.6	11.3	3.17	11.3	3.34	11.3	3.31	10.9	3.25	10.5	3.21	9.8	3.13
	-5.0	-5.6	11.9	3.23	11.9	3.4	11.3	3.24	10.9	3.21	10.5	3.12	9.8	2.97
	-3.0	-3.7	12.3	3.29	11.9	3.33	11.3	3.20	10.9	3.12	10.5	2.96	9.8	2.92
	0.0	-0.7	13	3.22	11.9	3.29	11.3	3.11	10.9	2.96	10.5	2.91	9.8	2.89
	3.0	2.2	13	3.18	11.9	3.2	11.3	2.95	10.9	2.90	10.5	2.88	9.8	2.84
	5.0	4.1	13	3.09	11.9	3.03	11.3	2.90	10.9	2.88	10.5	2.83	9.8	2.74
	7.0	6.0	13	2.93	11.9	2.97	11.3	2.87	10.9	2.83	10.5	2.73	9.8	2.62
	9.0	7.9	13	2.88	11.9	2.95	11.3	2.82	10.9	2.73	10.5	2.61	9.8	2.52
11.0	9.8	13	2.85	11.9	2.9	11.3	2.72	10.9	2.61	10.5	2.52	9.8	2.43	
13.0	11.8	13	2.80	11.9	2.79	11.3	2.60	10.9	2.51	10.5	2.43	9.8	2.37	
15.0	13.7	13	2.70	11.9	2.67	11.3	2.51	10.9	2.43	10.5	2.36	9.8	2.27	

GMV-S140WL/A-S

TC—represents capacity of outdoor unit; PI—represents power of outdoor unit														
Capacity collocation rate of indoor and outdoor units	Outdoor ambiet temperature		Indoor ambient temperature °C DB											
			16		18		20		21		22		24	
	°C DB	°C WB	TC	PI	TC	PI	TC	PI	TC	PI	TC	PI	TC	PI
100%	-19.8	-20.0	6.6	2.93	6.6	3.09	6.6	3.39	6.6	3.49	6.6	3.50	6.5	3.59
	-18.8	-19.0	7.9	3.02	7.9	3.22	7.9	3.52	7.9	3.62	7.9	3.62	7.8	3.65
	-16.7	-17.0	9.1	3.08	9.1	3.30	9.1	3.64	9.1	3.67	9.1	3.68	9.0	3.71

GMV5 Home DC Inverter Multi VRF Units

	-13.7	-15.0	10.4	3.20	10.4	3.42	10.4	3.70	10.4	3.74	10.4	3.74	10.4	3.74
	-11.8	-13.0	11.2	3.28	11.2	3.54	11.1	3.76	11.2	3.80	11.2	3.77	11.1	3.81
	-9.8	-11.0	11.6	3.40	11.6	3.60	11.6	3.80	11.6	3.83	11.6	3.84	11.6	3.89
	-9.5	-10.0	12.3	3.52	12.3	3.66	12.4	3.86	12.3	3.86	12.3	3.92	12.3	3.94
	-8.5	-9.1	12.8	3.58	12.8	3.68	12.8	3.94	12.8	3.94	12.8	3.97	12.6	3.99
	-7.0	-7.6	13.4	3.64	13.4	3.74	13.4	3.99	13.4	3.99	13.4	4.03	13.3	4.03
	-5.0	-5.6	14.0	3.66	14.0	3.84	14.0	4.05	14.0	4.05	14.0	4.07	13.9	4.11
	-3.0	-3.7	14.4	3.73	14.4	3.88	14.4	4.09	14.4	4.09	14.4	4.14	14.3	4.18
	0.0	-0.7	15.3	3.82	15.3	3.94	15.3	4.17	15.3	4.16	15.3	4.22	14.3	4.10
	3.0	2.2	16.2	3.87	16.2	3.98	16.2	4.24	15.9	4.15	15.4	4.13	14.3	4.04
	5.0	4.1	16.7	3.92	16.7	4.05	16.5	4.15	15.9	4.07	15.4	4.08	14.3	3.93
	7.0	6.0	17.3	3.96	17.2	4.12	16.5	4.10	15.9	4.02	15.4	3.97	14.3	3.71
	9.0	7.9	17.9	4.03	17.2	4.04	16.5	3.99	15.9	3.91	15.4	3.75	14.3	3.65
	11.0	9.8	18.4	4.10	17.2	3.99	16.5	3.77	15.9	3.69	15.4	3.68	14.3	3.62
	13.0	11.8	18.6	4.02	17.2	3.88	16.5	3.70	15.9	3.65	15.4	3.64	14.3	3.56
	15.0	13.7	18.6	3.97	17.2	3.66	16.5	3.67	15.9	3.60	15.4	3.59	14.3	3.43
90%	-19.8	-20.0	6.6	3.19	6.6	3.41	6.6	3.54	6.6	3.66	6.6	3.65	6.5	3.71
	-18.8	-19.0	7.9	3.28	7.9	3.53	7.9	3.60	7.9	3.72	7.9	3.70	7.8	3.77
	-16.7	-17.0	9.1	3.40	9.1	3.59	9.1	3.65	9.1	3.77	9.1	3.73	9.0	3.87
	-13.7	-15.0	10.4	3.52	10.4	3.65	10.4	3.68	10.4	3.81	10.4	3.80	10.4	3.91
	-11.8	-13.0	11.2	3.58	11.2	3.67	11.2	3.74	11.2	3.84	11.2	3.88	11.1	3.97
	-9.8	-11.0	11.6	3.63	11.6	3.74	11.6	3.83	11.6	3.92	11.6	3.93	11.6	4.01
	-9.5	-10.0	12.3	3.66	12.3	3.83	12.3	3.88	12.3	3.97	12.3	3.99	12.3	4.08
	-8.5	-9.1	12.8	3.72	12.8	3.88	12.8	3.93	12.8	4.03	12.8	4.03	12.6	4.15
	-7.0	-7.6	13.4	3.81	13.4	3.93	13.4	3.97	13.4	4.07	13.4	4.10	12.6	4.07
	-5.0	-5.6	14.0	3.86	14.0	3.97	14.0	4.05	14.0	4.13	14.0	4.17	12.6	4.02
	-3.0	-3.7	14.4	3.91	14.4	4.04	14.4	4.12	14.4	4.13	14.0	4.09	12.6	3.91
	0.0	-0.7	15.3	3.95	15.3	4.11	14.9	4.03	14.4	4.05	14.0	4.04	12.6	3.69
	3.0	2.2	16.2	4.03	16.2	4.03	14.9	3.98	14.4	4.00	14.0	3.93	12.6	3.63
	5.0	4.1	16.4	4.09	16.2	3.98	14.9	3.87	14.4	3.89	14.0	3.71	12.6	3.60
	7.0	6.0	16.7	4.01	16.2	3.87	14.9	3.66	14.4	3.67	14.0	3.65	12.6	3.54
	9.0	7.9	16.7	3.96	16.2	3.65	14.9	3.60	14.4	3.61	14.0	3.62	12.6	3.40
11.0	9.8	16.7	3.85	16.2	3.59	14.9	3.57	14.4	3.58	14.0	3.55	12.6	3.26	
13.0	11.8	16.7	3.64	16.2	3.56	14.9	3.50	14.4	3.52	14.0	3.42	12.6	3.15	
15.0	13.7	16.7	3.58	16.2	3.50	14.9	3.37	14.4	3.39	14.0	3.28	12.6	3.04	
80%	-19.8	-20.0	6.6	3.51	6.6	3.58	6.6	3.65	6.6	3.69	6.6	3.75	6.5	3.86
	-18.8	-19.0	7.9	3.57	7.9	3.64	7.9	3.68	7.9	3.75	7.9	3.85	7.8	3.90
	-16.7	-17.0	9.1	3.63	9.1	3.66	9.1	3.74	9.1	3.84	9.1	3.89	9.0	3.96
	-13.7	-15.0	10.4	3.66	10.4	3.73	10.4	3.83	10.4	3.89	10.4	3.95	10.4	4.00
	-11.8	-13.0	11.2	3.72	11.2	3.82	11.2	3.88	11.2	3.94	11.2	3.99	11.1	4.07
	-9.8	-11.0	11.6	3.81	11.6	3.87	11.6	3.93	11.6	3.98	11.6	4.06	11.6	4.14
	-9.5	-10.0	12.3	3.86	12.3	3.92	12.3	3.97	12.3	4.06	12.3	4.13	11.6	4.06
	-8.5	-9.1	12.8	3.91	12.8	3.96	12.8	4.05	12.8	4.13	12.3	4.05	11.6	4.01
	-7.0	-7.6	13.4	3.95	13.4	4.03	13.4	4.12	12.8	4.04	12.3	4.00	11.6	3.90
	-5.0	-5.6	14.0	4.02	14.0	4.10	13.4	4.03	12.8	3.99	12.3	3.89	11.6	3.68

GMV5 Home DC Inverter Multi VRF Units

	-3.0	-3.7	14.4	4.09	14.0	4.02	13.4	3.98	12.8	3.88	12.3	3.67	11.6	3.62
	0.0	-0.7	15.3	4.01	14.0	3.97	13.4	3.87	12.8	3.67	12.3	3.61	11.6	3.59
	3.0	2.2	15.3	3.96	14.0	3.86	13.4	3.66	12.8	3.61	12.3	3.58	11.6	3.53
	5.0	4.1	15.3	3.85	14.0	3.64	13.4	3.60	12.8	3.58	12.3	3.52	11.6	3.40
	7.0	6.0	15.3	3.64	14.0	3.58	13.4	3.57	12.8	3.51	12.3	3.39	11.6	3.25
	9.0	7.9	15.3	3.57	14.0	3.56	13.4	3.50	12.8	3.38	12.3	3.24	11.6	3.14
	11.0	9.8	15.3	3.55	14.0	3.49	13.4	3.37	12.8	3.24	12.3	3.13	11.6	3.04
	13.0	11.8	15.3	3.48	14.0	3.36	13.4	3.23	12.8	3.13	12.3	3.03	11.6	2.94
	15.0	13.7	15.3	3.35	14.0	3.22	13.4	3.12	12.8	3.02	12.3	2.93	11.6	2.81

GMV-S160WL/A-S

TC—represents capacity of outdoor unit; PI—represents power of outdoor unit														
Capacity collocation rate of indoor and outdoor units	Outdoor ambient temperature		Indoor ambient temperature °C DB											
			16		18		20		21		22		24	
	°C DB	°C WB	TC	PI	TC	PI	TC	PI	TC	PI	TC	PI	TC	PI
100%	-19.8	-20.0	7.5	3.34	7.4	3.52	7.4	3.86	7.4	3.97	7.4	3.98	7.4	4.09
	-18.8	-19.0	8.9	3.42	8.8	3.66	8.8	4.00	8.8	4.12	8.8	4.13	8.8	4.17
	-16.7	-17.0	10.2	3.50	10.2	3.75	10.2	4.15	10.2	4.18	10.2	4.19	10.1	4.22
	-13.7	-15.0	11.7	3.64	11.7	3.90	11.7	4.22	11.7	4.26	11.7	4.26	11.7	4.26
	-11.8	-13.0	12.6	3.73	12.6	4.03	12.5	4.28	12.6	4.32	12.6	4.29	12.5	4.33
	-9.8	-11.0	12.9	3.88	12.9	4.11	12.9	4.32	12.9	4.36	12.9	4.37	12.9	4.43
	-9.5	-10.0	13.9	4.01	13.9	4.17	13.9	4.39	13.9	4.39	13.9	4.46	13.8	4.48
	-8.5	-9.1	14.4	4.08	14.4	4.19	14.4	4.48	14.4	4.48	14.4	4.52	14.2	4.54
	-7.0	-7.6	14.9	4.15	14.9	4.27	15.0	4.54	14.9	4.54	14.9	4.58	14.9	4.59
	-5.0	-5.6	15.7	4.18	15.7	4.36	15.7	4.61	15.7	4.61	15.7	4.63	15.6	4.68
	-3.0	-3.7	16.2	4.24	16.2	4.42	16.2	4.66	16.2	4.66	16.2	4.71	16.2	4.75
	0.0	-0.7	17.2	4.34	17.2	4.48	17.2	4.74	17.2	4.73	17.2	4.80	16.2	4.67
	3.0	2.2	18.2	4.40	18.2	4.52	18.1	4.82	17.9	4.72	17.3	4.70	16.2	4.60
	5.0	4.1	18.8	4.45	18.8	4.61	18.5	4.72	17.9	4.63	17.3	4.64	16.2	4.47
	7.0	6.0	19.4	4.50	19.3	4.69	18.5	4.67	17.9	4.57	17.3	4.51	16.2	4.23
	9.0	7.9	20.1	4.59	19.3	4.60	18.5	4.53	17.9	4.44	17.3	4.27	16.2	4.17
11.0	9.8	20.7	4.67	19.3	4.53	18.5	4.29	17.9	4.20	17.3	4.19	16.2	4.13	
13.0	11.8	20.8	4.57	19.3	4.41	18.5	4.22	17.9	4.16	17.3	4.15	16.2	4.05	
15.0	13.7	20.8	4.51	19.3	4.18	18.5	4.18	17.9	4.10	17.3	4.09	16.2	3.90	
90%	-19.8	-20.0	7.5	3.64	7.4	3.89	7.4	4.03	7.4	4.17	7.4	4.16	7.4	4.23
	-18.8	-19.0	8.9	3.72	8.8	4.02	8.8	4.10	8.8	4.24	8.8	4.22	8.8	4.30
	-16.7	-17.0	10.2	3.87	10.2	4.09	10.2	4.16	10.2	4.30	10.2	4.25	10.1	4.40
	-13.7	-15.0	11.7	4.01	11.7	4.16	11.7	4.19	11.7	4.34	11.7	4.32	11.7	4.45
	-11.8	-13.0	12.6	4.08	12.6	4.18	12.6	4.26	12.6	4.37	12.6	4.42	12.5	4.51
	-9.8	-11.0	12.9	4.14	12.9	4.25	12.9	4.36	12.9	4.46	12.9	4.47	12.9	4.56
	-9.5	-10.0	13.9	4.18	13.9	4.35	13.9	4.42	13.9	4.52	13.9	4.54	13.8	4.65
-8.5	-9.1	14.4	4.24	14.4	4.41	14.4	4.47	14.4	4.58	14.4	4.59	14.2	4.72	

GMV5 Home DC Inverter Multi VRF Units

	-7.0	-7.6	14.9	4.33	14.9	4.46	14.9	4.52	14.9	4.63	14.9	4.67	14.2	4.63
	-5.0	-5.6	15.7	4.39	15.7	4.51	15.7	4.61	15.7	4.70	15.7	4.75	14.2	4.57
	-3.0	-3.7	16.2	4.45	16.2	4.60	16.2	4.68	16.2	4.70	15.7	4.66	14.2	4.44
	0.0	-0.7	17.2	4.49	17.2	4.68	16.7	4.59	16.2	4.61	15.7	4.60	14.2	4.20
	3.0	2.2	18.2	4.58	18.2	4.59	16.7	4.53	16.2	4.55	15.7	4.46	14.2	4.14
	5.0	4.1	18.3	4.66	18.2	4.52	16.7	4.41	16.2	4.42	15.7	4.22	14.2	4.10
	7.0	6.0	18.8	4.57	18.2	4.40	16.7	4.17	16.2	4.18	15.7	4.16	14.2	4.03
	9.0	7.9	18.8	4.50	18.2	4.17	16.7	4.10	16.2	4.12	15.7	4.13	14.2	3.88
	11.0	9.8	18.8	4.38	18.2	4.09	16.7	4.07	16.2	4.08	15.7	4.05	14.2	3.71
	13.0	11.8	18.8	4.15	18.2	4.06	16.7	3.99	16.2	4.00	15.7	3.90	14.2	3.58
	15.0	13.7	18.8	4.08	18.2	3.98	16.7	3.84	16.2	3.86	15.7	3.73	14.2	3.46
80%	-19.8	-20.0	7.5	4.00	7.4	4.08	7.4	4.16	7.4	4.20	7.4	4.28	7.4	4.39
	-18.8	-19.0	8.9	4.07	8.8	4.15	8.8	4.19	8.8	4.27	8.8	4.38	8.8	4.44
	-16.7	-17.0	10.2	4.14	10.2	4.18	10.2	4.26	10.2	4.37	10.2	4.43	10.1	4.50
	-13.7	-15.0	11.7	4.17	11.7	4.24	11.7	4.36	11.7	4.43	11.7	4.49	11.7	4.55
	-11.8	-13.0	12.6	4.23	12.6	4.34	12.6	4.42	12.6	4.48	12.6	4.54	12.5	4.64
	-9.8	-11.0	12.9	4.33	12.9	4.40	12.9	4.47	12.9	4.53	12.9	4.62	12.9	4.71
	-9.5	-10.0	13.9	4.39	13.9	4.45	13.9	4.52	13.9	4.62	13.9	4.70	12.9	4.62
	-8.5	-9.1	14.4	4.44	14.4	4.50	14.4	4.61	14.4	4.69	13.9	4.61	12.9	4.56
	-7.0	-7.6	14.9	4.49	14.9	4.59	14.9	4.68	14.4	4.60	13.9	4.55	12.9	4.43
	-5.0	-5.6	15.7	4.58	15.7	4.67	14.9	4.59	14.4	4.54	13.9	4.42	12.9	4.19
	-3.0	-3.7	16.2	4.66	15.7	4.57	14.9	4.53	14.4	4.42	13.9	4.18	12.9	4.13
	0.0	-0.7	17.2	4.56	15.7	4.51	14.9	4.41	14.4	4.18	13.9	4.12	12.9	4.09
	3.0	2.2	17.2	4.50	15.7	4.39	14.9	4.17	14.4	4.11	13.9	4.08	12.9	4.02
	5.0	4.1	17.2	4.38	15.7	4.16	14.9	4.10	14.4	4.08	13.9	4.00	12.9	3.87
	7.0	6.0	17.2	4.15	15.7	4.08	14.9	4.07	14.4	4.00	13.9	3.86	12.9	3.70
	9.0	7.9	17.2	4.07	15.7	4.05	14.9	3.99	14.4	3.85	13.9	3.69	12.9	3.57
11.0	9.8	17.2	4.04	15.7	3.97	14.9	3.84	14.4	3.68	13.9	3.56	12.9	3.45	
13.0	11.8	17.2	3.96	15.7	3.83	14.9	3.67	14.4	3.56	13.9	3.44	12.9	3.35	
15.0	13.7	17.2	3.82	15.7	3.67	14.9	3.55	14.4	3.43	13.9	3.34	12.9	3.20	

GMV-S224W/A-X

TC—represents capacity of outdoor unit; PI—represents power of outdoor unit														
Capacity collocation rate of indoor and outdoor units	Outdoor ambient temperature		Indoor ambient temperature °C DB											
			16		18		20		21		22		24	
	°C DB	°C WB	TC	PI	TC	PI	TC	PI	TC	PI	TC	PI	TC	PI
100%	-19.8	-20.0	16.0	5.27	15.9	5.49	15.9	5.72	15.8	5.83	15.8	5.94	15.7	6.16
	-18.8	-19.0	16.2	5.34	16.2	5.56	16.1	5.78	16.1	5.89	16.0	6.00	16.0	6.22
	-16.7	-17.0	16.8	5.49	16.7	5.70	16.7	5.91	16.7	6.02	16.7	6.12	16.7	6.33
	-13.7	-15.0	17.5	5.65	17.5	5.85	17.5	6.06	17.4	6.16	17.4	6.26	17.3	6.46
	-11.8	-13.0	18.3	5.82	18.3	6.00	18.2	6.20	18.2	6.30	18.2	6.17	18.1	6.59
	-9.8	-11.0	19.1	5.97	19.0	6.16	19.0	6.34	19.0	6.44	19.0	6.53	19.0	6.71

GMV5 Home DC Inverter Multi VRF Units

	-9.5	-10.0	19.6	6.06	19.5	6.24	19.5	6.42	19.4	6.51	19.4	6.60	19.4	6.78
	-8.5	-9.1	20.0	6.12	20.0	6.30	19.9	6.48	19.9	6.57	19.8	6.66	19.8	6.83
	-7.0	-7.6	20.7	6.24	20.7	6.42	20.6	6.58	20.6	6.67	20.6	6.76	20.6	6.93
	-5.0	-5.6	21.8	6.40	21.7	6.56	21.7	6.73	21.7	6.81	21.7	6.88	21.7	7.05
	-3.0	-3.7	22.9	6.55	22.9	6.70	22.8	6.85	22.8	6.93	22.8	7.01	21.8	6.71
	0.0	-0.7	24.7	6.76	24.7	6.90	24.6	7.04	24.2	6.93	23.4	6.64	21.8	6.10
	3.0	2.2	26.7	6.95	26.6	7.08	25.0	6.55	24.2	6.30	23.4	6.05	21.8	5.55
	5.0	4.1	28.0	7.08	26.6	6.65	25.0	6.16	24.2	5.93	23.4	5.69	21.8	5.24
	7.0	6.0	28.2	6.72	26.6	6.25	25.0	5.80	24.2	5.58	23.4	5.36	21.8	4.93
	9.0	7.9	28.2	6.31	26.6	5.88	25.0	5.46	24.2	5.26	23.4	5.05	21.8	4.66
	11.0	9.8	28.2	5.94	26.6	5.54	25.0	5.15	24.2	4.96	23.4	4.77	21.8	4.40
	13.0	11.8	28.2	5.58	26.6	5.21	25.0	4.85	24.2	4.67	23.4	4.50	21.8	4.15
	15.0	13.7	28.2	5.27	26.6	4.92	25.0	4.58	24.2	4.41	23.4	4.25	21.8	3.93
90%	-19.8	-20.0	15.9	5.66	15.8	5.86	15.8	6.06	15.7	6.16	15.7	6.27	15.7	6.46
	-18.8	-19.0	16.1	5.72	16.1	5.93	16.0	6.12	16.0	6.22	16.0	6.32	16.0	6.52
	-16.7	-17.0	16.7	5.87	16.7	6.06	16.7	6.24	16.7	6.34	16.6	6.43	16.6	6.62
	-13.7	-15.0	17.5	6.01	17.4	6.19	17.4	6.37	17.3	6.40	17.3	6.55	17.3	6.73
	-11.8	-13.0	18.2	6.15	18.2	6.33	18.1	6.50	18.1	6.59	18.1	6.67	18.0	6.85
	-9.8	-11.0	19.0	6.30	19.0	6.46	19.0	6.63	19.0	6.72	19.0	6.80	18.9	6.97
	-9.5	-10.0	19.5	6.37	19.4	6.54	19.4	6.70	19.4	6.78	19.4	6.86	19.4	7.02
	-8.5	-9.1	19.9	6.44	19.9	6.60	19.8	6.76	19.8	6.83	19.8	6.91	19.6	6.98
	-7.0	-7.6	20.6	6.55	20.6	6.70	20.6	6.85	20.6	6.93	20.6	7.01	19.6	6.67
	-5.0	-5.6	21.7	6.69	21.7	6.83	21.7	6.98	21.7	7.05	21.0	6.83	19.6	6.27
	-3.0	-3.7	22.8	6.82	22.8	6.20	22.5	6.98	21.7	6.70	21.0	6.43	19.6	5.91
	0.0	-0.7	24.7	7.01	24.0	6.09	22.5	6.33	21.7	6.09	21.0	5.85	19.6	5.37
	3.0	2.2	25.4	6.68	24.0	6.22	22.5	5.77	21.7	5.55	21.0	5.33	19.6	4.91
	5.0	4.1	25.4	6.28	24.0	5.85	22.5	5.44	21.7	5.23	21.0	5.03	19.6	4.63
	7.0	6.0	25.4	5.91	24.0	5.51	22.5	5.12	21.7	4.93	21.0	4.75	19.6	4.38
	9.0	7.9	25.4	5.57	24.0	5.19	22.5	4.83	21.7	4.66	21.0	4.48	19.6	4.14
11.0	9.8	25.4	5.24	24.0	4.90	22.5	4.56	21.7	4.40	21.0	4.23	19.6	3.92	
13.0	11.8	25.4	4.93	24.0	4.62	22.5	4.30	21.7	4.15	21.0	4.00	19.6	3.70	
15.0	13.7	25.4	4.66	24.0	4.36	22.5	4.08	21.7	3.92	21.0	3.79	19.6	3.51	
80%	-19.8	-20.0	15.8	6.06	15.7	6.23	15.7	6.41	15.7	6.50	15.6	6.59	15.6	6.76
	-18.8	-19.0	16.0	6.11	16.0	6.29	16.0	6.46	16.0	6.55	16.0	6.64	15.9	6.82
	-16.7	-17.0	16.7	6.24	16.6	6.40	16.6	6.58	16.6	6.66	16.6	6.74	16.5	6.91
	-13.7	-15.0	17.4	6.37	17.3	6.52	17.3	6.69	17.3	6.76	17.2	6.85	17.2	7.01
	-11.8	-13.0	18.1	6.49	18.1	6.65	18.0	6.80	18.0	6.88	18.0	6.96	17.5	6.77
	-9.8	-11.0	19.0	6.62	19.0	6.77	18.9	6.92	18.9	6.99	18.7	6.98	17.5	6.40
	-9.5	-10.0	19.4	6.69	19.4	6.83	19.4	6.98	19.4	7.05	18.7	6.77	17.5	6.21
	-8.5	-9.1	19.8	6.75	19.8	6.89	19.8	7.03	19.4	6.88	18.7	6.59	17.5	6.04
	-7.0	-7.6	20.6	6.85	20.6	6.98	20.0	6.83	19.4	6.56	18.7	6.30	17.5	5.80
	-5.0	-5.6	21.7	6.21	21.3	6.93	20.0	6.42	19.4	6.17	18.7	5.92	17.5	5.44
	-3.0	-3.7	22.5	6.25	21.3	6.52	20.0	6.04	19.4	5.84	18.7	5.58	17.5	5.14
	0.0	-0.7	22.5	6.36	21.3	5.92	20.0	5.50	19.4	5.30	18.7	5.08	17.5	4.69
3.0	2.2	22.5	5.79	21.3	5.40	20.0	5.02	19.4	4.84	18.7	4.66	17.5	4.29	

GMV5 Home DC Inverter Multi VRF Units

	5.0	4.1	22.5	5.45	21.3	5.09	20.0	4.74	19.4	4.56	18.7	4.40	17.5	4.06
	7.0	6.0	22.5	5.14	21.3	4.81	20.0	4.47	19.4	4.32	18.7	4.16	17.5	3.84
	9.0	7.9	22.5	4.85	21.3	4.53	20.0	4.25	19.4	4.08	18.7	3.93	17.5	3.64
	11.0	9.8	22.5	4.58	21.3	4.29	20.0	4.00	19.4	3.86	18.7	3.72	17.5	3.45
	13.0	11.8	22.5	4.32	21.3	4.05	20.0	3.78	19.4	3.65	18.7	3.52	17.5	3.26
	15.0	13.7	22.5	4.08	21.3	3.83	20.0	3.59	19.4	3.46	18.7	3.34	17.5	3.10

GMV-S280W/A-X

TC—represents capacity of outdoor unit; PI—represents power of outdoor unit

Capacity collocation rate of indoor and outdoor units	Outdoor ambient temperature		Indoor ambient temperature °C DB											
			16		18		20		21		22		24	
	°C	DB	TC	PI	TC	PI	TC	PI	TC	PI	TC	PI	TC	PI
			kW	kW	kW	kW	kW	kW	kW	kW	kW	kW	kW	kW
100%	-19.8	-20.0	20.1	6.91	20.0	7.19	20.0	7.49	19.9	7.64	19.9	7.78	19.8	8.07
	-18.8	-19.0	20.4	7.00	20.4	7.28	20.3	7.57	20.3	7.72	20.2	7.87	20.2	8.15
	-16.7	-17.0	21.2	7.19	21.1	7.47	21.1	7.75	21.1	7.89	21.0	8.02	21.0	8.30
	-13.7	-15.0	22.1	7.40	22.0	7.67	22.0	7.94	21.9	8.07	21.9	8.20	21.8	8.47
	-11.8	-13.0	23.0	7.62	23.0	7.87	22.9	8.12	22.9	8.25	22.9	8.08	22.8	8.64
	-9.8	-11.0	24.1	7.83	24.0	8.07	24.0	8.31	24.0	8.44	23.9	8.56	23.9	8.79
	-9.5	-10.0	24.7	7.94	24.6	8.17	24.6	8.41	24.5	8.53	24.5	8.65	24.4	8.88
	-8.5	-9.1	25.2	8.02	25.2	8.26	25.1	8.49	25.1	8.61	25.0	8.72	25.0	8.95
	-7.0	-7.6	26.1	8.18	26.1	8.41	26.0	8.63	26.0	8.74	26.0	8.85	25.9	9.08
	-5.0	-5.6	27.5	8.39	27.4	8.60	27.4	8.81	27.3	8.92	27.3	9.02	27.3	9.24
	-3.0	-3.7	28.8	8.58	28.8	8.77	28.7	8.98	28.7	9.08	28.7	9.18	27.5	8.79
	0.0	-0.7	31.1	8.86	31.1	9.04	31.0	9.23	30.5	9.08	29.5	8.70	27.5	7.99
	3.0	2.2	33.6	9.11	33.5	9.28	31.5	8.59	30.5	8.25	29.5	7.93	27.5	7.27
	5.0	4.1	35.3	9.28	33.5	8.71	31.5	8.07	30.5	7.77	29.5	7.46	27.5	6.86
	7.0	6.0	35.5	8.80	33.5	8.19	31.5	7.60	30.5	7.31	29.5	7.03	27.5	6.46
	9.0	7.9	35.5	8.27	33.5	7.71	31.5	7.16	30.5	6.89	29.5	6.62	27.5	6.10
11.0	9.8	35.5	7.79	33.5	7.26	31.5	6.75	30.5	6.49	29.5	6.25	27.5	5.76	
13.0	11.8	35.5	7.31	33.5	6.83	31.5	6.36	30.5	6.12	29.5	5.89	27.5	5.44	
15.0	13.7	35.5	6.90	33.5	6.44	31.5	6.00	30.5	5.78	29.5	5.57	27.5	5.15	
90%	-19.8	-20.0	20.0	7.42	19.9	7.68	19.9	7.95	19.8	8.07	19.8	8.21	19.8	8.47
	-18.8	-19.0	20.3	7.50	20.3	7.77	20.2	8.02	20.2	8.15	20.2	8.28	20.1	8.54
	-16.7	-17.0	21.1	7.69	21.0	7.94	21.0	8.18	21.0	8.31	20.9	8.43	20.9	8.68
	-13.7	-15.0	22.0	7.88	21.9	8.11	21.9	8.35	21.8	8.39	21.8	8.59	21.8	8.82
	-11.8	-13.0	22.9	8.06	22.9	8.29	22.8	8.52	22.8	8.64	22.8	8.74	22.7	8.97
	-9.8	-11.0	24.0	8.25	24.0	8.47	23.9	8.69	23.9	8.80	23.9	8.91	23.8	9.13
	-9.5	-10.0	24.6	8.35	24.5	8.57	24.5	8.77	24.4	8.88	24.4	8.99	24.4	9.20
	-8.5	-9.1	25.1	8.44	25.1	8.65	25.0	8.85	25.0	8.95	25.0	9.06	24.7	9.15
	-7.0	-7.6	26.0	8.58	26.0	8.77	25.9	8.98	25.9	9.08	25.9	9.18	24.7	8.73
	-5.0	-5.6	27.4	8.76	27.3	8.95	27.3	9.14	27.3	9.24	26.5	8.95	24.7	8.21
	-3.0	-3.7	28.7	8.93	28.7	8.12	28.4	9.15	27.4	8.78	26.5	8.43	24.7	7.74
0.0	-0.7	31.1	9.19	30.2	7.97	28.4	8.30	27.4	7.97	26.5	7.66	24.7	7.04	

GMV5 Home DC Inverter Multi VRF Units

	3.0	2.2	32.0	8.75	30.2	8.15	28.4	7.56	27.4	7.27	26.5	6.99	24.7	6.43
	5.0	4.1	32.0	8.23	30.2	7.67	28.4	7.13	27.4	6.85	26.5	6.59	24.7	6.07
	7.0	6.0	32.0	7.74	30.2	7.22	28.4	6.71	27.4	6.46	26.5	6.22	24.7	5.73
	9.0	7.9	32.0	7.29	30.2	6.80	28.4	6.33	27.4	6.10	26.5	5.87	24.7	5.42
	11.0	9.8	32.0	6.87	30.2	6.42	28.4	5.98	27.4	5.76	26.5	5.55	24.7	5.13
	13.0	11.8	32.0	6.46	30.2	6.05	28.4	5.64	27.4	5.44	26.5	5.24	24.7	4.85
	15.0	13.7	32.0	6.11	30.2	5.71	28.4	5.34	27.4	5.13	26.5	4.96	24.7	4.60
80%	-19.8	-20.0	19.9	7.94	19.8	8.16	19.8	8.40	19.8	8.52	19.7	8.64	19.7	8.86
	-18.8	-19.0	20.2	8.00	20.2	8.24	20.1	8.47	20.1	8.59	20.1	8.70	20.0	8.93
	-16.7	-17.0	21.0	8.17	20.9	8.39	20.9	8.62	20.9	8.72	20.9	8.83	20.8	9.05
	-13.7	-15.0	21.9	8.34	21.8	8.55	21.8	8.76	21.8	8.86	21.7	8.97	21.7	9.19
	-11.8	-13.0	22.8	8.51	22.8	8.71	22.7	8.91	22.7	9.01	22.7	9.12	22.0	8.87
	-9.8	-11.0	23.9	8.68	23.9	8.87	23.8	9.07	23.8	9.16	23.6	9.14	22.0	8.38
	-9.5	-10.0	24.5	8.76	24.4	8.95	24.4	9.14	24.4	9.24	23.6	8.87	22.0	8.13
	-8.5	-9.1	25.0	8.84	25.0	9.03	24.9	9.21	24.4	9.01	23.6	8.64	22.0	7.92
	-7.0	-7.6	25.9	8.97	25.9	9.15	25.2	8.95	24.4	8.60	23.6	8.25	22.0	7.60
	-5.0	-5.6	27.3	8.14	26.8	9.08	25.2	8.41	24.4	8.08	23.6	7.76	22.0	7.13
	-3.0	-3.7	28.4	8.19	26.8	8.55	25.2	7.92	24.4	7.65	23.6	7.31	22.0	6.73
	0.0	-0.7	28.4	8.33	26.8	7.76	25.2	7.20	24.4	6.94	23.6	6.66	22.0	6.14
	3.0	2.2	28.4	7.59	26.8	7.08	25.2	6.58	24.4	6.34	23.6	6.10	22.0	5.63
	5.0	4.1	28.4	7.15	26.8	6.67	25.2	6.21	24.4	5.98	23.6	5.76	22.0	5.32
	7.0	6.0	28.4	6.73	26.8	6.31	25.2	5.86	24.4	5.66	23.6	5.45	22.0	5.03
	9.0	7.9	28.4	6.36	26.8	5.94	25.2	5.57	24.4	5.34	23.6	5.15	22.0	4.77
	11.0	9.8	28.4	6.00	26.8	5.62	25.2	5.24	24.4	5.05	23.6	4.88	22.0	4.52
13.0	11.8	28.4	5.66	26.8	5.30	25.2	4.95	24.4	4.78	23.6	4.61	22.0	4.27	
15.0	13.7	28.4	5.35	26.8	5.02	25.2	4.70	24.4	4.53	23.6	4.37	22.0	4.07	

7.4 Revision coefficient of heating water capacity

GMV-S120WL/A-S、GMV-S140WL/A-S、GMV-S160WL/A-S

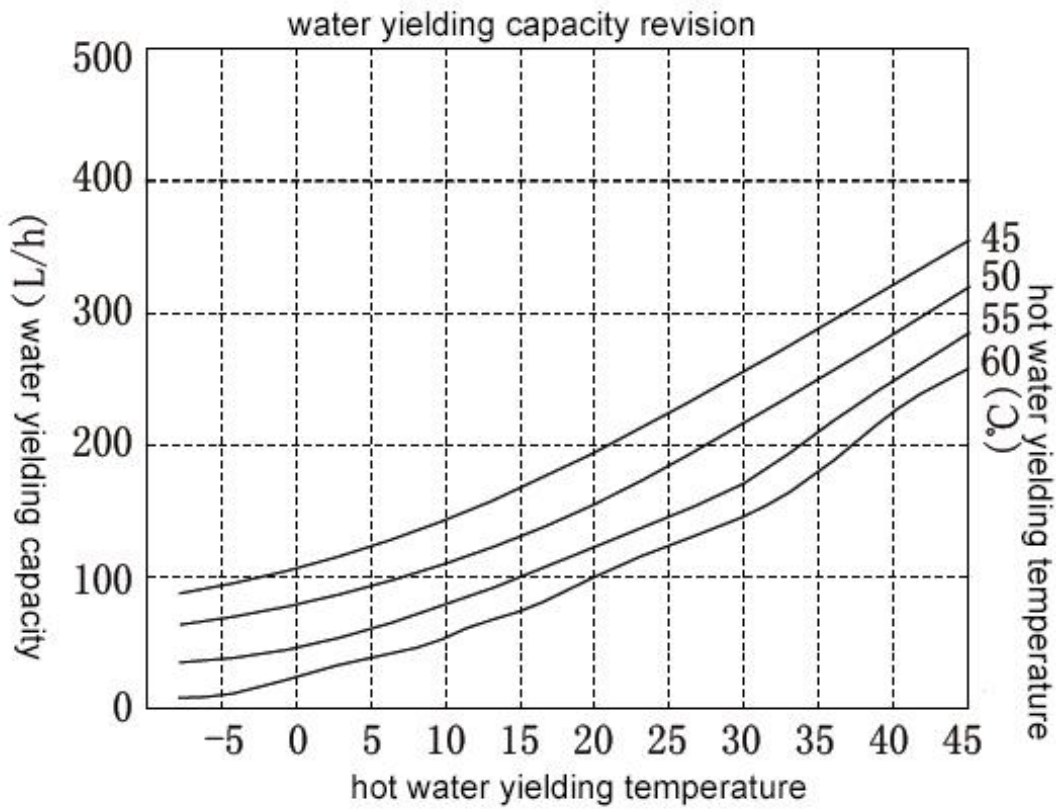

Outdoor unit: GMV-S224W/A-X

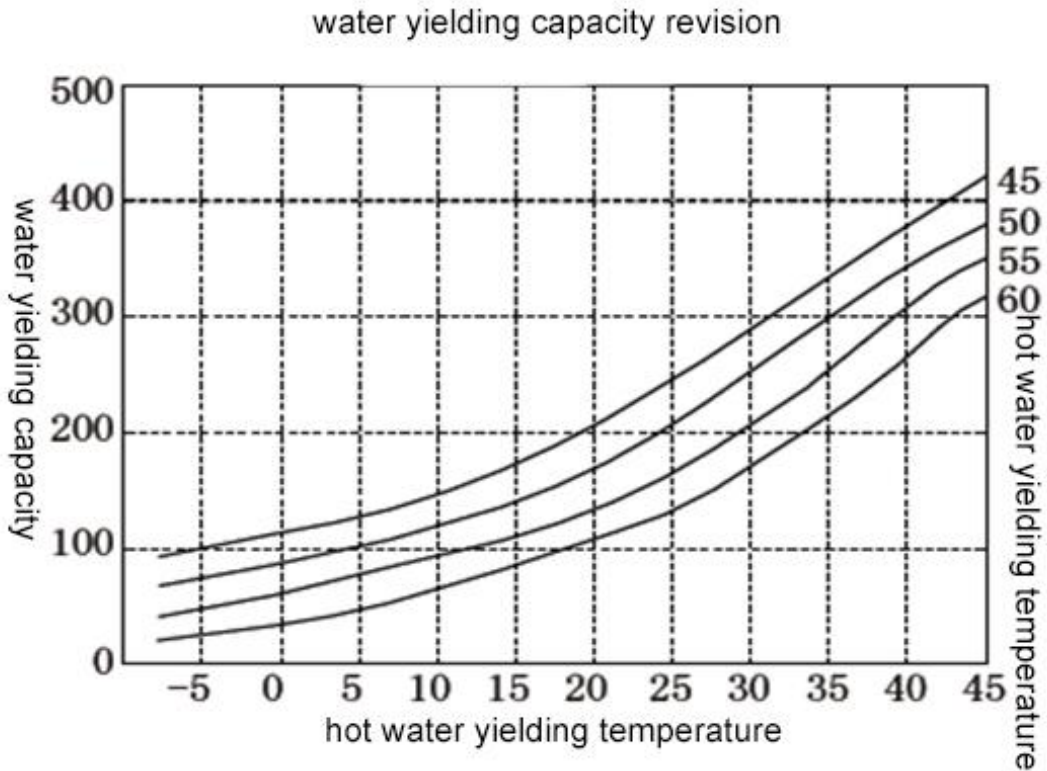

Outdoor unit: GMV-S280W/A-X

water yielding capacity revision

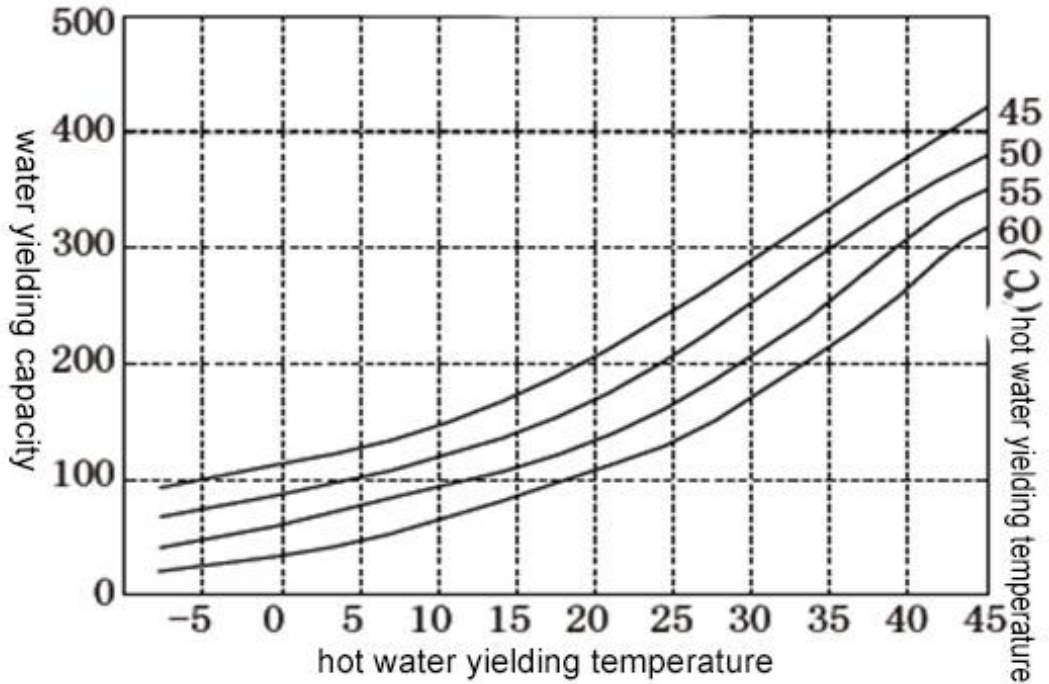

7.5 Revision of floor heating capacity

Outdoor unit: GMV-S120WL/A-S

Outdoor temperature		Water yielding temperature (°C)							
		30		35		40		45	
DB°C	WB°C	Capacity	Power	Capacity	Power	Capacity	Power	Capacity	Power
-9.8	-11	9.2	2.94	7.7	2.45	6.1	2.47	7.1	2.89
-9.5	-10	9.5	2.97	8.0	2.48	6.5	2.50	7.0	2.86
-8.5	-9.1	9.9	3.01	8.2	2.50	6.9	2.53	6.9	2.83
-5	-5.6	10.8	3.10	9.0	2.59	8.0	2.62	6.8	2.72
-3	-3.7	10.4	3.07	8.7	2.56	7.9	2.62	7.1	2.78
0	-0.7	9.9	3.02	8.3	2.52	7.7	2.61	7.5	2.87
3	2.2	11.9	3.15	9.9	2.63	9.6	2.92	9.1	3.04
5	4.1	13.2	3.24	11.0	2.70	10.8	3.13	10.2	3.16
7	6	14.5	3.33	12.1	2.77	12.0	3.34	11.3	3.27
9	7.9	14.6	3.39	13.5	2.83	12.8	3.16	12.3	3.32
15	13.7	14.6	3.42	14.6	2.87	14.6	3.17	14.6	3.44

Outdoor unit: GMV-S140WL/A-S

Outdoor temperature		Water yielding temperature (°C)							
		30		35		40		45	
DB°C	WB°C	Capacity	Power	Capacity	Power	Capacity	Power	Capacity	Power
-9.8	-11	10.8	3.52	9.0	2.94	7.1	2.96	8.2	3.47
-9.5	-10	11.1	3.56	9.3	2.97	7.6	3.00	8.2	3.43

GMV5 Home DC Inverter Multi VRF Units

-8.5	-9.1	11.5	3.60	9.6	3.00	8.0	3.03	8.1	3.38
-5	-5.6	12.6	3.71	10.5	3.10	9.4	3.14	7.9	3.26
-3	-3.7	12.2	3.68	10.1	3.06	9.2	3.13	8.2	3.33
0	-0.7	11.6	3.62	9.7	3.02	9.0	3.13	8.7	3.43
3	2.2	13.9	3.78	11.6	3.15	11.2	3.50	10.7	3.64
5	4.1	15.4	3.88	12.8	3.23	12.6	3.75	11.9	3.78
7	6	16.9	3.98	14.1	3.32	14.0	4.00	13.2	3.92
9	7.9	17.1	4.06	15.7	3.38	14.9	3.79	14.3	3.98
15	13.7	17.1	4.09	17.1	3.43	17.1	3.79	17.1	4.12

Outdoor unit: GMV-S160WL/A-S

Outdoor temperature		Water yielding temperature (°C)							
		30		35		40		45	
DB°C	WB°C	Capacity	Power	Capacity	Power	Capacity	Power	Capacity	Power
-9.8	-11	12.3	4.14	10.3	3.45	8.2	3.49	9.4	4.08
-9.5	-10	12.7	4.19	10.6	3.49	8.7	3.53	9.3	4.03
-8.5	-9.1	13.1	4.23	10.9	3.53	9.2	3.57	9.3	3.98
-5	-5.6	14.3	4.37	12.0	3.64	10.7	3.69	9.0	3.84
-3	-3.7	13.9	4.32	11.6	3.60	10.5	3.69	9.4	3.92
0	-0.7	13.3	4.26	11.1	3.55	10.3	3.68	10.0	4.04
3	2.2	15.8	4.44	13.2	3.70	12.7	4.12	12.2	4.28
5	4.1	17.6	4.56	14.6	3.80	14.4	4.41	13.6	4.45
7	6	19.3	4.69	16.1	3.91	16.0	4.71	15.1	4.61
9	7.9	19.5	4.78	17.9	3.98	17.1	4.46	16.4	4.68
15	13.7	19.5	4.81	19.5	4.04	19.5	4.46	19.5	4.85

Outdoor unit: GMV-S224W/A-X

TC—represents floor heating capacity of outdoor unit; PI—represents power of outdoor unit

Outdoor ambient temperature °C		Water yielding temperature °C							
		30		35		40		45	
°C DB	°C WB	TC	PI	TC	PI	TC	PI	TC	PI
		kW	kW	kW	kW	kW	kW	kW	kW
-7	-7.6	19.7	4.86	19.3	5.86	18.8	6.48	18.1	7.01
-5	-5.6	19.9	4.95	19.7	5.96	19.3	6.59	18.6	7.14
-3	-3.7	20.4	5.01	20.2	6.04	19.7	6.68	19.0	7.25
0	-0.7	21.3	4.71	20.8	5.89	20.4	6.71	19.5	7.94
3	2.2	22.4	4.40	22.4	5.49	22.4	6.26	20.2	7.14
5	4.1	22.4	4.23	22.4	5.29	22.4	6.03	22.4	6.88
7	6	22.4	4.07	22.4	5.09	22.4	5.80	22.4	6.61
9	7.9	22.4	3.92	22.4	4.90	22.4	5.59	22.4	6.37
11	9.8	22.4	3.78	22.4	4.72	22.4	5.38	22.4	6.14
13	11.8	22.4	3.64	22.4	4.55	22.4	5.19	22.4	5.92
15	13.7	22.4	3.52	22.4	4.40	22.4	5.02	22.4	5.73

GMV5 Home DC Inverter Multi VRF Units

Outdoor unit: GMV-S280W/A-X

TC—represents floor heating capacity of outdoor unit; PI—represents power of outdoor unit									
Outdoor ambient temperature °C		Water yielding temperature °C							
		30		35		40		45	
°C DB	°C WB	TC kW	PI kW	TC kW	PI kW	TC kW	PI kW	TC kW	PI kW
-7	-7.6	24.6	6.37	24.1	7.68	23.5	8.50	22.7	9.19
-5	-5.6	24.9	6.48	24.6	7.81	24.1	8.64	23.2	9.36
-3	-3.7	25.5	6.56	25.2	7.92	24.6	8.76	23.8	9.50
0	-0.7	26.6	6.17	26.0	7.71	25.5	8.79	24.4	10.40
3	2.2	28.0	5.76	28.0	7.20	28.0	8.21	25.2	9.36
5	4.1	28.0	5.55	28.0	6.93	28.0	7.90	28.0	9.01
7	6	28.0	5.33	28.0	6.67	28.0	7.60	28.0	8.67
9	7.9	28.0	5.14	28.0	6.42	28.0	7.32	28.0	8.35
11	9.8	28.0	4.95	28.0	6.19	28.0	7.05	28.0	8.05
13	11.8	28.0	4.77	28.0	5.97	28.0	6.80	28.0	7.76
15	13.7	28.0	4.61	28.0	5.77	28.0	6.57	28.0	7.51

7.6 Revision of length and fall difference of connecting pipe

GMV-S120WL/A-S, GMV-S140WL/A-S, GMV-S160WL/A-S

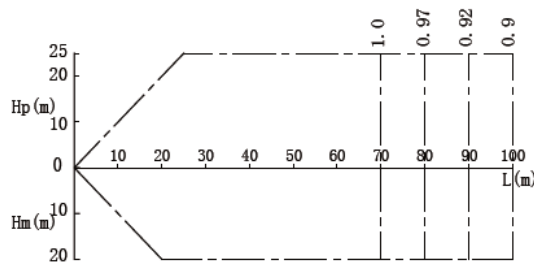
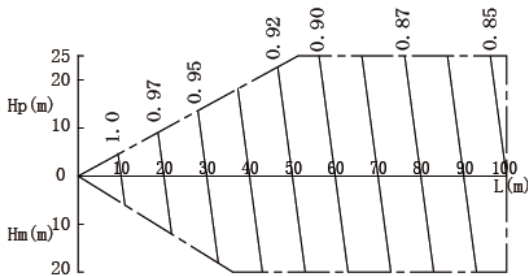

1) Change rate of cooling capacity

GMV-S224W/A-X, GMV-S280W/A-X

2) Change rate of heating capacity

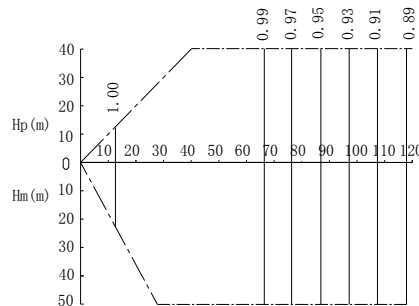
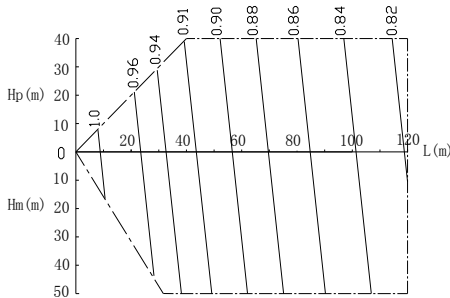

1) Change rate of cooling capacity

Instruction:

2) Change rate of heating capacity

- 3) Hp: Height difference (m) between two units when indoor unit is in lower position of outdoor unit;

- 4) Hm: Height difference (m) between two units when indoor unit is in higher position of outdoor unit;
- 5) L: One way equivalent pipe length

7.7 Heating frosting revision factor

When outdoor environment satisfies certain conditions (temperature and humidity conditions), unit may appear frosting or defrosting situation, which will weaken heating capacity of whole unit, thus please calculate frosting revision factor for heating load model selection.

Frosting revision factor is as below:

Air inlet dry bulb temperature of outdoor heat exchanger (°C/RH85%)	-11	-9	-7	-5	-3	0	3	5	7
Revision factor of whole unit (defrosting) capacity	1	0.98	0.96	0.94	0.88	0.8	0.84	0.9	1

8. Product Model Selection

8.1 Notices for model selection

8.1.1 Model selection and installation

Item	Contents	Instruction
Model selection and installation	This unit must connect to indoor unit of air conditioner, and total rated capacity of indoor unit should account for 80%~100% of rated capacity of outdoor unit	If it's too low, it will impact defrosting effect, and if it's too high, it will increase energy consumption of heating water in winter;
	For design and installation of embedding pipe of floor heating: clearance between floor heating pipes should be within 100~150mm, and pipe diameter should be as large as possible within the selectable range (it is recommended to be over DN20);	1. Heat pump belongs to low-temperature heat source, the water yielding temperature can be 35~40°C under high energy efficiency. So when designing floor heating, please do not design according to centralized heating of boiler. 2. If clearance between floor heating pipes is too large, and pipe diameter is too small, it will increase heat load and water resistance, which will cause low heat exchange efficiency and increase of energy consumption.
	Floor heating should be controlled by different rooms, and install floor heating shunt valve (floor heating performer). Floor heating can be controlled for designated room. New generation hot water generator can directly control floor heating shunt valve, for specific operation can refer to instruction manual of hot water generator.	It can avoid turning on floor heating of all the rooms. This function is energy-saving.

GMV5 Home DC Inverter Multi VRF Units

	<p>Route quantity of water knockout drum and water collector should not be over 6, if it's over 6, it should be divided or combined. Water knockout drum (floor heating shunt valve) should install electric shunt valve (single phase 220V~, normally closed type), and should connect power cord to electric box of Gree generator, and automatically controlled by generator. Set wired controller of air conditioner to control shunt valve of designated room. For specific operation please refer to circuit diagram of generator and instruction manual of generator.</p>	<p>It can avoid turning on floor heating of all the rooms. This function is energy-saving. Wired controller for controlling on and off of shunt valve of designated room is provided by Gree (it should set linkage function). There is no need for users to purchase floor heating temperature controller separately.</p>
	<p>When installing floor heating, resistance of water system should be calculated to decide whether it needs to install engineering water pump. Generator provides external pipelines with 1.7m³/flow and 6m delivery lift. When water pump in generator cannot satisfy the requirement of delivery lift, it can externally connect to engineering water pump. Recommended model of engineering water pump: Wilo RL-25/7.5. Engineering water pump should connect to electric box of Gree generator, and is automatically controlled by generator, for specific operation please refer to circuit diagram of generator;</p>	<p>If resistance of water system is great and there is no engineering water pump, or delivery lift of engineering water pump is relatively low, it will cause small water flow and poor heating effect that cannot reach the setting heating temperature, and energy consumption of unit will be large;</p>
	<p>Install 3 kg-force dropping valve in closed circulating water system between water tank and hot water generator. Dropping valve has been packed with generator as accessory.</p>	<p>When water pressure becomes large, safety valve of hot water generator will leak water and will impact water heating effect;</p>
	<p>In package of generator, there are C valve and D valve for water system, please install according to actual situation; please note that even only install water tank or only install floor heating for generator, C valve and D valve should be installed.</p>	<p>Install C valve and D valve in water system can switch between heating water mode and floor heating mode. Please note that if it only installs water tank, C valve should be installed. If it only installs floor heating function, D valve should be installed.</p>

8.1.2 Usage

Item	Contents
Using hot water	It is suggested that in summer, temperature of hot water can be set around 45°C; in winter, temperature of hot water can be set to be 50°C or below 50°C.
	It's better to use hot water in higher temperature of a day in winter (It can set via preset, timer, sunflower and related functions, preset and timer functions are circularly effective).
Using floor heating	Before using floor heating function, please start up the function for preheating. Please conduct preheating 4~6 hours before using the floor heating function; debugging should be conducted 12 hours before using floor heating function, and should use after the walls are dried, which is more energy-saving;
	If user wants to turn on "air conditioner heating and floor heating", then the total load should not be over rated heating capacity of outdoor unit, otherwise the heating effect will be weakened.
	If floor heating effect is poor, please turn off the air conditioner in the same room, or turn on the air conditioner and floor heating in other rooms.

8.2 Overall Model Selection Steps

8.2.1 Air conditioner+heating water+floor heating, air conditioner+floor heating

- 1) Define using demand as: air conditioner+heating water+floor heating, air conditioner+floor heating.
- 2) For defining model selection and collocation of outdoor unit, indoor unit, generator and water tank, please refer to "VI. Product model selection and collocation".
- 3) Model selection of air conditioner (indoor unit, outdoor unit) ——according to air conditioning load of room (according to cooling load or heating load), and then select indoor unit and outdoor unit; procedures for model selection are the same as that of general multi VRF unit.
- 4) Model selection of generator——according to floor heating load of room to select generator; quantity of generator should be ≤ maximum allowable quantity of generator for connecting outdoor unit; actual floor heating capacity of generator should satisfy requirement of floor heating load.
- 5) Model selection of water tank——according to hot water using demand of user to select model of water tank; quantity of water tank should be ≤ quantity of generator; if using method is "air conditioner+floor heating", then skip this step.
- 6) Floor heating engineering design (pipe distance, pipe diameter, route quantity of coil pipes of each room, quantity and layout of)

8.2.2 Air conditioner+heating water

- 1) Define using demand of user as: air conditioner + heating water.
- 2) For defining model selection and collocation of outdoor unit, indoor unit, generator and water tank, please refer to "VI. Product model selection and collocation".
- 3) Model selection of air conditioner (indoor unit, outdoor unit) ——according to air conditioning load of room (according to cooling load or heating load), and then select

indoor unit and outdoor unit; procedures for model selection are the same as that of general multi VRF unit.

- 4) Model selection of water tank——select model of water tank according to water using demand of user; capacity of inner-coil water tank (tie-in generator) is 200/300/350/400L.
- 5) Model selection of generator——select generator according to quantity of water tank; quantity of inner-coil water tank should equal to quantity of generator; quantity of generator should be ≤ maximum allowable quantity of generator for connecting outdoor unit.

8.3 Model selection example 1: air conditioner + heating water + floor heating, air conditioner + floor heating

8.3.1 Basic conditions

Applicable location: general villa.

Temperature conditions: take cooling load as principle of model selection --- outdoor temperature: 35°CDB; indoor wet bulb temperature: 21°CWB.

Cooling load:

Room	Room A	Room B	Room C	Room D	Room E	Room F	Room G	Room H
Load (kW)	2	2	3	3	3	3	3	4

Equivalent length of longest pipeline from outdoor unit to indoor unit: 30m, height difference between indoor and outdoor unit: 10m (outdoor unit is in lower position).

Condition of floor heating:

	Room A	Room B	Room C	Room D	Room E	Room F	Room G	Room H
Area m ²	/	/	15	15	15	15	20	/
Purpose	/	/	Study	Guest room	Guest room	Guest room	Main bedroom	/
With floor heating or not	No	No	Yes	Yes	Yes	Yes	Yes	No

Water using condition: there are five persons; one bathtub (with shower), two showers, three washbasins.

8.3.2 Define using demand of user

According to the above conditions we can define the using demand of user is: air conditioner+heating water+floor heating.

8.3.3 Define collocation method of unit

For defining model selection and collocation of outdoor unit, indoor unit, generator and water tank, please refer to “VI. Product model selection and collocation”.

8.3.4 Model selection of air conditioner

According to air conditioning load of room (according to cooling load or heating load), and then select indoor unit and outdoor unit; procedures for model selection are the same as that of general multi VRF unit.

8.3.4.1 Initial selection of indoor unit

Due to long pipeline distance and there is a certain height difference between indoor and outdoor unit, first user can select the indoor unit with rated cooling capacity larger than cooling load of room, selected results are as below:

	Room A	Room B	Room C	Room D	Room E	Room F	Room G	Room H
--	--------	--------	--------	--------	--------	--------	--------	--------

GMV5 Home DC Inverter Multi VRF Units

Load (kW)	2	2	3	3	3	3	3	4
Specification	25 type	25 type	36 type	36 type	36 type	36 type	36 type	45 type
Capacity code	25	25	36	36	36	36	36	45

8.3.4.2 Initial selection of outdoor unit

(1) Basic principle for model selection of outdoor unit:

- 1) Know well about using habit of user, before using the unit, total capacity of indoor units operated simultaneously should not be larger than capacity of outdoor unit, otherwise it may cause deficiency in cooling (heating) of indoor units.
- 2) Sum of capacity codes of indoor unit should be within 80%~100% of capacity of selected outdoor unit.
- 3) According to different factors in actual installation, it is suggested that capacity code of outdoor unit should not be less than sum of capacity code of indoor units.

(2) Initial selection of capacity of outdoor unit

1) Calculate demand of total cooling capacity of indoor unit

Sum of the above capacity code of indoor units is $25 \times 2 + 36 \times 5 + 45 = 275$, that is, the actual cooling capacity is 27.5kW.

2) Define simultaneous utilization rate

According to actual using demand of user, all of the above indoor unit are turned on and used at the same time (simultaneous utilization rate is 1), so the rated capacity of selected outdoor unit should not be less than $27.5 \times 1 = 27.5\text{kW}$, otherwise it will cause poor cooling/heating effect in actual utilization.

Notes:

simultaneous utilization rate = sum of rated capacity of simultaneously operated indoor units / sum of rated capacity of all the indoor units.

(3) Selection of capacity of outdoor unit

Inquire rated capacity sheet of outdoor unit, capacity code of outdoor unit which is larger than 27.5kW and has smaller upper deviation is 280, that is to select outdoor unit with rated cooling capacity of 28kW.

(4) Calculate rated capacity ratio of indoor and outdoor unit

Rated capacity ratio of indoor and outdoor unit is $27.5 / 28 \times 100\% = 98\%$, the value is within 80%~100%, then the initial selected outdoor unit with capacity of 28kW is in conformity with requirements of model selection.

(5) Define model of whole unit

The model of outdoor unit that satisfies 28kW is GMV-S280W/A-X, therefore the selected model of whole unit is GMV-S280W/A-X.

8.3.4.3 Capacity revision of outdoor unit

Actual output capacity of outdoor unit will be affected by many factors such as installation (pipe length, height difference) and actual ambient temperature, thus rated capacity should be revised according to actual situation.

(1) Collocation rate of unit

Collocation rate of unit = sum of rated capacity of indoor units / rated capacity of outdoor unit
Calculate collocation rate of unit is: $(25 \times 2 + 36 \times 5 + 45) / 280 = 98\%$

(2) Capacity revision coefficient of ambient temperature

Inquire cooling capacity revision sheet related to temperature, under the condition of outdoor temperature of 35°CDB, indoor temperature of 29°CDB, collocation rate of unit is 98%, cooling capacity is 28.6kW. **【For specific capacity revision data please see ralted instruction manual】**

(3) Capacity revision coefficient of pipe length and height difference

Upon inquiry, for the corresponding length of pipe is 30m and height difference between indoor and outdoor unit is 10m (outdoor unit is in lower position), the revision coefficient is 0.95.

【For specific revision contents of connecting pipe please see related instruction manual】

(4) Calculation of actual capacity of outdoor unit

Actual capacity of outdoor unit=calculated rated capacity of outdoor unit×capacity revision coefficient of pipe length and height difference

$$\text{Actual capacity of outdoor unit}=28.6 \times 0.95=27.17\text{kW}$$

8.3.4.4 Checkup of actual output capacity of each indoor unit

(1) Calculate actual output capacity of each indoor unit

Actual output capacity of each indoor unit=actual capacity of indoor unit×rated capacity of indoor unit/total rated capacity of indoor unit.

In this example, actual output capacity of each indoor unit is as below:

$$\text{GMV-NHD25PL/A-T: } 27.17 \times 25 / 275 = 2.47\text{kW}$$

$$\text{GMV-NHD36PL/A-T: } 27.17 \times 36 / 275 = 3.56\text{kW}$$

$$\text{GMV-NHD45PL/A-T: } 27.17 \times 45 / 275 = 4.45\text{kW}$$

(2) Checkup of capacity of indoor unit

Checkup principle: actual output cooling capacity of each indoor unit is larger or equal to 100% of heating load of room

Comparison of load of room and indoor unit are as below:

	Room A	Room B	Room C	Room D	Room E	Room F	Room G	Room H
Load (kW)	2	2	3	3	3	3	3	4
Actual output capacity of indoor unit (kW)	2.47	2.47	3.56	3.56	3.56	3.56	3.56	4.45

From the above sheet we can see that all the model selections for rooms have satisfied the requirements.

If it cannot satisfy requirement, please calculate from the second step till it satisfies the requirement.

8.3.5 Model selection of generator

8.3.5.1 Calculation of floor heating load

Select generator according to floor heating load of room; it is required that quantity of generator should be ≤ maximum allowable connecting quantity of generator for outdoor unit

Model selection principle is based on floor heating load: outdoor temperature: -3°CDB; water supply temperature of generator: 40°C.

For defining unit of floor heating load, according to empirical value, floor heating load of general residences are as below:

	Residence	Villa
Restaurant (W/m ²)	120~150	140~170
Bedroom (W/m ²)	120~140	130~150
Guest room (W/m ²)	130~160	130~160
Study (W/m ²)	120~140	130~150

Notes:

- (1) Generally load of villa is larger than that of residential house, take median value to upper limit value.
- (2) Load of top floor of villa should be larger than middle floors or ground floor, take upper limit value.

- (3) Load of guest room is generally large, take median value to upper limit value.
- (4) For the room with many exterior walls, with large area or large area of glass, it is suggested to calculate the load.
- (5) Floor heating load of toilet should take 500W/room.

Calculation result of floor heating load of different rooms are as below:

	Room A	Room B	Room C	Room D	Room E	Room F	Room G	Room H
Area m ²	/	/	15	15	15	15	20	/
Purpose	/	/	Study	Guest room	Guest room	Guest room	Main bedroom	/
With floor heating or not	No	No	Yes	Yes	Yes	Yes	Yes	No
Load of floor heating (kW)	/	/	2.25	2.25	2.25	2.25	3	/

8.3.5.3 Initial selection of generator

Calculate according to the above floor heating load, the total floor heating load is: $2.25 \times 4 + 3 = 12\text{kW}$. Initial selected generator is: one 16kW NRQD16G/A-S generator.

In addition, in initial selection of generator, it can also conduct initial selection according to floor heating area. At present, the generator of our company is NRQD16G/A-S, one generator can serve the area of about 100 m².

8.3.5.3 Checkup of quantity and capacity of generator

According to model selection of air conditioner, outdoor unit GMV-S280W/A-X with 25kW is selected.

Model	Limit for rated capacity of indoor unit accounting for rated capacity of outdoor unit	Limit for quantity of generator
GMV-S120WL/A-S	80% ~ 100%	1
GMV-S140WL/A-S	80% ~ 100%	1
GMV-S160WL/A-S	80% ~ 100%	1
GMV-S224W/A-X	80% ~ 100%	2
GMV-S280W/A-X	80% ~ 100%	2

Checkup of floor heating capacity of generator should calculate according to floor heating capacity of outdoor unit.

Floor heating capacity of each generator = revised floor heating capacity of outdoor unit / quantity of generator, but the maximum capacity should not be over 16kW. So actual floor heating load of each generator should be basically equal.

Floor heating capacity of outdoor unit is calculated according to “revised floor heating capacity”:

In this example, actual floor heating capacity of generator = 16kW, (calculating value = $24.6 / 1 = 24.6\text{kW}$, but the maximum capacity should be 16kW). Then actual floor heating capacity of generator 16kW \geq floor heating load 12kW. So the selected model of generator is passed.

If the calculated floor heating capacity of generator (add 3kW electric heating capacity) is less than floor heating load, then user should reselect outdoor unit (select outdoor unit with larger capacity).

8.3.6 Model selection of water tank

(If using way of user is “air conditioner+floor heating”, then please skip this step) ——select model of water tank according to water using demand of user;

It is required that quantity of water tank is \leq quantity of generator;

Model selection principle: calculate “water consumption of user” according to “number of people and per capita water consumption” and “water consumption of bathroom accessories” respectively, and take the larger value. And then calculate “water storage capacity of water tank”, that is, cubic capacity of water tank.

8.3.6.1 Calculation of water consumption

According to related standard or experience

(1) According to per capita water consumption

Construction	Unit	Designed daily water consumption (L)	Using water temperature (°C)
Residence	Per day, per capita	40~80	60
Villa	Per day, per capita	70~110	60

(2) According to water consumption of bathroom accessories

Bathroom accessory	Using water temperature (°C)	One-time water consumption (L)
Bathtub (with shower)	40	150
Bathtub (without shower)	40	125
Shower	37~40	70~100
Washbasin	30	3

In this case, there are five persons; one bathtub (with shower), two showers, three washbasins;

Calculate “water consumption of user” according to “number of people and per capita water consumption”: $5 \times 70 = 350L$;

Calculate “water consumption of user” according to “water consumption of bathroom accessories”: $150 + 70 \times 2 + 3 \times 3 = 299L$;

Take simultaneous utilization rate as 0.7; then total water consumption of user $= 350L \times 0.7 = 245L$;

Calculation for water consumption of user		
According to per capita consumption		
Item	Quantity	Per capita water consumption (per day, per capita) L
People	5 persons	70
Total water consumption	$5 \times 70 = 350L$;	
According to bathroom accessories		
Item	Quantity	One-time water consumption of unit quantity (L)
Bathtub (with shower)	One	150
Shower	Two	70
Washbasin	Three	3
Total water consumption	$150 + 70 \times 2 + 3 \times 3 = 299L$	
Simultaneous utilization rate: 0.7 at most		
Final defined total water consumption: $350L \times 0.7 = 245L$		

8.3.6.2 Calculation for water storage capacity (cubic capacity) of water tank

Water storage capacity of water tank = $(t_{\text{model selection designed water temperature}} - t_{\text{cooling water entering temperature}}) \times \text{total water consumption of user} / (t_{\text{heating temperature of water tank}} - t_{\text{cooling water entering temperature}})$

$t_{\text{model selection designed water temperature}}$ —— in consideration of the temperature when

using the water, generally it takes 60°C;

t cooling water entering temperature——cooling water entering temperature is selected according to regions; east China region can take 5°C;

t heating temperature of water tank—— in consideration of energy-saving purpose, generally it takes 50°C.

In this example, water storage capacity of water tank is $245L * (60-5) / (50-5) = 299L$.

8.3.6.3 Define model of water tank

Select corresponding model of water tank according to the above calculation and combining with collocation relationship of unit. In this example, select one set of SXVD300LCJ/A-K water tank and used it by collocating with generator.

8.3.7 Design of floor heating engineering

Floor heating design is to design water supply temperature, pipe clearance, pipe diameter, route quantity of coil pipes in each room, quantity of water knockout drum and water collector and layout method.

For contents of this part please refer to related design instruction and criterion. The following are points for attention in design of floor heating engineering:

- (1) Floor heating water supply temperature: in consideration of feature of air sourced heat pump water heater and energy-saving purpose, generally it is designed as 40°C, highest temperature is 45°C;
- (2) Pipe clearance/pipe diameter: pipe clearance is better to be within 100~150mm; pipe diameter should be as large as possible within the selectable range (it is recommended to be over DN20). Otherwise, the oversize of clearance or undersize of pipe diameter will cause increase of heating load and water resistance, and the heat exchange efficiency will be lowered, energy consumption is greatly increased.
- (3) Layout of pipeline in the room: generally there are “rectangular-ambulatory-plane” and “U-shape” layout, “rectangular-ambulatory-plane” is recommended.
 “rectangular-ambulatory-plane”: pipe length=L*W/pipe clearance=area/pipe clearance;
 “U-shape”: pipe length=L-1+L*W/pipe clearance=L-1+area/pipe clearance;

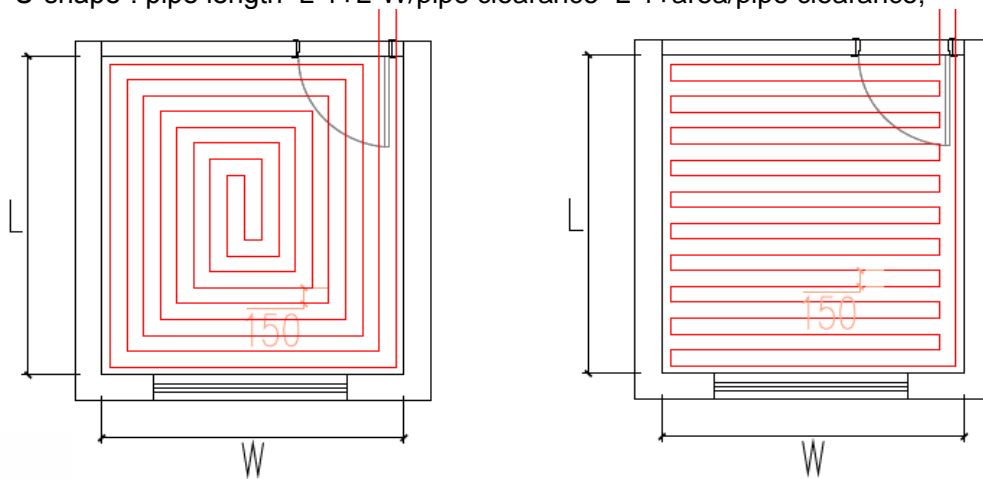

“rectangular-ambulatory-plane”

“U-shape”

- 1) Pipe length of single water loop should not be over 100m, if it's over the length, it should be divided into several loops; length of each branch pipe should be equally the same as much as possible;
- 2) Route quantity of water knockout drum and water collector should not be over 6, if it's over 6, it should be divided or combined. Water knockout drum (floor heating shunt

valve) should install electric shunt valve (single phase 220V~, normally closed type), and should connect power cord to electric box of Gree generator, and automatically controlled by generator. Set wired controller of air conditioner to control shunt valve of designated room. For specific operation please refer to circuit diagram of generator and instruction manual of generator.

Sketch map is as below:

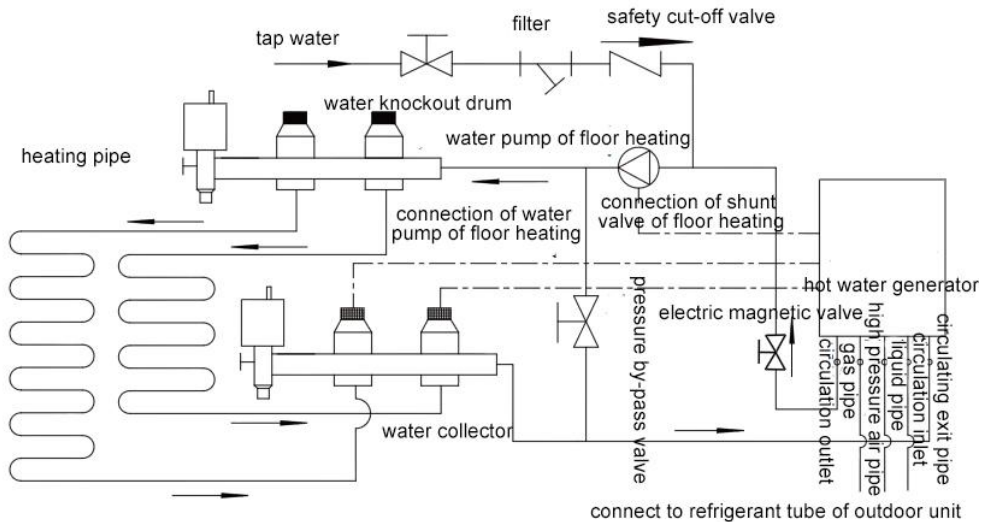

- 3) Branch pipe of water knockout drum and water collector should not cross the floor, if it needs to install in two floors, two sets of water knockout drum and water collector should be adopted. Generally water knockout drum and water collector can be installed near the walls such as equipment room, kitchen, passageway, etc.
- 4) Generator: generally it will not install by crossing the floors. If it needs to cross the floors, water power should be calculated, or two sets of generators can be adopted.
- 5) Generator: provide external pipe network with 1.7m³/h flow and 6m delivery lift. When water pump of generator cannot satisfy requirement of delivery lift, it can externally connect to engineering water pump. Recommended model of engineering water pump: Wilo RL-25/7.5. Engineering water pump should connect to electric box of Gree generator, and is automatically controlled by generator, for specific operation please refer to circuit diagram of generator;
- 6) Before model selection and installation, please read the instruction manual of unit carefully.

8.3.8 Final conclusion for model selection of whole unit

Usage mode: air conditioner+heating water+floor heating				
Model of outdoor unit		Indoor unit	Generator	Water tank
Top discharge	GMV-S280W/A-X	GMV-ND25PL/A-T: 2 GMV-ND36PL/A-T: 5 GMV-ND45PL/A-T: 1	NRQD16G/A-S	SXVD300LCJ/A-K: 1 SXVD300LCJ/A-K: 1

8.4 Model selection example 2: air conditioner + heating water

8.4.1 Basic conditions

Applicable location: general villa.

Temperature conditions: take cooling load as principle of model selection --- outdoor temperature: 35°CDB; indoor wet bulb temperature: 21°CWB.

Cooling load:

Room	Room A	Room B	Room C	Room D	Room E	Room F	Room G	Room H
Load (kW)	2	2	3	3	3	3	4	4

Equivalent length of longest pipeline from outdoor unit to indoor unit: 30m, height difference between indoor and outdoor unit: 10m (outdoor unit is in lower position).

Water using condition: there are five persons; one bathtub (with shower), two showers, three washbasins.

Floor heating: no.

8.4.2 Define using demand of user

According to the above conditions, the using demand of user is: air conditioner+heating water.

8.4.3 Define collocation method of unit

For defining model selection and collocation of outdoor unit, indoor unit, generator, and water tank, please see "VI. Product model selection and collocation".

8.4.4 Model selection of air conditioner

Select indoor unit and outdoor unit according to air conditioning load of room (according to cooling load or heating load); the steps for model selection are the same as that of general multi VRF unit;

For specific information please refer to instruction and example illustrated in "8.3.4 Model selection of air conditioner".

In this example, selected models of outdoor and indoor units are as below:

Model of outdoor unit		Indoor unit
Top discharge	GMV-S280W/A-X	GMV-ND25PL/A-T: 2 GMV-ND36PL/A-T: 5 GMV-ND45PL/A-T: 1

8.4.5 Model selection of water tank

Select model of water tank according to hot water using demand of user; capacity of inner-coil water tank (tie-in generator) is 200/300/350/400L.

For specific information please refer to instruction and example illustrated in "8.3.6 Model selection of water tank".

In this example, water storage capacity of water tank is $245L * (60-5) / (50-5) = 299L$; so select one set of water tank with model of SXVD300LCJ/A-K, which is used by collocating with generator.

8.4.6 Model selection of generator

Select generator according to quantity of water tank;

It is required that quantity of inner-coil water tank = quantity of generator;

Quantity of generator ≤ maximum allowable connecting quantity of generator for outdoor unit

In this example, the selected water tank is SXVD300LCJ/A-K, quantity is one; thus model selection of generator is: NRQD16G/A-S, quantity is one.

8.4.7 Final conclusion for model selection of whole unit

Usage mode: air conditioner+heating water				
Model of outdoor unit		Indoor unit	Generator	Water tank
Top discharge	GMV-S280W/A-X	GMV-ND25PL/A-T: 2 GMV-ND36PL/A-T: 5 GMV-ND36PL/A-T: 1	NRQD16G/A-S: 1	SXVD300LCJ/A-K: 1

Chapter 2: Control

1. Unit Control

1.1 General Control Method

1.1.1 Schematic Diagram of Unit Control

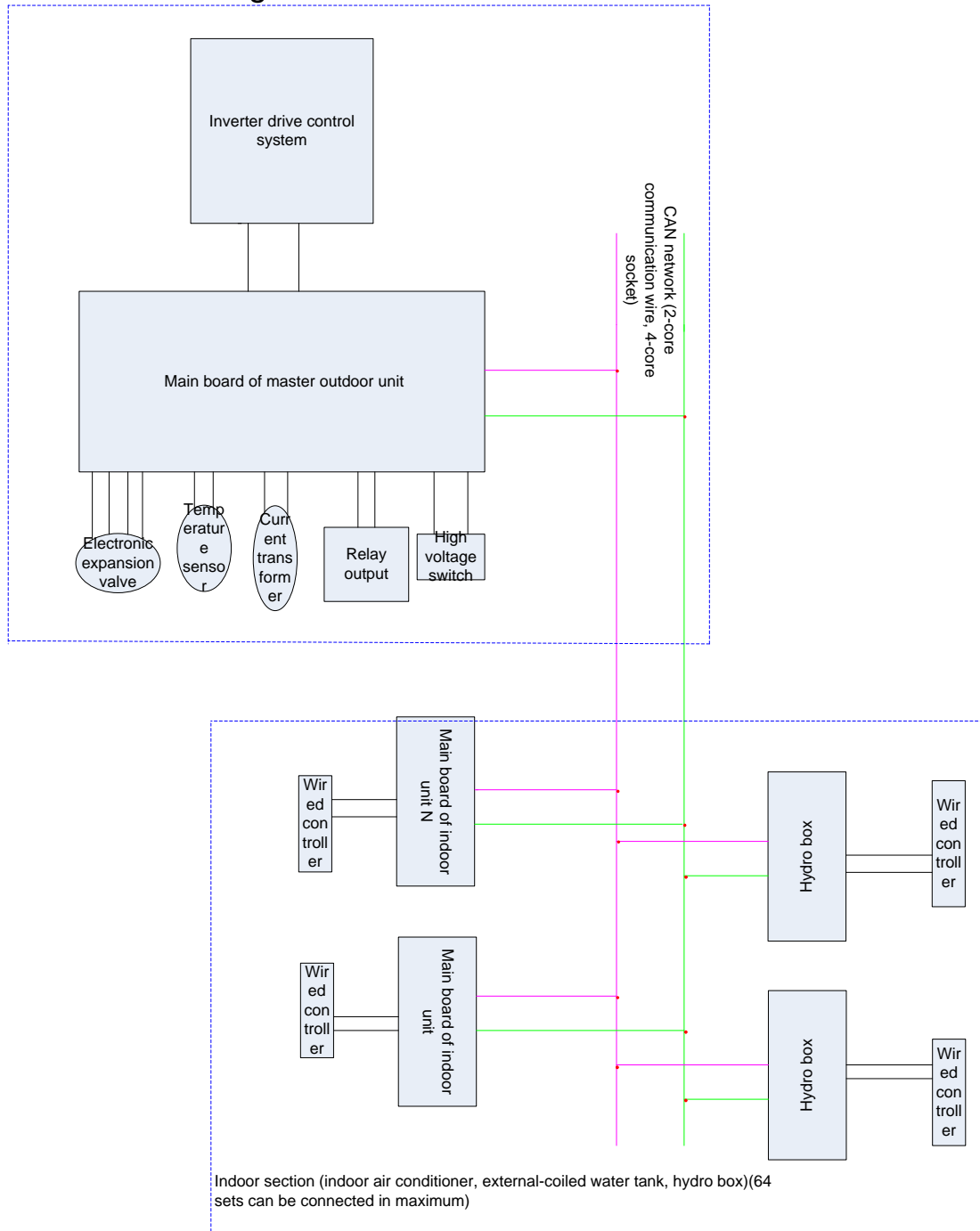

GMV5 Home System includes one outdoor unit and 64 indoor units (indoor air conditioner, external-coiled water tank and hydro box). Up to 6 external-coiled water tanks and hydro boxes can be connected. Communication between indoor units and outdoor unit is connected by CAN network 2-core (4-core needle stand) communication wire. It adopts non-polar auto addressing method to realize communication, no need of setting address manually. During engineering installation, it is necessary to set up outdoor unit main board DIP switch correctly to define the special application functions. Below are the definitions:

GMV5 Home DC Inverter Multi VRF Units

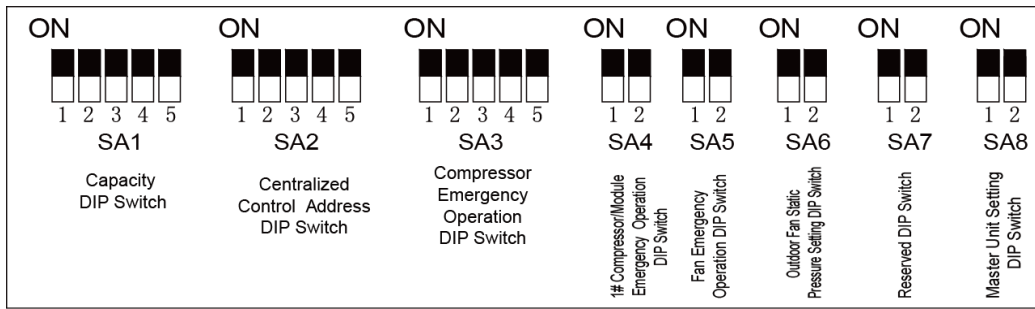

Capacity DIP Switch (SA1):

Outdoor capacity code	DIP switch (5 digits)				
	1	2	3	4	5
224	0	1	0	0	1
280	0	1	0	1	1
335	0	1	1	0	1
400	0	1	1	1	1
450	1	0	0	0	0
504	1	0	0	0	1

Remark: Only when the outdoor unit capacity DIP switch is correctly set, will the unit be able to run normally. If setting is wrong, outdoor unit will report capacity DIP switch error.

Centralized Control Address DIP Switch (CAN network address, SA2)

CAN2 address	DIP switch (5 digits)				
	1	2	3	4	5
Address 0	0	0	0	0	x
Address 1	1	0	0	0	x
Address 2	0	1	0	0	x
Address 3	1	1	0	0	x
Address 4	0	0	1	0	x
Address 5	1	0	1	0	x
Address 6	0	1	1	0	x
Address 7	1	1	1	0	x
Address 8	0	0	0	1	x
Address 9	1	0	0	1	x
Address 10	0	1	0	1	x
Address 11	1	1	0	1	x
Address 12	0	0	1	1	x
Address 13	1	0	1	1	x
Address 14	0	1	1	1	x
Address 15	1	1	1	1	x

Remark: If there are multiple systems, CAN2 network address should be set correctly. The address of one system must be set to 0, which means the master control system. All the other systems are slave systems. The centralized control address DIP switch cannot be the same among different systems. Otherwise, address conflicts may occur (It is a factory setting, no need of change).

Fan Emergency Operation DIP Switch (SA5)

Fan emergency operation DIP switch SA5		
Fan 1 emergency operation	Fan 2 emergency operation	Remark
DIP1	DIP2	
0	0	No fan in emergency operation
1	0	Error of fan 1

0	1	Error of fan 2
---	---	----------------

Remark: Only one fan can be set to emergency mode. If two or more fans are set to emergency mode, outdoor unit will report emergency operation setting error.

Static Pressure Setting DIP Switch (SA6)

Static pressure setting DIP switch SA6		Static pressure(Pa)
DIP1	DIP2	
0	0	0
1	0	20
0	1	50
1	1	80

Master Unit Setting DIP Switch (SA8)

If you turn the SA8 DIP switch on main board from position “1” to position “0”, the corresponding unit will become the master unit. “1” means slave unit while “2” is a null digit. Only one master unit is allowed for one system. The rest of the units should be slave units. Otherwise, outdoor unit will report “No Master Unit” or “Multiple Master Units” error (It is a factory setting, no need of change).

Explanation on Schematic Diagram

Master Control System

- ◆ Function: It is connected with the indoor section through 2-core (4-core needle stand) communication wire. When it receives on or off signal, mode signal, set temperature, ambient temperature from indoor unit, it will decide the operating mode of outdoor unit and calculate the proper operating frequency according to capacity, which will be sent back to the drive control system through 2-core (4-core needle stand) communication wire. It will also adjust fan speed according to system pressure and monitor the temperature sensed by each temperature sensor, the operating status and protection in real time, so as to make sure the whole system can work normally and reliably. If malfunction occurs, LED digital tubes of master control board will display the corresponding protection code. If malfunction occurs to drive, digital tubes of indoor unit will display drive malfunction code and LED digital tubes of master control board will display the specific malfunction type.

Input and Output Control Quantity:

- ◆ High voltage switch is used to identify system high voltage. When the high voltage is too high, high voltage switch will be disconnected. Main board receives the signal of high voltage switch breaking, and then transfers the signal to controller, which will display the error code. Unit won't start up.
- ◆ Ambient temperature sensor id used to sense the ambient temperature of outdoor unit. Controller will calculate the corresponding capacity according to the sensed ambient temperature.
- ◆ Defrosting temperature sensor is used to sense the actual temperature of the liquid side of outdoor unit condenser. Controller will judge according to the sensed temperature whether it is necessary to defrost or not.
- ◆ Condenser tube inlet temperature sensor is used to sense the refrigerant gas temperature of condenser and judge the heating evaporation temperature.
- ◆ Condenser tube outlet temperature sensor is used to sense the liquid side temperature of condenser for controlling the degree of sub-cooling.
- ◆ Gas separator inlet temperature sensor
- ◆ Gas separator outlet temperature sensor
- ◆ Sub-cooler liquid-extracting temperature sensor is used to sense the liquid outlet tube temperature of sub-cooler and judge the sub-cooling status in order to calculate the degree of sub-cooling.
- ◆ Sub-cooler gas outlet temperature is used to sense the gas outlet tube temperature of sub-cooler for controlling the degree of superheating of sub-cooler bypass flow.
- ◆ Discharge temperature sensor is used to sense the discharge temperature of outdoor

unit. Controller will adjust the compressor frequency according to the sensed temperature.

- ◆ High pressure sensor is used to sense the discharge pressure of outdoor unit. Controller will judge the corresponding fan speed, compressor frequency, electronic expansion valve opening position according to the sensed high pressure. When the high pressure is too high, unit will enter high pressure protection and controller will display the error code. Unit won't start up.
- ◆ Low pressure sensor is used to sense the low pressure of outdoor unit. Controller will judge the corresponding fan speed, etc. according to the sensed low pressure. When the low pressure is too low, unit will enter low pressure protection and controller will display the error code. Unit won't start up.
- ◆ The output of fan speed is controlled according to unit's operating mode, high pressure value and low pressure value.
- ◆ The on and off of 4-way valve A is controlled according to unit's operating mode. It's used to control heat exchanger of indoor unit.
- ◆ The on and off of 4-way valve B is controlled according to unit's operating mode. It's used to control heat exchanger of outdoor unit.
- ◆ The main electronic expansion valve is used to control the throttling flow of outdoor heat exchanger in heat mode.
- ◆ The slave electronic expansion valve or the sub-cooler electronic expansion valve is used to control the throttling evaporation flow of the gas side of sub-cooler.
- ◆ The outdoor throttling solenoid valve: It is used for outdoor unit condenser. When it is necessary to control flow, it will cut off the 1-way valve that is in parallel with EXV1.
- ◆ Solenoid valve (inlet 1): Inlet 1 solenoid valve of refrigerant regulator
- ◆ Solenoid valve (inlet 2): Inlet 2 solenoid valve of refrigerant regulator
- ◆ Solenoid valve (top discharge): Gas outlet solenoid valve of refrigerant regulator
- ◆ Solenoid valve (bottom discharge): Oil outlet solenoid valve of refrigerant regulator
- ◆ Gas bypass valve: Open once energized to realize hot gas bypass
- ◆ Pressure balance valve: It is used to reduce difference between high pressure and low pressure
- ◆ Output of compressor capacity is based on the capacity calculated by outdoor unit and will be sent to drive control. Drive control will output the actual compressor frequency according to the received frequency.
- ◆ Output of fan frequency is adjusted according to different mode, pressure and capacity.

Drive Control System

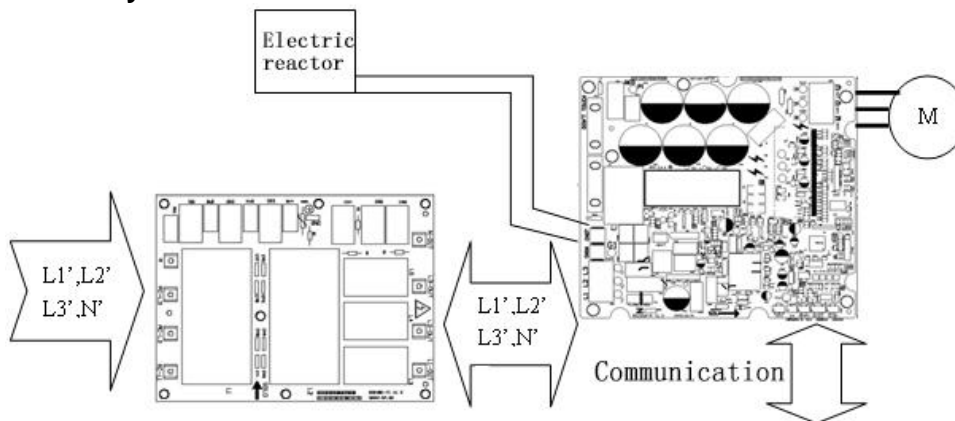

A. Filter Board: One of its purposes is to filter power interference when unit is under poor power quality condition. The other purpose is to prevent unit from interfering other electrical appliances, such as television. Because of the working mode of inverter, unit is sensitive to power interference and therefore filter board is needed. This unit adopts 3-phase power supply, so the filter board is a 3-phase filter board, whose input terminals are AC-L1, AC-L2, AC-L3 and N. The corresponding output terminals are L1-OUT, L2-OUT, L3-OUT and N-OUT.

B. Drive Board: It is a key element of the control system. It is used to receive signals from master control unit and transfer the 380V, 50Hz 3-phase power supply into alternate current whose amplitude and frequency are adjustable and drives the compressor to work.

Hydro Box Control System

Main board of hydro box: It communicates with outdoor unit, long-distance monitor and indoor air conditioners through the CAN bus. Besides, it supplies power to and communicates with wired controllers through HBS bus. On the main board, the 4-digit DIP switch is used to select hydro box model while the 5-digit DIP switch is used to select the capacity of hydro box. The sensing quantity of main board includes lower water temperature, upper water temperature, back water temperature, refrigerant inlet tube temperature, and refrigerant outlet tube temperature. Main board sends its status information to outdoor unit and receives control information from outdoor unit. It is also linked with the on and off, mode, set temperature and other data of indoor unit. It is used for floor heating as well.

Extension board of hydro box: It is used to sense the entering and leaving water temperature of hydro box, solar power water temperature, water flow switch, etc. and at the same time control floor heating performer, solar power water pump, hydro box electric heater, valve C and valve D.

Input and Output Control Quantity:

Water tank lower water temperature: The heating of water tank and water volume display are controlled according to the water temperature at the upper and lower part of the water tank,

Water tank upper water temperature: Water temperature at the upper part of water tank is sensed.

Water tank back water temperature: Cycle pump is controlled according to water tank back water temperature and water tank lower water temperature.

Refrigerant inlet tube temperature: Refrigerant temperature at the tube inlet will be sensed.

Refrigerant outlet tube temperature: Refrigerant temperature at the tube outlet will be sensed.

Hydro box entering water temperature: Entering water temperature of circulating water will be sensed. Floor heating is controlled according to the entering water temperature and leaving water temperature of hydro box.

Hydro box leaving water temperature: Leaving water temperature of circulating water will be sensed.

Solar power water temperature: Solar power water temperature will be sensed.

Water flow switch: It is used to protect the water pump when water flow is too small.

Valve A and valve B: They control the direction of refrigerant flow.

Electronic expansion valve: They control the volume of refrigerant flow.

Cycle pump: It controls the water temperature at user side.

Electric heater: It is used to heat water quickly or provide hot water quickly.

Floor heating performer: It is used to control floor heating room by room.

Solar power water pump: It controls the exchange between solar power hot water and water tank hot water.

Hydro box electric heater: It is used to control quick floor heating.

Valve C: It is used to control heating of internal-coiled water tank.

Valve D: It is used to control floor heating.

1.2 Operation Flowchart

1.2.1 Operation Flowchart of Indoor Air Conditioner

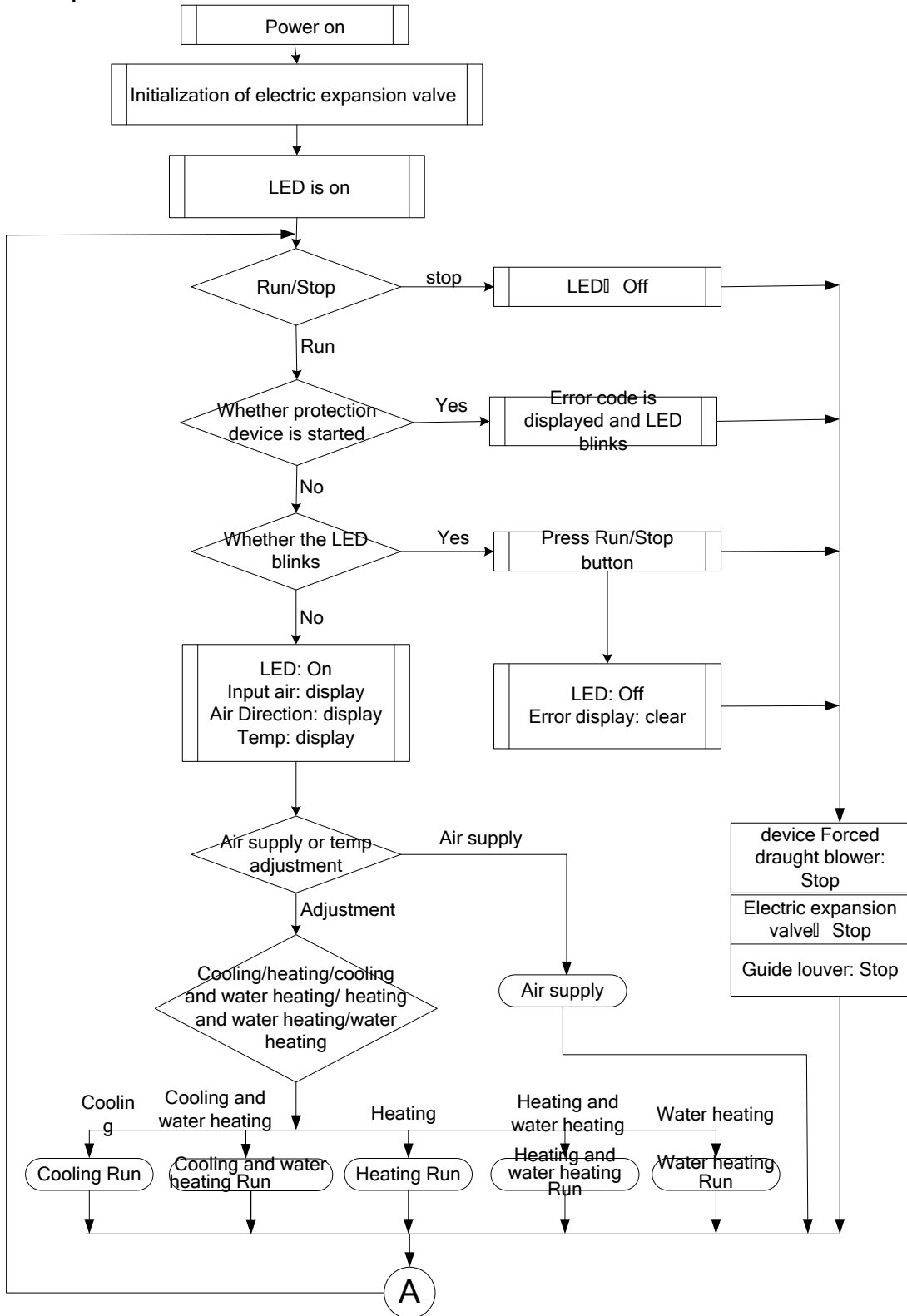

Cooling Operation

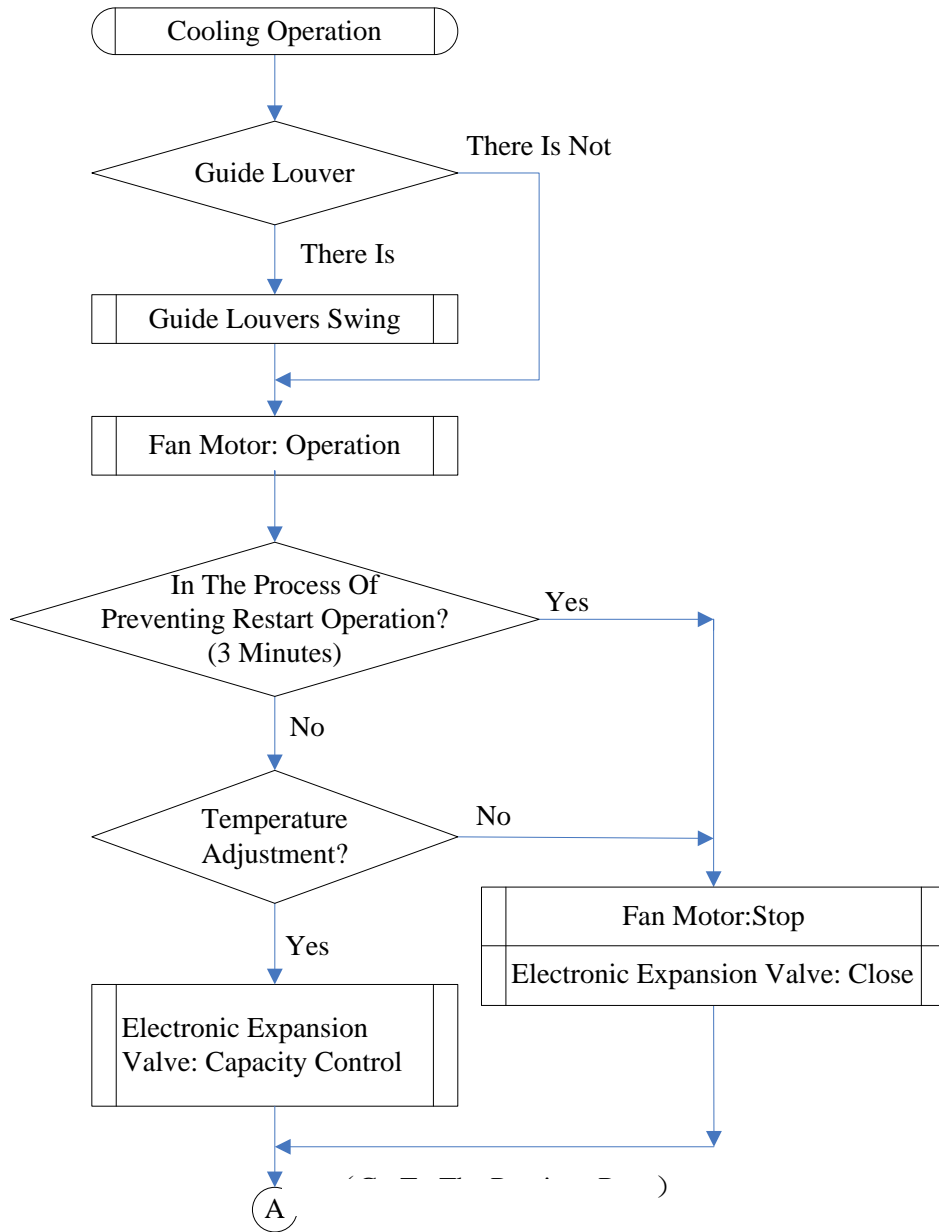

● Drying Operation

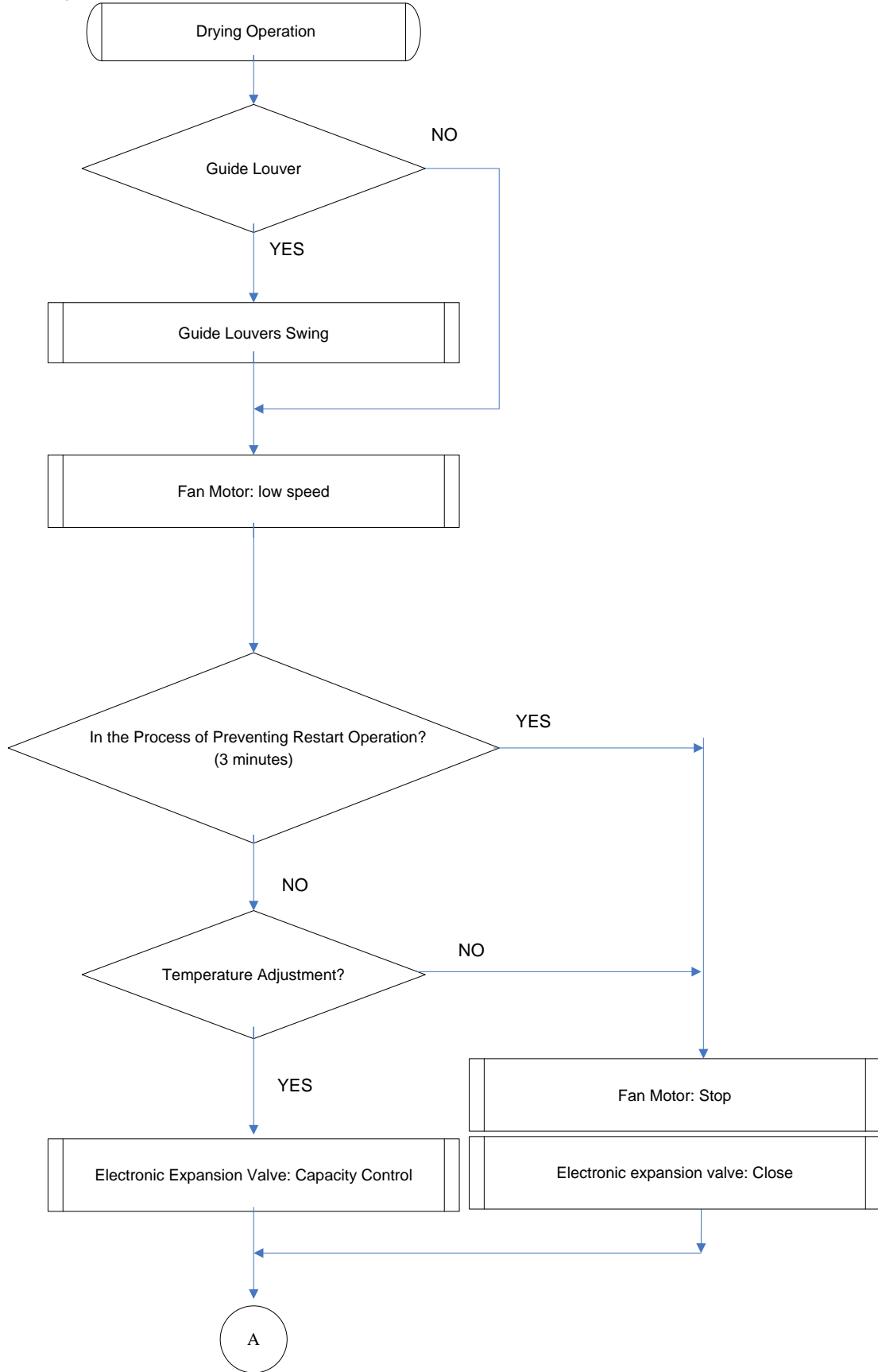

● Heating Operation

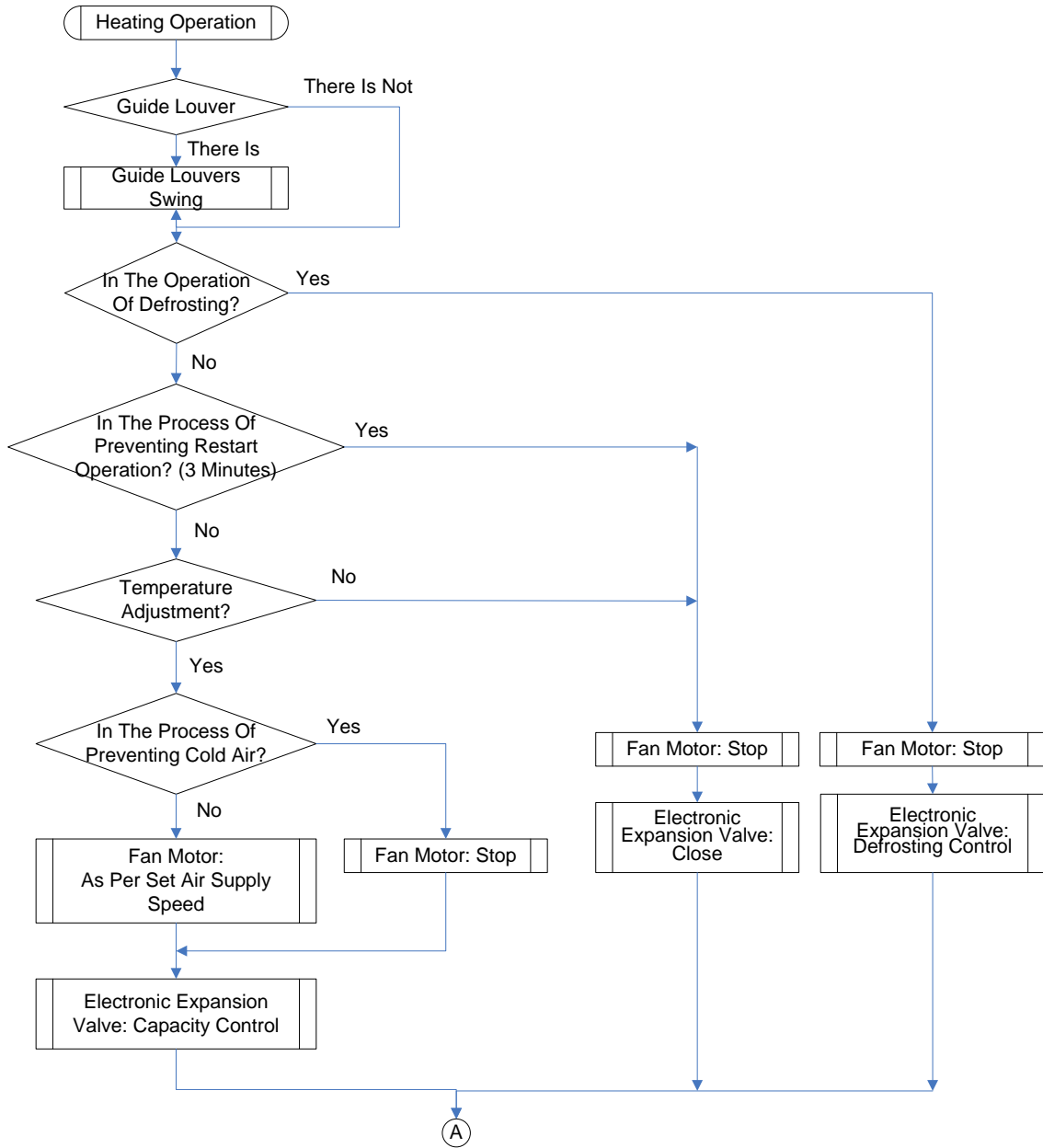

● Water Heating Operation

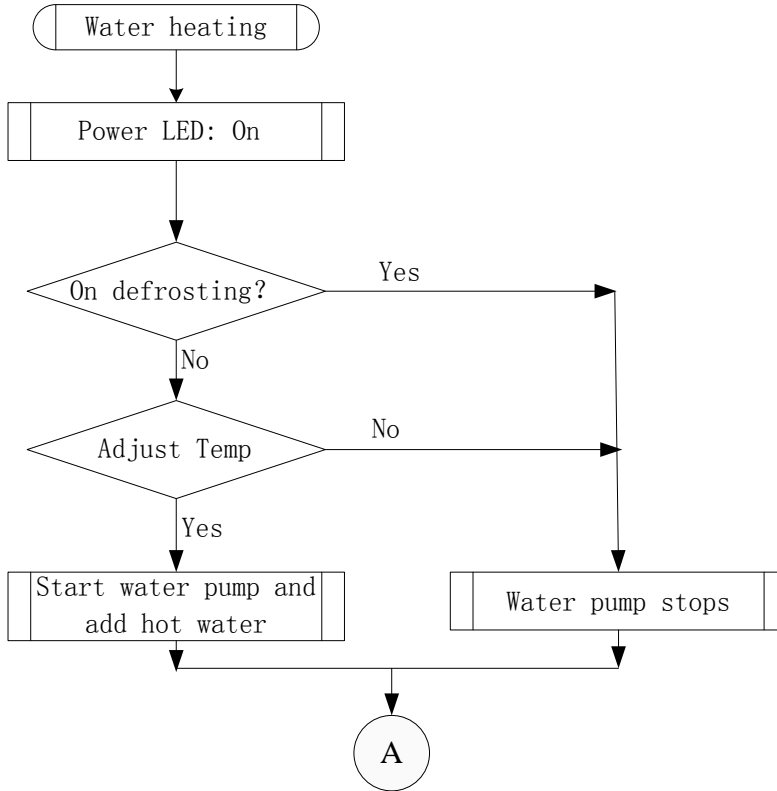

Cooling and Water Heating Operation

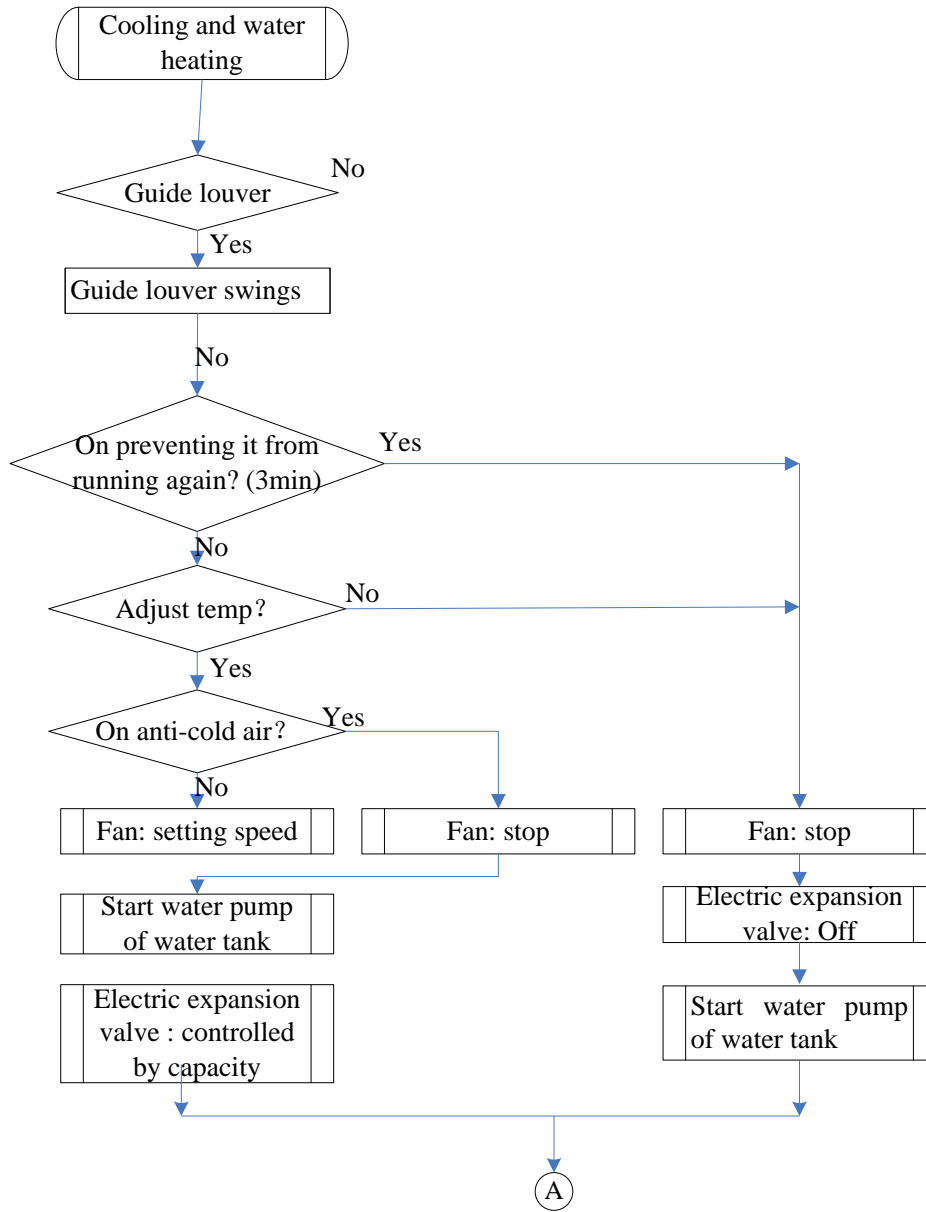

● Heating and Water Heating Operation

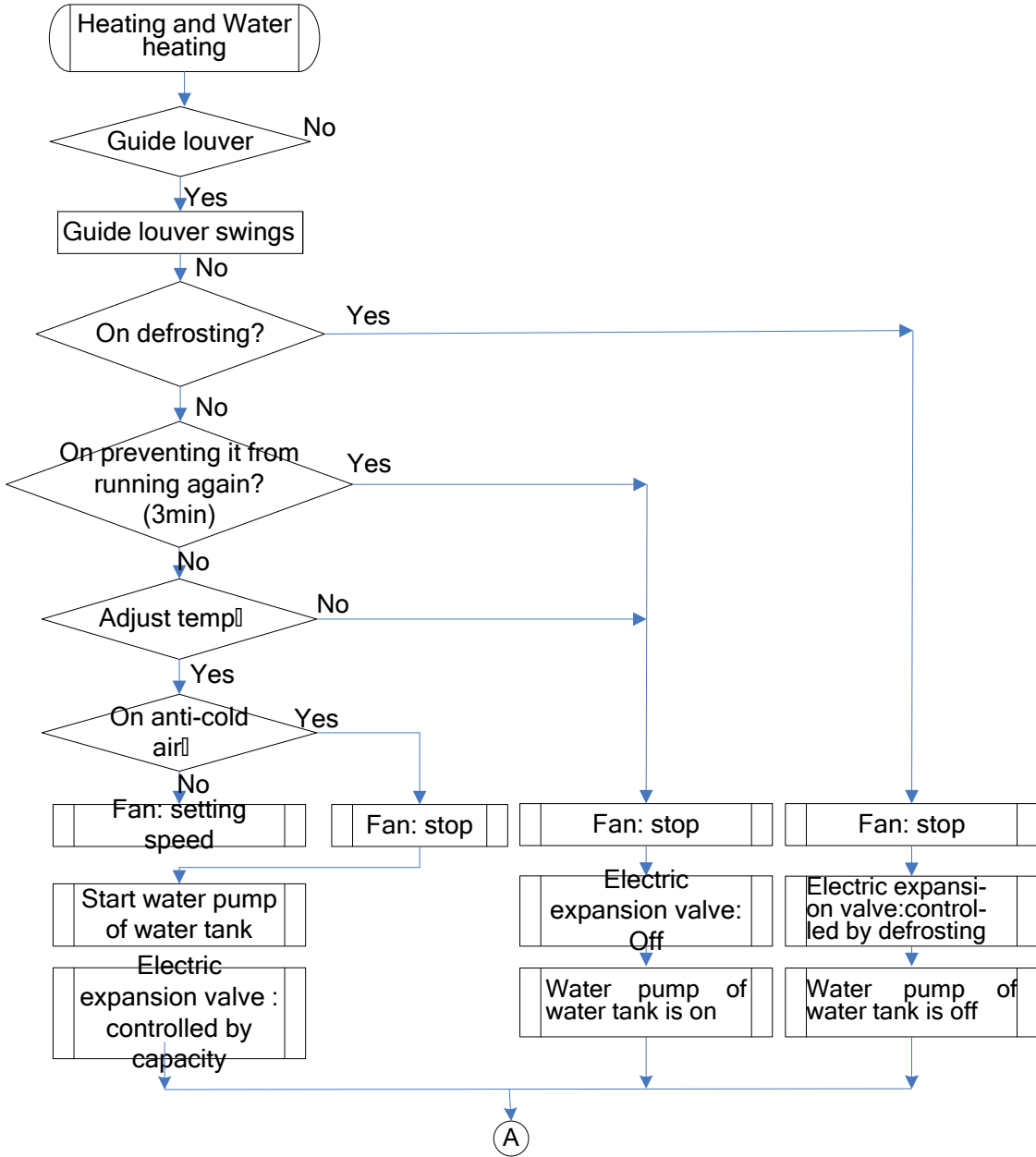

● Air Supply Operation

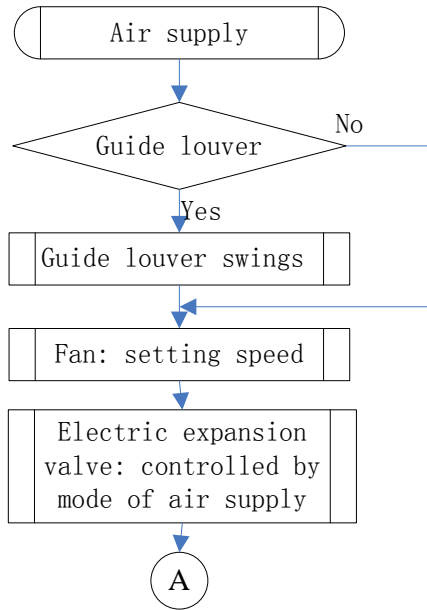

1.2.2 Operation Flow of Outdoor Unit

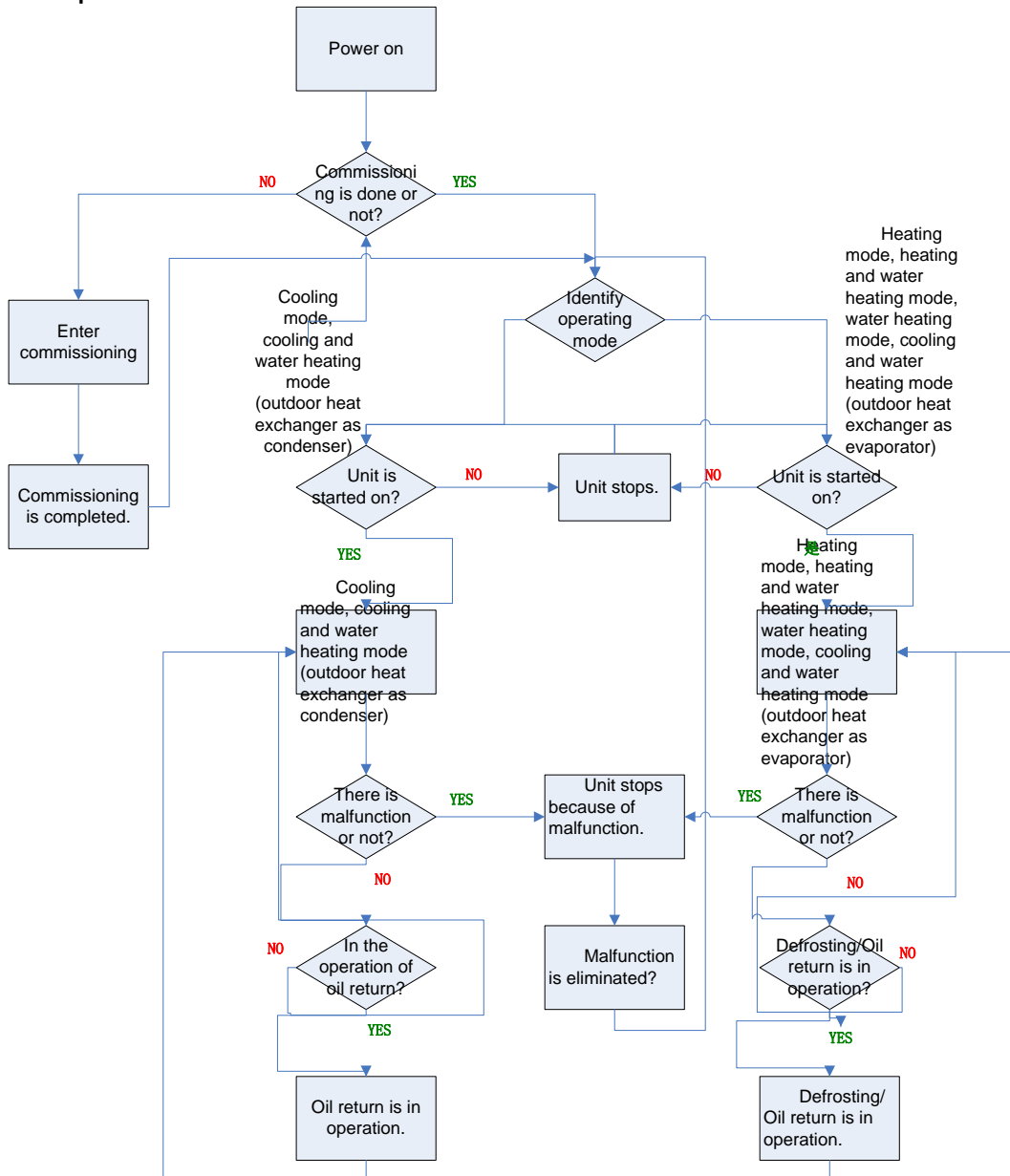

● Cooling Operation

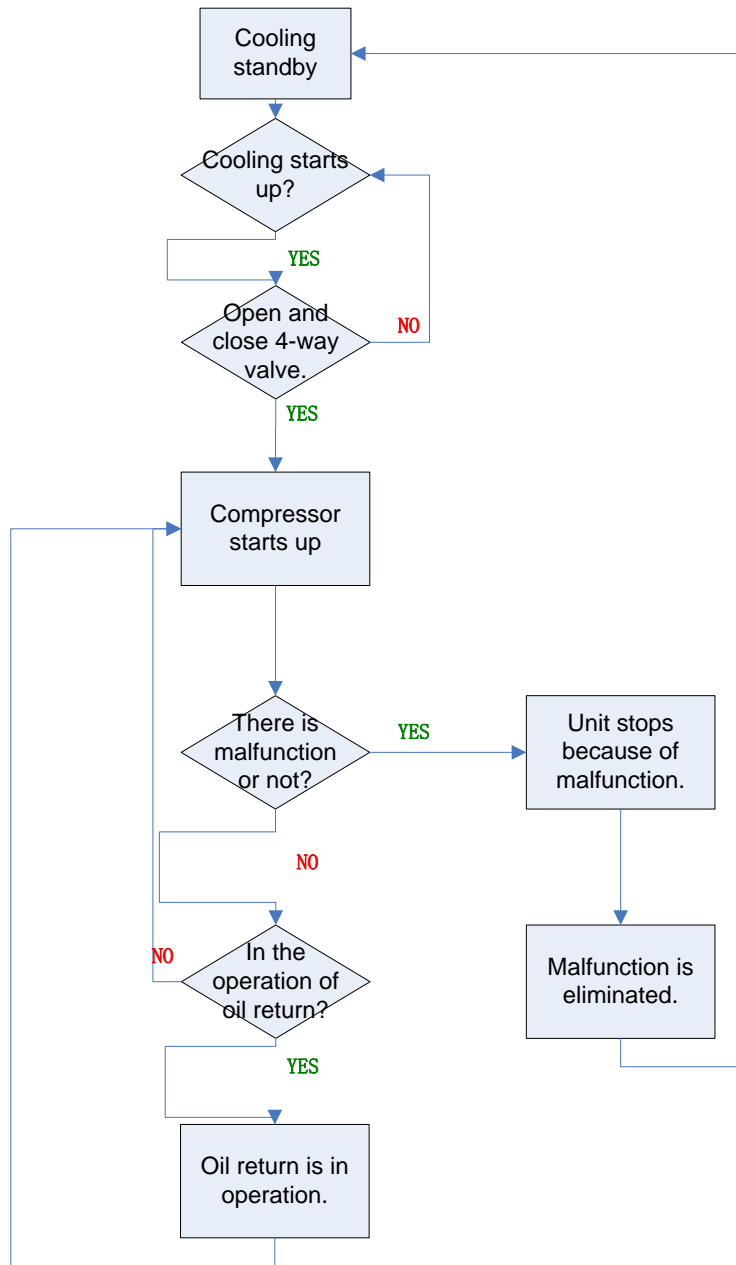

● Heating Operation

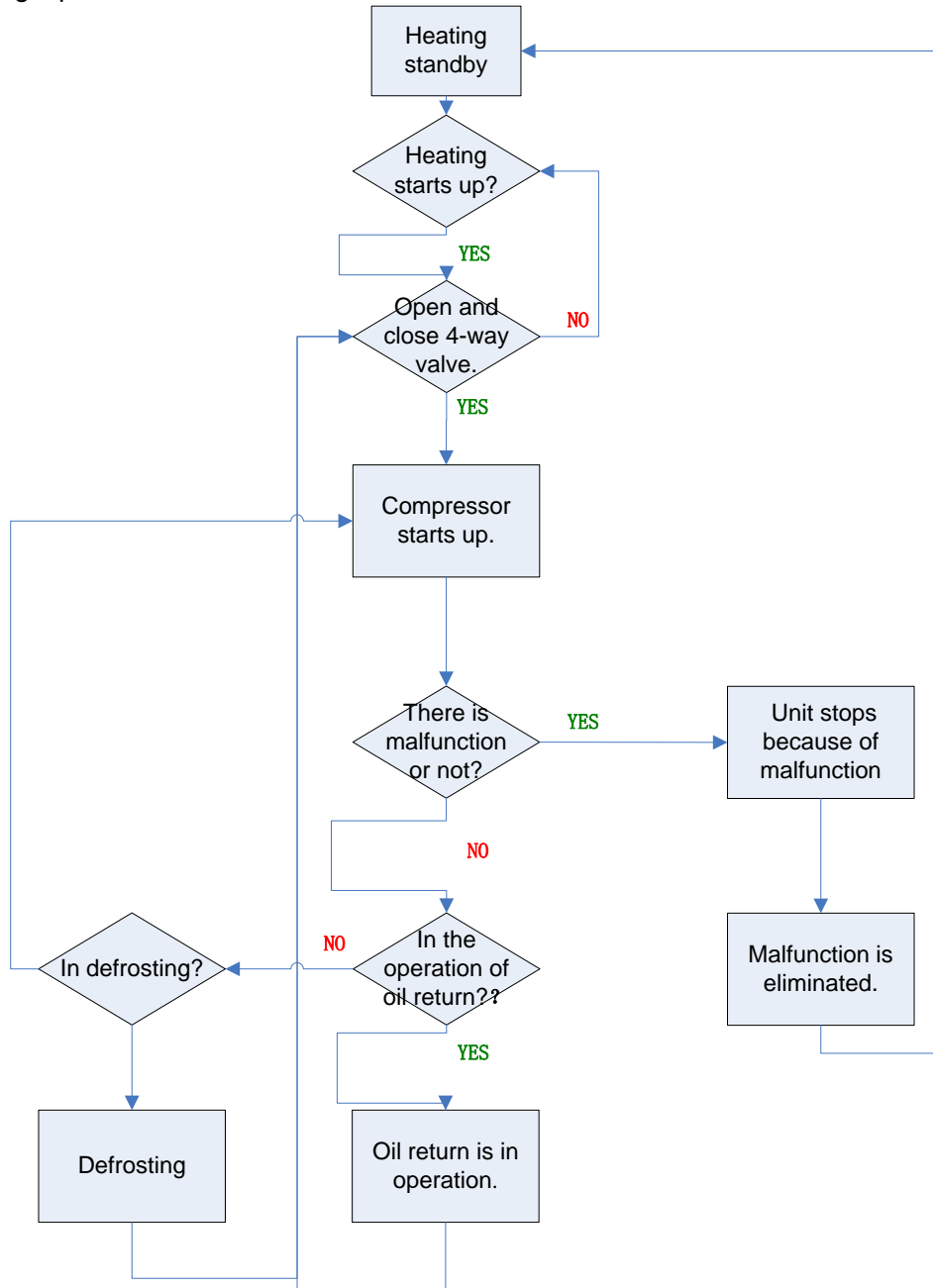

● Water Heating Operation

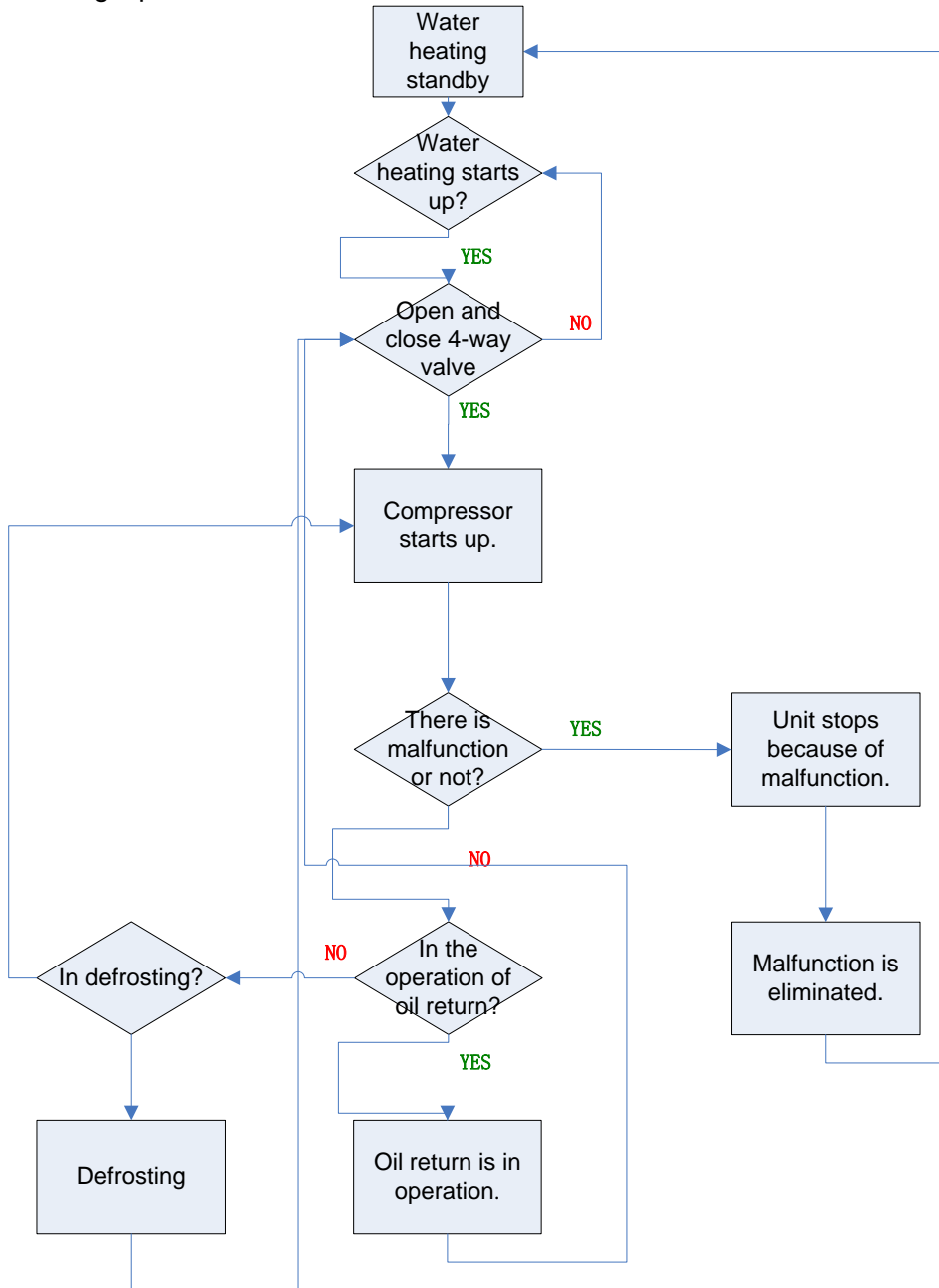

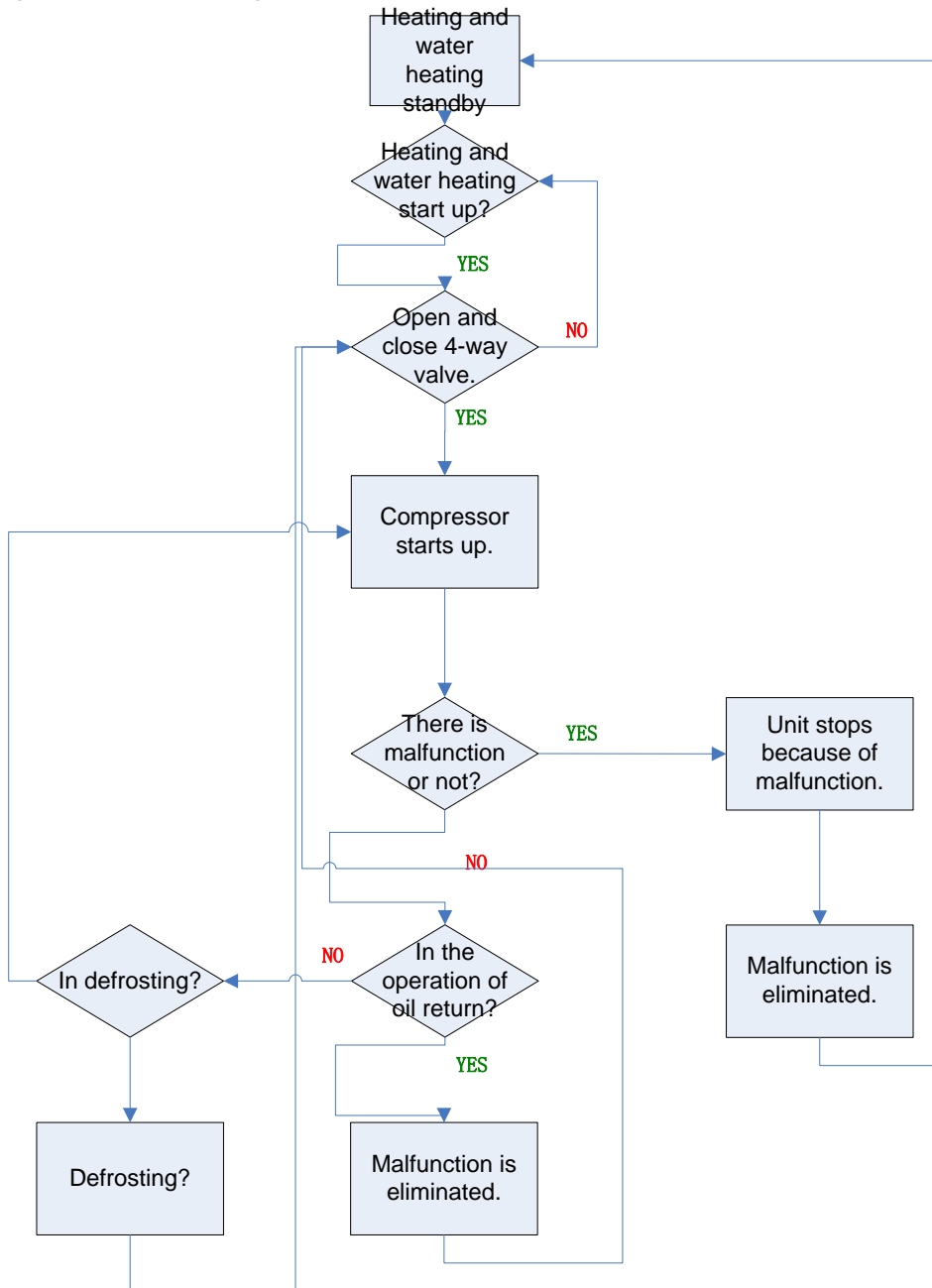

● Heating and Water Heating Operation



2. Remote Controller



No.	Button name	Function
1	ON/OFF	Turn on or turn off the unit
2	TURBO	Set turbo function
3	MODE	Set operation mode
4		Set up&down swing status
5	I FEEL	Set I FEEL function
6	TEMP	Switch temperature displaying type on the unit's display
7		Set health function and air function
8	LIGHT	Set light function
9	X-FAN	Set X-FAN function
10	SLEEP	Set sleep function
11	CLOCK	Set clock of the system
12	TOFF	Set timer off function

13	TON	Set timer on function
14		Set left&right swing status
15	FAN	Set fan speed
16	/	Set temperature and time

3. Indoor Unit Wired Controller

3.1 Display



Fig.1.1 Wired Controller

3.1.1 LCD of Wired Controller

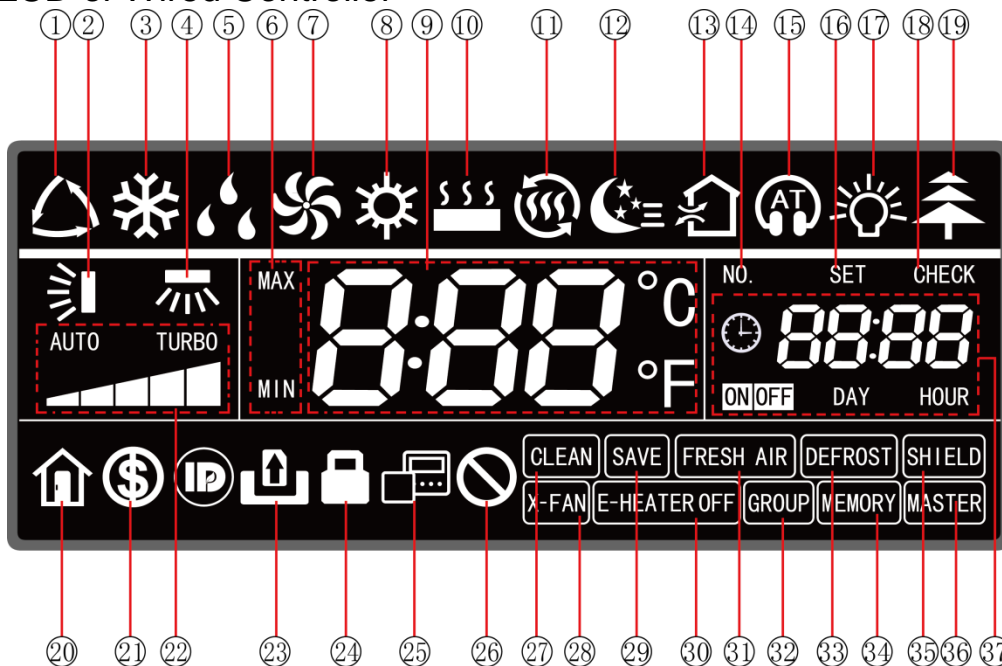

Fig.1.2 LCD Display of Wired Controller

3.1.2 LCD Display Instructions

Table 1.1 LCD Display Instructions

GMV5 Home DC Inverter Multi VRF Units

No.	Name	Instructions
1	Auto*	Auto mode (Under Auto mode, indoor units will automatically select their operating mode as per the temperature change so as to provide comfort.)
2	Up and down swing	Up and down swing function
3	Cooling	Cooling mode
4	Left and right swing*	Left and right swing function
5	Drying	Drying mode
6	Maximum and minimum temperature	It's valid under Save mode and displays during setting. Temperature lower limit for Cooling: Limit the minimum temperature value under Cooling or Drying mode. Temperature upper limit for Heating: Limit the maximum temperature value under Heating, 3D Heating, Warming mode.
7	Fan	Air supplying mode
8	Heating	Heating mode
9	Temperature zone	It shows the setting temperature value (If the wired controller controls a fresh air blower, it will show "FAP").
10	Floor heating*	Floor heating mode (When Heating and Floor Heating simultaneously show up, it indicates 3D Heating is activated.)
11	Warming*	Warming mode
12	Sleep	Sleep status
13	Air*	Air exchange status. It's an optional function for indoor unit.
14	No.	When inquiring or setting project number of indoor unit, it displays "No." icon.
15	Quiet	Quiet status (including Quiet and Auto Quiet modes)
16	Set	It displays "Set" icon under parameter setting interface.
17	Light	It is displayed when light board of indoor unit is on.
18	Check	It displays "Check" icon under parameter query interface.
19	Health*	It is displayed when Health function is set. It is an optional function for indoor unit.
20	Absence	It is displayed when Absence function is set.
21	Save	Indoor unit is running in an energy-saving mode.
22	Fan speed	It indicates the current set fan speed (including 7 types of speed: Auto, Low Speed, Medium-low Speed, Medium Speed, Medium-high Speed, High Speed and Turbo Speed)
23	Gate	Gate-control card is out.
24	Child lock	Child Lock status.
25	Slave wired controller	It indicates the current wired controller is a slave wired controller (address of wired controller is 02).
26	Invalid	It is displayed when operation is invalid.
27	Clean	Remind to clean the filter.
28	X-FAN	It is displayed when X-fan function is set.
29	Save	Outdoor unit is running in energy-saving mode/System capacity upper limit is less than 100%/Long-distance energy saving status
30	E-HEATER*	Allow auxiliary electric heating to be on.
31	Fresh air	Reserved
32	Group	It is displayed when one wired controller controls multiple indoor units.
33	Defrost	Outdoor unit is in defrosting status.
34	Memory	Memory status (Indoor unit resumes the original setting state after power is recovered from power failure).
35	Shield	Shielding status
36	Master	It is displayed when the current wired controller connects the master indoor unit.
37	Timer zone	It displays system clock and timer status.

Remark: When wired controller is connected with different indoor unit, some function will be different.

3.2 Buttons

3.2.1 Graphics of Buttons

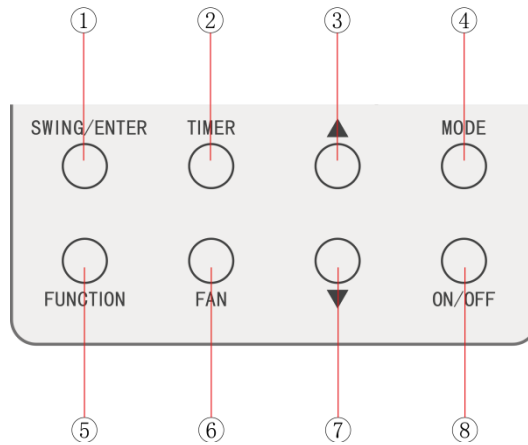

Fig.2.1 Graphics of Buttons

3.2.2 Function Instructions of Buttons

Table 2.1 Function Instructions of Buttons

No.	Name	Functions
1	Swing/Enter	(1) Set up & down swing function (2) Select and cancel function
2	Timer	Timer setting
3	Increase	(1) Set operating temperature of indoor unit (2) Set Timer
7	Decrease	(3) Switch among Quiet mode, Air grade, Clean grade and set the maximum and minimum temperature under Save mode. (4) Set and inquire parameters
4	Mode	Switch among Auto, Cooling, Drying, Fan, Heating, Floor Heating, 3D Heating and Warming modes. (Note: Floor Heating, 3D Heating and Warming will show up when the unit has those functions.)
5	Function	Switch among Air, Quiet, Light, Health, Absence, Save, Clean, E-heater and X-fan functions.
6	Fan	Switch among Auto, Low Speed, Medium-low Speed, Medium Speed, Medium-high Speed, High Speed and Turbo Speed.
8	On/Off	Indoor unit On/Off
3 + 7	Child lock	Press and hold Increase button and Decrease button for 5 seconds to enter or cancel Child Lock function.

3.3 Installation and Debugging of Wired Controller

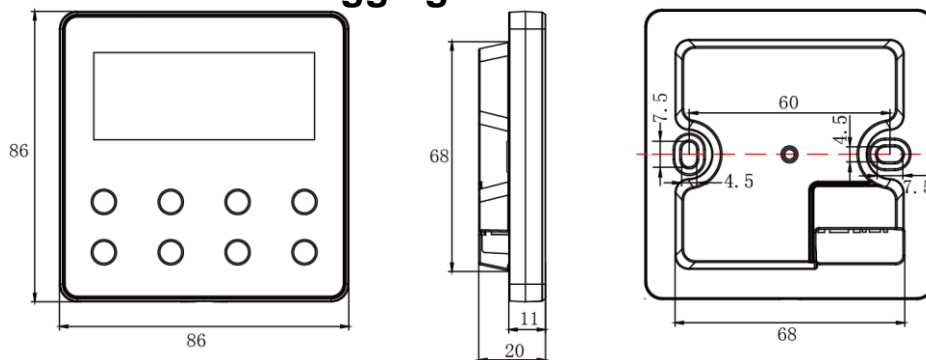

Fig.3.1 Dimension of Wired Controller

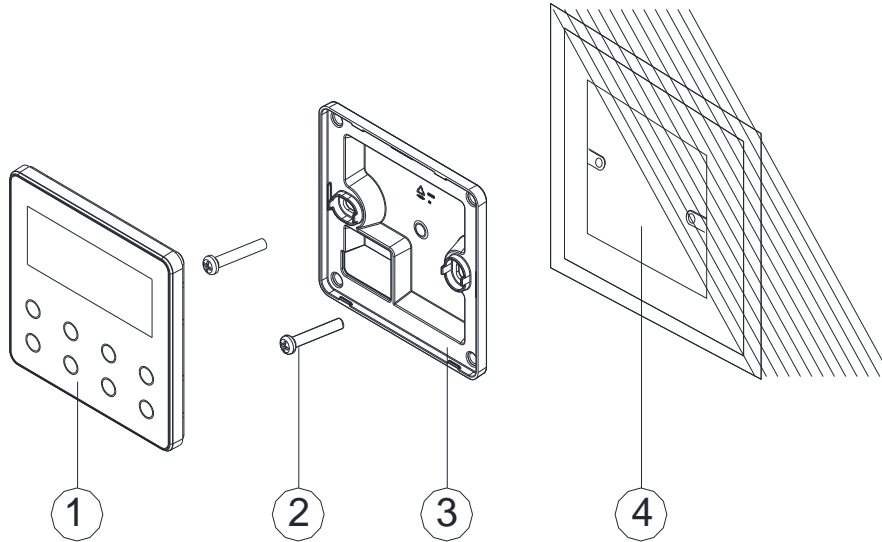

Fig.3.2 Parts of Wired Controller

No.	1	2	3	4
Name	Panel of wired controller	Screw M4X25	Soleplate of wired controller	Wiring box mounted in the wall
Quantity	1 pc	2 pc	1 pc	Prepared by user

3.3.1 Installation of Wired Controller

3.3.1.1 Selection of Communication Wire

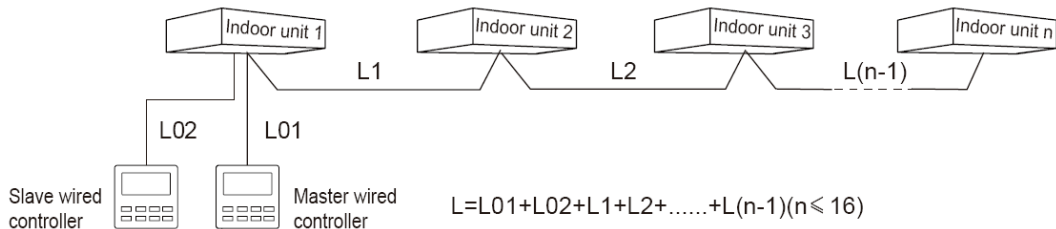

Fig.3.3 Length of Communication Wire

Wire material type	Total length of communication wire between indoor unit and wired controller L(m)	Wire size (mm ²)	Material standard	Remarks
Light/Ordinary polyvinyl chloride sheathed twisted copper cord (RVVS)	L≤250	2x0.75~ 2x1.25	GB/T 5023.5-2008	Total length of communication wire can't exceed 250m.
Shielding light/Ordinary polyvinyl chloride sheathed twisted copper cord (RVVSP)	L≤250	2x0.75~ 2x1.25	GB/T 5023.5-2008	If unit is installed in a place with strong electromagnetic interference, use shielding wire (RVVSP) as the communication wire of the wired controller.

△ Notice:

① If air conditioner is installed in a place with strong electromagnetic interference, communication wire of wired controller must be shielding twisted pair.

② Materials of communication wire for wired controller must be selected according to this manual strictly.

3.3.1.2 Installation Requirements

- (1) Never install the wired controller at wet places.
- (2) Never install the wired controller under direct sunlight.
- (3) Never install the wired controller at a place near high temperature objects or water-splashing places.
- (4) Never install the wired controller at a place that faces toward a window to prevent abnormal work due to the interference from other wired controllers around.

3.3.1.3 Wiring Requirements

There are four network wiring methods between wired controller and indoor unit:

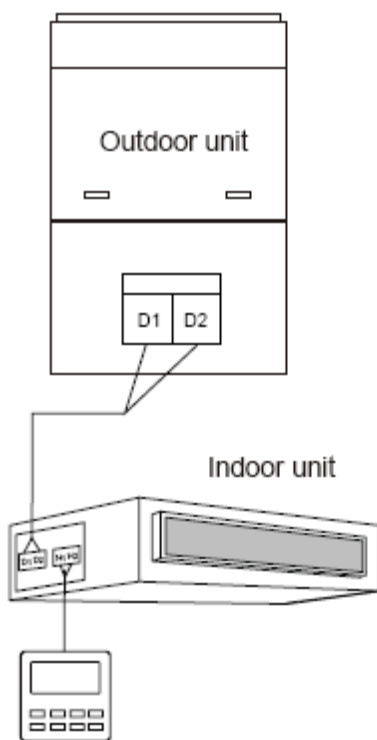

Fig.3.4 One Wired Controller Controls One Indoor Unit

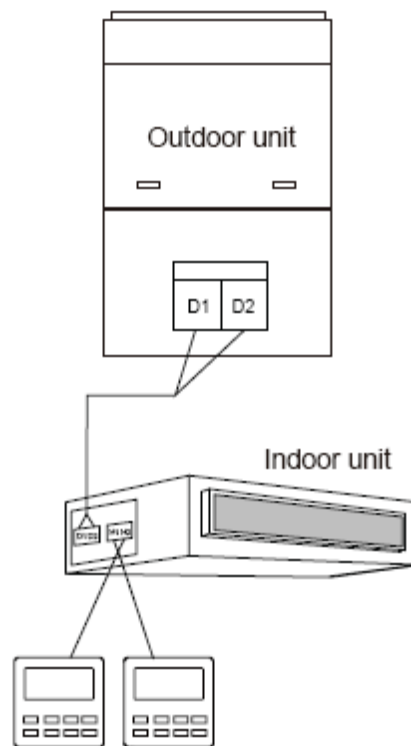

Fig.3.5 Two Wired Controllers Control One Indoor Unit

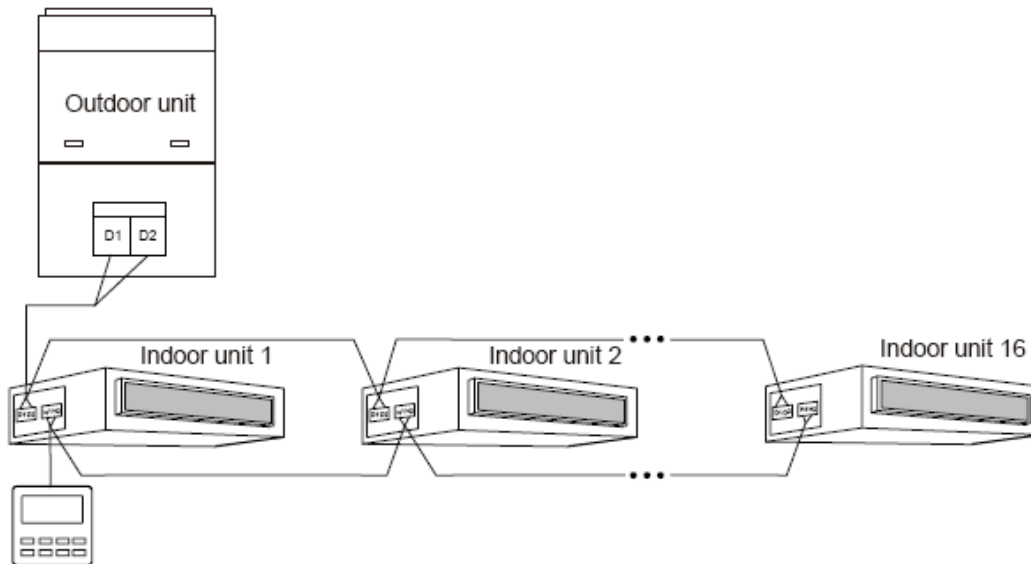

Fig.3.6 One Wired Controller Controls Multiple Indoor Units Simultaneously

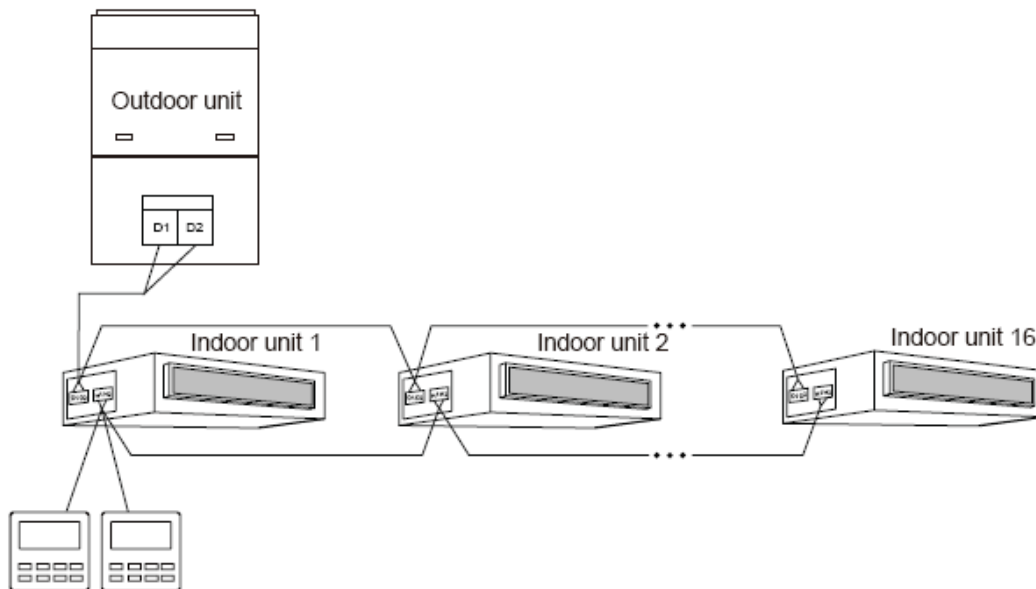

Fig.3.7 Two Wired Controllers Control Multiple Indoor Units Simultaneously

Wiring instructions:

- (1) When one wired controller controls multiple indoor units simultaneously, the wired controller can connect to any one indoor unit, but the connected indoor unit must be the same series indoor unit. The total quantity of indoor unit controlled by wired controller can't exceed 16 sets, and the connected indoor unit must be within the same indoor unit's network. Please refer to section 3.2.3 for the setting method.
- (2) When two wired controllers control one indoor unit, the addresses of those two wired controllers should be different. Please refer to section 3.2.3 for the setting method.
- (3) When two wired controllers control multiple indoor units, wired controller can connect to any one indoor unit, while the connected indoor unit should be the same series indoor unit. The addresses of those two wired controllers should be different. Please refer to section 3.2.3 for the setting method. The total quantity of indoor unit controlled by wired

controller can't be more than 16 sets and all connected indoor units must be within the same indoor unit network. Number of indoor units of group control must be set for wired controller. Please refer to section 3.2.3.

- (4) When one (or two) wired controller(s) control(s) multiple indoor units at the same time, the controlled indoor unit's setting should be the same.
- (5) Network wiring between wired controller and indoor unit must follow one of the four wiring methods as shown in Fig 3.4-3.7. As for the connection method shown in Fig 3.5 and 3.7, there should be only one master wired controller (address 01) and one slave wired controller (address 02). There can't be more than 2 wired controllers.

Note:

Series of indoor unit include: ①Common Multi VRF Indoor Units; ②Fresh Air Indoor Units; ③Double Heat Sources Indoor Units; ④Combining Type Indoor Units; Units except for fresh air units, double heat sources units, combining units are common multi VRF.

3.3.1.4 Installation

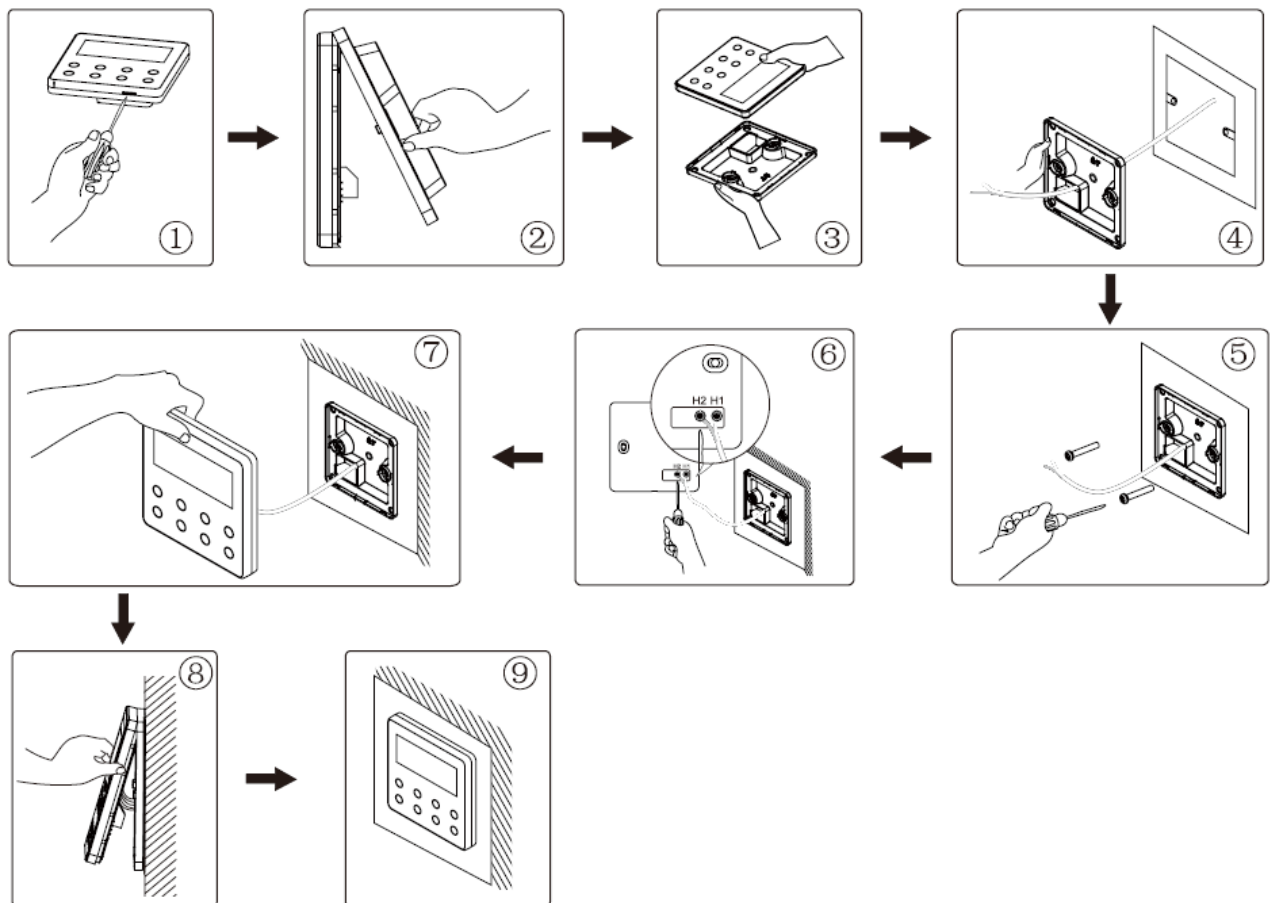

Fig.3.8 Installation of Wired Controller

Fig.3.8 is a simple installation process of wired controller. Please pay attention to the following matters:

- (1) Before installation, please cut off the power for indoor units.
- (2) Pull out the 2-core twisted pair from the installation hole on wall, and then pull this wire through the wiring hole at the rear side of the soleplate of wired controller.
- (3) Stick the soleplate of wired controller on the wall and use screw M4x25 to fix the soleplate onto the installation hole on wall.
- (4) Connect the 2-core twisted pair to H1 and H2 wiring column and then tighten up the screws.
- (5) Bundle the panel and soleplate of wired controller together.

3.3.1.5 Disassembly

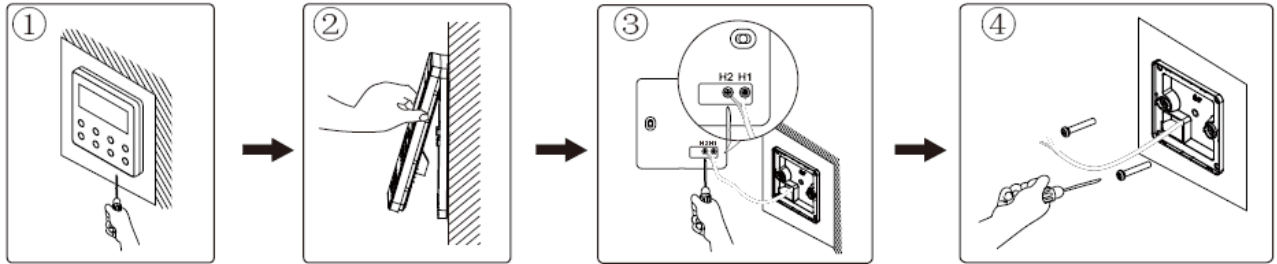

Fig.3.9 Disassembly of Wired Controller

3.3.2 Debugging

3.3.2.1 Set Master Indoor Unit

Under Off status, long press "MODE" button for 5s to set the corresponding indoor unit of wired controller as master indoor unit. When it is successfully set, "MASTER" icon will light up.

Note:

(1) If master indoor unit already exists in the network, you can also set the other unit to be a master unit. In this case, the original master unit will become slave unit.

(2) Only one master indoor unit is allowed in a network. If several units are set to be master units, system will automatically designate the unit with the smallest project number as master unit.

3.3.2.2 User Parameter Query

User parameters can be queried under power-on or power-off status.

- (1) Press and hold "FUNCTION" button for 5 seconds to enter the interface of user parameter query. "C00" is displayed in temperature zone and "Check" icon is on;
- (2) Press "▲" or "▼" button to select a parameter code.
- (3) Press "SWING/ENTER" button to return to the previous step until exiting the interface of parameter query.

The user parameter query list is as below:

Table 3.1 List of User Parameter Query

Parameter code	Parameter name	Parameter range	Query method
C00	Parameter setting ingress	-	<p>Display mode:</p> <p>Timer zone displays the project number of current indoor unit. Note: If current HBS network consists of several indoor units, then only the smallest project number will be shown.</p>
C01	Project number query of indoor unit and location of a faulty indoor unit	1-255: Project number of online indoor unit	<p>Operation method:</p> <p>Enter query: Press "MODE" button in "C01" status to enter the interface of indoor unit project number query. Press "▲" or "▼" button to select an indoor unit.</p> <p>Display mode:</p> <p>Temperature zone displays the error of the current indoor unit (If there are several errors, they are circularly displayed every 3 seconds).</p> <p>Timer zone displays (project number conflict C5 error) / project number of the current indoor unit (numbers are arranged from small to large).</p> <p>Special operation:</p> <p>After user presses the "MODE" button to enter project number</p>

GMV5 Home DC Inverter Multi VRF Units

			query, buzzer of the indoor unit operated by the wired controller will ring until user quits "C01" query or switches to the next indoor unit.
C03	Indoor unit quantity query in the system network	1-80	Timer zone displays the total number of indoor units in the system.
C06	Preferential operation query	00: Common operation 01: Preferential operation	<p>Operation method: In "C06" status, press "MODE" button to enter the interface of preferential operation query. Press "▲" or "▼" button to select an indoor unit.</p> <p>Display mode: Temperature zone displays the project number of current indoor unit. Timer zone displays the preferential operation setting value of current indoor unit.</p>
C07	Indoor ambient temperature query	-	<p>Operation method: In "C07" status, press "MODE" button to enter the interface of indoor ambient temperature query. Press "▲" or "▼" button to select an indoor unit.</p> <p>Display mode: Temperature zone displays the project number of current indoor unit Timer zone displays the temperature value of indoor ambient temperature sensor after replenishment.</p>
C08	Prompt time query for air filter cleaning	4-416: days	Timer zone displays the prompt time for air filter cleaning.
C09	Wired controller address query	01, 02	Timer zone displays the address of current wired controller.
C11	Indoor unit quantity query in the case that one wired controller controls many indoor units	1-16	Timer zone displays the total number of indoor units controlled by the wired controller.
C12	Outdoor ambient temperature query	-	Timer zone displays the temperature value of the ambient temperature sensor of master outdoor unit.
C17	Indoor relative humidity query	20~90	<p>Operation method: In "C17" status, press "MODE" button to enter the interface of indoor relative humidity query. Press "▲" or "▼" button to select an indoor unit.</p> <p>Display mode: Temperature zone displays the relative humidity value. Timer zone displays the project number of indoor unit (numbers are arranged from small to large). If HBS network consists of only one indoor unit, the timer zone will directly display the relative humidity value of that indoor</p>

GMV5 Home DC Inverter Multi VRF Units

			unit in the interface of "C17".
C18	Indoor unit project number query in the communication network	1~255	<p>Operation method ("C18" function is not available for slave wired controller):</p> <p>Setting: In "C18" status, press "MODE" button to enter the interface of indoor unit project code query. Press "▲" or "▼" button to select an indoor unit.</p> <p>Cancellation:</p> <p>① If user quits the "C18" query interface within 20 seconds, the project number display is cancelled.</p> <p>② If the query interface exits after 20 seconds upon time out, press "ON/OFF" button in power-on or power-off status to cancel the project number display.</p> <p>③ The method for cancelling the project number display on any wired controller in the network is the same as ②.</p> <p>Display mode:</p> <p>Temperature zone displays the number of current indoor unit (numbers are arranged from small to large).</p> <p>Timer zone displays the project number of indoor unit.</p> <p>Each indoor unit and wired controller in the network will display its own project number (Wired controller will display project numbers of indoor unit circularly every 3 seconds from small to large).</p>
C20	Fresh air indoor unit air discharge temperature query	-9~99	<p>Operation method:</p> <p>In "C20" status, press "MODE" button to enter the interface of fresh air indoor unit temperature query. Press "▲" or "▼" button to select an indoor unit.</p> <p>Display mode:</p> <p>Temperature zone displays the project number of current indoor unit (numbers 1~16 are arranged from small to large).</p> <p>Timer zone displays the air discharge temperature of fresh air indoor unit.</p> <p>If HBS network consists of only one indoor unit, the timer zone will directly display the air discharge temperature of that fresh air unit in the interface of "C20".</p>

Note:

- ① In parameter query status, "FAN" and "TIMER" buttons are invalid. By pressing "ON/OFF" button, user can return to the main interface but not power on or off the unit.
- ② In parameter query status, signals of remote controller are invalid.

3.3.2.3 User Parameter Settings

User parameters can be set in power-on or power-off status.

1. Press and hold "FUNCTION" button for 5 seconds, the temperature zone will display "C00". Then press and hold the "FUNCTION" button for another 5 seconds to enter the interface of wired controller parameter settings. Temperature zone will display "P00".
2. Select a parameter code by pressing "▲" or "▼". Press "MODE" button to switch to parameter value settings. The parameter value blinks. Adjust the parameter value by pressing "▲" or "▼". Then press "SWING/ENTER" button to complete the setting.

3. Press "SWING/ENTER" button to return to the previous step until exiting parameter settings.

The user parameter setting list is as below:

Table 3.2 List of User Parameter Settings

Parameter code	Parameter name	Parameter range	Default value	Remarks
P10	Setting of master indoor unit	00: No change to the current master/slave status of indoor units 01: Set the current indoor to be master indoor unit	00	After the indoor unit connected with the current wired controller is successfully set as master indoor unit, "MASTER" on the wired controller will be lit up.
P11	Infrared connection setting of wired controller	00: Disabled 01: Enabled	01	This setting can only be enabled through the master wired controller. When the infrared remote receiving function of wired controller is disabled, neither the master nor slave wired controller can receive remote signals. The wired controllers can only be operated by pressing.
P13	Wired controller address setting	01: Master wired controller 02: Slave wired controller	01	When two wired controllers simultaneously control one or more indoor units, the two wired controller should use different addresses. The slave wired controller (address: 02) doesn't have the function of unit parameter setting except the function of setting its own address.
P14	Quantity setting of group-controlled indoor units	00: Disabled 01-16: Number of indoor units	01	This value is set based on the number of connected indoor units. If the current value is inconsistent with the actual number of group-controlled indoor units, "L9" error will occur.
P30	Static pressure setting for indoor fan	Type 1: 03.04.05.06.07 Type 2: 01.02.03.04.05.06 .07.08.09	05	There are 2 types of indoor unit static pressure: 5 levels: 03, 04, 05, 06, 07 9 levels: 01, 02, 03, 04, 05, 06, 07, 08, 09 All wired controllers can set static pressure in level 1~9. When the indoor unit with 5 levels of static pressure receives signal from wired controller, signal of level 01, 02, 03 will be taken as level 03 and signal of level 07, 08, 09 will be taken as level 07 by the indoor unit.
P31	High ceiling installation	00: Standard height of ceiling installation	00	

GMV5 Home DC Inverter Multi VRF Units

		01: High height of ceiling installation		
P33	Setting of timer function	00: Common timing 01: Time-point timing	00	
P34	Effectiveness of repeated time-point timing	00: Single timing 01: Repeat every day	00	This setting is valid only when the timer function is set to time-point timing.
P37	Cooling temperature setting for auto mode	17°C~30°C	25	Cooling set temperature – Heating set temperature ≥1 Note: The two settings are still valid in remote shielding status.
P38	Heating temperature setting for auto mode	16°C~29°C	20	
P43	Setting of preferential operation	00: Common operation 01: Preferential operation	00	When power supply is insufficient, indoor units that are set with preferential operation can be turned on or off at will while other indoor units will be powered off forcibly. Error code will be displayed on the unit that is forcibly stopped.
P46	Clearing of accumulated time for air filter cleaning	00: Not cleared 01: Cleared	00	
P47	Setting of superfast defrosting	00: Common defrosting 01: Superfast defrosting 1 02: Superfast defrosting 2	00	Note: Superfast defrosting function is only applicable to models whose jumper cap is 10, 13, 14, 15, 16, 17, 18, 19, 20, 21, 22
P49	Setting of opening angle for indoor unit air return panel	01: Angle 1 (25°) 02: Angle 2 (30°) 03: Angle 3 (35°)	01	Only applicable to some models
P50	Setting of cooling air discharge temperature for fresh air indoor unit	16°C~30°C	18°C	Only applicable to fresh air indoor unit
P51	Setting of heating air discharge temperature for fresh air indoor	16°C~30°C	22°C	Only applicable to fresh air indoor unit

GMV5 Home DC Inverter Multi VRF Units

	unit			
P54	Setting of linkage for fresh air indoor unit	00: No linked control 01: Linked control	00	After linkage function is set, fresh air indoor unit will be powered on or off with the power-on or power-off of common indoor units. They can also be powered on or off manually. Note: This setting is only applicable to fresh air indoor unit.

Note:

In parameter setting status, "FAN" and "TIMER" buttons are invalid. By pressing "ON/OFF" button, user can return to the main interface but not power on or off the unit.

In parameter setting status, signals of remote controller are invalid.

3.3.2.4 Engineering Parameter Query

Engineering parameters can be queried in power-on or power-off status.

- (1) Press and hold "FUNCTION" button for 5 seconds to enter the interface of engineering parameter query. "C00" is displayed in temperature zone and "CHECK" icon is on;
- (2) After "C00" is displayed, continuously press "MODE" button for 3 times to enter engineering parameter query.
- (3) Press "▲" or "▼" button to select a parameter code.
- (4) Press "SWING/ENTER" button to return to the previous step until exiting parameter query.

In the engineering parameter query interface, user can also query user parameters as listed in table 3.1.

The list of engineering parameter query is as below:

Table 3.3 List of Engineering Parameter Query

Parameter code	Parameter name	Parameter range	Query method
C00	Parameter setting ingress (default)	-	Display mode: Timer zone displays the project number of the current indoor unit. Note: If the current HBS network consists of several indoor units, only the indoor unit that has the smallest project number is displayed.
C02	Indoor unit capacity query	-	Operation method: In "C02" status, press "MODE" button to enter the interface of preferential operation query. Press "▲" or "▼" to switch the project number of indoor unit. Display mode: Temperature zone displays the project number of the current indoor unit. Timer zone displays the current indoor unit capacity/ indoor unit capacity after adjustment.

GMV5 Home DC Inverter Multi VRF Units

C04	Project number query of master indoor unit	1-255:Project number; 00: No master indoor unit	Timer zone displays the project number of master indoor unit/ 00.
C05	Historical error query ingress of indoor unit	5 historical errors	<p>Operation method:</p> <p>1. In "C05" status, press "MODE" button to enter the historical error query interface. Press "▲" or "▼" to switch the project number of indoor unit. Press "MODE" button to enter error code query of the current indoor unit. Press "▲" or "▼"to switch the error number. Press "SWING/ENTER" button to return to the upper-level menu.</p> <p>Display mode:</p> <p>Temperature zone displays the error number and error code. Timer zone displays the project number of indoor unit.</p>
C10	Static pressure setting query of outdoor unit	00: 0Pa 20: 20Pa 50: 50Pa 80: 80Pa	<p>Operation method:</p> <p>In "C10" status, press "MODE" button to enter the interface of outdoor unit static pressure setting query. Press "▲" or "▼" button to switch the outdoor unit address.</p> <p>Display mode:</p> <p>Temperature zone displays the address of the current outdoor unit. Timer zone displays the static pressure setting value.</p>
C13	Outdoor unit network number query	1~255	Timer zone displays the network number of the current outdoor unit.
C14	Temperature query for inlet tube temperature sensor of indoor unit	-9~99	<p>Operation method:</p> <p>In "C14" status, press "MODE" button to enter the interface of indoor unit inlet tube temperature sensor query. Press "▲" or "▼" button to switch the number of indoor unit.</p> <p>Display mode:</p> <p>Temperature zone displays the project number of the current indoor unit. Timer zone displays the temperature value.</p> <p>If the HBS network consists of only one indoor unit, timer zone will directly display the temperature value in "C14" status. Temperature is displayed in Centigrade whether the remote signal is Fahrenheit or Centigrade.</p> <p>When the wired controller displays the inlet tube temperature after receiving signals from the remote controller, the inlet tube temperature of the indoor unit that has the smallest project number in the HBS network is displayed by default.</p>
C15	Temperature query for outlet tube	-9~99	<p>Operation method:</p> <p>In "C15" status, press "MODE" button to enter the interface of indoor unit outlet tube temperature sensor query. Press "▲" or "▼" button</p>

GMV5 Home DC Inverter Multi VRF Units

	temperature sensor of indoor unit		<p>to switch the number of indoor unit.</p> <p>Display mode:</p> <p>Temperature zone displays the project number of the current indoor unit.</p> <p>Timer zone displays the temperature value.</p> <p>If the HBS network consists of only one indoor unit, timer zone will directly display the temperature value in "C15" status.</p> <p>Temperature is displayed in Centigrade whether the remote signal is Fahrenheit or Centigrade.</p> <p>When the wired controller displays the outlet tube temperature after receiving signals from the remote controller, the outlet tube temperature of the indoor unit that has the smallest project number in the HBS network is displayed by default.</p>
C16	Opening degree query of electronic expansion valve of indoor unit	0~20	<p>Operation method:</p> <p>In "C16" status, press "MODE" button to enter the interface of indoor unit electronic expansion valve opening degree query. Press "▲" or "▼" button to switch the number of indoor unit.</p> <p>Display mode:</p> <p>Temperature zone displays the project number of the current indoor unit.</p> <p>Timer zone displays the opening degree value.</p> <p>If the HBS network consists of only indoor unit, timer zone will directly display the opening degree value of electronic expansion valve in the "C16" status.</p> <p>When the wired controller displays the opening degree of electronic expansion valve after receiving signals from remote controller, the opening degree of electronic expansion valve of the indoor unit that has the smallest project number in the HBS network is displayed.</p>
n2	Capacity configuration ratio upper limit of outdoor/indoor unit	35:135% 50:150%	<p>Temperature zone displays parameter code.</p> <p>Timer zone displays the setting value of capacity configuration ratio of the current outdoor/indoor unit.</p>
n6	Historical error query ingress of outdoor unit	5 historical errors	<p>Operation method:</p> <p>In "n6" status, press "MODE" button to enter the query of outdoor unit error code (If the wired controller controls multiple indoor units, only the errors memorized by the indoor unit that has the smallest project number can be queried). Press "▲" or "▼" button to switch the error number. Press "SWING/ENTER" button to return to the upper-level menu.</p> <p>Display mode:</p> <p>Temperature zone displays the error number and error code from left to right (1~5, errors are arranged from the earliest to the latest).</p> <p>Timer zone displays the project code of outdoor unit.</p>
n7	Parameter	01~13	Operation method (n7 query is not supported by slave wired

GMV5 Home DC Inverter Multi VRF Units

	query ingress of outdoor unit	25~29	<p>controller):</p> <p>In "n7" status, the timer zone is not displayed. Press "MODE" button to enter parameter query of outdoor unit. The first bit in the temperature zone (display bit of the outdoor unit module ID) blinks. Press "▲" or "▼" to switch the outdoor unit module ID. Press "MODE" button to select an outdoor unit module. In this case, the first bit in the temperature zone stops blinking, and the second and third bits in the temperature zone display the parameter code. The timer zone displays a corresponding parameter value. Press "▲" or "▼" to switch the parameter code and press the "SWING/ENTER" button to return to the upper-level menu.</p> <p>Display mode:</p> <p>Temperature zone displays the outdoor unit module ID and parameter code from left to right.</p> <p>Timer zone displays a corresponding parameter value on the right.</p> <table border="1" data-bbox="746 772 1321 2056"> <thead> <tr> <th>Parameter code</th> <th>Parameter name</th> <th>Unit</th> </tr> </thead> <tbody> <tr> <td>01</td> <td>Outdoor ambient temperature</td> <td>°C/°F</td> </tr> <tr> <td>02</td> <td>Operation frequency of compressor 1</td> <td>Hz</td> </tr> <tr> <td>03</td> <td>Operation frequency of compressor 2</td> <td>Hz</td> </tr> <tr> <td>04</td> <td>Operation frequency of outdoor fan</td> <td>Hz</td> </tr> <tr> <td>05</td> <td>Module high pressure</td> <td>°C/°F</td> </tr> <tr> <td>06</td> <td>Module low pressure</td> <td>°C/°F</td> </tr> <tr> <td>07</td> <td>Discharge temperature of compressor 1</td> <td>°C/°F</td> </tr> <tr> <td>08</td> <td>Discharge temperature of compressor 2</td> <td>°C/°F</td> </tr> <tr> <td>09</td> <td>Discharge temperature of compressor 3</td> <td>°C/°F</td> </tr> <tr> <td>10</td> <td>Discharge temperature of compressor 4</td> <td>°C/°F</td> </tr> <tr> <td>11</td> <td>Discharge temperature of compressor 5</td> <td>°C/°F</td> </tr> <tr> <td>12</td> <td>Discharge temperature of compressor 6</td> <td>°C/°F</td> </tr> <tr> <td>13</td> <td>Operation frequency of compressor 3</td> <td>Hz</td> </tr> <tr> <td>25</td> <td>Outdoor unit heating EXV1 (Actual value = Displayed value*10)</td> <td>PLS</td> </tr> <tr> <td>26</td> <td>Outdoor unit heating EXV2</td> <td>PLS</td> </tr> </tbody> </table>	Parameter code	Parameter name	Unit	01	Outdoor ambient temperature	°C/°F	02	Operation frequency of compressor 1	Hz	03	Operation frequency of compressor 2	Hz	04	Operation frequency of outdoor fan	Hz	05	Module high pressure	°C/°F	06	Module low pressure	°C/°F	07	Discharge temperature of compressor 1	°C/°F	08	Discharge temperature of compressor 2	°C/°F	09	Discharge temperature of compressor 3	°C/°F	10	Discharge temperature of compressor 4	°C/°F	11	Discharge temperature of compressor 5	°C/°F	12	Discharge temperature of compressor 6	°C/°F	13	Operation frequency of compressor 3	Hz	25	Outdoor unit heating EXV1 (Actual value = Displayed value*10)	PLS	26	Outdoor unit heating EXV2	PLS
Parameter code	Parameter name	Unit																																																	
01	Outdoor ambient temperature	°C/°F																																																	
02	Operation frequency of compressor 1	Hz																																																	
03	Operation frequency of compressor 2	Hz																																																	
04	Operation frequency of outdoor fan	Hz																																																	
05	Module high pressure	°C/°F																																																	
06	Module low pressure	°C/°F																																																	
07	Discharge temperature of compressor 1	°C/°F																																																	
08	Discharge temperature of compressor 2	°C/°F																																																	
09	Discharge temperature of compressor 3	°C/°F																																																	
10	Discharge temperature of compressor 4	°C/°F																																																	
11	Discharge temperature of compressor 5	°C/°F																																																	
12	Discharge temperature of compressor 6	°C/°F																																																	
13	Operation frequency of compressor 3	Hz																																																	
25	Outdoor unit heating EXV1 (Actual value = Displayed value*10)	PLS																																																	
26	Outdoor unit heating EXV2	PLS																																																	

GMV5 Home DC Inverter Multi VRF Units

					(Actual value = Displayed value*10)											
				27	Sub-cooler EXV (Actual value = Displayed value*10)	PLS										
				28	Defrosting temperature	°C/°F										
				29	Liquid-extracting temperature of sub-cooler	°C/°F										
				30	Outlet tube temperature of gas separator	°C/°F										
				31	Oil return temperature	°C/°F										
				32	Inlet tube temperature of condenser	°C/°F										
				33	Outlet tube temperature of condenser	°C/°F										
A6	Unit cooling/heating function	nA: Cooling/ Heating nC: Cooling only nH: Heating only nF: Fan (air supply)	Temperature zone displays the parameter code. Timer zone displays the cooling/heating function setting value of the current unit.													
nb	Barcode query of indoor unit	0~9, A~Z, a~z,-	<p>Operation method (nb query is not supported by slave wired controller):</p> <p>In “nb” status, the timer zone is not displayed. Press “MODE” button to enter barcode query. The temperature zone displays “nb” and the project number in the timer zone blinks. Press “▲” or “▼” to switch the project number of indoor unit.</p> <p>Press “MODE” button to select an indoor unit. The temperature zone displays “Un” and the timer zone displays “-n”. Press “▲” or “▼” to display the barcode of the entire indoor unit and the barcode of indoor unit controller. Press “SWING/ENTER” button to return to the upper-level menu. The temperature zone displays “nb” and the timer zone displays the project number of the queried indoor unit. Press “SWING/ENTER” button again to return to the upper-level menu.</p> <p>Display mode:</p> <p>Temperature zone displays nb/Un/Pc/barcode. Timer zone displays -n/project number/barcode.</p> <p>The following is an example:</p> <table border="1"> <thead> <tr> <th>Example</th> <th>Temperature zone</th> <th>Timer zone</th> <th>Remark 1</th> <th>Remark2</th> </tr> </thead> <tbody> <tr> <td>Barcode of the entire indoor unit: N1r0128150066</td> <td>Un (displayed on the right)</td> <td>-n (displayed in the middle)</td> <td>It indicates that the following is the</td> <td>Press “▼” to display downward and press</td> </tr> </tbody> </table>				Example	Temperature zone	Timer zone	Remark 1	Remark2	Barcode of the entire indoor unit: N1r0128150066	Un (displayed on the right)	-n (displayed in the middle)	It indicates that the following is the	Press “▼” to display downward and press
Example	Temperature zone	Timer zone	Remark 1	Remark2												
Barcode of the entire indoor unit: N1r0128150066	Un (displayed on the right)	-n (displayed in the middle)	It indicates that the following is the	Press “▼” to display downward and press												

GMV5 Home DC Inverter Multi VRF Units

					barcode of the entire indoor unit.	"▲" to display upward.
			N1r	0128	It indicates the former 7 bits of the barcode	
			150	066	It indicates the latter 6 bits of the barcod.	
		Barcode of indoor unit controller: N1r012815006 7	Pc	-n	It indicates that the following is the barcode of indoor unit controller	
			N1r	0128	It indicates the former 7 bits of the barcode	
			150	067	It indicates the latter 6 bits of the barcode	
Note:						
<p>1. Un indicates the barcode of the entire indoor unit; Pc indicates the barcode of indoor unit controller.</p> <p>2. When there is only one indoor unit, press "MODE" button in "nb" status to enter barcode query. There is no need to select project number of indoor unit.</p> <p>3. System will exit the query status if no operation is performed within 60 seconds.</p> <p>4. The barcode query starts from the barcode of the entire indoor unit and ends at the barcode of indoor unit controller. That is, the query does not start again even if user presses "▼".</p>						

Note:

In parameter query status, "Fan" and "Timer" buttons are invalid. By pressing "ON/OFF" button, user can return to the main interface but not power on or off the unit.

In parameter query status, signals of remote controller are invalid.

3.3.2.5 Engineering Parameter Settings

Engineering parameters can be set in power-on or power-off status.

- (1) Press and hold "FUNCTION" button for 5 seconds and the temperature zone displays "C00". Continue to press "MODE" button for 3 times, and then press and hold "FUNCTION" button for 5 seconds to enter the interface of engineering parameter settings. The temperature zone will display "P00".
- (2) Press "▲" or "▼" button to select a parameter code. Press "MODE" button to switch to parameter value settings. The parameter value blinks. Adjust the parameter value by pressing "▲" or "▼" button, then press "SWING/ENTER" button to complete the setting.
- (3) Press "SWING/ENTER" button to return to the previous step until exiting parameter settings.

In the interface of engineering parameter settings, user can also set user parameters as listed in table 3.2.

The engineering parameter setting list is as below:

Table 3.4 List of Engineering Parameter Settings

Parameter code	Parameter name	Parameter range	Default value	Remarks
P15	Power-off memory mode	00: Standby after recovery from power disconnection 01: Restore the original status after recovery from power disconnection	00	
P17	Historical error clearing for indoor unit	00: Not cleared 01: Cleared	00	It is to clear historical errors of all indoor units controlled by the current wired controller.
P20	Setting of indoor unit ambient temperature sensor	01: Temperature sensor of air return vent; 02: Temperature sensor of wired controller; 03: Temperature sensor of air return vent for cooling, drying and fan mode; Temperature sensor of wired controller for heating; 04: Temperature sensor of wired controller for cooling, drying and fan mode; Temperature sensor of air return vent for heating	03	When there are master and slave wired controllers and the temperature sensor of wired controller is used, only the temperature sensor of the master wired controller is used by default. Note: 1. In auto mode, ambient temperature sensor setting is invalid for a common indoor unit but the setting value is memorized. 2. The ambient temperature sensor setting is invalid for a fresh air indoor unit. The temperature sensor of air return vent is used by default.
P21	Corrected value	-15~+15	Temperature	Press "▲" or "▼" to increase or

GMV5 Home DC Inverter Multi VRF Units

	of ambient temperature sensor of indoor unit(for cooling, drying and fan mode)		sensor of unit: 0°C; Temperature sensor of wired controller: 0°C	decrease by 1°C.
P22	Corrected value of ambient temperature sensor of indoor unit (for heating, fast heating and warming mode)	-15~+15	Temperature sensor of unit: -2°C; Temperature sensor of wired controller: 0°C	Press “▲” or “▼” to increase or decrease by 1°C. Temperature sensor of the unit and the temperature sensor of wired controller share the same corrected value. In heating mode, corrected value of temperature sensor of unit = corrected value of temperature sensor of wired controller -2°C.
P32	Capacity adjustment function of indoor unit	-40%~+40%	00	Press “▲” or “▼” to increase or decrease by 10%.
P35	Factory setting recovery for user functions	00: Invalid 01: Valid	00	Select "01" and then press and hold "SWING/ENTER" button to restore the factory settings for user functions (Factory setting recovery will fail if remote shield is effective).
P36	Factory setting recovery for engineering settings	00: Invalid 01: Valid	00	Select "01" and then press and hold "SWING/ENTER" button to restore the factory settings for engineering settings (Factory setting recovery will fail if remote shield is effective).
P40	Prevention for heat collection	00: Disabled 10: 10 seconds 20: 20 seconds 30: 30 seconds 40: 40 seconds 50: 50 seconds 60: 60 seconds	00	It indicates the number of seconds for enabling the low-level fan every 15 minutes.
P42	Setting of indoor unit project number	1~255	Automatically generated upon the initial system operation	In "P42" status, press "MODE" button to enter the setting menu. The project number blinks in the timer zone. Press “▲” or “▼” to adjust the project number. Press "SWING/ENTER" button to confirm the setting and return to

GMV5 Home DC Inverter Multi VRF Units

				the upper-level menu.
P45	One-key reset for indoor unit project number	00: Invalid 01: Valid	00	When it is set to 01, the wired controller initiates an indoor unit project number reset command.
P48	Minimum opening degree setting for heating breakdown of indoor unit expansion valves	00: Automatically controlled Adjustable in 1~500	00	After the default minimum opening degree for heating breakdown is manually modified, the opening degree remains unchanged upon heating breakdown.
P52	Setting of indoor fan speed in AHRI energy efficiency test mode	100~1800	-	<p>Operation method:</p> <p>In "P52" status, timer zone displays the actual speed of AHRI indoor fan.</p> <p>Press "MODE" button to enter the interface of settings. Timer zone displays the targeted speed of indoor fan and blinks. Press "▲" or "▼" to adjust the setting of indoor fan speed. Press and hold for 5 seconds, fan speed will increase one digit by one digit. Press and hold for 5~10 seconds, fan speed will increase two digits by two digits. The adjustment range can't exceed the maximum and minimum value of indoor unit. Press "SWING/ENTER" button to confirm the setting and return to the upper-level menu.</p> <p>Display mode:</p> <p>Temperature zone displays P52. Timer zone displays the indoor fan speed.</p> <p>Note: If one wired controller controls many indoor units, only the actual fan speed of the indoor unit that has the smallest project number will be displayed. Fan speed cannot be set.</p>
P53	Setting of water pump status in special	00: Water pump is not allowed to be on 01: Water pump is	01	If it is set to 00, water pump is not allowed to be on in special operating mode (capacity test

GMV5 Home DC Inverter Multi VRF Units

	operating mode	allowed to be on		mode, energy efficiency test mode, AHRI test mode); If it is set to 01, water pump works as normal.
P55	Setting of static pressure for DC fresh air unit	Setting range: 01, 02, 03, 04, 05, 06, 07, 08, 09, 10, 12, 13	08	There are 13 levels of static pressure of DC fresh air unit. Each level is corresponding to a speed value. After adjusting fan speed at the main interface of wired controller, motor speed remains unchanged. Motor speed can be changed by setting the static pressure level upon entering wired controller functions.
n0	Setting of system energy-saving operation	00: Pleasantness in priority 01: Energy-saving in priority	00	
n1	Setting of defrosting period	40: 40 minutes 50: 50 minutes 60: 60 minutes	50	
n3	Forcible defrosting	00: Common 01: Forcible defrosting	00	After setting is finished, it automatically restores to "00".
n4	Setting of the highest capacity output limitation for outdoor unit	08: 80% 09: 90% 10: 100%	10	Enter query in "n4" status. Temperature zone displays the function code and timer zone displays the corresponding setting value.
A7	Quiet function for outdoor unit	00: No quiet function 01~09: Intelligent nighttime quiet mode 1 to mode 9 10~12: Forcible quiet mode 1 to mode 3	00	Enter query in "A7" status. Temperature zone displays the function code and timer zone displays the corresponding setting value.

Note:

- (1) In parameter setting status, "Fan" and "Timer" buttons are invalid. By pressing "ON/OFF" button, user can return to the main interface but not power on or off the unit.
- (2) In parameter setting status, signals of remote controller are invalid.

4. Hydro Box Wired Controller

4.1 Display



4.1.1 LCD of Wired Controller

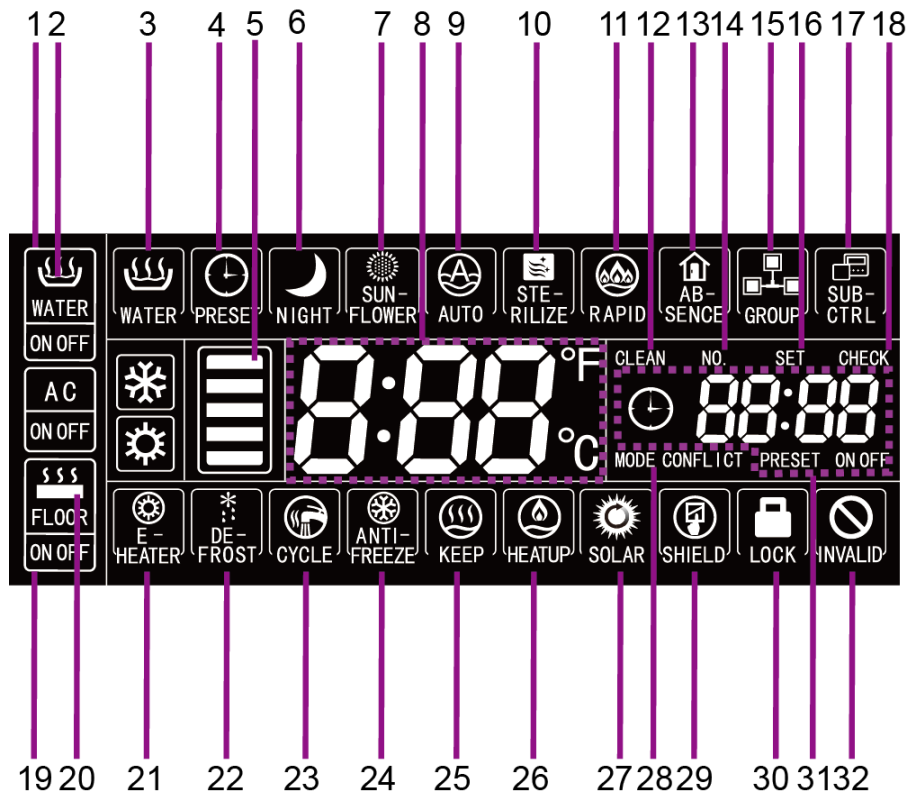

4.1.2 LCD Display Instructions

No.	Name	Instructions
1	Water heating	When wired controller displays water heating function, the corresponding frame will be lit up.

GMV5 Home DC Inverter Multi VRF Units

2	Water heating on/off	The icon of hot water is lit up. Icon of on/off will be displayed along with the on/off of water heating.
3	Standard water heating	Standard water heating
4	Preset	Preset water heating
5	Usable hot water	It indicates the percentage of usable hot water. It is displayed only on water heating interface.
6	Night	Nighttime water heating
7	Sunflower	It is displayed when sunflower function is activated.
8	Temperature zone	It displays set water temperature/ actual water temperature
9	Auto	It is displayed when water temperature is set automatically. Auto mode can be set in water heating or floor heating. It will be on or off along with the on or off of the corresponding function.
10	Sterilize	It is lit up when high temperature sterilization is effective. It blinks when sterilization is in process.
11	Rapid	It is displayed when rapid function is effective. Rapid function can be set in water heating and floor heating. It will be on or off along with the on or off of the corresponding function.
12	Clean	It is displayed when cleaning function is effective. It blinks when cleaning is in process.
13	Absence	It is displayed when absence function is effective.
14	No.	"No." icon is displayed when checking or setting the project number of hydro box.
15	Group control	It is displayed when one wired controller controls multiple hydro boxes.
16	Set	"Set" icon is displayed when wired controller is in the interface of parameter setting.
17	Sub-controller	It indicates that the current wired controller is a slave controller (address: 02).
18	Check	"Check" icon is displayed when wired controller is in the interface of parameter query.
19	Floor heating	When wired controller displays floor heating function, the corresponding frame will be lit up.
20	Floor heating on/off	The icon of floor heating is lit up. Icon of on/off will be displayed along with the on/off of floor heating.
21	E-heater	It indicates that auxiliary electric heating is on.
22	Defrost	It indicates outdoor unit is in defrosting process.
23	Cycle	It indicates the running state of cycle pump.
24	Antifreeze	It indicates the anti-freezing state.
25	Keep water temperature	It indicates a running state of hydro box.
26	Heat up	It indicates a running state of hydro box.
27	Solar power	It blinks when hydro box is connected with solar power.
28	Mode conflict	If unit is in cooling/ drying mode, floor heating is not allowed to be on. In this case, "Mode conflict" blinks.
29	Shield	Shielding state
30	Child lock	Child lock state

GMV5 Home DC Inverter Multi VRF Units

31	Timer zone	It displays system clock and timer state.
32	Invalid	It is displayed when operation is invalid.
Remark: Functions may vary if wired controller matches with a different hydro box.		

4.2 Buttons

4.2.1 Graphics of Buttons

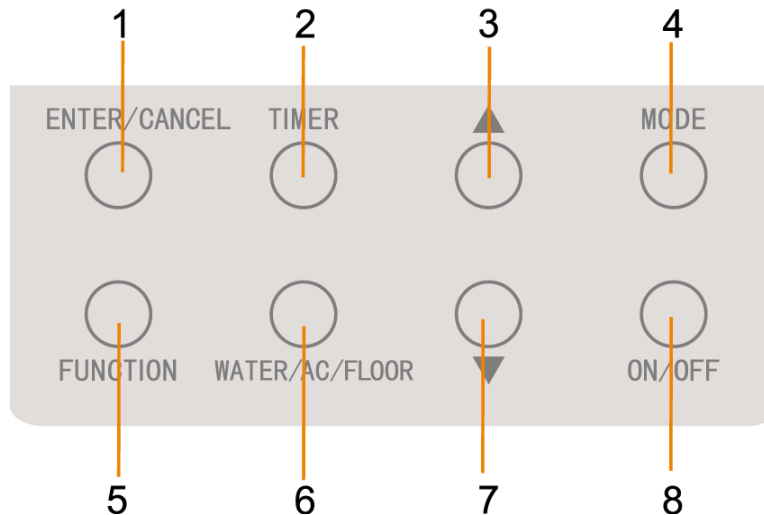

4.2.2 Function Instructions of Buttons

No.	Name	Functions
1	Enter/Cancel	Select or cancel a function
3	Decrease	(1) Set water temperature of water heating, water temperature of floor heating, temperature of high temperature sterilization; (2) Set timer (for water heating/ floor heating), preset water heating time, time of high temperature sterilization; (3) Set and inquire parameters
7	Increase	
4	Mode	On the interface of water heating, switch among Standard Water Heating, Preset Water Heating, and Nighttime Water Heating. (Note: On the interface of floor heating, mode can't be switched.)
5	Function	On the interface of water heating: switch among Sunflower, Water heating water temperature auto setting, Sterilizing, Rapid water heating; On the interface of floor heating: switch among Floor heating water temperature auto setting, Absence function, Rapid floor heating
2	Timer	Timer setting
8	On/Off	On/Off of water heating/ floor heating
6	Water heating/Air conditioning/Floor heating	Switch between water heating interface and floor heating interface (only when water heating and floor heating functions are valid).
7 and 3	Child lock	Press and hold these two buttons for 5 seconds to activate or cancel child lock function.

4.3 Installation and Debugging of Wired Controller

Unit: mm

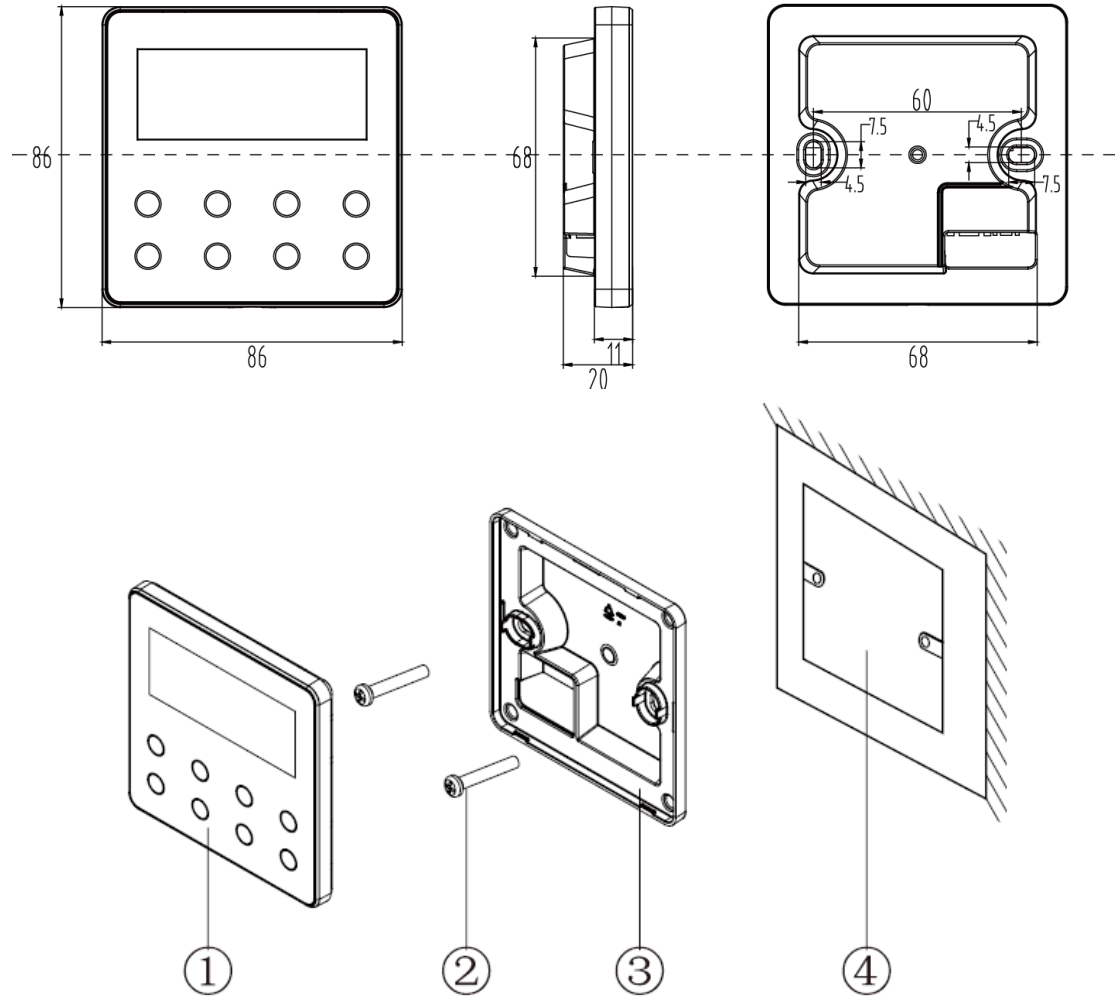

No.	1	2	3	4
Name	Panel of wired controller	Screw M4X25	Soleplate of wired controller	Wiring box mounted in the wall
Quantity	1 pc	2 pc	1 pc	Prepared by user

4.3.1 Installation of Wired Controller

4.3.1.1 Selection of Communication Wire

Wire material type	Total length of communication wire between hydro box and wired controller L(m)	Wire size (mm ²)	Material standard	Remarks
Light/Ordinary polyvinyl chloride sheathed cord (RVV)	L≤250	2×0.75~2×1.25	GB/T 5023.5-2008	Total length of communication wire can't exceed 250m.
Shielding light/Ordinary polyvinyl chloride sheathed	L≤250	2×0.75~2×1.25	GB/T 5023.5-2008	If unit is installed in a place with

GMV5 Home DC Inverter Multi VRF Units

twisted copper cord (RVVSP)			strong electromagnetic interference, use shielding wire (RVVSP).
--------------------------------	--	--	--

△ **Note:**

- ① If air conditioner is installed in a place with strong electromagnetic interference, communication wire of wired controller must be shielding twisted pair.
- ② Materials of communication wire for wired controller must be selected according to this manual strictly.

4.3.1.2 Installation Requirements

- (1) Never install the wired controller at wet places.
- (2) Never install the wired controller under direct sunlight.
- (3) Never install the wired controller at a place near high temperature objects or water-splashing places.

4.3.1.3 Wiring Requirements

There are four network wiring methods between wired controller and hydro box:

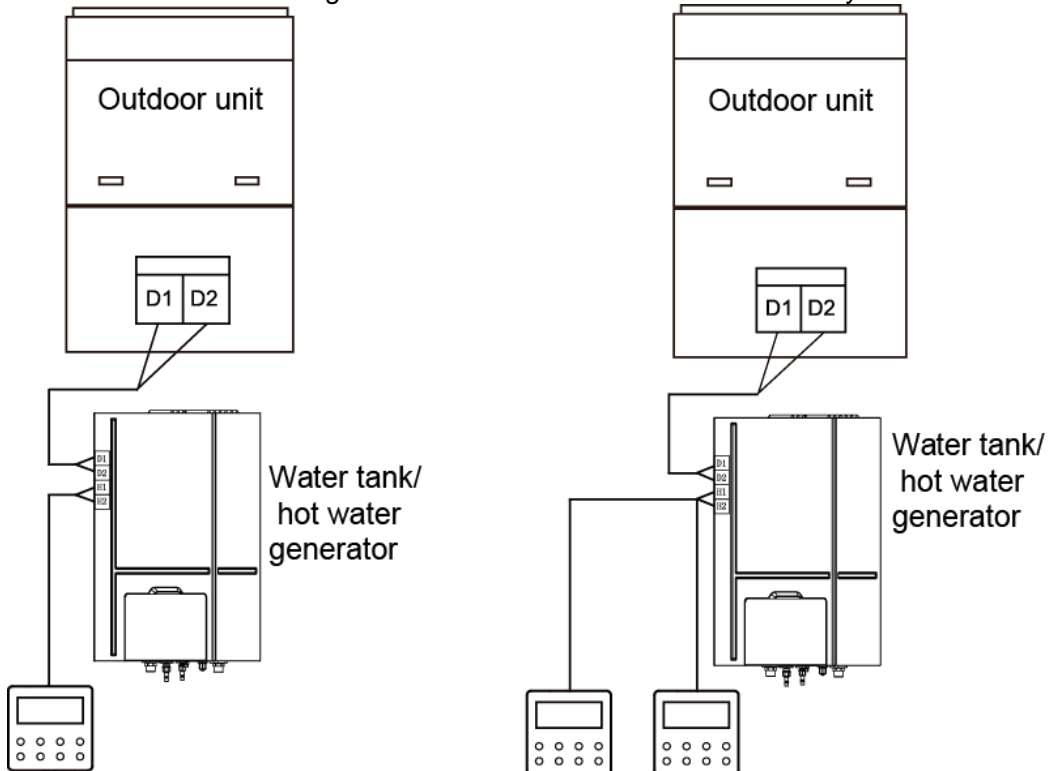

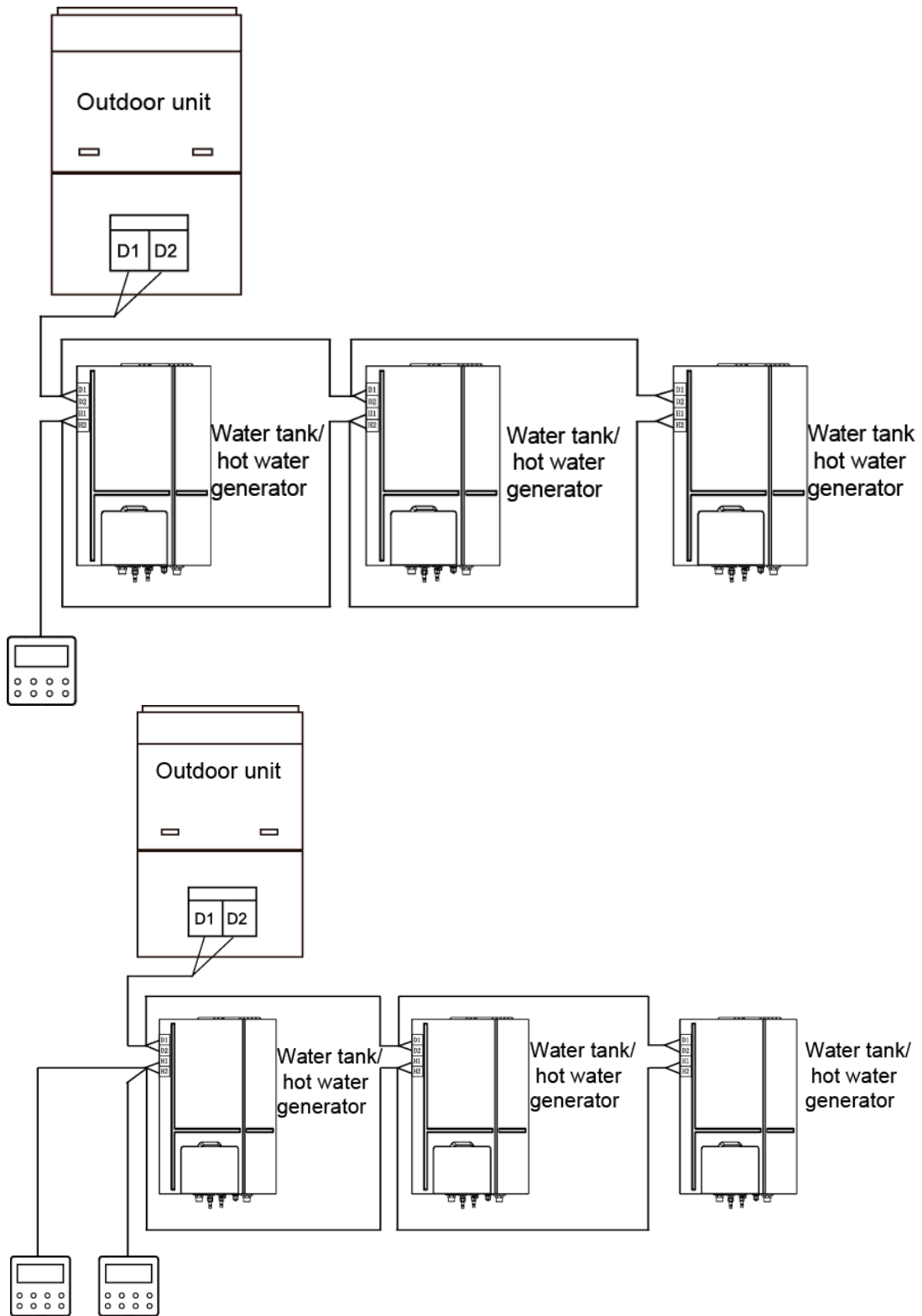

Wiring instructions:

- (1) When one wired controller controls multiple hydro boxes simultaneously, the wired controller can connect to any one hydro box, but all the connected units must be hydro boxes. The total quantity of hydro box controlled by wired controller can't exceed 3 sets, and the connected hydro box must be within the same network.
- (2) When two wired controllers control one hydro box, the addresses of those two wired controllers should be different. Please refer to section 4.3.2.2 for the setting method.
- (3) When two wired controllers control multiple hydro boxes, wired controller can connect to

any one hydro box, but all the connected units should be hydro boxes. The addresses of those two wired controllers should be different. Please refer to section 4.3.2.2 for the setting method. The total quantity of hydro box controlled by wired controller can't be more than 3 sets and all connected hydro boxes must be within the same network.

- (4) When one (or two) wired controller(s) control(s) multiple hydro boxes at the same time, the controlled hydro boxes' settings should be the same.
- (5) Network wiring between wired controller and hydro box must follow one of the four wiring methods as shown in Fig 3.4-3.7. As for the connection method shown in Fig 3.5 and 3.7, there should be only one master wired controller (address 01) and one slave wired controller (address 02). There can't be more than 2 wired controllers.

4.3.1.4 Installation

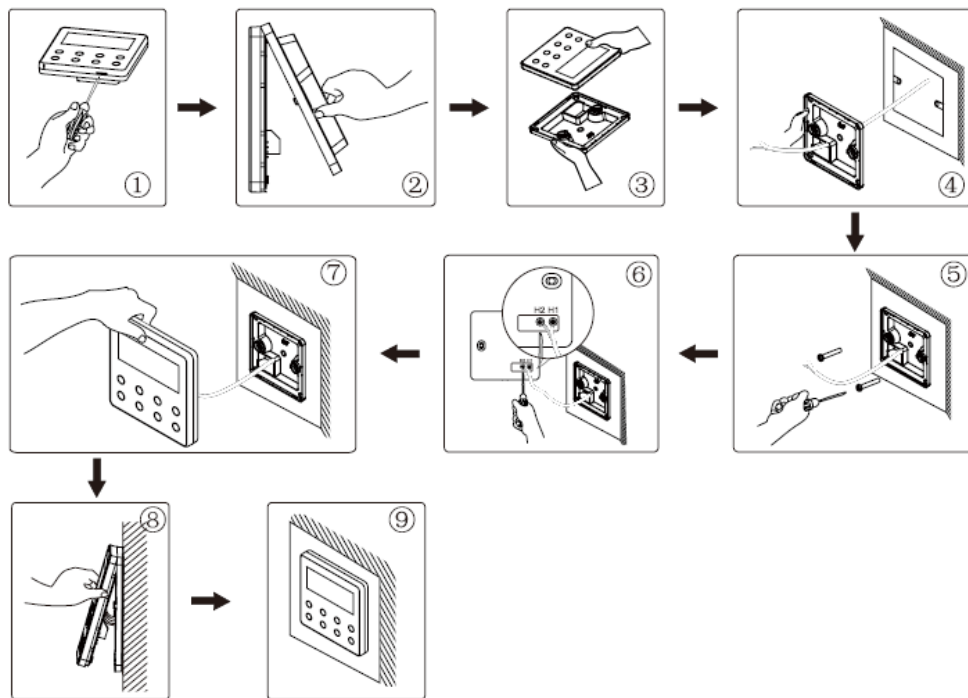
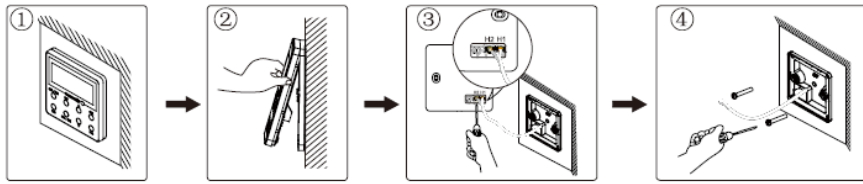

Figure above is a simple installation process of wired controller. Please pay attention to the following matters:

- (1) Before installation, please cut off the power for hydro boxes.
- (2) Pull out the 2-core twisted pair from the installation hole on wall, and then pull this wire through the wiring hole at the rear side of the soleplate of wired controller.
- (3) Stick the soleplate of wired controller on the wall and use screw M4x25 to fix the soleplate onto the installation hole on wall.
- (4) Connect the 2-core twisted pair to H1 and H2 wiring column and then tighten up the screws.
- (5) Bundle the panel and soleplate of wired controller together.

4.3.1.5 Disassembly



4.3.2 Debugging

4.3.2.1 Parameter Query

Unit's parameters can be queried under power-on or power-off status.

1. Press and hold "FUNCTION" button for 5 seconds to enter the interface of parameter query. "C00" is displayed in temperature zone and "Check" icon is on.

2. Press "▲" or "▼" button to select a parameter code.

3. Press "ENTER/CANCEL" button to return to the previous step until exiting the interface of parameter query.

4. Parameter query list is as below:

Parameter code	Parameter name	Parameter range	Query method
C00	Parameter setting ingress	-	In "C00" status, time zone displays the project number of the current hydro box. If one wired controller controls multiple hydro boxes, then only the smallest project number will be shown.
C01	Project number query of hydro box and location of a faulty hydro box	1-255: Project number of online hydro box	<p>Operation method: Enter query: Press "MODE" button in "C01" status to enter the interface of hydro box project number query. Press "▲" or "▼" button to switch the project number of hydro box.</p> <p>Display mode: Temperature zone displays the error of the current hydro box (Only the error of hydro box will be shown. If there are several errors, they are circularly displayed every 3 seconds). Timer zone displays (project number conflict C5 error)/ project number of the current hydro box.</p> <p>Note: "C01" query will not quit automatically upon time out. User has to exit "C01" manually.</p>
C03	Indoor air conditioner and hydro box quantity query in the system network	1-80	Timer zone displays the total number of indoor units (indoor air conditioner, hydro box) in the system.
C06	Preferential operation query	00: Common operation 01: Preferential operation	<p>Operation mode: In "C06" status, press "MODE" button to enter the interface of preferential operation query. Press "▲" or "▼" button to select a hydro box.</p> <p>Display mode: Temperature zone displays the project number of current hydro box. Timer zone displays the preferential operation setting value of</p>

GMV5 Home DC Inverter Multi VRF Units

			current hydro box.
C09	Wired controller address query	01, 02	Timer zone displays the address of current wired controller.
C11	Hydro box quantity query in the case that one wired controller controls many hydro boxes	1-3	Timer zone displays the total number of hydro boxes controlled by the wired controller.
C12	Outdoor ambient temperature query	-	Timer zone displays outdoor ambient temperature.
C18	One-key query for hydro box project number	1~255: Project number of online hydro box	<p>Operation method:</p> <p>Enter query: Press "MODE" button in "C18" status to turn on one-key query for hydro box project number. Wired controller will enter the interface of hydro box project number query. Press "▲" or "▼" button to switch the number of hydro box.</p> <p>Display mode:</p> <p>Temperature zone displays the number of the current hydro box. Timer zone displays the project number of the current hydro box.</p> <p>Note:</p> <ol style="list-style-type: none"> After turning on the one-key query for hydro box project number, all wired controllers in the system network will display the project number of hydro box that it controls in its timer zone (If one wired controller controls multiple hydro boxes, project numbers are displayed circularly every 3 seconds). Slave wired controller cannot turn on or cancel one-key query for hydro box project number. <p>Cancellation:</p> <ol style="list-style-type: none"> If user quits the "C18" query interface manually, the one-key query for hydro box project number is canceled immediately. If the "C18" query interface exits after 20 seconds upon time out, press "ON/OFF" button in power-on or power-off status to cancel the one-key query for hydro box project number. After turning on the one-key query for hydro box project number, press "ON/OFF" button on any wired controller in the same network under power-on or power-off status to quit the one-key query for hydro box project number.
C21	Water	0~100℃	Operation method:

GMV5 Home DC Inverter Multi VRF Units

	temperature query for water heating		<p>Press "MODE" button in "C21" status to enter the interface of water tank water temperature query. Press "▲" or "▼" button to switch the number of hydro box.</p> <p style="text-align: center;">Display mode:</p> <p>Temperature zone displays the project number of the current hydro box.</p> <p>Timer zone displays the water temperature of the current hydro box.</p>
--	-------------------------------------	--	---

Note:

In parameter query status, "FUNCTION", "TIMER" and "WATER/AC/FLOOR" buttons are invalid. By pressing "ON/OFF" button, user can return to the main interface but not power on or off the unit.

4.3.2.2 Parameter Settings

Parameters can be set in power-on or power-off status.

1. Press and hold "FUNCTION" button for 5 seconds, the temperature zone will display "C00". Then press and hold the "FUNCTION" button for another 5 seconds to enter the interface of wired controller parameter setting. Temperature zone will display "P00".

2. Select a parameter code by pressing "▲" or "▼". Press "MODE" button to switch to parameter value settings. The parameter value blinks. Adjust the parameter value by pressing "▲" or "▼". Then press "ENTER/CANCEL" button to complete the setting.

3. Press "ENTER/CANCEL" button to return to the previous step until exiting parameter settings.

Parameter setting list is as below:

Parameter code	Parameter name	Parameter range	Default value	Remarks
P13	Wired controller address setting	01: Master wired controller 02: Slave wired controller	01	When two wired controllers simultaneously control one or more hydro boxes, the two wired controller should use different addresses. The slave wired controller (address: 02) doesn't have the function of parameter setting except the function of setting its own address.
P14	Quantity setting of group-controlled hydro boxes	00: Disabled 01-03: Number of hydro boxes	01	This value is set based on the number of connected hydro boxes.
P43	Setting of preferential operation	00: Common operation 01: Preferential operation	00	When power supply is insufficient, hydro box that is set with preferential operation can be turned on or off at will while other hydro boxes will be powered off forcibly.
P46	Water temperature keeping function for water tank standby status	00: Allowed 01: Not allowed	00	
P47	Temperature	35~46℃	42℃	

GMV5 Home DC Inverter Multi VRF Units

	setting value of water temperature keeping function for water tank standby status			
P50	Water temperature setting of sunflower water temperature keeping function	35~50℃	40℃	
P53	Corrected value of water heating water temperature auto setting	-2~8℃	0℃	
P54	Cycling days of high-temperature sterilizing	0~60	0	If it is set to 0, high-temperature sterilizing function is valid only once.
P55	Advanced startup time of high-temperature sterilization	0~3 hours	1	
P56	On/Off of electric heating under normal water heating	00: ON 01: OFF	00	
P58	On/Off of auto heat recovery	00: ON 01: OFF	00	
P59	Water temperature setting of auto heat recovery	35~46℃	42℃	
P73	On/Off of rapid heating	00: ON 01: OFF	01	
P80	On/Off of electric heating for floor heating	00: ON 01: OFF	00	

Note:

In parameter setting status, "WATER/AC/FLOOR" and "TIMER" buttons are invalid. By pressing "ON/OFF" button, user can return to the main interface but not power on or off the unit.

4.4 Operation Instructions

4.4.1 Switch between Water Heating Interface and Floor Heating Interface

Under any status with no other operation (If there is other operation, please exit first), press

“WATER/AC/FLOOR” button to switch between water heating interface and floor heating interface.

On the interface of floor heating, user can switch to the interface of water heating by pressing “WATER/AC/FLOOR” button.

On the interface of water heating, user can switch to the interface of floor heating by pressing “WATER/AC/FLOOR” button.

If wired controller displays water heating interface,  icon is on.

If wired controller displays floor heating interface,  icon is on.

Note:

1. If the project has water heating function only, wired controller only displays water heating interface. It can't switch to floor heating interface.
2. If the project has floor heating function only, wired controller only displays floor heating interface. It can't switch to water heating interface.
3. Only when hydro box is connected and water heating and floor heating functions are both effective, will the wired controller switch interfaces and display as instructed above.

4.4.1 On/Off of Water Heating

On/Off of water heating: Press “ON/OFF” button, and water heating will be on or off.

On the interface of floor heating: press “WATER/AC/FLOOR” button once to activate the interface of water heating. Then switch according to the following instructions:

If water heating is on: press “ON/OFF” button to turn it off.

If water heating is off: press “ON/OFF” button to turn it on.

On the interface of water heating: switch on or off according to the above instructions.

Wired controller displays as below when water heating is on or off:

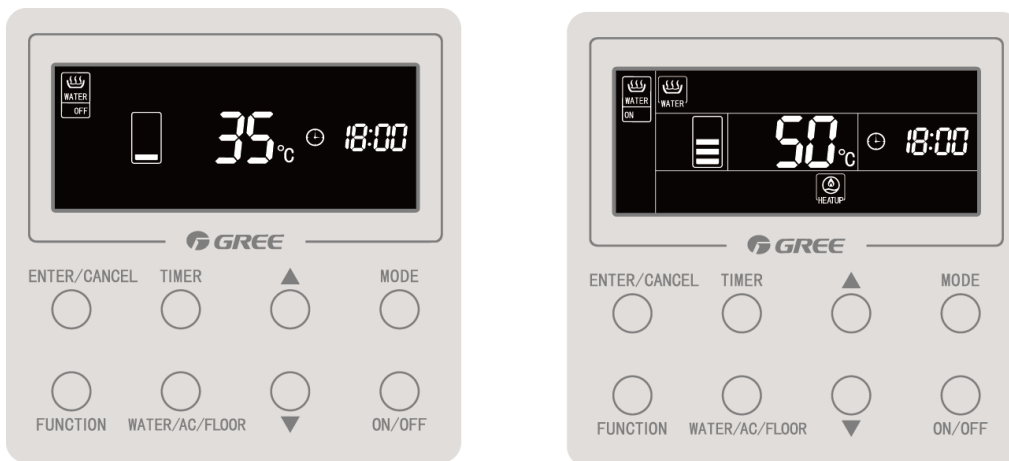

4.4.3 Mode Setting of Water Heating

When water heating is on, pressing “MODE” button will switch working mode circularly as below:

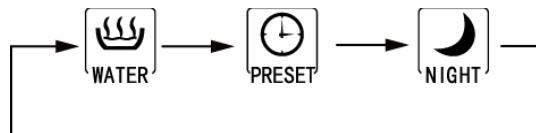

Water heating mode: Hydro box starts water heating according to the currently set water temperature or stops water heating.

Preset mode: Water heating can be preset. Hydro box will start up in advance according to actual water temperature and turn compressor on or off according to the difference between actual water temperature and set water temperature. Hydro box will stop working 1~4 hours after the preset time. If preset mode is activated, it will work repeatedly every day.

Night mode: Water heating time will be fixed at the period from 00:00 to 06:00. During this period, hydro box will work and turn compressor on or off according to the difference between actual water temperature and set water temperature. Out of this period, hydro box will not work. If night mode is activated, it will work repeatedly every day.

4.4.4 Water Temperature Setting of Water Heating

When water heating is on, pressing “▲” or “▼” button will increase or decrease set

temperature by 1°C. Holding “▲” or “▼” button will increase or decrease set temperature by 1°C every 0.3 seconds.

Under Standard Water Heating, Preset Water Heating and Nighttime Water Heating, temperature setting range is 35°C~maximum water temperature for water heating. Default water temperature is 50°C.

Note:

1. Default maximum water temperature is 55°C. Professional operators can adjust the maximum water temperature from 55°C to 70°C.
2. Water temperature setting ranges for Standard Water Heating, Preset Water Heating and Nighttime Water Heating are the same. Temperature setting value under each mode is independent of one other.
3. When water heating water temperature auto setting function is effective, pressing “▲” or “▼” button will not change the water temperature.

4.4.5 Switch of Water Heating Functions

The following functions can be set when water heating is on or off:

Water heating is on/off	Functions	Remarks
Water heating is in standard mode	Sunflower, Water Heating Water Temperature Auto Setting, High-temperature Sterilizing, Rapid Water Heating	
Water heating is in preset mode	Water Heating Water Temperature Auto Setting, High-temperature Sterilizing, Rapid Water Heating	
Water heating is in night mode	Water Heating Water Temperature Auto Setting, High-temperature Sterilizing, Rapid Water Heating	
Water heating is off	High-temperature Sterilizing	

When water heating is turned on in standard mode, pressing “FUNCTION” button once will change water heating functions circularly as below:

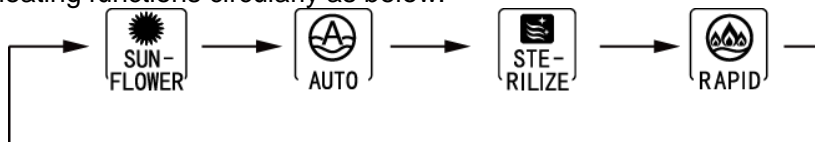

When water heating is turned on in preset mode or night mode, pressing “FUNCTION” button will change water heating functions circularly as below:



When water heating is turned off, only the sterilizing function will be available. Press “FUNCTION” button, and the icon “Sterilize” will blink.

Note:

1. If a function is shielded or disabled because of some reason, wired controller will skip this function when “FUNCTION” button is pressed.
2. For Rapid function, Auto function and Sunflower function, if they can't be set in a certain water heating mode, their icons will not display. If they can be set in a certain water heating mode, user can set or cancel these functions in that mode.

4.4.6 Setting of Sunflower Function

Sunflower: System will locate the highest outdoor temperature of the previous day according to the records of outdoor temperature. Then it will decide the water heating time to save energy.

Setting of sunflower function: Under standard water heating mode, press “FUNCTION” button to switch to sunflower function. Icon of sunflower blinks. Press “ENTER/CANCEL” to enable sunflower function.

Cancellation of sunflower function: Under standard water heating mode, press "FUNCTION"

button to switch to sunflower function. Then press "ENTER/CANCEL" to cancel sunflower function.

4.4.7 Setting of Water Heating Water Temperature Auto Setting

Water heating water temperature auto setting: Water heating water temperature will be set automatically by main board according to outdoor ambient temperature.

Setting of water heating water temperature auto setting: Under water heating, press "FUNCTION" button to switch to auto function. Icon of auto blinks. Press "ENTER/CANCEL" to enable the auto setting function.

Cancellation of water heating water temperature auto setting: Under water heating, press "FUNCTION" button to switch to auto function. Then press "ENTER/CANCEL" to cancel the auto setting function.

4.4.8 Setting of High-temperature Sterilizing

High-temperature sterilizing: Water in the water tank will be heated to 65~70°C (adjustable) in a set time to realize high-temperature sterilization.

1. If cycling days of high-temperature sterilizing is set to 0, it means sterilizing function is valid only once:

Setting of high-temperature sterilizing: On the interface of water heating, press "FUNCTION" button to switch to sterilizing. Icon of sterilizing blinks. Press "▲" or "▼" to adjust the temperature for sterilizing. Press "ENTER/CANCEL" button to enable the setting.

Cancellation of high-temperature sterilizing: On the interface of water heating, press "FUNCTION" button to switch to sterilizing. Press "ENTER/CANCEL" button to cancel the setting.

Setting of high-temperature sterilizing is as below:

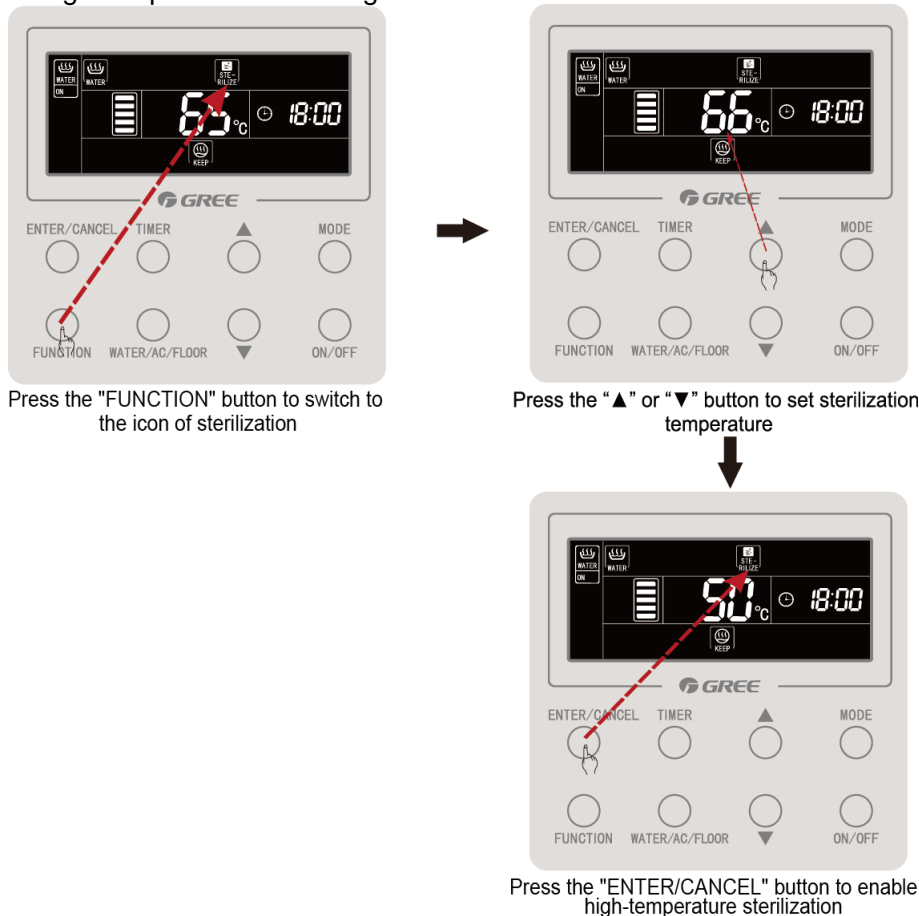

2. If cycling days of high-temperature sterilizing is set to be more than 0, it means sterilizing function is valid in a cycling way:

Setting of high-temperature sterilizing: On the interface of water heating, press "FUNCTION" button to switch to sterilizing. Icon of sterilizing blinks. Press "▲" or "▼" to adjust the temperature for sterilizing. Press "TIMER" button and the timer zone blinks. Press "▲" or "▼" to adjust the preset time for sterilizing. Press "ENTER/CANCEL" button to enable the setting.

Cancellation of high-temperature sterilizing: On the interface of water heating, press "FUNCTION" button to switch to sterilizing. Press "ENTER/CANCEL" button to cancel the setting.

Note:

- ① Preset time for sterilizing defaults to null and timer zone displays "--: --".
- ② Cycling days for sterilizing can be adjusted by professional operators. Default cycling days is 0.

Setting of high-temperature sterilizing is as below:

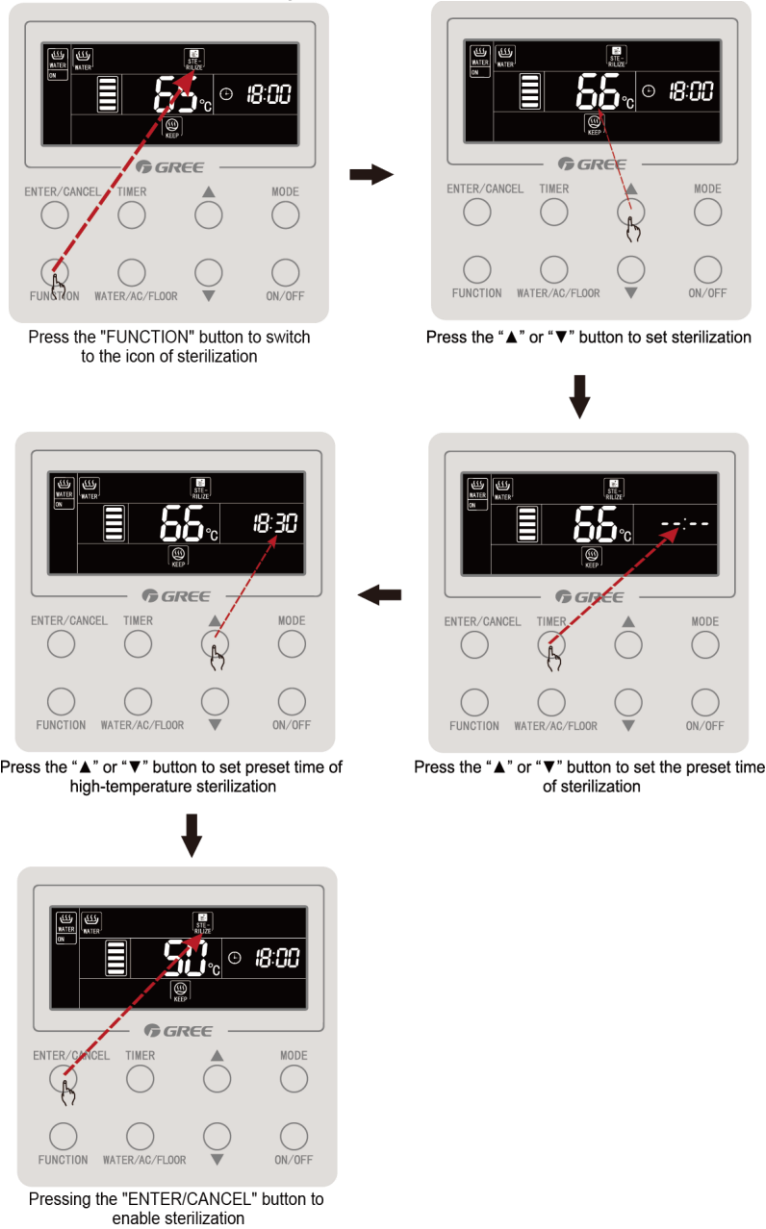

Cancellation of high-temperature sterilizing is as below:

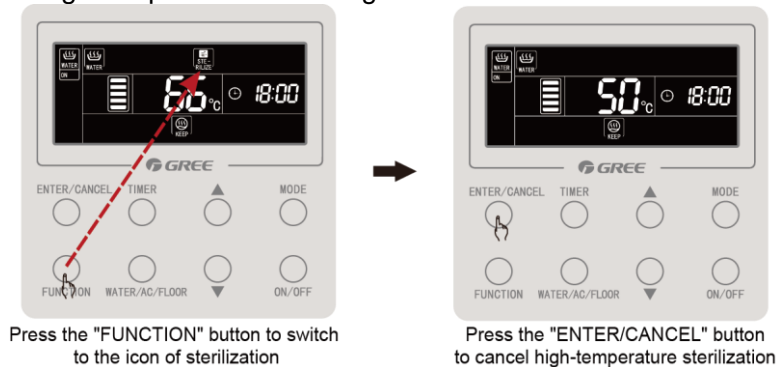

4.4.9 Setting of Rapid Water Heating

Rapid water heating: Under the condition allowed by outdoor unit, start compressor and electric heating to heat up water rapidly.

Setting of rapid water heating: Under water heating mode, press "FUNCTION" button to switch to rapid function. Icon of rapid function blinks. Press "ENTER/CANCEL" to enable the rapid function.

Cancellation of rapid water heating: Under water heating mode, press "FUNCTION" button to switch to rapid function. Press "ENTER/CANCEL" to cancel the rapid function.

Note:

① Rapid function is valid only once. When the hydro box reaches the condition of keeping temperature, rapid function is cancelled to save energy.

② After water heating is off, rapid water heating function is canceled.

4.4.10 Setting of Water Heating Timer On/Off

Whether water heating is on or off, water heating timer on or off can be set.

Setting of water heating timer:

Press "TIMER" to enter the setting of timer. Icon "ON" will blink.

Press "▲" or "▼" to adjust the timing for water heating to be turned on. Press "ENTER/CANCEL" to complete the setting.

Pressing "TIMER" button before pressing "ENTER/CANCEL" button can save the setting of timer on and switch to the setting of timer off. Icon "OFF" will blink.

Press "▲" or "▼" to adjust the timing for water heating to be turned off. Press "ENTER/CANCEL" button or "TIMER" button to complete the setting.

Pressing "▲" or "▼" each time will increase or decrease the time by 1 minute. However, holding "▲" or "▼" for 5 seconds will increase or decrease the time by 10 minutes.

Cancellation of water heating timer:

Press "TIMER" to enter the setting of timer. Pressing "TIMER" button can switch between timer on and timer off. Press "ENTER/CANCEL" to cancel water heating timer.

Setting of water heating timer is as below:



Power on with timer unset

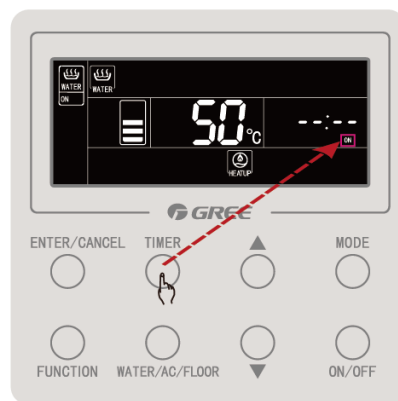

Press the "TIMER" button to set power-on timer for water heating



Press the "▲" or "▼" button to set the water heating

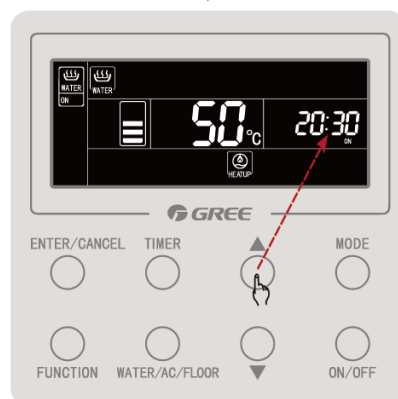

Press the "TIMER" button to switch to power-off timer for water heating



Press the "▲" or "▼" button to set the water heating power-off time



Press the "ENTER/CANCEL" button to enable the timer on/off for water heating

Cancellation of water heating timer on is as below:



Effective status of water heating timer



Press the "TIMER" button to switch to power-on timer



Press the "ENTER/CANCEL" button to cancel power-on timer for water heating

Cancellation of water heating timer off is as below:



Effective status of water heating timer



Press the "TIMER" button for twice to switch to power-off timer



Press the "ENTER/CANCEL" button to cancel water heating power-off timer

4.4.11. Setting of Preset Water Heating

Setting of preset water heating:

Under water heating mode, press "MODE" button to switch to preset mode (Then wired controller will remind user to set the preset time. If unit is already in preset mode, skip this step). Press "TIMER" button and the character "Preset" blinks.

Press "▲" or "▼" to adjust the preset time for water heating. Press "ENTER/CANCEL" button to complete the setting.

Cancellation of preset water heating:

Under water heating mode, press "MODE" button to switch to preset mode (If unit is already in preset mode, skip this step). Press "TIMER" button and the character "Preset" blinks. Press "ENTER/CANCEL" button to cancel the setting.

Setting of preset water heating is as below:

GMV5 Home DC Inverter Multi VRF Units



Power on status



Press the "MODE" button to switch preset mode



Press the "▲" or "▼" button to set the preset time for water heating

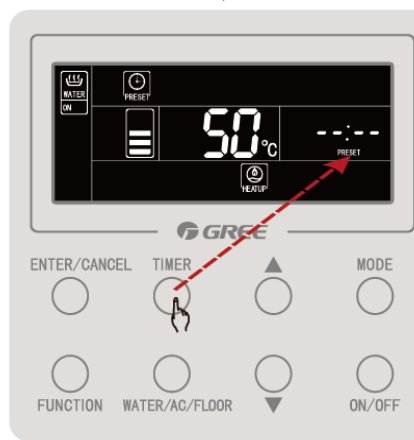

Press the "TIMER" button to enter the setting of water heating preset tin



Press the "ENTER/CANCEL" button to set the preset setting of water heating



Power on status

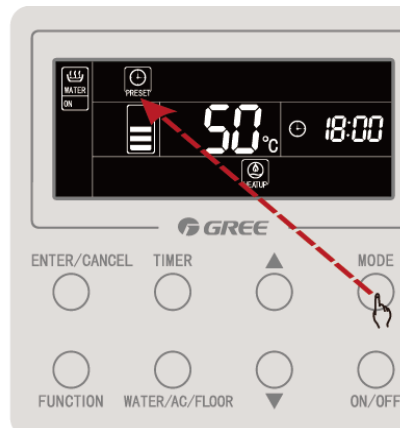

Press the "MODE" button to switch preset mode

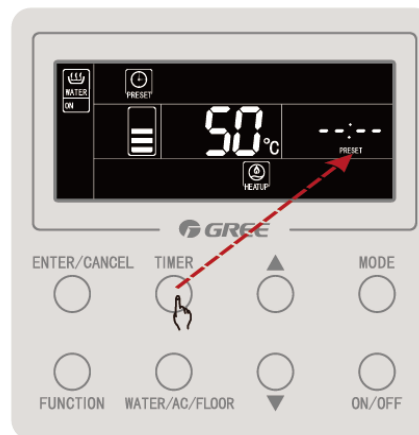

Press the "TIMER" button to enter the setting of water heating preset tin



Press the "▲" or "▼" button to set the preset time for water heating



Press the "ENTER/CANCEL" button to set the preset setting of water heating

Cancellation of preset water heating is as below:

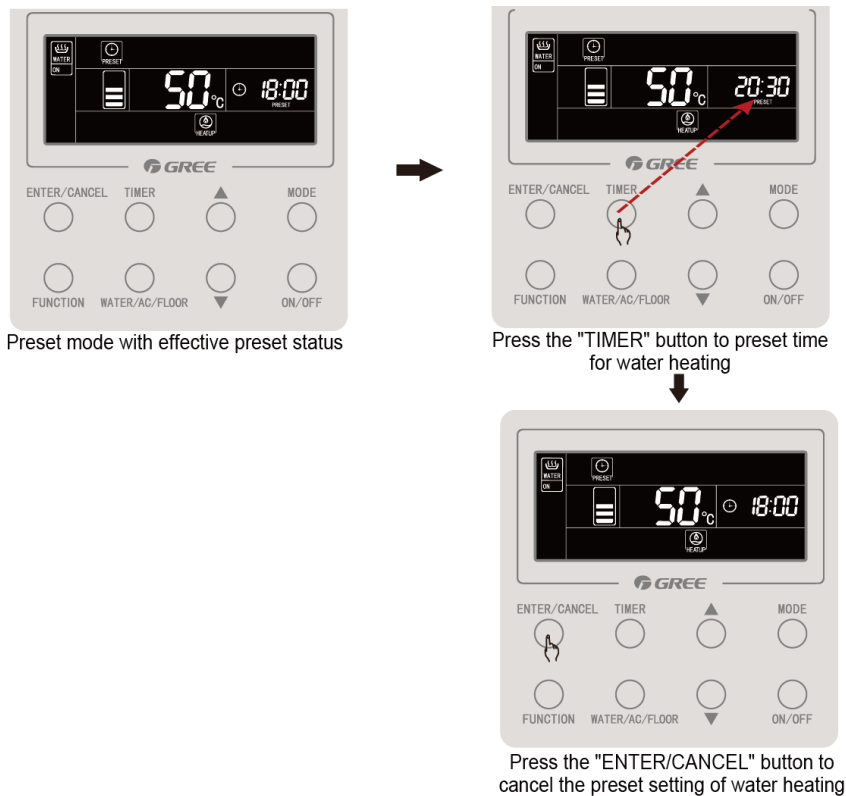

4.4.12. On/Off of Floor Heating

On/Off of floor heating: On the interface of floor heating, press "ON/OFF" button, and floor heating will be on or off.

On the interface of water heating: press "WATER/AC/FLOOR" button once to activate the interface of floor heating. After that, pressing "ON/OFF" each time will switch floor heating on or off.

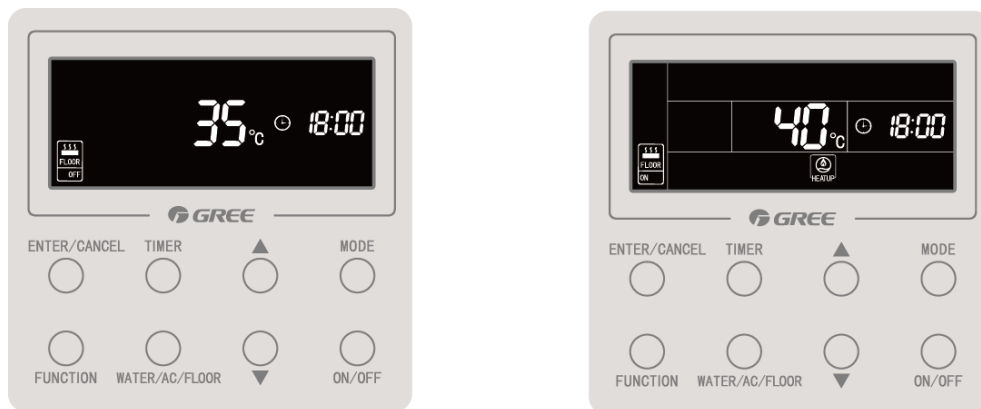

4.4.13. Water Temperature Setting of Floor Heating

When floor heating is on, pressing "▲" or "▼" button will increase or decrease set temperature by 1°C. Holding "▲" or "▼" button will increase or decrease set temperature by 1°C every 0.3 seconds.

Temperature setting range for floor heating is 25°C~maximum water temperature for floor heating. Default water temperature is 40°C.

Note:

1. Default maximum water temperature for floor heating is 45°C. Professional operators can adjust the maximum water temperature from 40°C to 52°C.

2. When floor heating water temperature auto setting function is effective, pressing "▲" or "▼" button will not change the water temperature.

4.4.14. Switch of Floor Heating Functions

The following functions can be set when floor heating is on or off:

Floor heating is on/off	Functions	Remarks
Floor heating is on	Floor Heating Water Temperature Auto Setting, Rapid Floor Heating, Absence	
Floor heating is off	Absence	

On the interface of floor heating, when floor heating is turned on, pressing “FUNCTION” button once will change floor heating functions circularly as below:



When floor heating is turned off, only the absence function will be available.

4.4.15. Setting of Floor Heating Water Temperature Auto Setting

Floor heating water temperature auto setting: Floor heating water temperature will be set automatically by hydro box main board according to outdoor ambient temperature.

Setting of floor heating water temperature auto setting: Under floor heating, press "FUNCTION" button to switch to auto function. Icon of auto blinks. In the temperature zone, current auto setting level will be blinking. Press “▲” or “▼” to select a setting level. Press “ENTER/CANCEL” to enable the auto setting function.

Cancellation of floor heating water temperature auto setting: Under floor heating, press “FUNCTION” button to switch to auto function. Then press “ENTER/CANCEL” to cancel the auto setting function.

4.4.16. Setting of Rapid Floor Heating

Rapid floor heating: Under the condition allowed by outdoor unit, start compressor and electric heating to heat the floor rapidly.

Setting of rapid floor heating: Under floor heating mode, press “FUNCTION” button to switch to rapid function. Icon of rapid function blinks. Press “ENTER/CANCEL” to enable the rapid function.

Cancellation of rapid floor heating: Under floor heating mode, press “FUNCTION” button to switch to rapid function. Press “ENTER/CANCEL” to cancel the rapid function.

Note:

① Rapid function is valid only once. When the hydro box reaches the condition of keeping temperature, rapid function is cancelled to save energy.

② After floor heating is off, rapid floor heating function is cancelled.

4.4.17. Setting of Floor Heating Absence Function

Floor heating absence function: When user is absent, unit will maintain the water temperature to avoid pipeline from frost and prevent indoor equipment from damage.

Setting of floor heating absence function: Under On/Off status of floor heating, press “FUNCTION” button to switch to absence function. Icon of absence blinks. Press “ENTER/CANCEL” to enable the absence function.

Cancellation of floor heating absence function: Under On/Off status of floor heating, press “FUNCTION” button to switch to absence function. Then press “ENTER/CANCEL” to cancel the absence function.

4.4.18. Setting of Floor Heating Timer On/Off

Whether floor heating is on or off, floor heating timer on or off can be set.

Setting of floor heating timer:

Press “TIMER” to enter the setting of timer. Icon “ON” will blink.

Press “▲” or “▼” to adjust the timing for floor heating to be turned on. Press “ENTER/CANCEL” to complete the setting.

Pressing “TIMER” button before pressing “ENTER/CANCEL” button can save the setting of timer on and switch to the setting of timer off. Icon “OFF” will blink.

Press “▲” or “▼” to adjust the timing for floor heating to be turned off. Press “ENTER/CANCEL” button or “TIMER” button to complete the setting.

Pressing “▲” or “▼” each time will increase or decrease the time by 1 minute. However, holding “▲” or “▼” for 5 seconds will increase or decrease the time by 10 minutes.

Cancellation of floor heating timer:
 Press "TIMER" to enter the setting of timer. Pressing "TIMER" button can switch between timer on and timer off. Press "ENTER/CANCEL" to cancel floor heating timer.
 Setting of floor heating timer is as below:

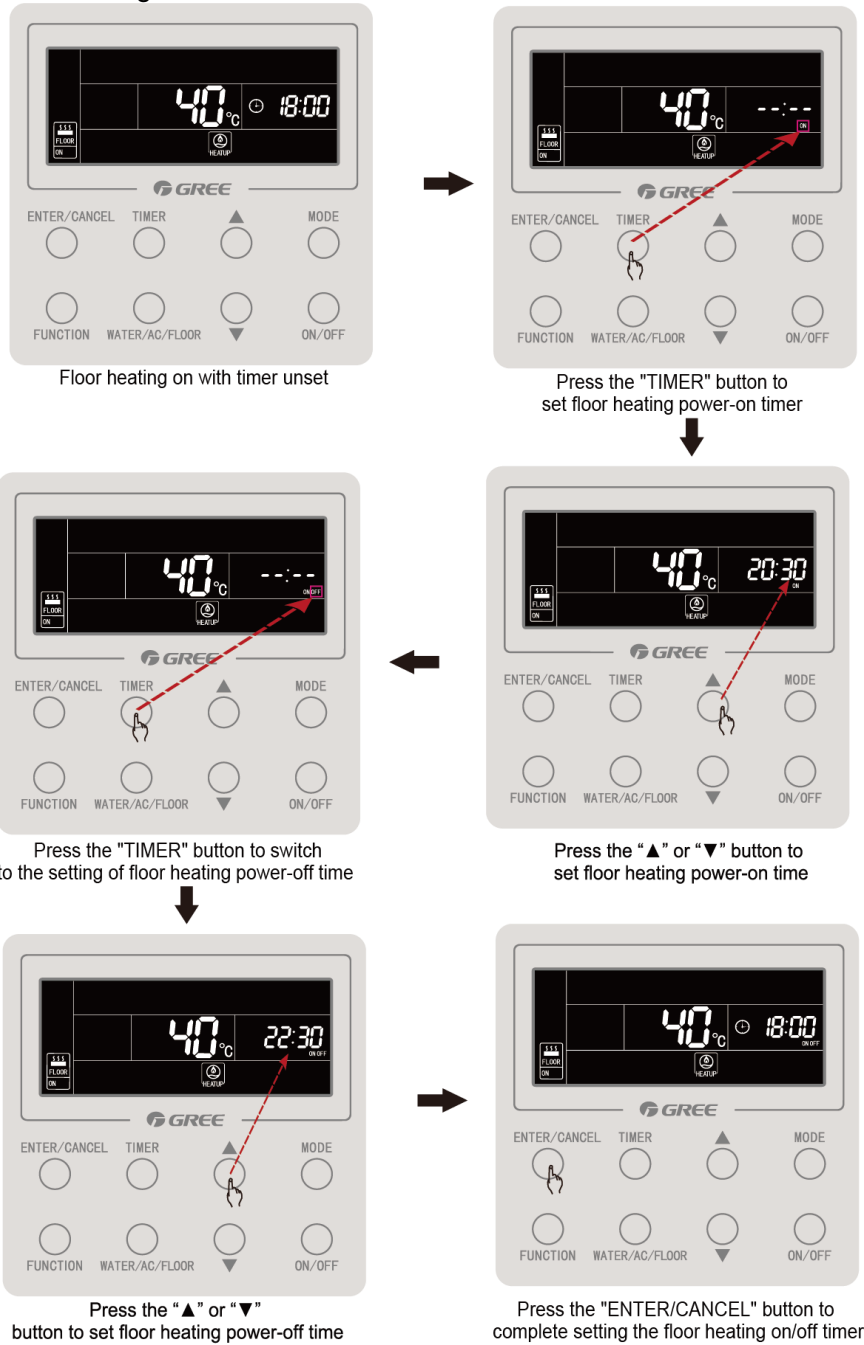

Cancellation of floor heating timer on is as below:



Effective status of floor heating power on/off timer



Press the "TIMER" button to switch to power-on timer



Press the "ENTER/CANCEL" button to cancel power-on timer of floor heating

Cancellation of floor heating timer off is as below:



Effective status of water heating timer

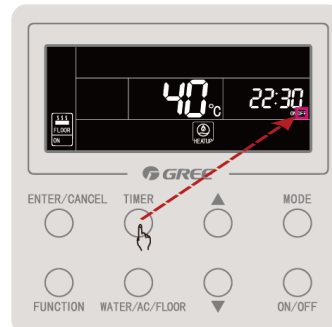

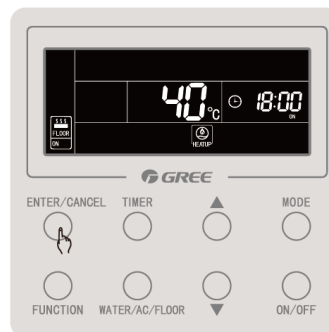

Press the "TIMER" button for twice to switch to power-off timer



Press the "ENTER/CANCEL" button to cancel water heating power-off timer

4.4.19 Setting of Clock

Clock display: Timer zone will display system clock whether unit is turned on or not. When icon  blinks, user can set the clock.

System clock: Hold "TIMER" button for 5 seconds to enter the setting of clock. Icon  blinks. Pressing "▲" or "▼" can increase or decrease the time by 1 minute. However, holding "▲"

or “▼” for 5 seconds can increase or decrease the time by 10 minutes. Then press “ENTER/CANCEL” button or “TIMER” button to save and exit the setting.

Setting of clock is as below:

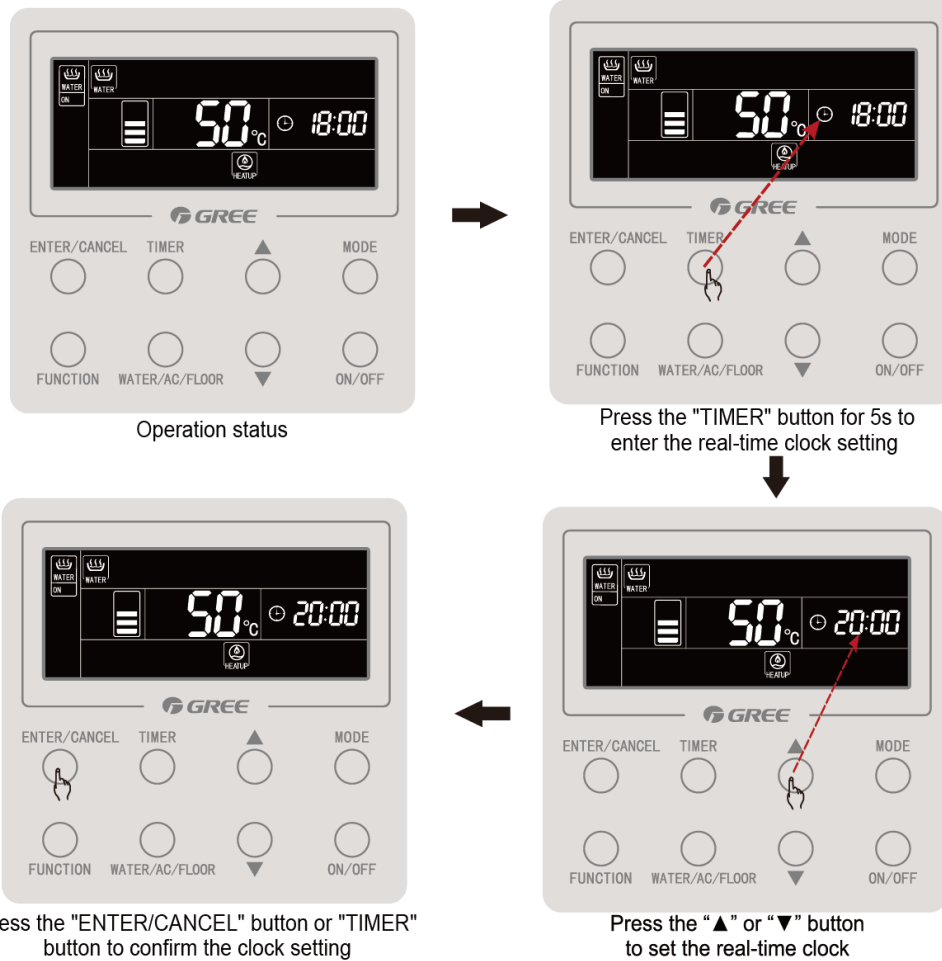

4.4.20 Setting of Cleaning



Start the water pump to drain and clean the waterway for the engineering installation.

When water heating and floor heating are off and sterilizing function is not taking place, press and hold “WATER/AC/FLOOR” button for 5 seconds. The character “CLEAN” is lit up. During cleaning, the character “CLEAN” will be blinking. Press and hold “WATER/AC/FLOOR” button for another 5 seconds, and cleaning will stop. The character “CLEAN” will be off.

4.4.21 Remote Shield

Remote shield: Remote monitor and central controller can disable relevant functions of wired controller so as to realize the function of remote control.

The function of remote shield includes all shield and partial shield. When All Shield function is on, all controls of the wired controller are disabled. When Partial Shield function is on, those controls that are shielded will be disabled.

When the remote monitor or central controller activates Remote Shield on the wired controller, icon of  will show. If user wants to control through the wired controller, icon  will blink to remind that these controls are disabled.

4.4.22 Child Lock

When unit is turned on or off normally, pressing “▲” and “▼” buttons together for 5 seconds will turn on child lock function.  will show on the display. Press and hold “▲” and “▼” buttons again for 5 seconds to turn off child lock function.

All the other buttons will be disabled when Child Lock function is on.

4.5 Malfunction Display

When malfunction occurs during operation, temperature zone of wired controller will display malfunction codes. If several malfunctions happen at the same time, malfunction codes will be displayed one by one circularly.

Note: If malfunction occurs, please turn off the unit and send for professionals to repair. Below is a display when the quantity of group controlled hydro boxes is inconsistent.



4.5.1 Table of Malfunction Codes for Outdoor Unit

Content symbol Distinctive symbol		0	1	2	3	4	5
Indoor	L	Indoor unit malfunction	Indoor fan protection	Auxiliary heating protection	Water overflow protection	Power supply over-current protection	Anti-freezing protection
	d		Indoor unit PCB malfunction	Malfunction of water tank lower water temperature sensor	Malfunction of ambient temperature sensor	Malfunction of inlet tube temperature sensor	Malfunction of middle temperature sensor
	y						
Outdoor	E	Outdoor unit malfunction	High pressure protection	Low discharge temperature protection	Low pressure protection	Compressor high discharge temperature protection	
	F	Outdoor unit main board malfunction	Malfunction of high pressure sensor		Malfunction of low pressure sensor		Malfunction of discharge temperature sensor for compressor 1
	J	Other module protection	Over-current protection for compressor 1	Over-current protection for compressor 2	Over-current protection for compressor 3	Over-current protection for compressor 4	Over-current protection for compressor 5
	b		Malfunction of outdoor	Malfunction of defrosting	Malfunction of defrosting	Malfunction of	Malfunction of

GMV5 Home DC Inverter Multi VRF Units

			ambient temperature sensor	temperature sensor 1	temperature sensor 2	sub-cooler outflow temperature sensor	sub-cooler exhaust temperature sensor
	P	Compressor drive board malfunction	Compressor drive board operation error	Compressor drive board power voltage protection	Compressor drive module reset protection	Compressor drive PFC protection	Inverter compressor over-current protection
	H	Fan drive board malfunction	Fan drive board operation error	Fan drive board power voltage protection	Fan drive module reset protection	Fan drive PFC protection	Variable frequency fan over-current protection
Commissioning	U	Deficient preheating of compressor		Wrong outdoor unit capacity code/jumper cap setting	Power phase sequence protection	Refrigerant shortage protection	Wrong compressor drive board address
	C	Communication failure between indoor and outdoor units, and indoor unit wired controllers		Communication failure between main control board and inverter compressor drive	Communication failure between main control board and variable frequency fan drive	Malfunction of lack of indoor unit	Indoor unit project number conflict warning
Status	A	Unit is ready for commissioning.		After-sales refrigerant recycling	Defrosting	Oil return	
	n	Economic mode setting			Forcible defrosting	Maximum output capacity	Forcible offset of indoor unit project number

Content symbol Distinctive symbol		6	7	8	9	A	H
Indoor	L	Mode conflict	No master indoor unit	Power supply shortage	Inconsistent number of group-controlled indoor units	Inconsistent series of group-controlled indoor units	Warning against poor air quality
	d	Malfunction of outlet tube temperature sensor	Malfunction of humidity sensor	Malfunction of water temperature sensor	Jumper cap malfunction	Indoor unit network address error	Wired controller PCB error
	y						
Outdoor	E						
	F	Malfunction of discharge temperature sensor for compressor 2	Malfunction of discharge temperature sensor for compressor 3	Malfunction of discharge temperature sensor for compressor 4	Malfunction of discharge temperature sensor for compressor 5	Malfunction of discharge temperature sensor for compressor 6	Compressor 1 current sensor error
	J	Over-current protection for compressor 6	4-way valve leakage protection	High system pressure ratio protection	Low system pressure ratio protection	Exceptional pressure protection	
	b	Malfunction of gas separator inlet tube	Malfunction of gas separator outlet tube	Malfunction of outdoor humidity sensor	Malfunction of heat exchanger exhaust temperature	Malfunction of oil return 1 temperature sensor	System clock error

GMV5 Home DC Inverter Multi VRF Units

		temperature sensor 1	temperature sensor (outlet tube A)		sensor		
	P	Compressor drive IPM module protection	Compressor drive temperature sensor malfunction	Compressor drive IPM over-temperature protection	Inverter compressor out-of-step protection	Compressor drive storage chip malfunction	Compressor drive DC bus high voltage protection
	H	Fan drive IPM module protection	Fan drive temperature sensor malfunction	Fan drive IPM over-temperature protection	Variable frequency fan out-of-step protection	Variable frequency fan drive storage chip malfunction	Fan drive DC bus high voltage protection

Content symbol	Distinctive symbol	6	7	8	9	A	H
Commissioning	U	Warning against valve error		Indoor unit pipeline malfunction	Outdoor unit pipeline malfunction		
	C	Warning against inconsistency of outdoor unit number	Converter communication error	Compressor emergency status	Fan emergency status	Module emergency status	Rated capacity ratio of indoor and outdoor units is too high
Status	A	Setting of cooling and heating	Setting of quiet mode	Mode of vacuum pumping			Heating
	n	Unit malfunction query	Unit parameter query	Indoor unit project number query	Query of the number of online indoor units	Cooling and heating model	Heating model

Content symbol	Distinctive symbol	C	L	E	F	J	P
Indoor	L	Models of indoor and outdoor units are not matched	Malfunction of water flow switch	Abnormal rotation speed of EC DC water pump	Malfunction of shunt valve setting	Wrong setting of function DIP switch	PG motor zero-crossing malfunction
	d	Abnormal setting of capacity DIP switch	Malfunction of air discharge temperature sensor	Malfunction of indoor CO ₂ sensor	Malfunction of water tank upper water temperature sensor	Malfunction of backwater temperature sensor	Malfunction of floor heating water inlet pipe temperature sensor
	y						
Outdoor	E						
	F	Compressor 2 current sensor error	Compressor 3 current sensor error	Compressor 4 current sensor error	Compressor 5 current sensor error	Compressor 6 current sensor error	DC motor malfunction
	J	Water flow switch protection	Low high pressure protection	Oil return pipe is blocked	Oil return pipe is leaking		
	b	Compressor 1 top cover temperature sensor falling protection	Compressor 2 top cover temperature sensor falling protection	Malfunction of condenser inlet tube temperature sensor	Malfunction of condenser outlet tube temperature sensor	High pressure and low pressure sensors are connected	Malfunction of oil return 2 temperature sensor

GMV5 Home DC Inverter Multi VRF Units

						reversely.	
	P	Malfunction of compressor drive current detection circuit	Compressor drive DC bus low voltage protection	Inverter compressor out-of-phase protection	Malfunction of compressor drive recharging circuit	Inverter compressor startup failure	Inverter compressor AC current protection
	H	Malfunction of fan drive current detection circuit	Fan drive DC bus low voltage protection	Variable frequency fan out-of-phase protection	Malfunction of fan drive recharging circuit	Variable frequency startup failure	Variable frequency fan AC current protection
Commissioning	U	Master indoor unit is set.	Compressor emergency operation DIP switch is wrong	Ineffective refrigerant charging			
	C	Malfunction of lack of master unit	Rated capacity ratio of indoor and outdoor units is too low		Malfunction due to multiple master control units	DIP switch conflict of system address	Malfunction due to multiple master wired controllers
Status	A	Cooling	Auto refrigerant charging	Manual refrigerant charging	Fan blow	Filter cleaning reminder	Unit starting commissioning confirmation
	n	Cooling model		Negative code	Fan model	High temperature prevention in heating	

Content symbol Distinctive symbol	U	b	d	n	y
Indoor	L				
	D	Malfunction of floor heating water outlet tube temperature sensor	Project commissioning	Malfunction of solar power temperature sensor	Malfunction of air guide louver
	Y				
Outdoor	E				
	F	Malfunction of compressor 1 top cover temperature sensor	Malfunction of compressor 2 top cover temperature sensor		
	J				
	B	Malfunction of oil return 3 temperature sensor	Malfunction of oil return 4 temperature sensor		
	P	Inverter compressor drive AC input voltage abnormal protection			
	H	Inverter compressor drive AC input current abnormal protection			

GMV5 Home DC Inverter Multi VRF Units

Commissioning	U					
	C	Communication malfunction between indoor unit and the receiver board	Overflow distribution of IP address			
Status	A	Remote emergency shutdown	Emergency shutdown	Restricted operation	Child lock status	Shielding status
	N	Eliminate the long-distance shielding command of indoor unit	Barcode inquiry		Outdoor unit connection pipe length correction	

4.5.2 Table of Malfunction Codes for Hydro Box

Display code	Description	Display code	Description	Display code	Description
L0	Hydro box malfunction	LL	Malfunction of water flow switch	dA	Hydro box network address error
L4	Power supply over-current protection	LE	Abnormal rotation speed of EC DC water pump	dH	Wired controller PCB error
L5	Anti-freezing protection	LF	Malfunction of floor heating shunt valve setting	dF	Malfunction of upper water temperature sensor
L6	Mode conflict	d1	Indoor unit PCB malfunction	dJ	Malfunction of backwater temperature sensor
L8	Power supply shortage	d2	Malfunction of lower water temperature sensor	dP	Malfunction of hydro box water inlet temperature sensor
L9	Inconsistent number of group-controlled hydro boxes	d4	Malfunction of refrigerant inlet tube temperature sensor	dU	Malfunction of hydro box water outlet temperature sensor
LA	Inconsistent series of group-controlled hydro boxes	d6	Malfunction of refrigerant outlet tube temperature sensor	db	Special code: project commissioning code
LC	Models of hydro box and outdoor unit are not matched	d9	Jumper cap malfunction	dd	Malfunction of solar power temperature sensor

4.5.3 Table of Commissioning Codes

Display code	Description	Display code	Description	Display code	Description
U2	Wrong outdoor unit capacity code/ jumper cap setting	UE	Ineffective refrigerant charging	CH	Rated capacity ratio is too high.
U3	Power phase sequence protection	UL	Compressor emergency operation DIP switch is wrong.	CL	Rated capacity ratio is too low.
U4	Refrigerant shortage protection	C0	Communication failure between indoor and outdoor units, indoor units and wired controllers	CF	Malfunction due to multiple master control units
U5	Wrong compressor drive board address	C2	Communication failure between main control board and inverter compressor drive	CJ	DIP switch conflict of system address
U6	Warning against valve error	C3	Communication failure between main control board and variable	CP	Malfunction due to multiple master wired

GMV5 Home DC Inverter Multi VRF Units

			frequency fan drive		controllers
U8	Indoor unit pipeline malfunction	C4	Malfunction of lack of indoor unit	CU	Communication malfunction between indoor unit and the receiver board
U9	Outdoor unit pipeline malfunction	C5	Indoor unit project number conflict warning	Cb	Overflow distribution of IP address
UC	Master indoor unit is set.	C6	Warning against inconsistency of outdoor unit number		

4.5.4 Table of Status Codes

Display code	Description	Display code	Description
A0	Unit is ready for commissioning.	A8	Mode of vacuum pumping
A1	Compressor operating parameter query	AJ	Filter cleaning reminder
A2	After-sales refrigerant recycling	AU	Remote emergency shutdown
A3	Defrosting	Ab	Emergency shutdown
A5	Online test	Ad	Restricted operation

Chapter 3 Installation

1. Engineering Installation Flowchart

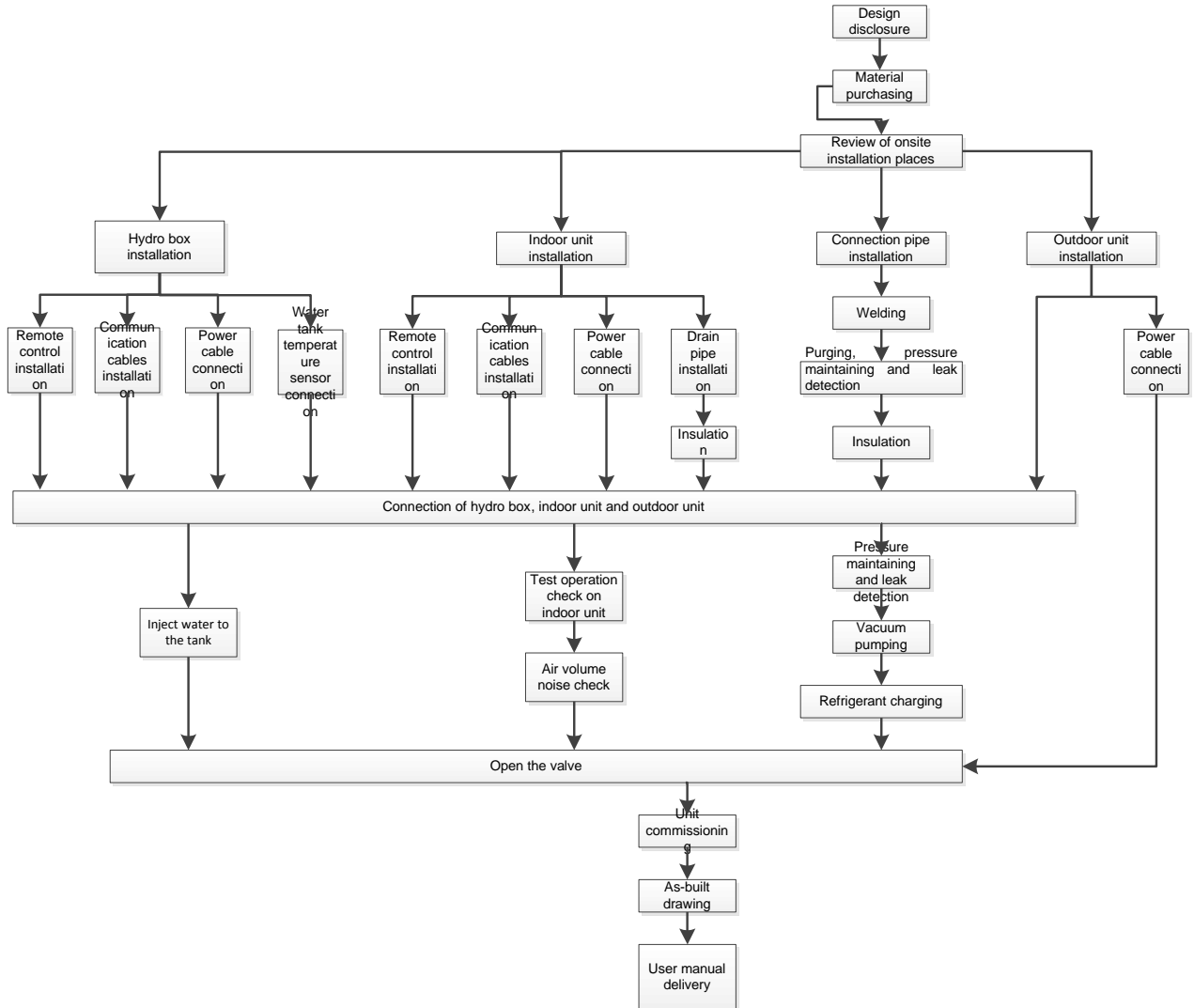

2.Common Tools and Devices

- Three-stage distribution box----Fig. 1
- Multifunctional measurement gauge---Fig. 2

The measurement gauge shall be able to withstand higher pressure. The size of connection pipe is different from the previous pipe in order to avoid misuse.

- Control valve---Fig. 3

Avoid overflow of refrigerant during moving and enable instant open and close of liquid pipe side and refrigerant charging tank port.

- Charging safety device (gas-liquid separator)

Usually, refrigerant must be changed into liquid state. Since R410A is a kind of mixed refrigerant, hazards may be caused if the mixed ratio changes. In order to avoid refrigerant flowing back to compressor in liquid state, this device can be used to make refrigerant get into compressor securely.

- Electronic scale----Fig. 5

Electronic scale is the recommended device for charging R410A.

- Refrigerant container---Fig. 6

Confirm the refrigerant type before charging. Usually, R410A refrigerant in liquid state shall be charged.

- Thermal resistor vacuum measurement meter---Fig. 7

In order to remove the vapor in refrigeration circulation, proper vacuum drying must be applied. For this purpose, you can use this device to check if the system is vacuum.

- Vacuum pump---Fig. 8

Use it to vacuum the refrigeration circulation and detection system.

- Welding tool---Fig. 9
- Pipe bender---Fig. 10
- Pipe expander---Fig. 11

In order to adapt to the high pressure of R410A, the shape of expander is different from the conventional one.

- Nitrogen tank---Fig. 12

The nitrogen in the tank is for driving oxygen during welding in order to avoid forming oxidation film and oxidation inside the system.

- Phillips screwdriver/Slotted Screwdriver---Fig. 13
- Clipper---Fig. 14
- Adjustable wrench 8 / 12---Fig. 15
- Momental wrench---Fig. 16

Tighten flaring nut

- Double-ended pressure meter---Fig. 17
- Level bar---Fig. 18
- Impact electric hammer---Fig. 19
- Electric hand drill--Fig. 20
- Oxygen relief valve/Nitrogen relief valve/Acetylene relief valve/ Backfire check valve--Fig. 21
- Gas leakage detector--Fig. 22

Specialized for leakage detection for HFC refrigerant.

- Refrigerant cleaner--Fig. 23
- Refrigerant collection device(collector) --Fig. 24

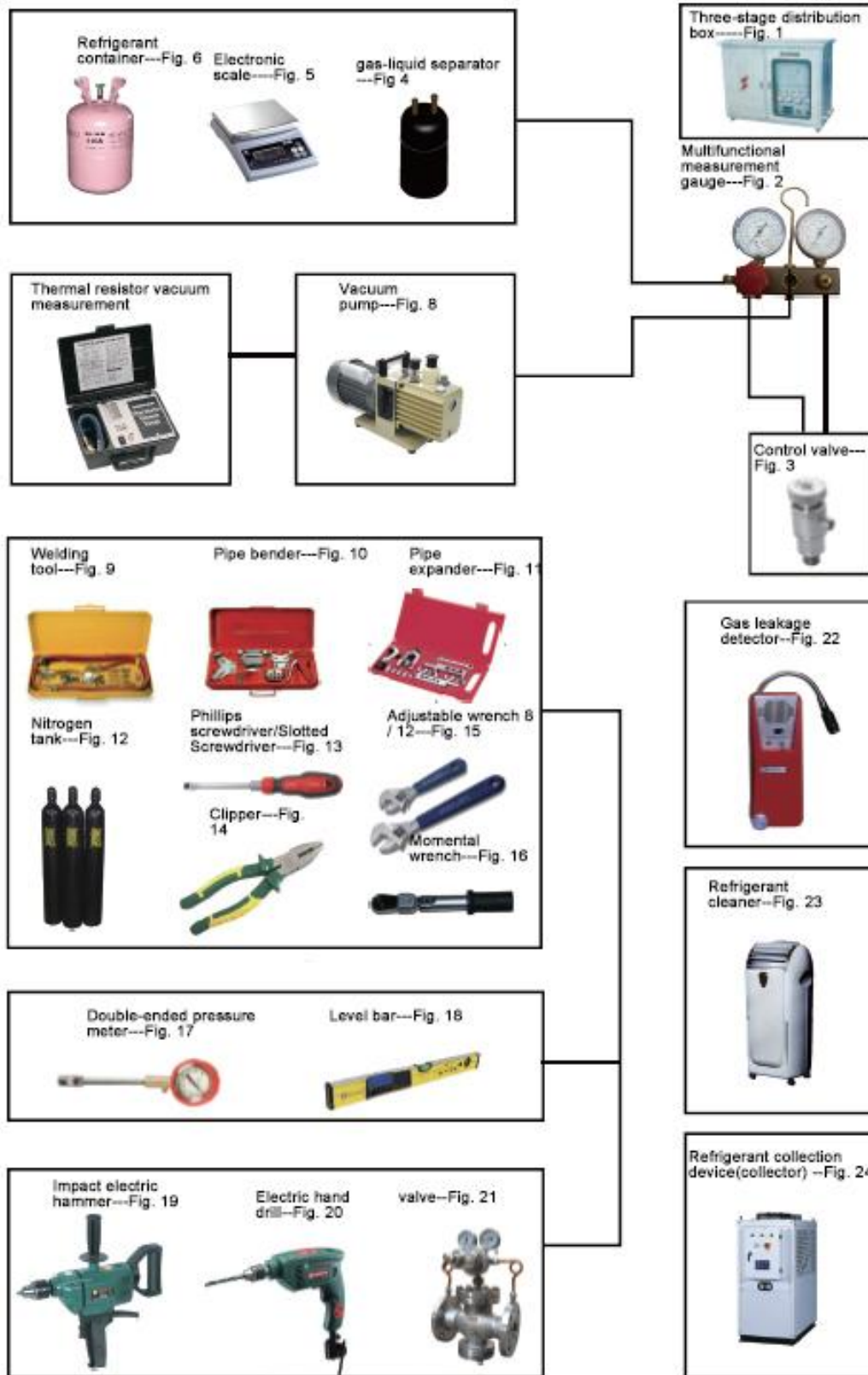

Note:
All tools shall comply with related safety qualification.

3. Preparation before Installation

3.1 Notices for Installation Engineering

3.1.1 Safety requirements for installation engineering



Warning! All personnel involved in the installation must attend safety education courses and pass corresponding safety examinations before installation. Only qualified personnel can attend the installation. Relevant personnel must be held responsible for any violation of the regulation.



Warning! Personnel and property safety are highly concerned during the entire installation process. Installation implementation must abide by relevant national safety regulations to ensure personnel and property safety.

3.1.2 Importance of installation engineering

VRF air conditioning systems use refrigerant, instead of other agent, to directly evaporate to carry out the system heat. High level of pipe cleanness and dryness is required in the system. When preparing and laying out various pipes onsite, if impurities, water, or dust is still inside refrigerant pipes or there is impurities and air inside the water system pipeline due to improper installation, various problems may occur in the system or even lead to system breakdown.

Problems that usually occur during installation are as follows:

No.	Installation Problem	Possible Consequence
1	Dust or impurities enter into the refrigeration system.	Pipes are blocked; air conditioning performance is reduced; compressor wear is increased or even hinder the normal operation of the system and burn the compressor.
2	Nitrogen is not filled into the refrigerant pipe or insufficient nitrogen is filled before welding.	Pipes are blocked; air conditioning performance is reduced; compressor wear is increased or even hinder the normal operation of the system and burn the compressor.
3	The vacuum degree in the refrigerant pipe is insufficient.	The refrigeration performance is reduced. The system fails to keep normal operation due to frequent protection measures. When the problem getting serious, compressor and other major components can be damaged.
4	Water enters into the refrigeration pipe.	Copper plating may appear on the compressor and reduce the compressor efficiency with abnormal noise generated; failures may occur in the system due to ice plug.
5	The refrigerant pipe specifications do not meet the configuration requirements.	Smaller configuration specifications can increase the system pipe resistance and affect the cooling performance; larger configuration specifications are waste of materials and can also reduce the cooling performance.
6	Refrigerant pipe is blocked.	The cooling performance is reduced; in certain cases, it may cause long-term compressor operating under overheat conditions; the lubricating effect can be affected and the compressor may be burnt if impurities were mixed with the lubricating oil.
7	Refrigerant pipe exceeds the limit.	The loss in pipe is considerable and the unit energy efficiency decreases, which are harmful for long-term running of the system.
8	Incorrect amount of refrigerant is filled.	The system cannot correctly control the flow allocation; the compressor may be operating under over-heating environment or running when the refrigerant flows back to the compressor.
9	The refrigerant pipe leaks.	Insufficient refrigerant circulating in the system decreases the cooling performance of the air conditioner. Long-term operation under such circumstance may cause an overheating compressor or even damage the compressor.
10	Water drainage from the condensate water pipe is not smooth.	Residual water in IDUs can affect the normal operation of the system. The possible water leakage can damage the IDU's decoration.
11	The ratio of slop for condensate water pipe is insufficient or the condensate water pipe is incorrectly connected.	Reverse slop or inconsistent connection of condensate water pipe can hinder the smooth drainage and cause leakage of the IDU.
12	The air channel is improperly fixed.	The air channel will deform; vibration and noise occur during unit operating.

GMV5 Home DC Inverter Multi VRF Units

13	The guide vane of air channel is not reasonably manufactured.	Uneven air quantity allocation reduces the overall performance of the air conditioner.
14	The refrigerant pipe or condensate water pipe does not meet the insulation requirement.	Water can easily condensate and drip to damage the indoor decoration, or even trigger the protection mode of system due to overheating operation.
15	The installation space for IDU is insufficient.	Since there is a lack of space for maintenance and checking, indoor decoration might need to be damaged during such operation.
16	The IDU or the location of the air outlet or return air inlet is not designed reasonably.	The air outlet or return air inlet may be short-circuited, thus affecting the air conditioning performance.
17	The ODU is installed in an improper place.	The ODU is difficult to be maintained; unit exhaust is not smooth, which reduces the heat exchanging performance or even prevent the system from normal operation; in addition, the cold and hot air for heat exchange and the noise may annoy people in surrounding areas.
18	Power cables are incorrectly provided.	Unit components may be damaged and potential safety hazard may occur.
19	Control communication cables are incorrectly provided or improperly connected.	The normal communication in the system fails or the control over IDUs and ODUs turn in a mess.
20	Control communication cables are not properly protected.	The communication cables are short-circuited or disconnected, and the unit cannot be started up due to communication failure.
21	Circulating inlet/outlet pipe of hydro box is blocked; floor heating pipe is blocked; water pipe at user side is blocked; or there are impurities in water system;	Water heating/floor heating effect gets worse; pump of hydro box is broken or hydro box occurs water flow switch protection or the complete unit occurs high pressure protection;
22	There is air in the circulating inlet/outlet pipe of hydro box; there is air in the floor heating pipe; there is air in the water pipe at user side; there is air in the water tank;	Water heating/floor heating effect gets worse; pump of hydro box is broken or hydro box occurs water flow switch protection or the complete unit occurs high pressure protection;
23	Auto vent valve is not installed at the top of water system	There is air in the waterway. Water heating/floor heating effect gets worse; pump of hydro box is broken or hydro box occurs water flow switch protection or the complete unit occurs high pressure protection;
24	The hydro box is not installed in indoor places	When the temperature is winter is too low, the hydro box may get frozen easily;
25	Insulation hasnt been done to the water system pipeline	When the temperature is winter is too low, the hydro box may get frozen easily;
26	The resistance of floor heating water system is too big, but engineering water pump is not installed	Floor heating effect gets worse and floor heating engineering water pump shall be installed;
27	Floor heating embedded pipe hasnt been designed according to the requirement; the distance between two floor heating pipes is too big or the diameter of floor heating pipe is too small	Floor heating effect gets worse and energy consumption increases;
28	Water makeup pipe of circulating water of hydro box hasnt installed pressure relief device	The water pressure inside circulating pipe of hydro box is too big; safety valve of hydro box leaks and causes water accumulation, which affects water heating effect;
29	When the hydro box is connected to the water tank or floor heating, waterway solenoid valve C and valve D haven't been installed; or the selected solenoid valve is not straight through, whose resistance is too big	Water heating/floor heating effect gets worse and energy consumption increases;

Understand the special requirement (if any) for unit installation before implementation to ensure installation quality. Relevant installers must have corresponding engineering construction qualifications. Special type operators involved in the engineering implementation, such as welders, electricians, and refrigeration mechanics must have relevant operating licenses and are accredited with vocational qualification certification.

3.1.3 Cooperation between different professions

A quality installation of air conditioning engineering depends on careful organization and close

cooperation between different professions such as architecture, structure, electric, water supply and drainage, fire-fighting, and decoration. Pipes must be laid in places away from any automatic spray head for fire-fighting, and must be reasonably arranged to ensure that the pipes fit the electric, luminaries, and decoration.

3.1.3.1 Requirements for cooperation with civil engineering:

- 1) The riser should be installed in the air conditioning tube well, and the horizontal pipe should be placed in the ceiling, if possible.
- 2) A place should be reserved for the ODU base to prevent the waterproof layer or insulating layer on the roof from being damaged in later phase of installation.
- 3) At places on walls or floors where pipes need to go through, holes or casing should be preserved. If the pipe needs to go through a bearing beam, a steel casing must be prepared.

3.1.3.2 Requirements for cooperation with decoration engineering:

- 1) The air conditioning installation should not damage the bearing structure or the decorative style. Air conditioning pipes should be laid out along the bottom of the beam as possible. If pipes meet one another at the same elevation, process based on the following principles:
 - 2) Air conditioning pipes should be laid out along the bottom of the beam as possible. If pipes meet one another at the same elevation, process based on the following principles:
 - (1) Drain pipes, air ducts and pressure pipes should leave places for gravity pipes;
 - (2) Air ducts and small pipes should leave places for major pipes.

3.1.3.3 Requirements for cooperation with electric:

After the capacity of air conditioning unit is determined, check the following aspects with relevant electric design personnel:

- 1) Whether the electrical load is designed based on the requirement of the air conditioning unit;
- 2) Whether the power cable and circuit breaker meet the unit requirement and abide by relevant national safety regulations;
- 3) Whether the regional power supply quality (including voltage fluctuation and interference noise) meet the international requirement.

Any nonconformity must be resolved through coordination.

3.2 Onsite Review of Design Drawing

Installation personnel must carefully read and understand the design scheme and drawings provided by engineering designers, and prepare detailed and feasible construction organization design after reviewing the onsite status.

The following aspects of working drawing must be reviewed:

GMV5 Home DC Inverter Multi VRF Units

No.	Content	Result
1	The loads of indoor and ODUs must match. The gross rated capacity of the IDU should be set to a value that is 80% to 100% of the rated capacity of the ODU. In actual conditions, if the capacity of concurrently operating IDUs exceeds 100% of the rated capacity of the ODU, the air conditioning system fails to meet the requirement. Note: Configuration in excess of the capacity of the IDUs can affect the comfort for users. The more the excess is, the lower the adjustment capacity of an air conditioning unit will be and even the system reliability can be affected. Therefore, relevant regulations on capacity limit must be strictly followed.	<input type="checkbox"/> Passed <input type="checkbox"/> Failed
2	If the refrigerant pipe design complies with the operation requirement of unit: 1) The total length of refrigerant pipe shall comply with the design requirement of unit; 2) Height difference between IDU and ODU If ODU is installed higher than IDU, max height difference H40m; If ODU is installed lower than IDU, max height difference H50m; 3) The refrigeration system pipe diameter, branch pipe model shall comply with technical requirements.	<input type="checkbox"/> Passed <input type="checkbox"/> Failed
3	The drainage method of unit condensate water pipe must be reasonable; the pipeline slope must follow the design requirement of unit.	<input type="checkbox"/> Passed <input type="checkbox"/> Failed
4	If the installation of unit complies with the requirement of installation space	<input type="checkbox"/> Passed <input type="checkbox"/> Failed
5	The air duct of IDU is reasonably organized.	<input type="checkbox"/> Passed <input type="checkbox"/> Failed
6	The configuration specifications, type, and control method of power cables should meet the design requirement of unit	<input type="checkbox"/> Passed <input type="checkbox"/> Failed
7	The arrangement, total length, and control method of control line should meet the design requirement of unit.	<input type="checkbox"/> Passed <input type="checkbox"/> Failed
8	If the installation of hydro box complies with the requirement of installation space	<input type="checkbox"/> Passed <input type="checkbox"/> Failed
9	If the installation of water tank complies with the requirement of installation space	<input type="checkbox"/> Passed <input type="checkbox"/> Failed
10	If the installation of floor heating pipe complies with the installation requirement	<input type="checkbox"/> Passed <input type="checkbox"/> Failed
11	If the installation of floor heating water separator and water collector complies with the installation requirement when connecting the floor heating pipe	<input type="checkbox"/> Passed <input type="checkbox"/> Failed
12	If the installation of pressure difference bypass valve between floor heating separator and water collector complies with the installation requirement	<input type="checkbox"/> Passed <input type="checkbox"/> Failed
13	If the electric connection of floor heating engineering pump and floor heating electric performer complies with the requirement of circuit diagram of hydro box	<input type="checkbox"/> Passed <input type="checkbox"/> Failed
14	If the connection of temperature sensor of hydro box complies with the requirement of circuit diagram of hydro box	<input type="checkbox"/> Passed <input type="checkbox"/> Failed
15	If the installation of user water return pump complies with the installation requirement and requirement of circuit diagram	<input type="checkbox"/> Passed <input type="checkbox"/> Failed
16	If the installation of water system pipeline complies with the installation requirement Install the water system pipeline according to the connection schematic diagram, make good insulation measure and install vent valve, etc.	<input type="checkbox"/> Passed <input type="checkbox"/> Failed
17	If the installation of water makeup pipe of circulating water of hydro box complies with the installation requirement Pressure relief valve, filter, etc. shall be installed	<input type="checkbox"/> Passed <input type="checkbox"/> Failed
18	If the matching of ODU, IDU, hydro box and water tank complies with the requirement	<input type="checkbox"/> Passed <input type="checkbox"/> Failed



Note: Engineering construction personnel must strictly abide by the design drawings. If any design cannot be implemented during construction and needs to be modified, contact the designer first for approval and prepare a written document, that is, the design modification record.

3.3 Selection of Installation Materials

3.3.1 Notices for selecting installation materials

- 1) The materials, equipment and instruments used during air conditioning engineering construction must have certifications and test reports.
- 2) Products with fireproof requirements must be provided with fireproof inspection certificates

and must meet national and relevant compulsory standards.

3) If environmentally-friendly materials are to be used as required by customers, all such materials must meet national environmental protection requirement and be provided with relevant certificates.

3.3.2 Requirements for selecting installation materials

3.3.2.1 Copper pipe

1) Dephosphorization drawing copper pipe with tensile strength not less than 240kgf/mm² must be used;

2) Specifications requirement:

R410A Refrigerant System		
Outer diameter(mm/inch)	Wall thickness(mm)	Model
Φ6.35(1/4)	≥0.8	0
Φ9.52(3/8)	≥0.8	0
Φ12.70(1/2)	≥0.8	0
Φ15.9(5/8)	≥1.0	0
Φ19.05(3/4)	≥1.0	0
Φ22.2(7/8)	≥1.2	1/2H
Φ25.40(1/1)	≥1.2	1/2H
Φ28.60(9/8)	≥1.2	1/2H

Note:

- ① Appearance requirement: The inner and outer surface of pipe should be smooth without pinhole, crack, peeling, blister, inclusion, copper powder, carbon deposition, rust, dirt or severe oxide film, and without obvious scratch, pit, spot and other defects.
- ② After the inner part of the copper pipe is cleaned and dried, the inlet and outlet must be sealed tightly by using pipe caps, plugs or adhesive tapes.

3.3.2.2 Condensate water pipe

1) Pipes that can be used for air conditioner drainage include: water supplying UPVC pipe, PP-R pipe, PP-C pipe, and HDG steel pipe;

2) Requirements for specifications and wall thickness

(1) Water supplying UPVC pipe: Φ32mm×2mm, Φ40mm×2mm, Φ50mm×2.5mm;

(2) HDG steel pipe: Φ25mm×3.25mm, Φ32mm×3.25mm, Φ40mm×3.5mm, Φ50mm×3.5mm.

3.3.2.3 Insulation material

1) Rubber foam insulation material;

2) Specifications and requirements

(1) Flame retardancy level: B1 or higher;

(2) Refractoriness: at least 120°C;

(3) The insulation thickness of condensate water pipe: at least 10 mm;

(4) When the diameter of copper pipe is equal to or greater than Φ15.9 mm, the thickness of insulation material should be at least 20 mm; when the diameter of copper pipe is less than 15.9 mm, the thickness of insulation material should be at least 15 mm.

3.3.2.4 Water system pipe (circulating pipe of hydro box and water inlet and outlet pipe of water tank)

- 1) Circulating pipe of hydro box: Hot water pipe must be used. The PPR pipe with outer diameter DN25 which is S2.5 series (thickness is 4.2mm) is recommended.
- 2) Water inlet and outlet pipe of water tank: Hot water pipe must be used. The PPR pipe with outer diameter DN20 which is S2.5 series (thickness is 3.4mm) is recommended.
- 3) All applied PPR pipes must comply with national standards GB/T18742. If other insulated pipeline are adopted, the above can be reference.
- 4) The water system pipes must be insulated. Usually, the thickness of heat insulating material is 15mm; the outdoor or exposed pipe shall be wrapped for beautiful appearance.

3.3.2.5 Floor heating pipe

- 1) The floor heating pipe shall comply with level 4 in national standards GB/T 18891.
- 2) The pipe quality and mechanical property must comply with related national standard.
- 3) The floor heating pipe shall be with oxygen barrier layer.
- 4) The operation pressure of floor heating pipe shall not be less than 0.4MPa.
- 5) Applicable pipe types: PE-RT pipe, PE-X pipe and so on.
- 6) Pipe size: DN16, DN20 and so on.
- 7) The distance between two floor heating pipes shall be within 100~150mm.
- 8) The main floor heating pipe must be insulated. Usually, the thickness of heat insulating material is 15mm; the outdoor or exposed pipe shall be wrapped for beautiful appearance.

3.3.2.6 Communication cable



Note: For air conditioning units installed in places with strong electromagnetic interference, shielded wire must be used as the communication cables of the IDU and wired controller, and shielded twisted pairs must be used as the communication cables between IDUs and between the IDU and ODU.

Communication cable selection for ODU and IDUs

Wire Type	Total Length of Communication Cables Between IDU and IDU (ODU) L(m)	Number of Wire Pieces x Wire Diameter (mm ²)	Wire Standard	Remark
Common sheath twisted pair copper core	L≤1000	≥2×0.75	GB/T 5023.3-2008	If the wire diameter is enlarged to 2×1mm ² , the overall communication length can reach 1500m.

Communication cable selection for IDU and wired controller

Wire Type	Total Length of Communication Cables Between IDU and Wired Controller L(m)	Number of Wire Pieces x Wire Diameter (mm ²)	Wire Standard	Remark
Common sheath twisted pair copper core	L≤250	≥2×0.75	GB/T 5023.3-2008	The overall communication length cannot exceed 250m.

3.3.2.7 Power cable

Only copper conductors can be used as power cables. The copper conductors must meet relevant national standard and satisfy the carrying capacity of unit.

4 Three Operation Modes

4.1 Operation mode 1: Air conditioning + water heating

This solution can satisfy large demand for hot water. It is applicable for 4 or more persons or bathing:

Outdoor model		Indoor unit	Hydro box	Water tank
Top discharge	GMV-S224W/A-X GMV-S280W/A-X	Indoor units of GMV5	NRQD16G/A-S	Water tank with internal coil: SXVD200LCJ/A-K SXVD300LCJ/A-K SXVD350LCJ/A-K SXVD400LCJ/A-K (2) Solar power connectable water tank with internal coil: SXVD200LCJ2/A-K SXVD300LCJ2/A-K SXVD350LCJ2/A-K SXVD400LCJ2/A-K

Installation method:

Outdoor unit

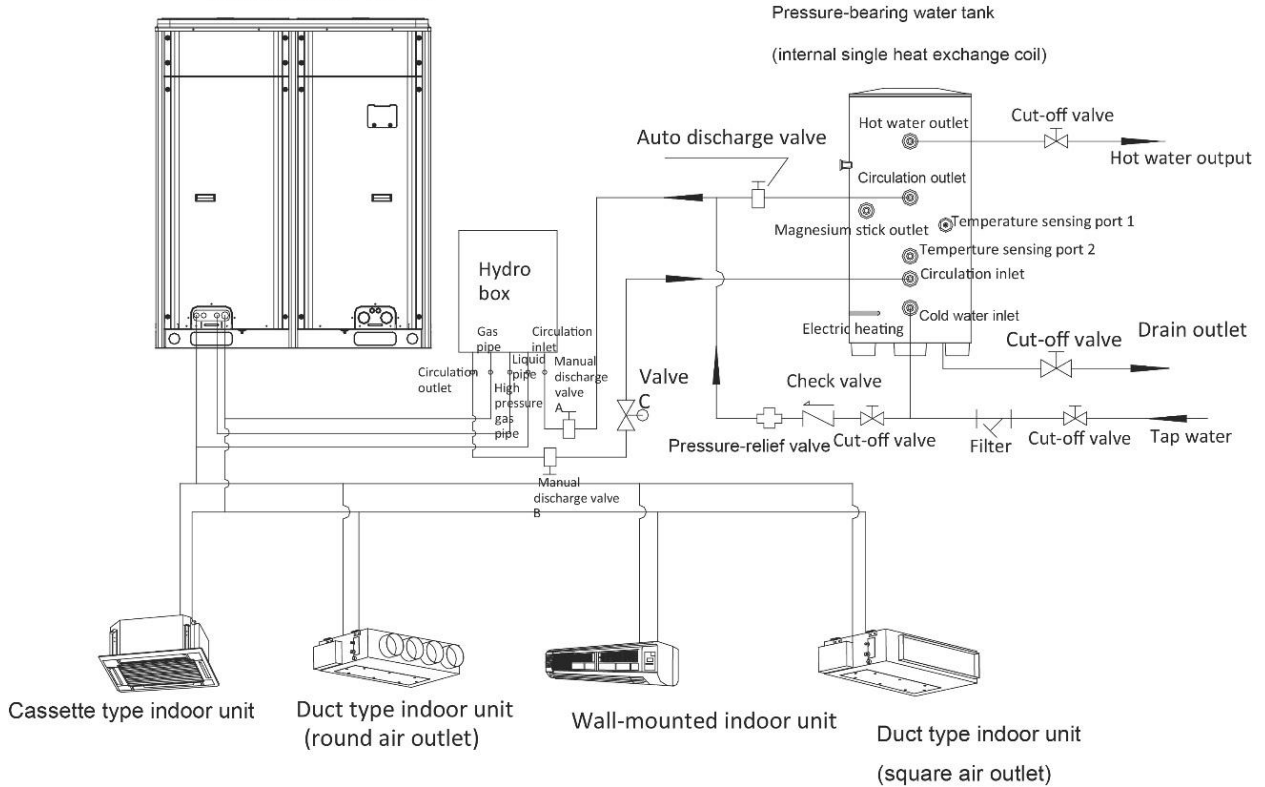

GMV5 Home DC Inverter Multi VRF Units

If solar power is to be connected, installation method is as below:

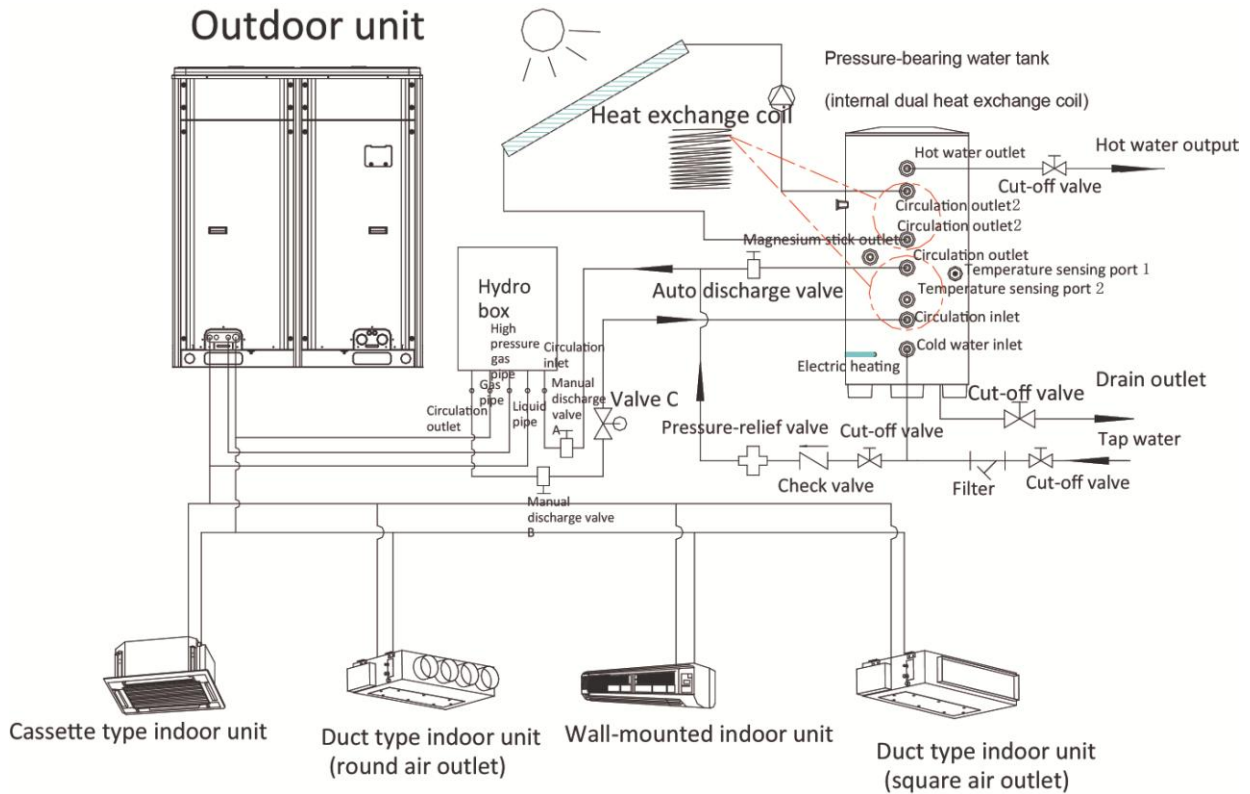

4.2 Operation mode 2: Air conditioning + water heating + floor heating

Outdoor model		Indoor unit	Hydro box	Water tank
Top discharge	GMV-S224W/A-X GMV-S280W/A-X	Indoor units of GMV5	NRQD16G/A-S	(1) Water tank with internal coil: SXVD200LCJ/A-K SXVD300LCJ/A-K SXVD350LCJ/A-K SXVD400LCJ/A-K (2) Solar power connectable water tank with internal coil: SXVD200LCJ2/A-KSXVD300LCJ2/A-K SXVD350LCJ2/A-K SXVD400LCJ2/A-K

Note:

Valve C and valve D should be straight-through electromagnetic water valve of small resistance. Valve C, valve D and floor heating actuator should all be normally closed.

Installation method:

Outdoor unit

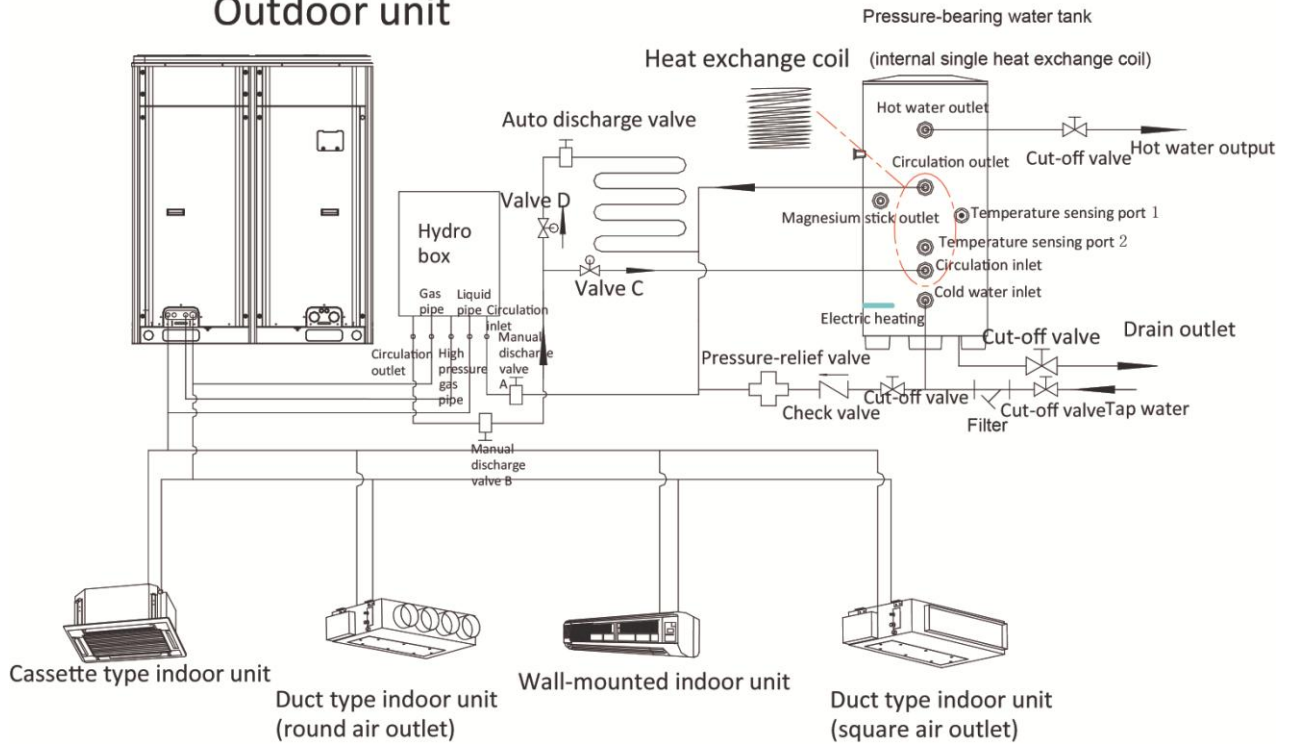

If solar power is to be connected, installation method is as below:

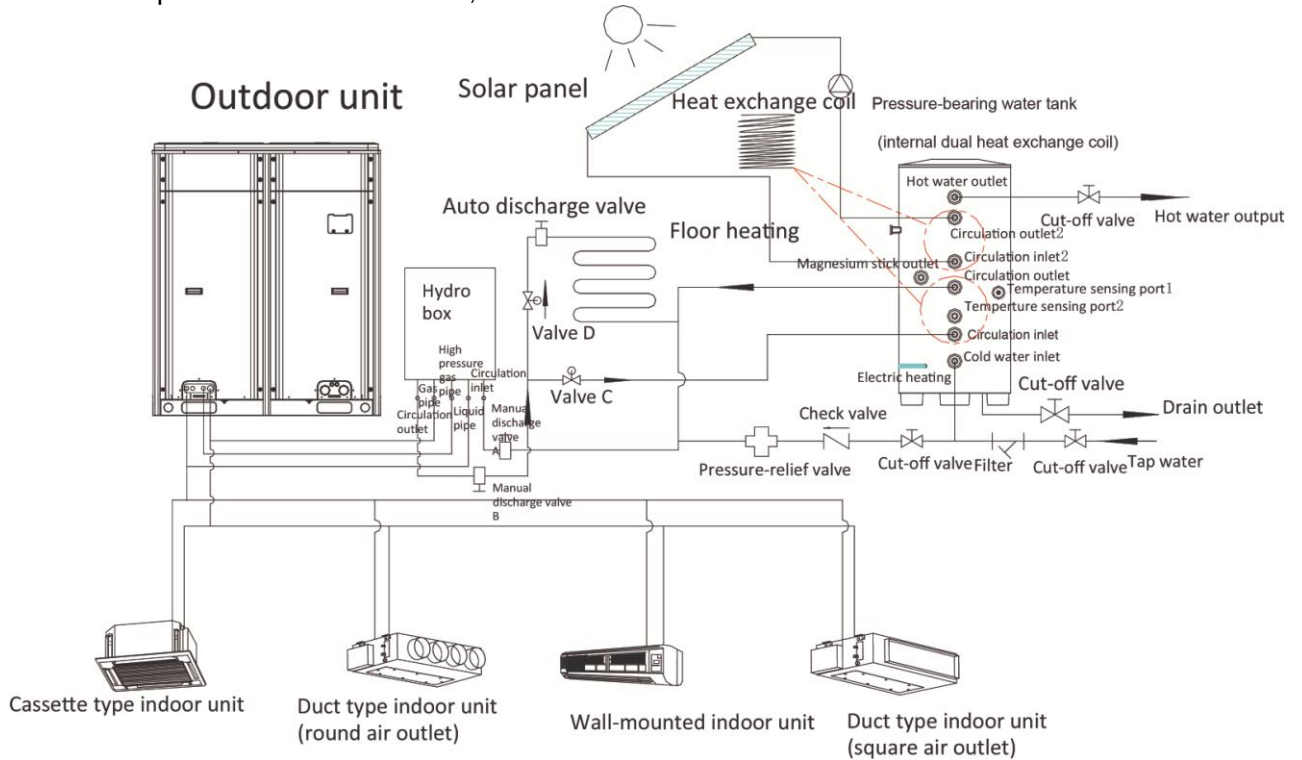

4.3 Operation mode 3: Air conditioning + floor heating

Operation mode 3: Air conditioning + floor heating			
	Outdoor model	Indoor unit	Hydro box
Top discharge	GMV-S224W/A-X GMV-S280W/A-X	Indoor units of GMV5	NRQD16G/A-S

Installation method:

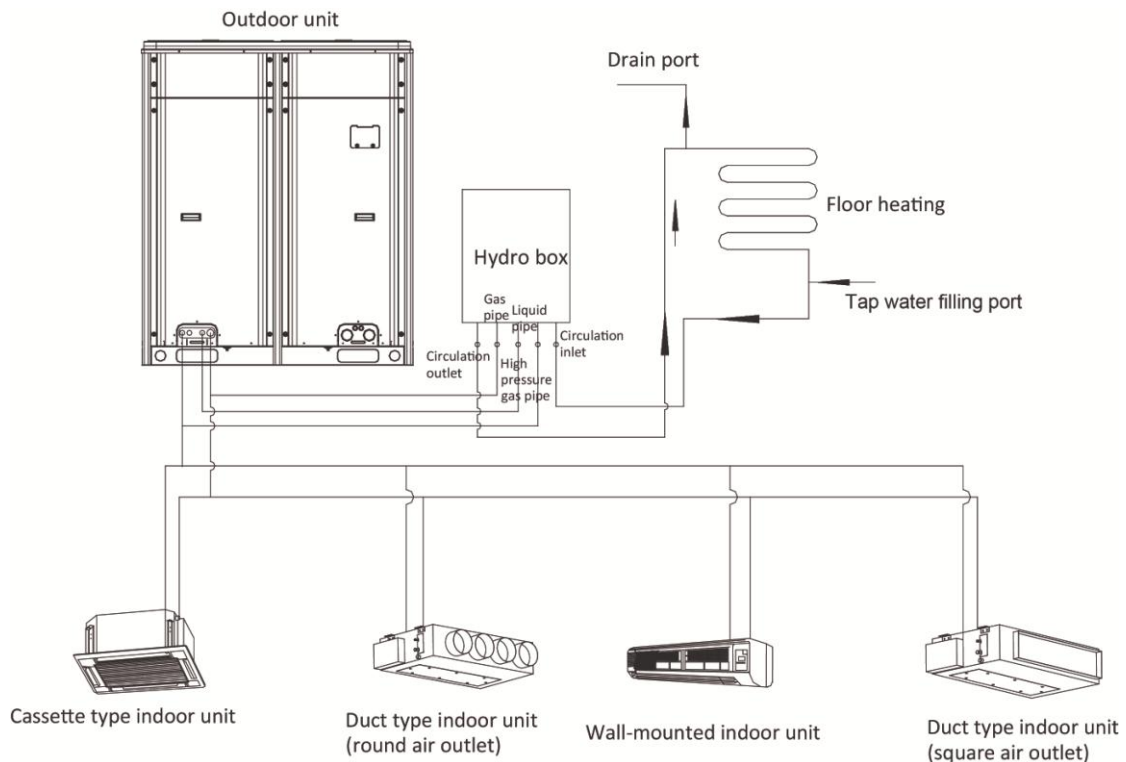

⚠ Notices:

Before installation and debugging, please read the following notices carefully!

- (1) Hydro box is only used for closed-type water system. For open-type water system such as water tank with no coil, please do not use hydro box. It should be installed indoors at ambient temperature of 4~35. Never install the hydro box outdoors, otherwise vibration will occur.
- (2) If units will be stopped or powered off for a long time, please drain away the water in the hydro box, water tank and floor heating pipeline, otherwise, units will get frozen. During installation, please install drain valve at the inlet and outlet pipe of hydro box to ensure water can be completely drained.
- (3) Before power is on, please check the main board if the DIP switch S2 is consistent with the actual condition of connected equipment. If it is not consistent, units reliability will be affected and temperature sensor error will occur.
- (4) If water replenishing pressure is larger than 3bar, please add pressure-relief valve at the water replenishing port to make sure water pressure is less than or equal to 3bar. Otherwise, pressure relief valve will be open and cause water leak.
- (5) For the connection of floor heating equipment, if pressure loss of water system outside hydro box is more than 6m, please add an engineering water pump.
- (6) Air conditioner wired controller can control floor heating. For the details of setting method and operation, please refer to the manual of hydro box and the manual of wired controller.
- (7) When connecting hydro box with water tank, please connect the circulation outlet of hydro box with the circulation inlet of water tank, and connect the circulation inlet of hydro box with the circulation outlet of water tank. Please refer to the manual of hydro box for installation details.

- (8) If you need to connect the hydro box with floor heating system or water tank, please install waterline solenoid valve C and solenoid valve D according to units installation diagram. The solenoid valves are used to control the heating of water tank and floor waterline. Valve C and valve D should be straight-through electromagnetic water valve of small resistance (Valve C and valve D are supplied for hydro box NRQD16G/A-S). Valve C, valve D and floor heating actuator should all be normally closed.
- (9) When floor heating is connected, its water system is different from the water system of water tank. Therefore, tap water filling port and drain port should be connected during the engineering setting.
- (10) User can require project engineer to add back water pump based on actual needs. This can maintain users water pipe temperature and avoid waste.
- (11) Water pipeline can only be installed after hydro box is installed securely. When installing the connection pipes, please prevent dust or other foreign matters from getting in the pipeline.
- (12) After the entire pipeline is connected, check if there is any leak. After ensuring that there is no leak, apply insulation treatment to the pipeline. Please pay special care to the insulation treatment of valves, pipe joints, and other joints. We suggest you use insulating cotton that is thicker than 15mm.
- (13) The temperature keeping and pressure bearing water tank depends on tap water pressure to supply hot water. Only when there is tap water will hot water be available. When user wants to use hot water, please keep the cut-off valve of water tank cold water inlet in open status.
- (14) Cooling and floor heating cannot be started at the same time. If floor heating cannot start working and Mode conflict is displayed, please turn indoor unit into heat mode or turn it off in heat mode.
- (15) The horizontal distance between hydro box and water tank should not exceed 5 meters and the vertical distance between them should not exceed 3 meters. If the distance exceeds above limits, please contact our company. Recommended installation method is to keep the water tank at lower side and the hydro box at upper side.
- (16) Please prepare installation materials according to above dimensions and specifications. If cut-off valve is installed outdoors, its better to use PPR pipe fittings to avoid the valve from being frozen under low temperature.

5. Installation of ODU

5.1 ODU Dimensions and Installation Hole Size

Outline dimension of GMV-S224W/A-X, GMV-S280W/A-X (Unit: mm):

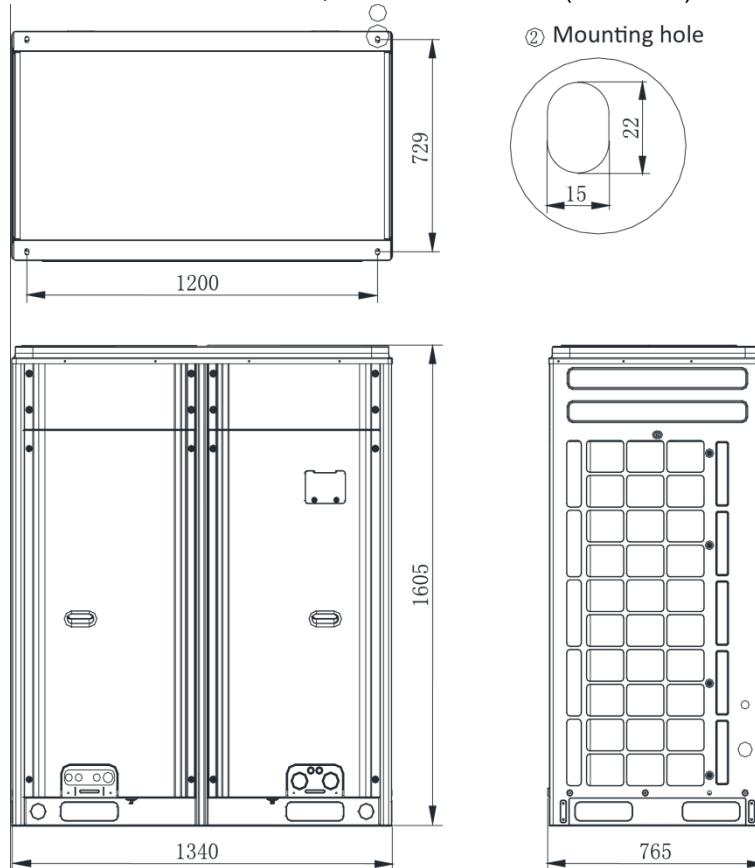

5.2 Selection of Outdoor Unit Installation Place

- ◆ The ODU should be installed near bedrooms, studies or meeting rooms;
- ◆ The installation place should be able to withstand the weight of outdoor unit;
- ◆ The installation place shall be ventilated to ensure there is no obstacle at air inlet and air outlet of unit and sufficient maintenance space is reserved;
- ◆ The installation place will not be embedded by snow and rain, and will not be affected by garbage and oil fog.

5.3 Installation Space Requirement for ODU

5.3.1 Installation space requirement for single-module unit

Basic installation space requirement for GMV-S224W/A-X, GMV-S280W/A-X (Unit: mm):

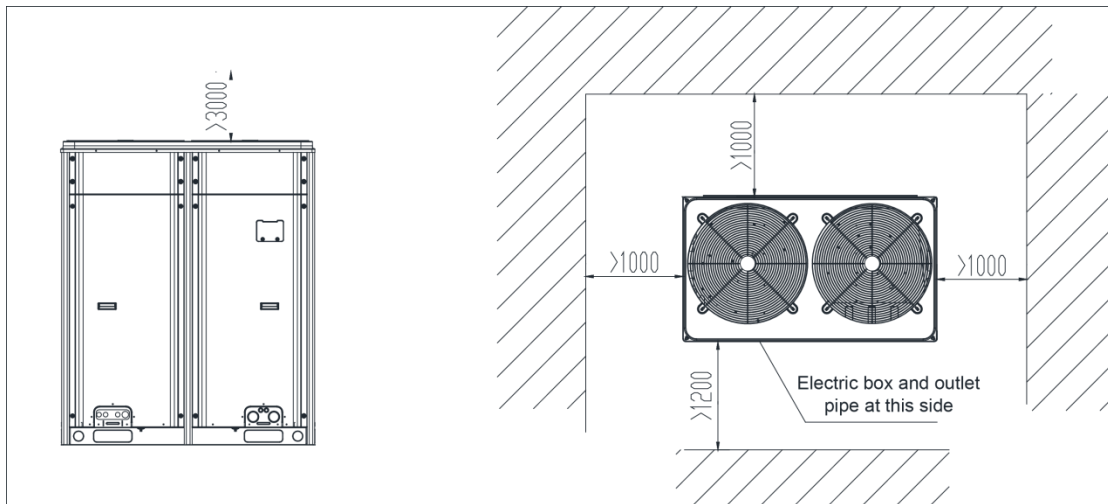

If there are walls at four sides of unit, please follow the above-mentioned basic space requirement;

In principle, if a crown wall (obstacles for keeping out the wind) exists over the machine, a distance of at least 3000mm should be left between the top of the machine and the crown wall. If the front, rear, left and right sides of the machine are open spaces, the distance between the top of the machine and the crown wall should be at least 1500mm. If the requirement for the minimum 1500 mm cannot be met, or the spaces around the machine are not open, an exhaust air duct needs to be connected to maintain smooth ventilation.

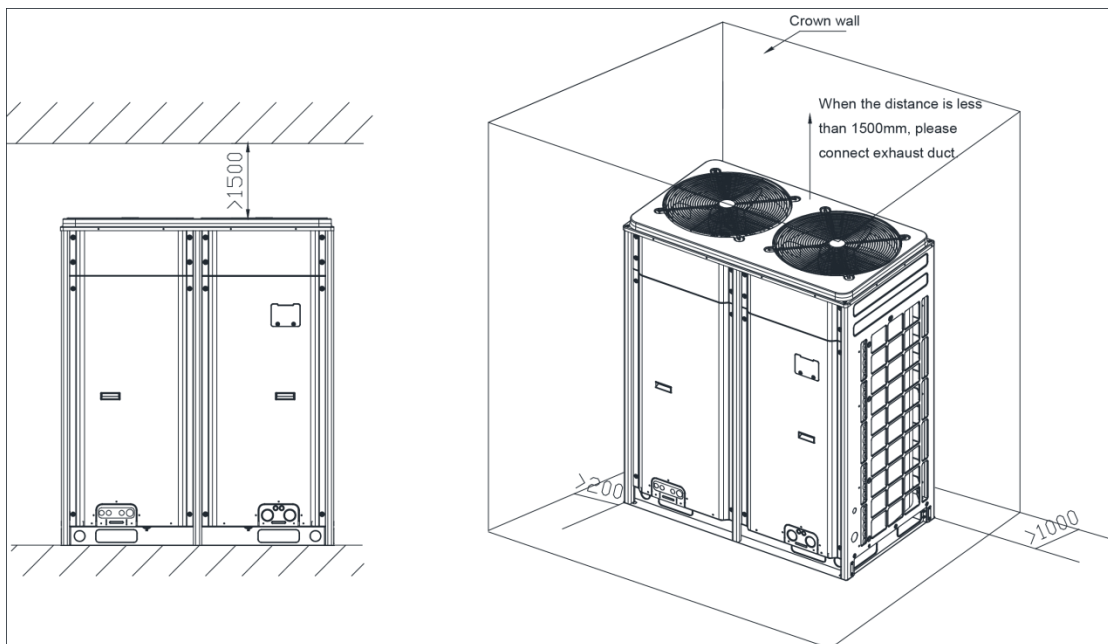

5.3.2 Monsoons must be considered during ODU installation

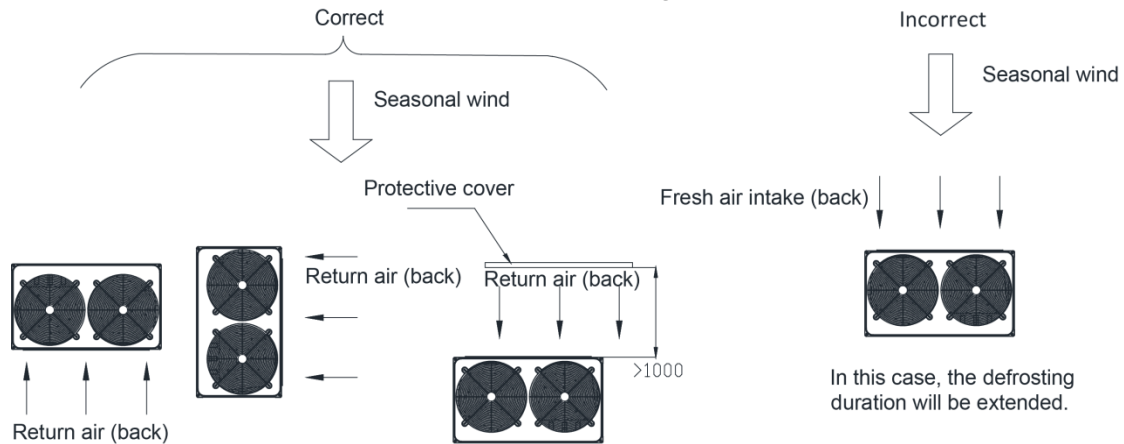

5.3.3 Snow must be considered during ODU installation.

In order to prevent covering the air supply and air return by snow, an air supply protective cover and air return protective cover and one foundation shall be applied.

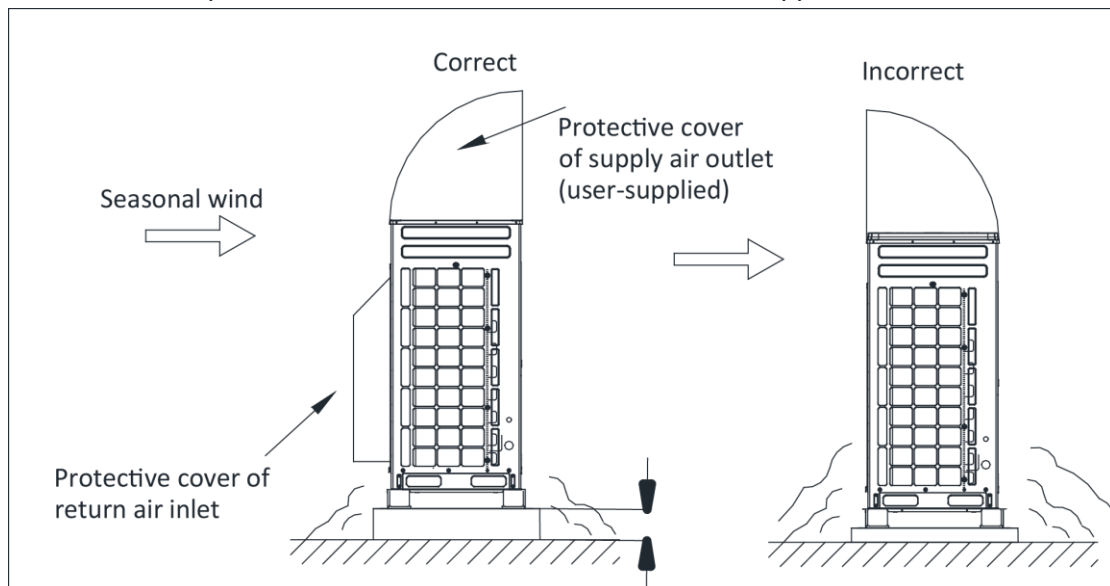

5.3.4 Installation space requirement for equipment floor

If the ODU is to be installed in the equipment floor, induced and exhaust air duct must be connected;

In the equipment floor, the opening rate of shutters must be at least 80%, and the angle between the shutters and the horizontal plane should be less than 20° .

5.3.4.1 Preparation before installing static pressure ventilating duct

- 1) The ODU is installed properly;
- 2) The steel-plate ventilating duct is designed based on the unit and engineering requirement, and is installed properly according to the engineering standards;
- 3) Based on the unit dimensions and the size of steel-plate ventilating duct, prepare materials such as canvas casing, tin foil, steel bar and tapping screw, as well as tools such as hand-operated electric drill, air screw driver and screwdriver.

5.3.4.2 Installation of pressure ventilating duct

Two methods are available to connect an ODU to static pressure ventilating duct, they are reserving the unit top cover and removing the unit top cover.

When the effective area of air inlet is less than 70% of the total air inlet area of outdoor unit, please introduce exhauster. The total air volume of exhauster shall not be less than 80% of total air inlet volume.

Method 1: Reserve the unit top cover and press the canvas casing with top cover. Detailed operations are as follows:

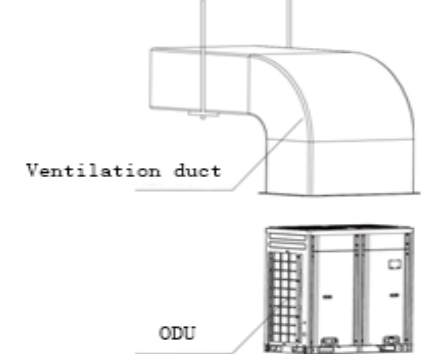
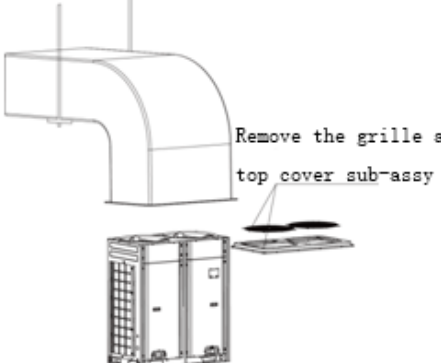
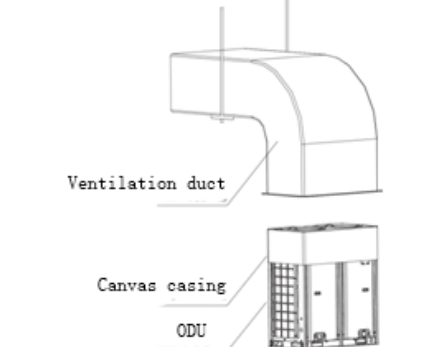
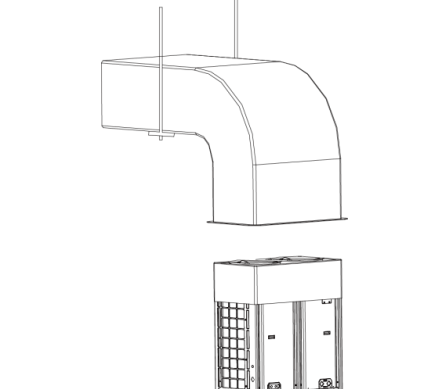
Procedures	Figure	Operation instruction	Remark
Step 1		<p>① Select the installation position of ODU and fix the ODU; ② Confirm the installation position of ventilation duct according to the position of ODU; ③ Make and install ventilation duct according to the figure at the left side.</p>	<p>① Material of ventilation duct: steel plate or sheet iron; ② Ventilation duct is prepared by the user.</p>
Step 2		<p>① Use an air screwdriver or screwdriver to unfasten the tapping screws that fixing the top cover sub-assy; ② Take out the grille from the top of top cover sub-assy.</p>	<p>Remove the grille on the top cover. Otherwise, the air volume, especially the unit operating performance will be affected;</p>
Step 3		<p>① Put the canvas casing inside out; cover one end of the canvas casing over the unit downward until the canvas end face is aligned with the unit or a bit higher than the top of the unit.</p>	
Step 4		<p>① Put the top cover back and tightly press the canvas casing; ② Use tapping screws to fix the top cover onto the unit.</p>	

GMV5 Home DC Inverter Multi VRF Units

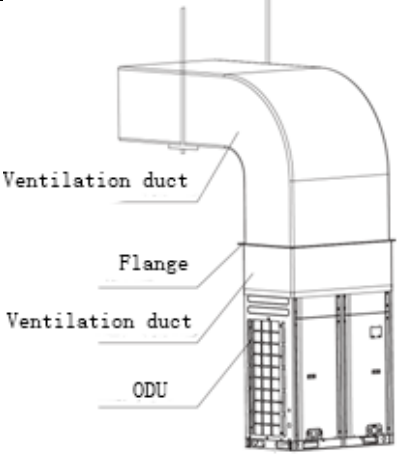
<p>Step 5</p>		<ol style="list-style-type: none"> ① Pull up the canvas casing reversely and use the steel bar to press the canvas casing tightly onto the counter flange of the steel-plate ventilation duct; ② Use a hand-operated electric drill to drill holes and fasten the parts by using tapping screws; ③ Use the tin foil to seal the joints and check the joints' reliability. 	
---------------	---	--	--

Method 2: Reserve the unit top cover and press the canvas casing with external steel bar. Detailed operations are as follows:

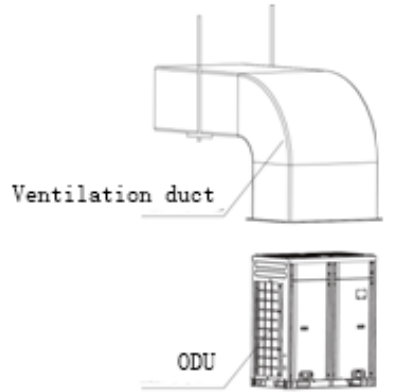
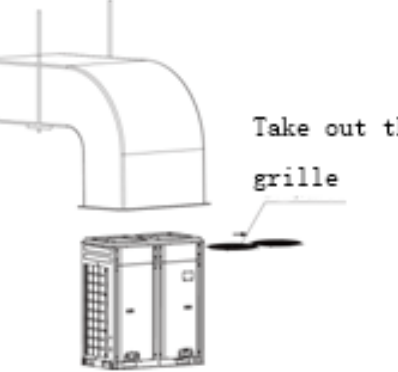
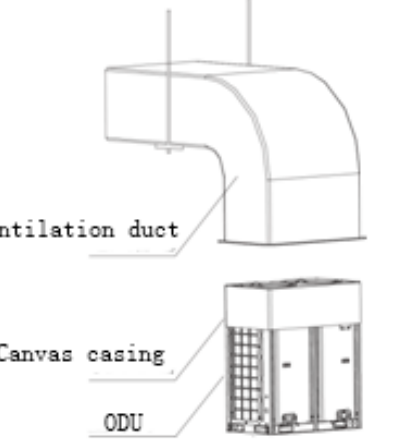
Procedures	Figure	Operation instruction	Remark
<p>Step 1</p>		<ol style="list-style-type: none"> ① Select the installation position of ODU and fix the ODU; ② Confirm the installation position of ventilation duct according to the position of ODU; ③ Make and install ventilation duct according to the figure at the left side. 	<ol style="list-style-type: none"> ① Material of ventilation duct: steel plate or sheet iron; ② Ventilation duct is prepared by the user.
<p>Step 2</p>		<ol style="list-style-type: none"> ① Take out the grille from the top of the top cover sub-assy. 	<p>Remove the grille on the top cover. Otherwise, the air volume, especially the unit operating performance will be affected.</p>
<p>Step 3</p>		<ol style="list-style-type: none"> ① Use the prepared canvas casing inside out to cover the surroundings over the top of the unit. Keep the top of canvas casing 30mm to 50mm higher over the top of the unit. 	

GMV5 Home DC Inverter Multi VRF Units

Step 4		<p>① Use a steel bar to press tightly the canvas casing around the top cover of the unit. Use a hand-operated electric drill to drill holes and fasten the canvas casing onto the unit through steel bar by using tapping screws.</p>	<p>For method 2, since drills are required on the top cover, the powder coated protective layer on the top cover will be damaged. As a result, the anti-corrosion performance of the unit top cover will be reduced.</p>
Step 5		<p>① Pull up the canvas casing reversely and use the steel bar to press the canvas casing tightly onto the counter flange of the steel-plate ventilating duct;</p> <p>② Use a hand-operated electric drill to drill holes and fasten the parts by using tapping screws;</p> <p>③ Use the tin foil to seal the joints and check the joints' reliability.</p>	

5.4 Installation Foundation of ODU

The concrete foundation of the ODU must be strong enough. Ensure that the drainage is smooth and that the ground drainage or floor drainage is not affected.

Requirements on the concrete foundation are as follows:

- 1) The concrete foundation must be flat and have enough rigidity and strength to undertake the unit's weight during running. The height of the foundation is 200 mm to 300 mm, which is determined based on the size of the unit;
- 2) The proportion of the cement, sand, and stone for the concrete is 1:2:4. Place 10 reinforced steel bars ($\phi 10$ mm) with a space between of 30 mm;
- 3) Use the mortar to flatten the surface of the foundation. Sharp edges must be chamfered;
- 4) When the foundation is built on a concrete floor, crushed stones are not required. But the foundation surface must be roughened;
- 5) Clear the oil stains, crushed stones, dirt, and water in the reserved bolt hole of the foundation and install a temporary cover before installing bolts;
- 6) Build a drainage ditch around the foundation to discharge the condensate water;
- 7) If the air conditioner is installed on the roof, check the intensity of the building and take waterproof measures;
- 8) If a u-steel foundation is adopted, the structure must be designed with sufficient rigidity and strength.

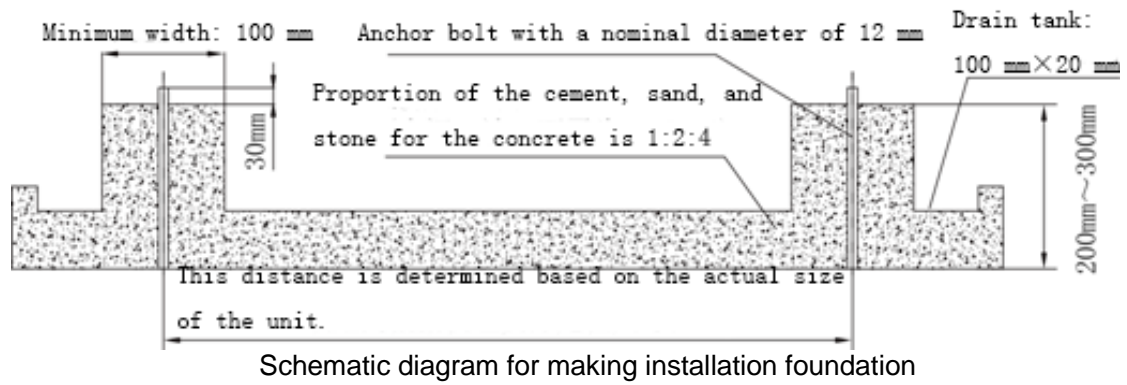

5.5 Vibration Reduction for ODU

The ODU must be fixed securely. Apply a thick rubber sheet or corrugated damping rubber pad with thickness of 200 mm or more and width of 100 mm or more between the ODU and the foundation, as shown in the following figures.

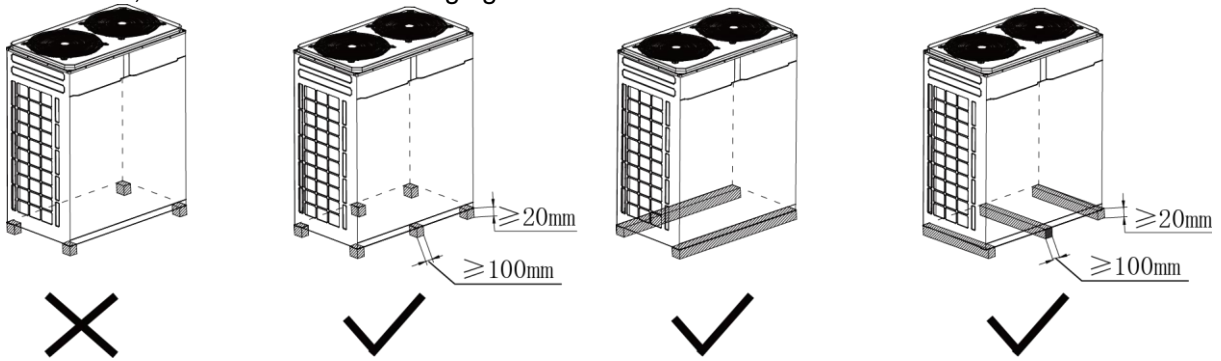

6. Installation of IDU

Please refer to the related manual of IDU.

7. Installation of Hydro Box

7.1 Outline dimension and installation hole dimension of hydro box

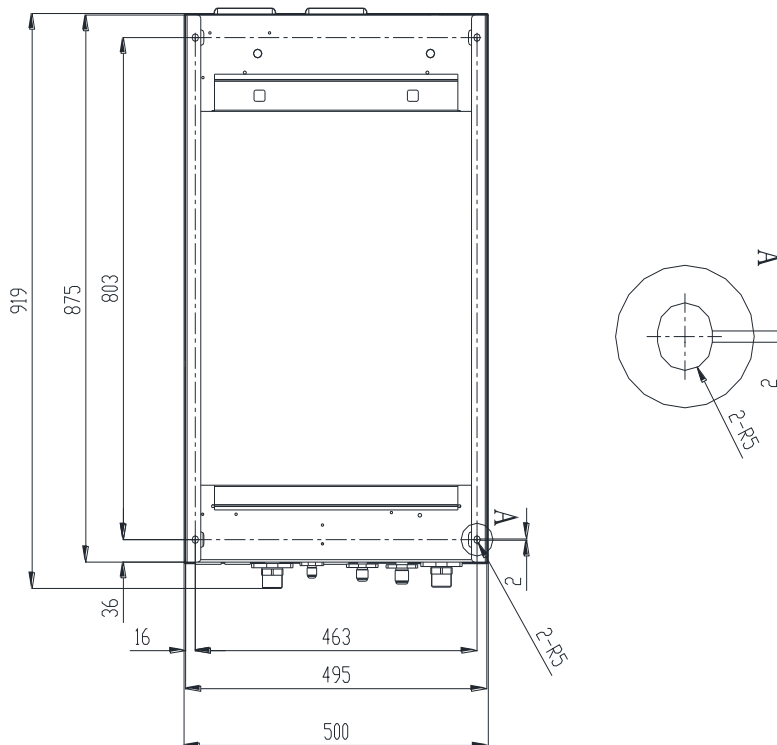

7.2 Installation Position of Hydro Box

- ◆ The hydro box shall be installed indoors with ambient temperature from 4°C~35°C. Prohibit install the hydro box outdoors. Otherwise, malfunction may be caused;
- ◆ The hydro box must be vertically installed facing upwards and wall-mounted installation method shall be adopted;
- ◆ The installation place should be able to withstand the weight of hydro box;
- ◆ The installation position shall be well ventilated to ensure there is no obstacle at the top grille of unit and sufficient maintenance space shall be reserved;
- ◆ The hydro box shall not be affected by garbage and oil fog.

7.3 Requirements for Installation Space of Hydro Box (Unit: mm)

The hydro box must be vertically installed facing upwards and wall-mounted installation method shall be adopted.

GMV5 Home DC Inverter Multi VRF Units

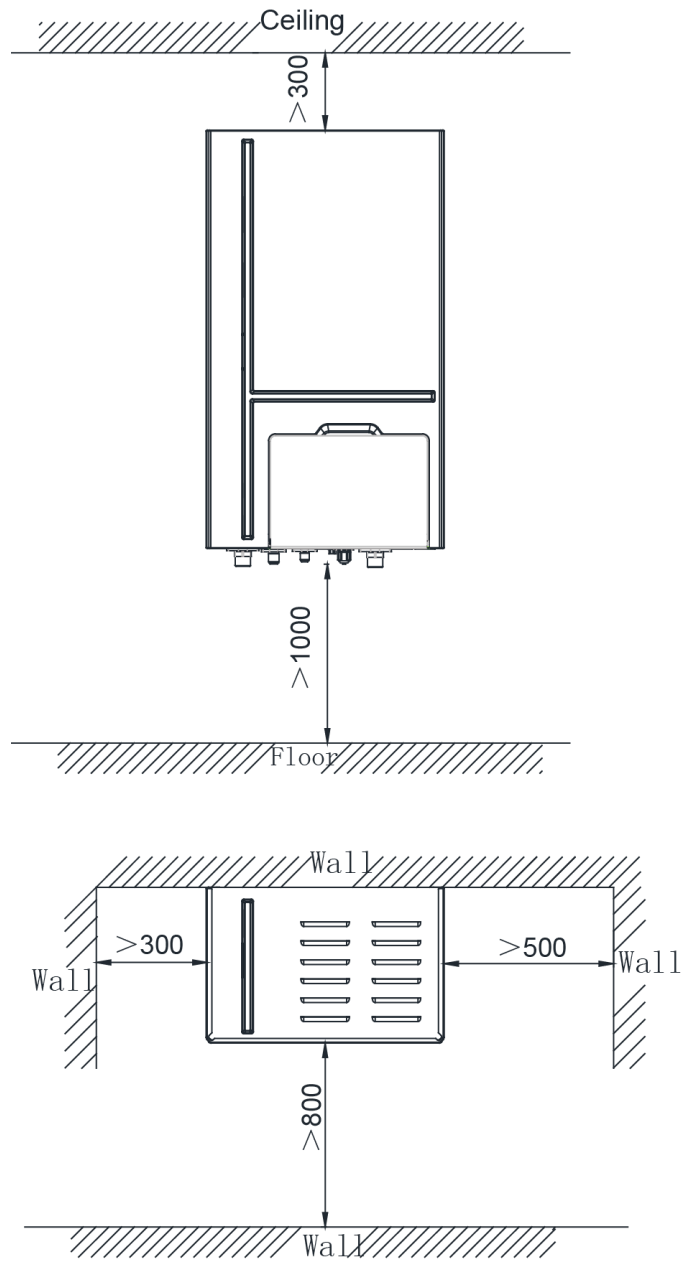

7.4 Installation Procedures of Hydro Box

Installation steps:

Step 1: Open the panel cover; remove the installation support screw of wired controller; take out the wired controller and its support; disconnect the connection wire of wired controller.

Remove the screw and disconnect the connection wire of wired controller

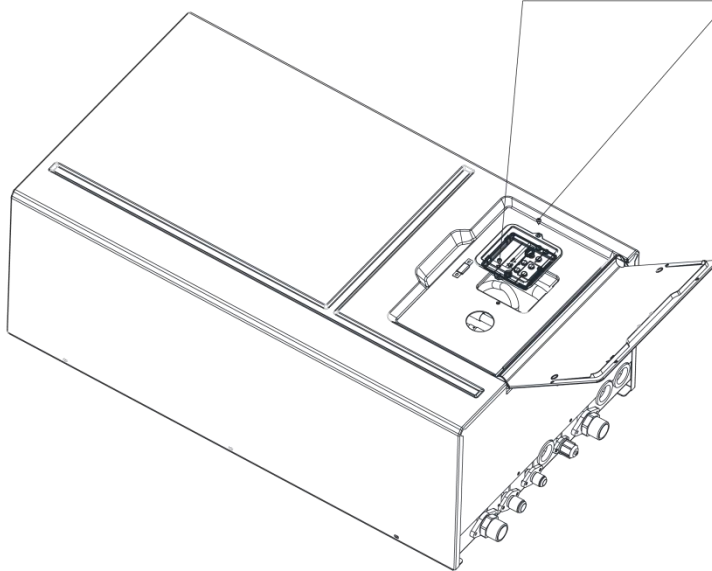

Step 2: Remove the 8 screws around the panel and then take out the panel.

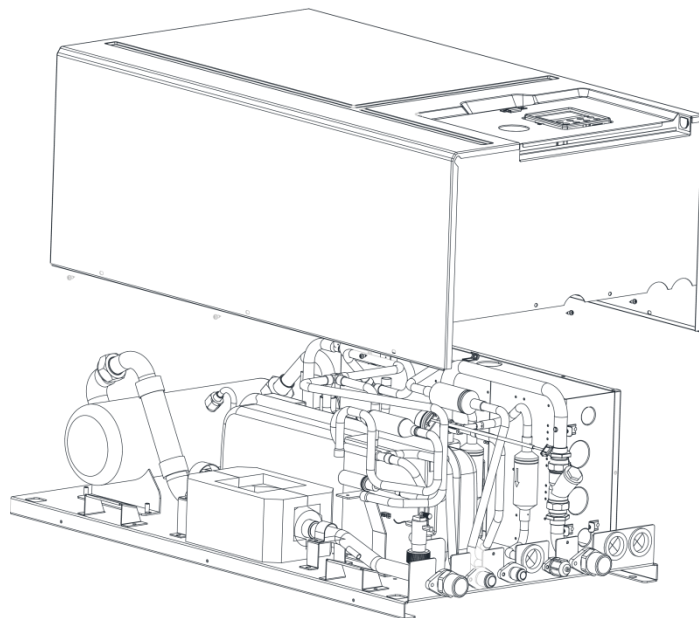

GMV5 Home DC Inverter Multi VRF Units

Step 3: Select the wall for installation; drive 4 expansion screws on the wall according to the installation location of hydro box; hang the hydro box with panel removed on the 4 expansion bolts and then tighten the nut.

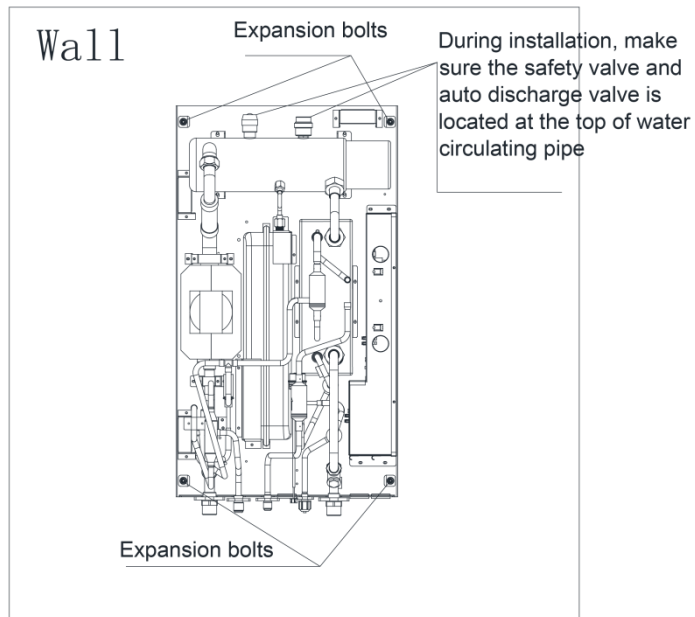

Step 4: Assemble the panel and tighten the screw; connect the connection wire of wired controller and then install the wired controller back to the panel.

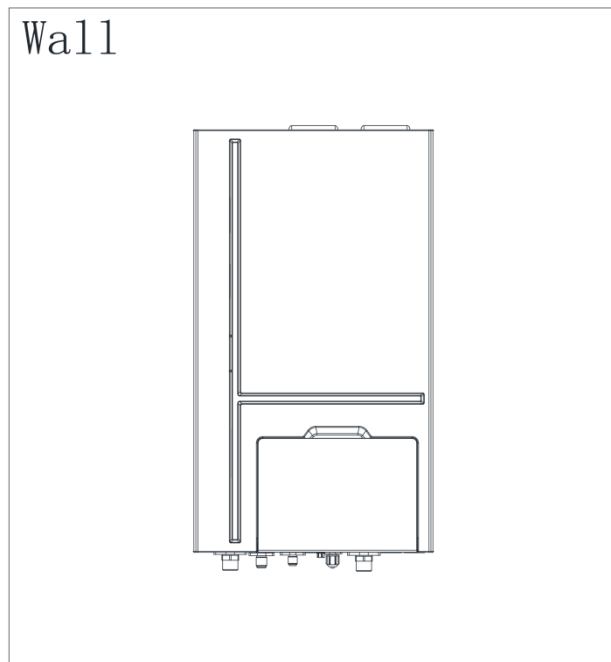

7.5 Internal Structure and Pipeline Instruction of Hydro Box

Hydro box mainly consists of water pump, plate heat exchanger, electric heater and electric control, etc. Its internal structure is shown as below:

Water pump Expansion tank Electric heat

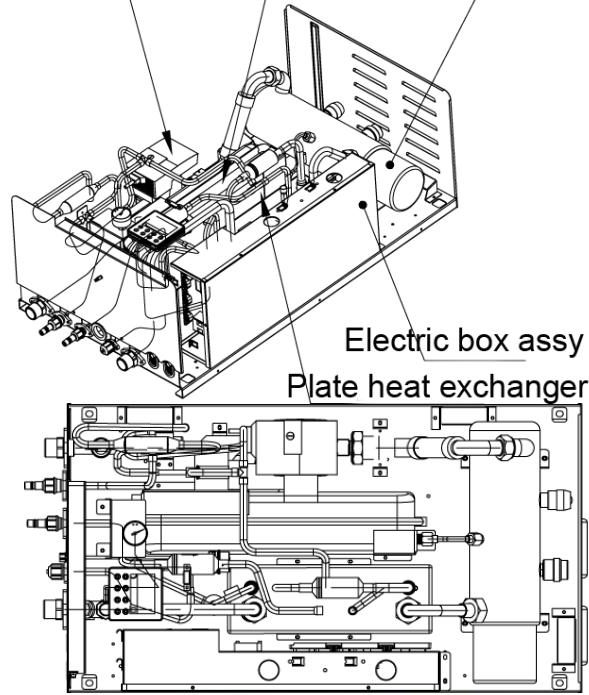

Water outlet pipe
Gas pipe
High-pressure gas pipe
Liquid pipe
Water inlet pipe



8. Installation of Water Tank

8.1 Outline Dimension and Installation Dimension of Water Tank

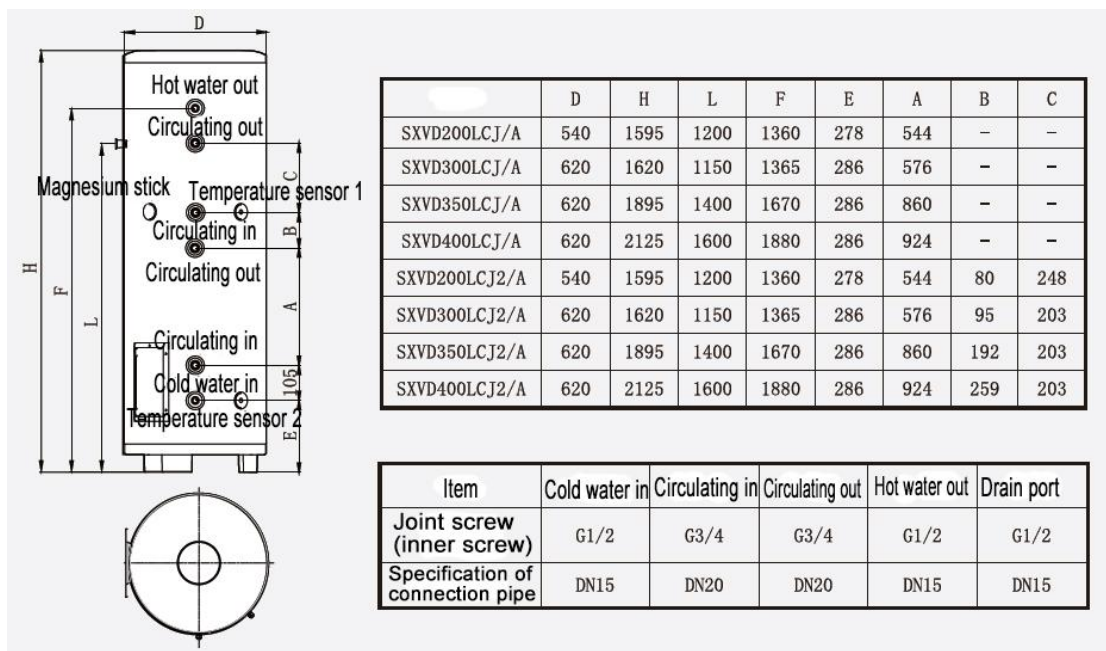

8.2 Installation Position of Water Tank

- (1) The water tank shall be installed in the place where the temp is over 0°C. It may be installed outdoors, e.g. balcony, roof or ground, according to the position of water heater. It may also be installed indoor.
- (2) The installation site shall withstand the weight of the water tank.
- (3) The drainage vent of water tank shall be close to drain ditch or sinker.
- (4) The horizontal distance and vertical distance between heat pump unit and water tank shall not exceed 5m and 3m respectively.

8.3 Installation Notice for Water Tank

- (1) The thermal insulation water tank shall be installed within a horizontal distance of 5m and a vertical fall of 3m to the hydro box. It can be installed indoors or outdoors, such as balcony, rooftop or floor.
- (2) The vertical thermal insulation water tank must be placed upright, with the bottom on ground. The installing position must be firm and solid. To avoid shaking, the water tank must be fixed onto the wall with bolts. See below for details. The weight bearing capacity of the installing position must be considered when installing the water tank.

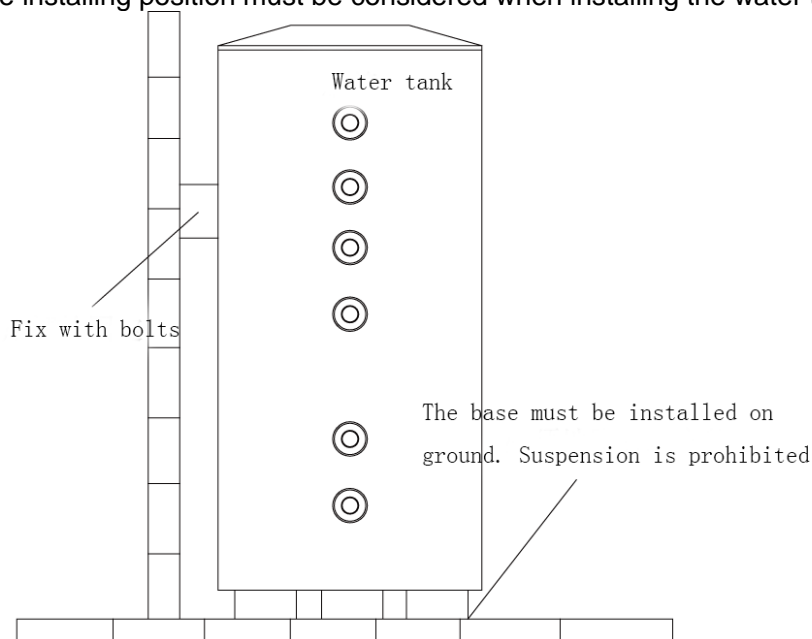

- (3) For replenishing to water tank, supply of hot water and drainage of water tank, the tap water pipe, hot water connector and ground drain shall be available close to the thermal insulation water tank.
- (4) Connection of inlet / outlet pipe: The included safety check valve (Take care that the “→” direction shall point toward the thermal insulation tank) shall be connected to the inlet of water tank by using PPR pipe and be sealed with adhesive tape, as shown below. Another end of the check valve shall be connected to the tap water. The hot water pipe shall be connected to the outlet of water tank by using PPR pipe.

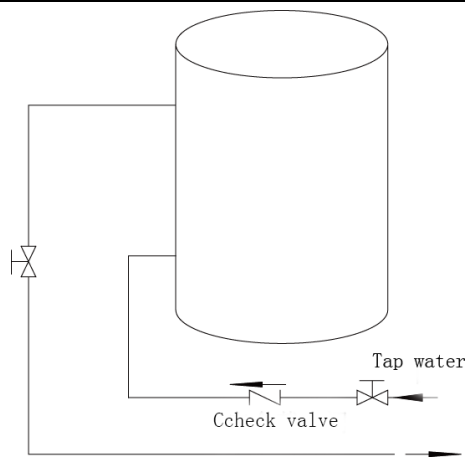

Note:

To ensure safety during use of water, the inlet and outlet of water tank must be connected with a specific length of PPR pipe. The length “L” is calculated as below: $L \geq 70 \times R^2$, in which “L” refers to pipe length (unit: cm) and R refers to the inner radius of the pipe (unit: cm). Thermal insulation shall be done and metal pipe shall not be used. For the first time of use, make sure that the water tank is filled with water before connecting to the power. The water tank shall not run without water.

9.Design, Installation and Insulation of Refrigerant Pipeline

9.1 Notices for Pipeline Design

- 1) The air conditioning installation should not damage the bearing structure or the decorative style;
- 2) Air conditioning pipes should be laid out along the bottom of the beam as possible. If pipes meet one another at the same elevation, process based on the following principles:
 - (1) Drain pipes, air ducts and pressure pipes should leave places for gravity pipes;
 - (2) Air ducts and small pipes should leave places for major pipes;
- 3) Make sure the pipes directions and branches are correct with minimum length. Use minimum number of braze welding junctions and elbows;
- 4) The refrigerant pipe cannot affect air discharge and return of indoor units.

The minimum distance between the refrigerant pipe with an insulation layer and the air return box is 300 mm. If the air return or manhole is at the right lower part of the unit, the minimum distance is 150 mm. When the refrigerant pipe needs to be laid at the air outlet side, avoid laying the pipe at the front of the air outlet. The refrigerant pipe cannot connect to any part of the unit except the joint points. If the preceding principles are not followed, performance of the unit will be affected and running noises will be increased.

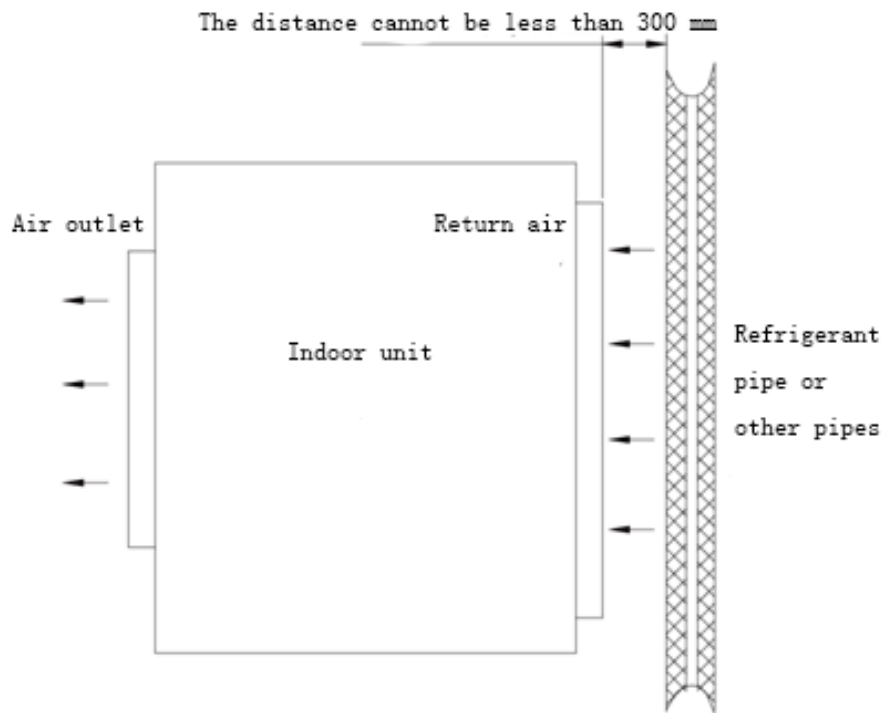

4) The refrigerant pipe must be laid away from the manhole of the unit so that sufficient space can be reserved for maintenance.

5) The riser should be installed in the air conditioning tube well, and the horizontal pipe should be placed in the ceiling, if possible.

9.2 Schematic Diagram of Refrigerant Piping

9.2.1 Piping instruction

1) Piping instruction for top discharge ODU

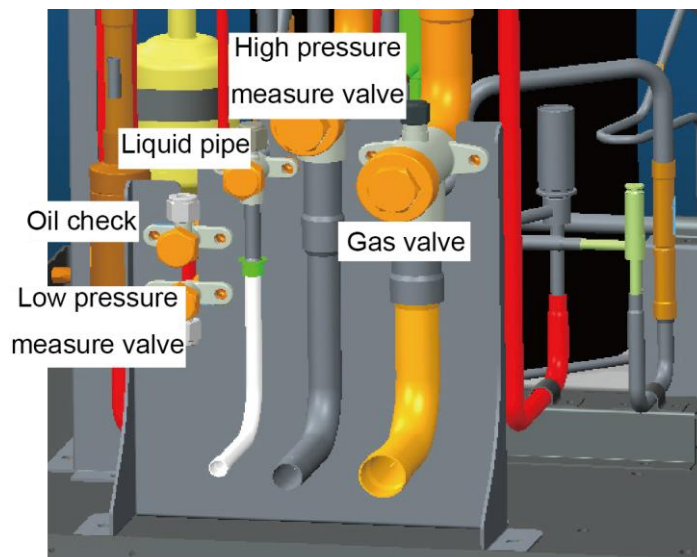

Note:

① Functions of oil check valve: During after-sale maintenance, the oil check valve can be used to extract lubricating oil samples, which are further detected to analyze the oil quality in the system. The oil check valve can also serve as the inlet for lubricating oil charging. Stop the system for at least 12 hours and wait until the system internal pressure is lower than 0.2MPa before the extracting of lubricating oil from the system; otherwise, overheat oil and overhigh pressure may

burn the operator.

② Functions of low-pressure check valve: It is mainly used for low pressure detection of the system and refrigerant charging during after-sales maintenance.

2) Piping instruction for hydro box



9.2.2 Schematic diagram for refrigerant piping of top discharge outdoor unit

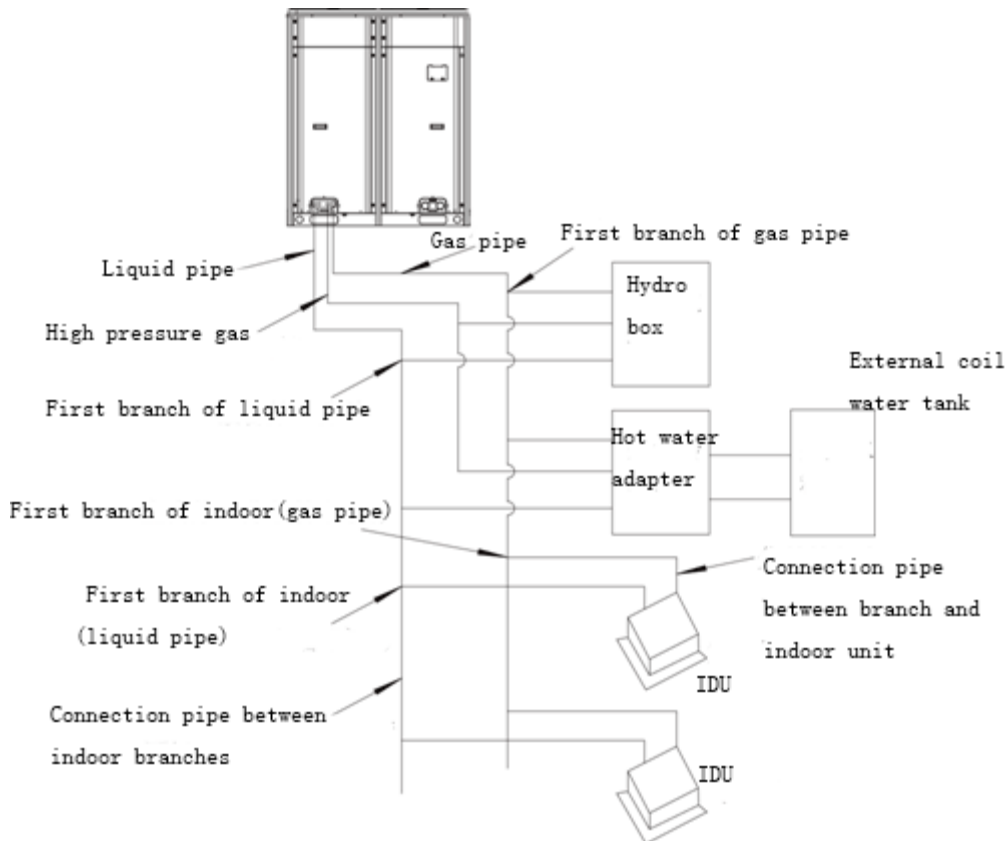

9.3 Allowable Length and Height Different of Refrigerant Piping of IDU and ODU

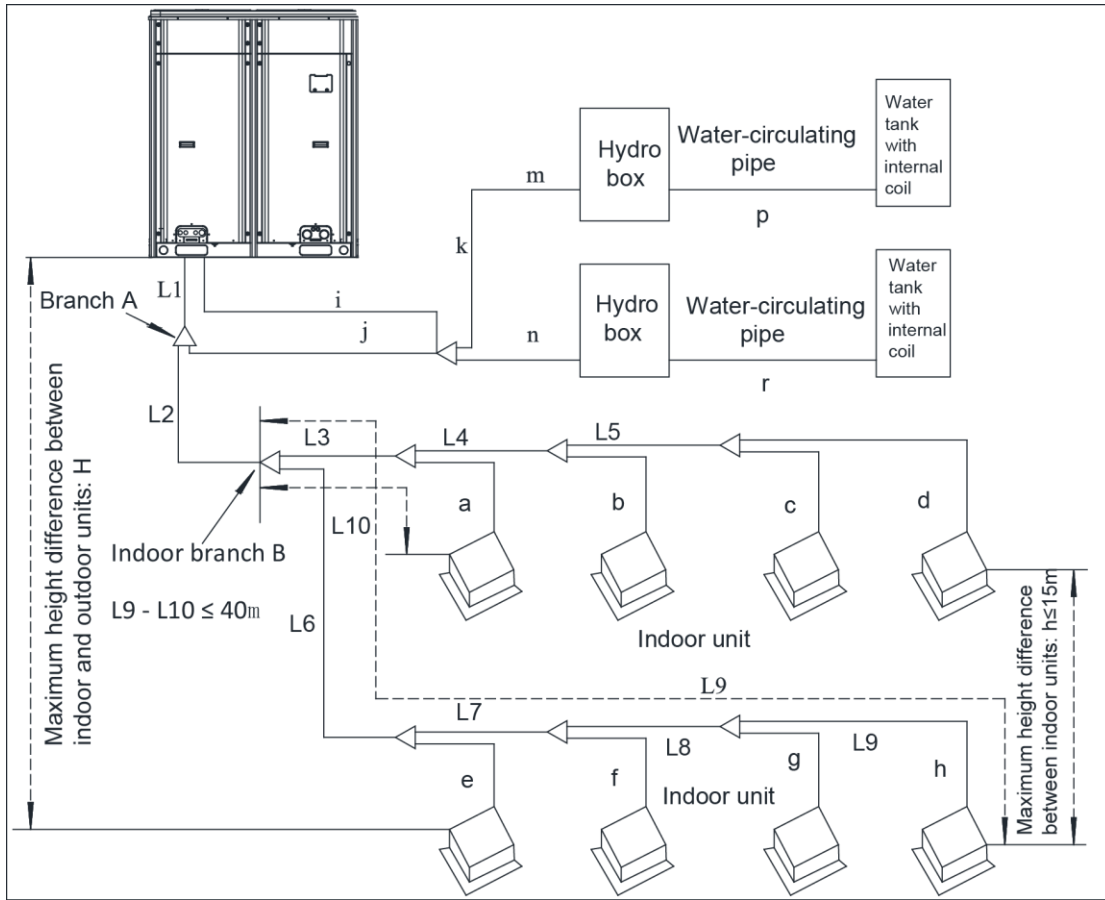

L10: Distance from the first indoor branch pipe to the farthest IDU
 L11: Distance from the first indoor branch pipe to the nearest IDU

The equivalent distance of IDU branch pipe is 0.5m

Content		Length (m)	Remark
Actual total connection pipe length		≤ 300	L1+L2+L3+L4+...+L9+a+b+...+l+m
Length from the ODU to the farthest IDU	Actual length	≤ 120	L1+L6+L7+L8+L9+h
	Equivalent length	≤ 150	
Length difference between the first indoor branch to the farthest IDU and nearest IDU		≤ 40	L10-L11
Distance from the first indoor branch pipe to the farthest IDU (1)		≤ 40	L6+L7+L8+L9+h
Height difference between IDU and ODU (H)	ODU is higher than IDU	≤ 40	—
	ODU is lower than IDU	≤ 50	—
Max height difference between ODU and hydro box		≤ 25	—
Max height difference between IDUs (including hydro box) (h)		≤ 15	—
Max length of main pipe (2)		≤ 90	L1
Length between IDU and its nearest branch pipe (3)		≤ 10	a、b、c、d、e、f、g、h
Max refrigerant pipe length between ODU and hydro box		≤ 30	i+j+k+l
Horizontal distance from hydro box to water tank with internal coil		≤ 5	P or r

⚠ Notices:

- ① Separate piping of hydro box and piping of IDU from the position of branch pipe A.
- ② Under normal condition, the pipe length from IDU branch pipe B to farthest IDU is 40m.
When the following conditions are satisfied, the pipe length can reach 90m:
 - a. Actual length of total piping: $L_1+L_2 \times 2+ L_3 \times 2+ L_4 \times 2+ \dots + L_8 \times 2+a+b+ \dots +i+j+k+m+n \leq 300m$;
 - b. Distance from each IDU to its nearest branch pipe: a, b, c, d, e, f, g, h $\leq 40m$;
 - c. Length difference between the indoor branch B to the farthest IDU and nearest IDU: $L_9-L_{10} \leq 40m$;
- ③ If the distance between IDU to its nearest branch pipe is above 10m, the diameter of IDU liquid pipe whose diameter is smaller than or equal to 6.35mm should be bigger.

9.4 Size of Refrigerant Piping

(1) The size of ping between ODU and branch pipe (main pipe) is confirmed by ODU capacity.

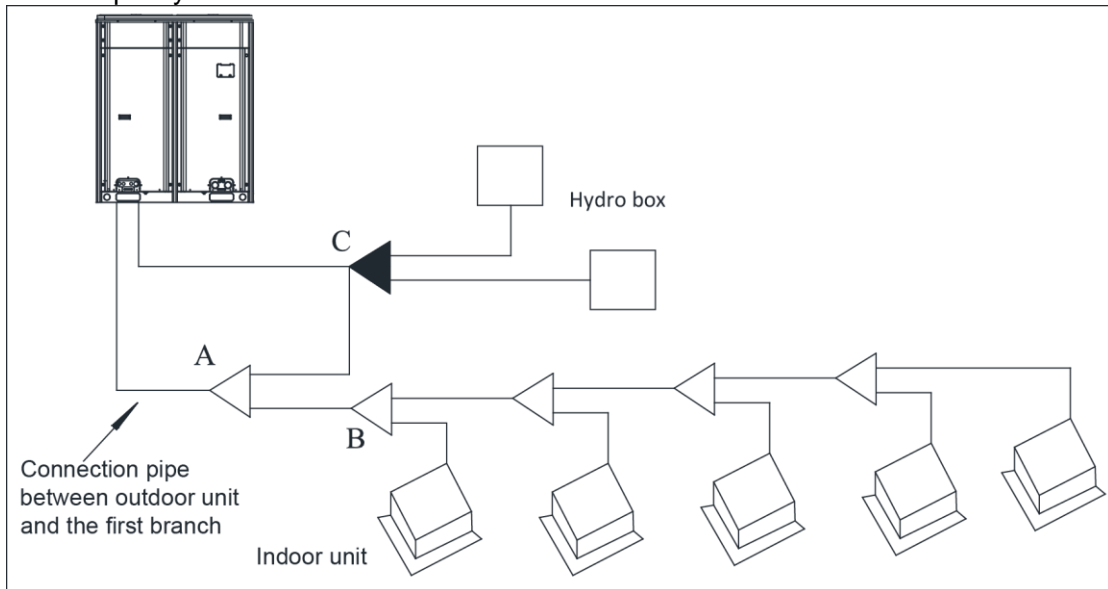

Capacity of ODU	Gas pipe	Liquid pipe	High pressure gas pipe
224	Φ19.05	Φ9.52	Φ12.7/15.9
280	Φ22. 2	Φ9.52	Φ12.7/15.9

Note: The requirements for high pressure gas pipe size please refer to the content in "Piping size between branch pipes"

(2) Slection of branch pipe

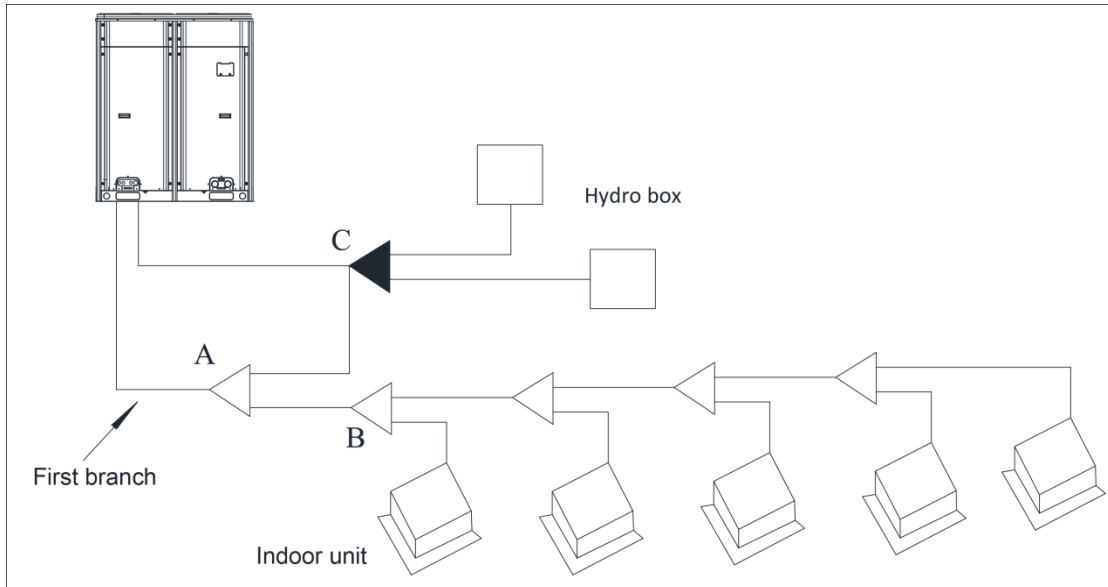

Selection of branch pipe A (the first branch pipe)

Selection of branch A (i.e. first branch)		
R410A system	Outdoor unit	Model
Y-type branch	GMV-S224W/A-X, GMV-S280W/A-X	FQ01B/A

Selection of branch pipe B (branch pipe between IDUs)

Selection of branch B (i.e. branch between indoor units)		
R410A system	Total rated capacity of downstream indoor units: X(kW)	Model
Y-type branch	$X \leq 20$	FQ01A/A
	$20 < X \leq 30$	FQ01B/A
	$30 < X \leq 70$	FQ02/A
	$70 < X \leq 135$	FQ03/A
	$135 < X$	FQ04/A

Selection of branch pipe C (connected to hydro box)

R410A system	Total number of downstream hydro box	Model
Y-type branch	X=1	Unnecessary
Y-type branch	X=2	FQ02W/A

(3) Piping size between branch pipes

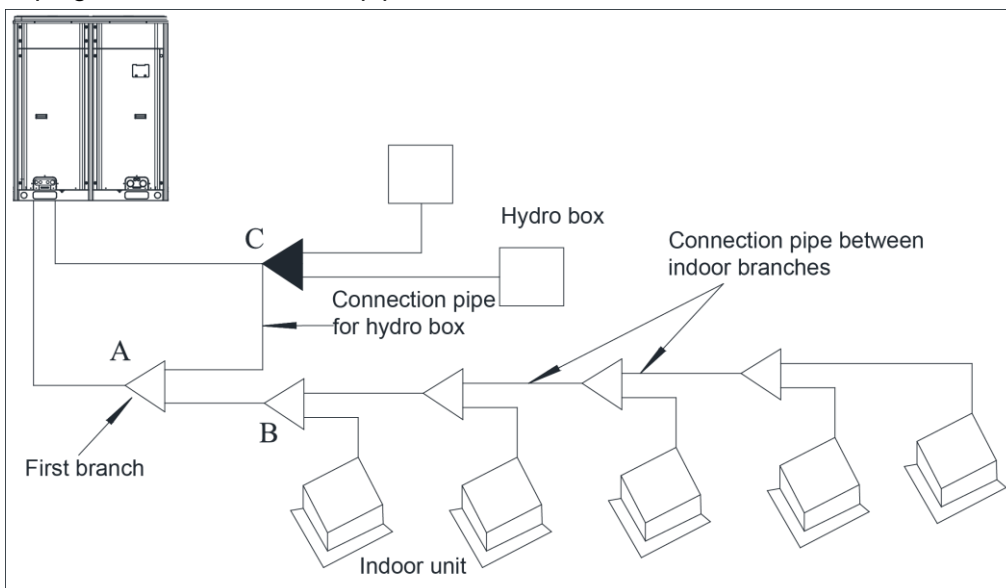

GMV5 Home DC Inverter Multi VRF Units

Piping size between branch pipe A and C, branch pipe C and ODU:

Total number of connected hydro box: X	Dimension of pipe between branch A and C, dimension of pipe between branch C and outdoor unit		
	Gas pipe	Liquid pipe	High pressure gas pipe
X=1	Φ15.9	Φ9.52	Φ12.7
X=2	Φ22.2	Φ9.52	Φ15.9

Piping size between IDU branch pipes:

Total rated capacity of downstream IDUs X (kW)	Piping size between IDU branch pipes	
	Gas pipe	Liquid pipe
X≤5.6	Φ12.7	Φ6.35
5.6<X≤14.2	Φ15.9	Φ9.52
14.2<X≤22.0	Φ19.05	Φ9.52
22.0<X≤30.0	Φ22.2	Φ9.52
30.0<X≤45.0	Φ28.6	Φ12.7
45.0<X≤67.0	Φ28.6	Φ15.9
67.0<X≤95.0	Φ34.9	Φ15.9
95.0<X≤135.0	Φ41.3	Φ19.05
135.0<X	Φ44.5	Φ22.2

(4) The piping dimension between the branch to its connected terminal is the same as the piping dimension of terminal (if the distance from the first branch to a certain IDU exceeds 30m, the diameter of piping at gas side from the first branch to this IDU should be bigger).

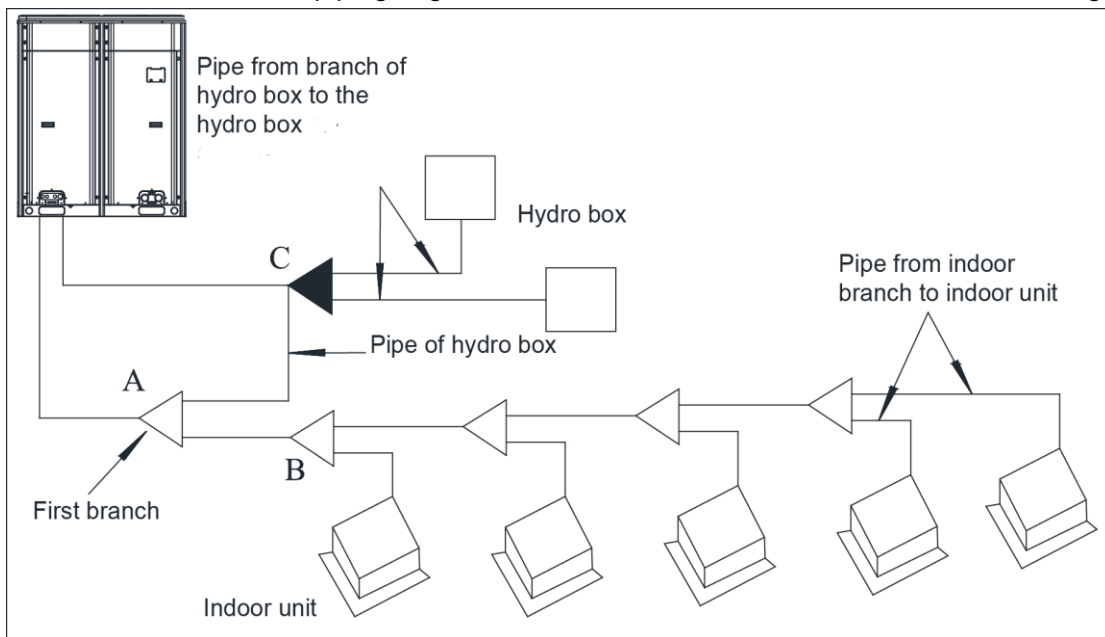

Piping size of IDU

IDU capacity X (kW)	Piping size between IDU branch to IDU	
	Gas pipe	Liquid pipe
X≤2.8	Φ9.52	Φ6.35
2.8<X≤5.0	Φ12.7	Φ6.35
5.0<X≤14.0	Φ15.9	Φ9.52
14.0<X≤16.0	Φ19.05	Φ9.52
16.0<X≤28.0	Φ22.2	Φ9.52

Piping size of hydro box

Terminal	Piping size between hydro box/adaptor and its branch pipe		
	Gas pipe	Liquid pipe	High pressure gas pipe
Hydro box	Φ15.9	Φ9.52	Φ12.7

9.5 Installation and Insulation of Refrigerant Pipe

9.5.1 Pipe installation for cooling system

9.5.1.1 Processing to refrigerant pipes

9.5.1.1.1 Cut-off and burring



Warning! Use a special-purpose pipe cutter to cut copper pipes instead of using a hacksaw.

- 1) Use a special-purpose pipe cutter to cut copper pipes;
- 2) Cut the pipes gently to ensure that the copper pipe does not deform;
- 3) After cutting the pipes, use a slicker to grater bur the pipes with the pipe opening inclining downward so that the copper scales do not fall into the pipe;
- 4) If the copper pipe is not used immediately after cut-off, cover it with a sealing cap or adhesive tape;
- 5) Allowable deviation: Skewness of the cross section cannot exceed 1% of the copper pipe caliber.

9.5.1.1.2 Pipe cleaning

- 1) Cleaning with a piece of silk cloth-applicable to straight pipes
 - (1) Wrap a thin steel wire with a piece of clean silk cloth. Crumple the cloth into a lump with diameter larger than the pipe caliber;
 - (2) Apply several drops of chlorylene to the cloth. Push the cloth in from one end of the pipe and pull out from the other end;
 - (3) Every time the cloth is pulled out, remove the dust and sundries with chlorylene;
 - (4) Wash repeatedly until the pipe is clean.
- 2) Cleaning with nitrogen-applicable to coils
Blow off all dust and sundries in the pipe with nitrogen.



Warning! After cleaning, cover the both ends of the pipe with a sealing cap or adhesive tape.

9.4.1.1.3 Pipe bending



Notices

During bending, there must be no corrugation or deformation inside the pipe.
The welding point of the pipe should not be at the bending part. The distance between the nozzle welding joint and the bending part should not be less than 100 mm.

- 1) Processing requirements:
The radius of the bending pipe must exceed 3.5D. The ratio of the short diameter after bending to the original diameter must exceed 2/3.
- 2) Processing methods:
 - (1) Manual bending: applies to thin copper pipes ($\Phi 6.35$ mm to $\Phi 12.7$ mm)
 - (2) Mechanical bending: applicable range ($\Phi 6.35$ mm to $\Phi 54.1$ mm)

9.4.1.1.4 Pipe expanding

Pipe expanding is used to provide a welding point for pipe connection. Requirements on pipe expanding are as follows:

- 1) Before pipe expanding, apply appropriate amount of lubricant on the surface of the pipe. (The lubricant must meet the refrigerant system's requirements);
- 2) Pipe expanding length must be in accordance with the insertion depth of the caliber;
- 3) To avoid leakage due to straight lines at the expanding point, turn round the copper pipe and then make corrections;
- 4) Apply appropriate force during pipe expanding to avoid crack.

9.4.1.1.5 Flaring

Another mode of pipe connection is flare opening connection, which requires pipe flaring before connection.

- 1) Put the flaring nuts into the copper pipe;
- 2) Put the pipe into the root of the pipe expander and the arrange flaring;

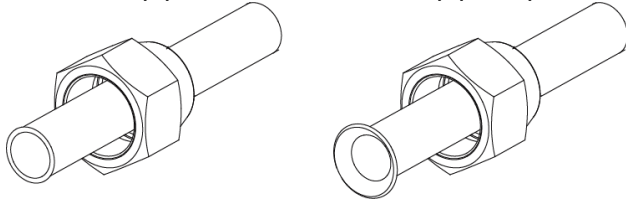

- (1) Before pipe flaring, apply appropriate amount of lubricant on the surface of the opening to ensure smooth pass of flaring nuts and avoid pipe distortion;
- (2) The concentricity must be ensured after pipe flaring. The sealing face must be intact without any burr, crack, or wrinkle;
- (3) Use a slicker to remove the little burs in the pipe port.

9.5.1.2 Installation of refrigerant pipes

9.5.1.2.1 Operation sequence

The sequence for installing the refrigerant pipe is as follows:

Preparing and installing the support, hanger, and bracket – Piping according to the drawing – Cleaning the pipe – Processing the pipe – Adding an insulation sleeve – Connecting the pipe – Fixing the pipe – Blowing contaminants in the pipe system – Performing a air-tightness test – Performing insulation.

9.5.1.2.2 Construction of support, hanger, and bracket

- 1) Construction of supports, hangers, and brackets for pipes: These parts must be fixed securely in reasonable type and style without any tilt. The surface is clean without any dirt. The parts embedded into the wall or floor cannot be painted or coated and must be free from grease stains;
- 2) Construction of fixing bolts for devices: Ensure sufficient rigidity for the devices. Take anticorrosive measures for exposed part of built-in fittings. If the foundation must be waterproof, takes waterproof measures;
- 3) Construction of steel casings: Equip a steel casing for all pipes which are led through the wall or floor. Pipe welding joints cannot be placed inside the sleeve. The steel casing must be parallel with the bottom of the wall or floor but be 20 mm or more above the bottom. The diameter of the steel casing must be determined based on the thickness of the insulation layer and the inclination degree of the condensate water pipe. Fill the gap between the pipe and the sleeve with flexible and non-flammable materials. The sleeve cannot be used as a support point of the pipe.
- 4) Operation sequence



If possible, make ink lines on the ground and project them to the top of the building.

5) Installing built-in metal fittings

Select built-in metal fittings in accordance with local regulations.

6) Installing expansion bolts

Use expansion bolts when built-in metal fittings are unavailable due to design change.

7) Installing expansion bolts

●If the foot pedal is 2m or more from the ground, there must be three points of support.

The foot pedal must be tightened securely with the ladder.

●Do not perform operations on the top of the ladder.

9.5.1.2.3 Shaping and fixing of pipes

When installing refrigerant pipes, ensure that the directions and branches are correct with minimum length. Use minimum number of braze welding junctions and elbows. Alignment and

insulation after installation cannot affect the pipe location and elevation. There shall not be flat bending or corrugation on the pipe after piping.

Use angle steel support, bracket, round steel hanger, U-type pipe clip, or flat steel to fix pipes outside the insulation layer. It is better that the insulation materials be not compressed to ensure good insulation.

The style and workmanship of supports, hangers, and brackets must follow the standard T616 HVAC Systems Design Handbook.

The minimum distance between supports, hangers, and brackets is listed in the table below:

External Diameter of the Pipe (mm)	$\phi \leq 16$	$16 < \phi < 19.05$	$\phi \geq 19.05$
Distance between Horizontal Pipes (mm)	1000	1500	2000
Distance between Vertical Pipes (mm)	1500	2000	2500

The pipe led through a wall or beam must be fixed by a support, hanger, or bracket on both ends at the position 300 mm away from the hole.

9.5.1.2.4 Pipe connection

1) Flaring connection:

The refrigerant pipes and IDUs are connected by using the flare opening. Therefore, the quality of flaring connection must be ensured. The flaring depth of the bell mouth cannot be smaller than the caliber. The flaring direction must face towards the direction of medium flow. Use two torque wrenches to fasten the connection.

2) Socket welding:

The gap between socket components should be proper to ensure that the connection will not loose from the friction surface. The flaring direction of the socket component must face towards the direction of medium flow. During pipe connect, protect the braze welding part according the length specified below:

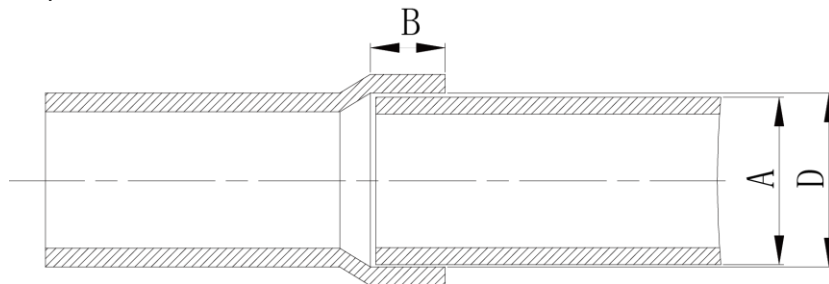

A: External Diameter of the Pipe (mm)	B: Minimum Insertion Depth (mm)	D-A: Gap between Pipes (mm)
$\phi 6.35$	6	0.05~0.21
$\phi 9.52$ $\phi 12.7$	7	
$\phi 15.8$	8	0.05~0.27
$\phi 19.05$ $\phi 22.2$ $\phi 25.4$	10	
$\phi 28.6$, $\phi 31.8$	12	
$\phi 38.1$ $\phi 44.5$	19	0.15~0.35
$\phi 54.1$	24	0.15~0.35

3) Bell socket welding

The bell socket welding is another form of socket welding. It uses the sleeve or pipe in a larger size for welding. The insertion depth cannot be smaller than that required by socket welding.

4) Flange connection

The pipes with large caliber and the devices are always connected by using a flange, which must be clean and intact. Before installation, apply lubricant on the surface of the flange. Two flanges must be symmetrical. Fasten with screws at the diagonal direction to avoid inclination.

9.5.1.2.5 Welding protection

Aerate with nitrogen before and during welding and keep aerating for 30 s after the welding is

finished.

Equip a pressure regulator valve to the nitrogen cylinder.

The nitrogen flow is above 4-6 L/min (pressure of 0.02 to 0.05Mpa) and must be regulated based on the pipe caliber.

9.5.1.2.6 Requirements on manifold installation

Manifolds are used to divert refrigerant. Requirements on manifold installation are as follows:

1) Ensure that the manifold is close to the IDU to reduce impact on refrigerant assignment by IDU branches;

2) The manifold must be that specified by the manufacture and match with the devices;

3) Ensure that the manifold model is correct;

4) Manifolds can be laid in the following ways:

(1) Horizontal installation: The three ports must be on the same level. The shaping size and assembly angle cannot be changed;

(2) Vertical installation: The direction can be upwards or downwards. Three ports must be on the same elevation without inclination;

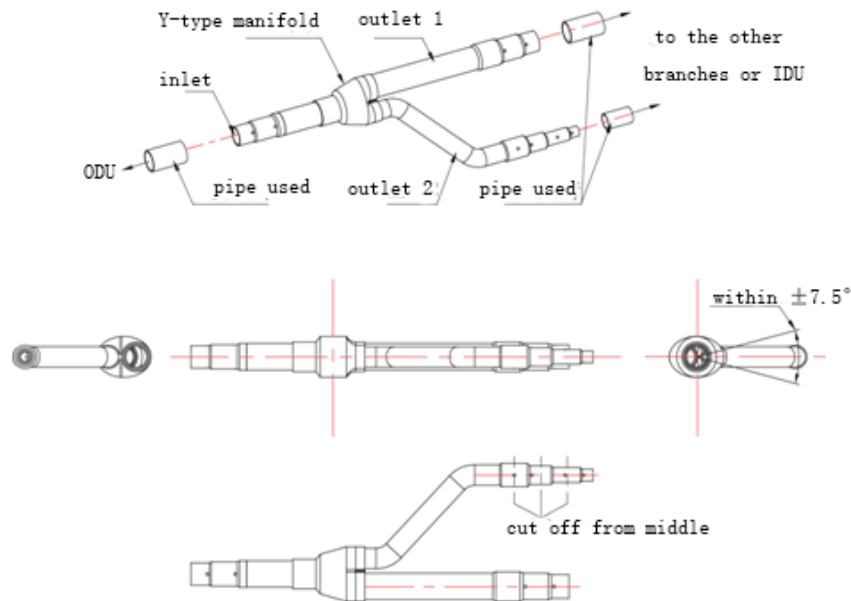

(3) The length of a straight pipe between two manifolds cannot be less than 500 mm;

(4) The length of a straight pipe before the main pipe port of the manifold cannot be less than 500 mm;

(5) The length of a straight pipe between the branch of the manifold and the IDU cannot be less than 500 mm;

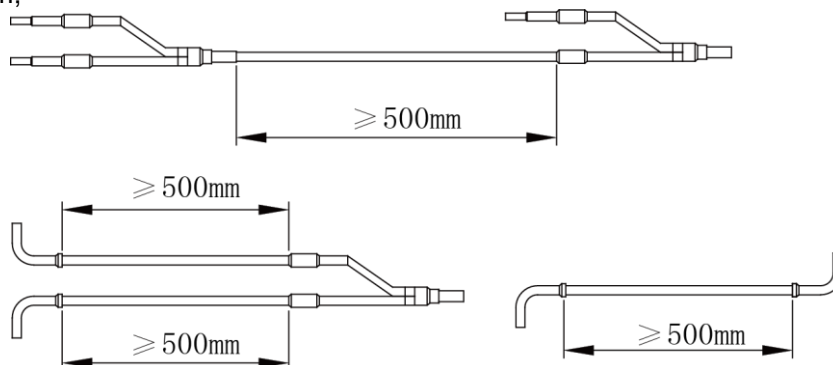

5) Fixing of manifolds

There must be three fixing point for both horizontal and vertical installation of the Y-type manifold:

Fixing point 1: 100 mm on the main inlet manifold from the welding point;

Fixing point 2: 200 mm on the main branched pipe from the welding point;

Fixing point 3: 250 mm on the branched pipe from the welding point.

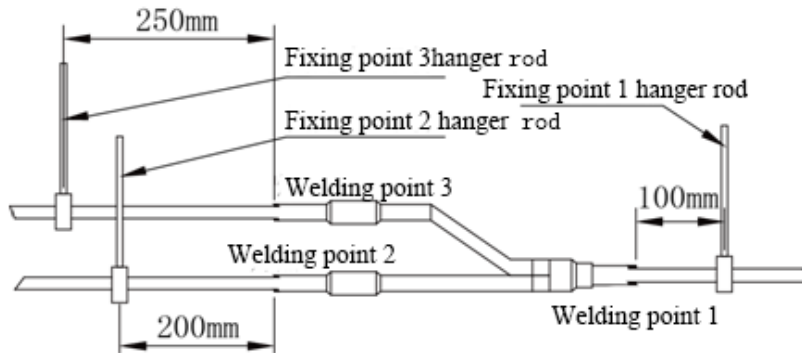

Branches of a manifold must be laid parallel and cannot be wrapped in superimposed mode.

6) The liquid pipe and gas pipe must have the same length and be laid in the same route;

7) The Y-type manifold has an attached pipe used to adjust the diameter of different pipes. If the pipe size on site does not match the size of the manifold junction, use the pipe cutter to cut at the middle of the pipe and remove burrs. Then insert the copper pipe to proper depth. A concave bag for positioning is available to the manifold purchased from Gree.

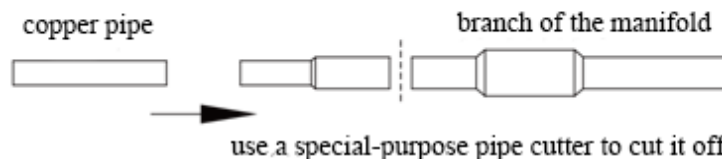
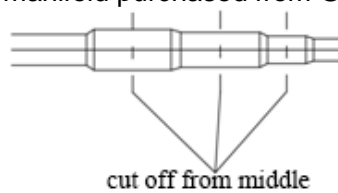

8) Because the manifold structure is complex, perform with care to ensure tight insulation.

9.4.1.2.7 Pipe cleaning by nitrogen

Before connecting the flare opening of the pipe to the IDU, connect the pressure regulator valve on the nitrogen cylinder to the liquid pipe in the outdoor pipe system. Regulate the nitrogen pressure to about 5kgf/cm² and blow nitrogen into the pipe for 1minute. Repeat this operation for three times till the dirt and water are discharged. After cleaning the liquid pipe, perform the same operation to clean the gas pipe.

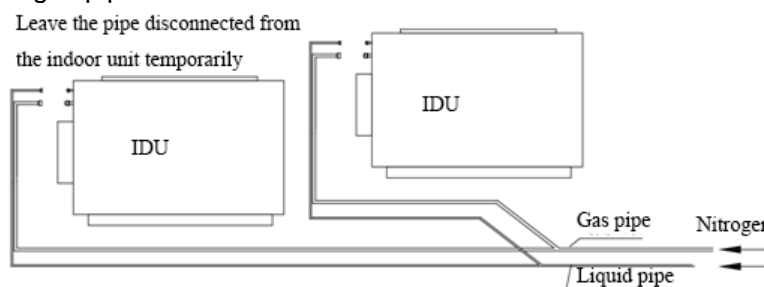

Perform an air-tightness test and a vacuum test to the entire refrigerant pipe system after the construction is finished.

There must be a secure distance between pipes. Pipes in different types must be fixed separately.

9.5.1.2.8 During refrigerant pipe installation, ensure a distance above 500 mm between the pipe and the electric box of the unit for maintenance. In a case when the space is not enough, the final piping way must be determined by the technical personnel.

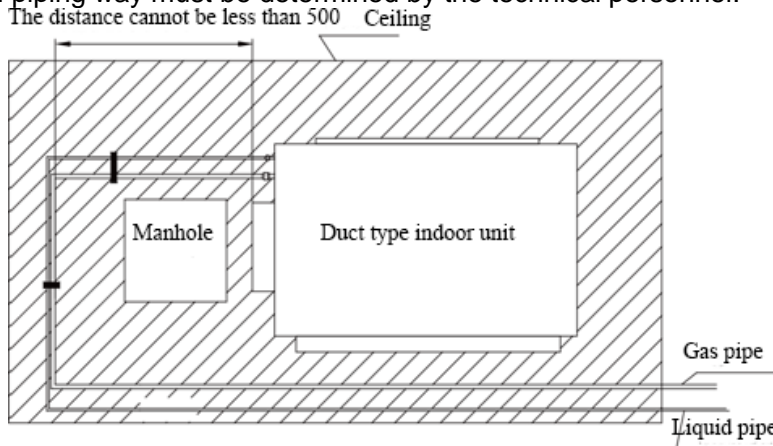

9.4.1.2.9

As the piping for the VRF system is complex, it is recommended that a filter is installed for the gas pipe and a drier is installed for the liquid pipe during construction. This ensures aridity and cleanliness of the piping system and further improves the operation stability of the system.

The procedure is as follows:

First, weld a stop valve with the corresponding caliber to the gas pipe and liquid pipe at the position relatively close to the ODU and easy for operation.

Second, install a filter (100 mesh/ft²) between the added stop valve outside the gas pipe and the stop valve of the ODU. Then install a drier filter between the added stop valve outside the liquid pipe and the stop valve of the ODU.

Lastly, after the test run is complete,

To remove the filter from the gas pipe after starting all IDUs and keeping them running cooling mode for 24 hours: power off all units; turn off the two stop valves of the gas pipe; remove the filter; short connect with a copper pipe with the same caliber and vacuumize the pipe; open the two stop valves and keep normal running.

To remove the drier filter from the liquid pipe after starting all IDUs and keeping them running in heating mode for 24 hours: power off all units; turn off the two stop valves of the liquid pipe; remove the filter; short connect with a copper pipe with the same caliber and vacuumize the pipe; open the two stop valves and keep normal running.

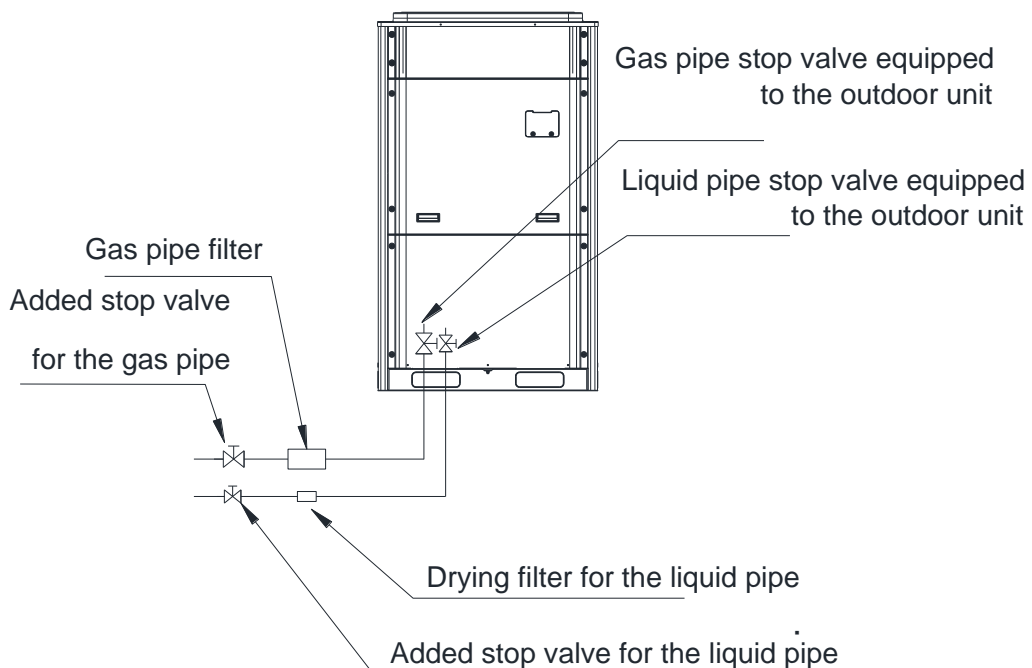

9.5.1.3 Air-tightness test

**Precautions:**

The measuring range of the test pressure gauge for R410A system must be above 4.5MPa. Record the value displayed on the pressure gauge, ambient temperature, and test time.

Pressure correction: The pressure changes by 0.01MPa when the temperature changes by 1°C.

The pressure meets the requirement if it does not change.

If the pressure must be kept for a long time, decrease the pressure to 0.5MPa or lower. High pressure for a long time may cause leakage at the welding point or safety hazard.

Before performing the air-tightness test to the refrigerant pipes, do not conduct insulation or wrapping at the welding or flaring opening joints of the IDU. The pressure must be increased simultaneously for pipes on outdoor sides and cannot be increased for pipes on one side.

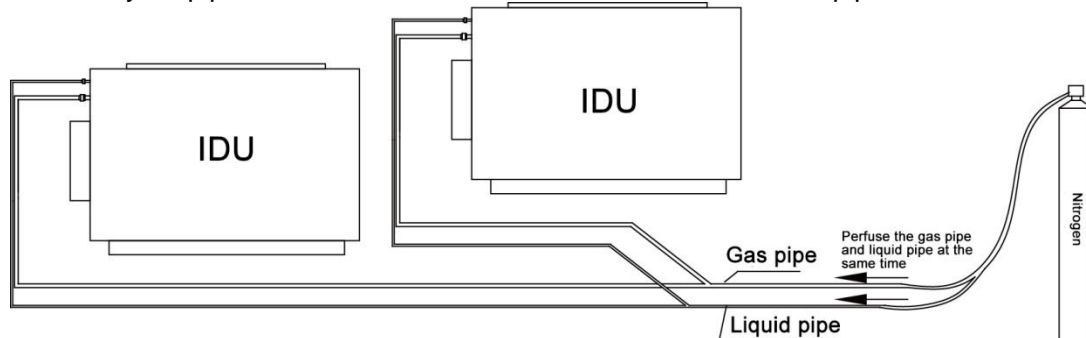

Note: Before performing the air-tightness test, do not conduct insulation or wrapping at the welding joints.

9.5.1.3.1 Importance of the air-tightness test

Air-tightness of the multi-module air conditioning system mainly refers to the tightness of the refrigerant pipes, which ensures secure and reliable running of the air conditioner.

Refrigerant leakage may affect functions of the air conditions or even damage the compressor and make the system to break down. Therefore, a air-tightness test must be performed. If refrigerant leakage is detected after the system is installed, it is very difficult to locate the leaking point as the suspending ceiling has been decorated. Therefore, the air-tightness test must be performed before ceiling sealing for indoor decoration is finished.

9.5.1.3.2 Procedure for performing the air-tightness test

Stop valves of the gas and liquid pipes of the ODU are turned off at delivery.

Before test, apply a small amount of required lubricant on the block nut and pipe terminals and use two wrenches to fix the block nut.

The ODU pipes cannot be connected when the air-tightness test is being performed.

The test pressure for R410A system is 4.15MPa. Use dry nitrogen as media for the air-tightness test. Increase the pressure slowly by following the steps below:

Step 1: Increase the pressure to 0.5MPa. Stop for 5 minutes and then perform air-tightness check. Major leakage may be detected.

Step 2: Increase the pressure to 1.5MPa. Stop for 5 minutes and then perform air-tightness check. Minor leakage may be detected;

Step 3: Increase the pressure for R410A system to 4.15MPa. Stop for 5 minutes and then perform strength check. Slight leakage or blow holes may be detected. After increasing the pressure to the test pressure, keep the pressure for 24 hours and check whether it decreases. If the pressure does not decrease, it meets the requirement.

9.5.1.4 Vacuumization and desiccation for the system

9.5.1.4.1 Requirements on the vacuum pump

- 1) The vacuum pump for different refrigerant systems cannot be the same.
- 2) The ultimate vacuum degree of the vacuum pump should reach -0.1Mpa.
- 3) The air discharge capacity of the vacuum pump must be greater than 4L/S.
- 4) The precision of the vacuum pump must be greater than 0.02mmHg.
- 5) The system vacuum pump must be equipped with a check valve.

9.5.1.4.2 Procedure and precautions for vacuumization and desiccation

- 1) Before vacuumization, ensure that the stop valves of the gas pipe, liquid pipes and high-pressure gas pipe are turned off.

2) Use the perfusing duct to connect the regulator valve and vacuum pump to detection connectors of the gas pipe valve, liquid pipe valve and high-pressure gas pipe valve.

3) Vacuumize for 4 hours and check whether the vacuum degree reaches -0.1MPa or more. If not, leakage may exist. Perform leakage check again. If no leakage exists, continue to vacuumize for 2 hours.

4) If the vacuum degree cannot be kept after vacuumization is performed for twice, there may be water in the pipe when it is confirmed that no leakage exists. In this case, discharge water by means of vacuum breaking. Perfuse nitrogen at 0.05MPa to the pipe. Vacuumize for 2 hours and keep vacuuming for 1 hour. If the vacuum degree of -0.1MPa cannot be reached, repeat this operation till water is discharged.

5) After vacuumization, turn off the regulator valve and keep for 1 hour. Ensure that the pressure of the regulator valve does not increase.

9.5.1.4.2 Precautions:

1) Arrange vacuumization from the gas pipe and liquid pipe simultaneously and then arrange vacuumization from the high-pressure gas pipe.

Check if the gas pipe valve, liquid pipe valve and high pressure gas pipe valves of ODU connected with IDU and hydro box are fully closed.

As shown below, discharge air with vacuum pump from the gas pipe valve, liquid pipe valve and high pressure gas pipe valves of ODU. If all IDUs and ODU are energized, the unit can enter vacuum pumping mode of IDUs, ensuring that the valves of IDU and hydro box are open.

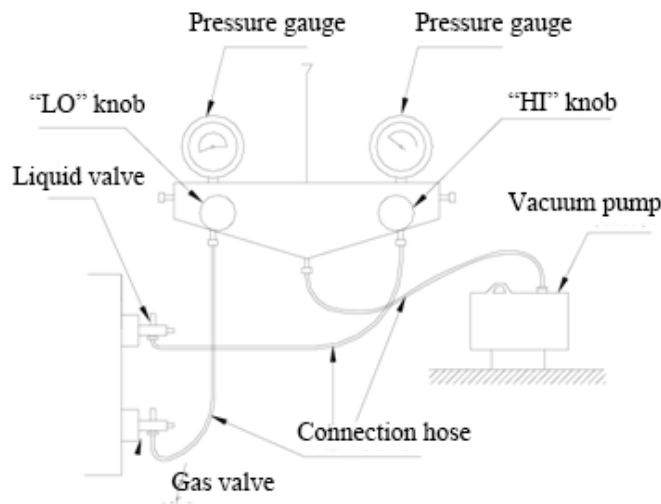

2) Turn off the valve before powering off the vacuum pump.

3) Keep vacuuming for 2 hours. The vacuum meets the requirement if the pressure displayed by the vacuum gauge does not increase.

9.5.2 Insulation for the refrigerant system pipe

9.5.2.1 Insulation materials

Use closed-cell foam insulation materials with flame retardant grade of B1.

The heat conductivity is not greater than 0.035 w/(m·k) when the average temperature is 0°C.

9.5.2.2 Thickness of the insulation layer

External Diameter of the Pipe (mm)	≤12.7	≥15.88
Thickness of the Insulation Layer (mm)	≥15	≥20

Use sunblock, anti-weathering, and non-cracking insulation materials for outdoor pipes.

9.5.2.3 Procedure of insulation

1) Select insulation materials based on design requirements.

- 2) Wear the insulation sleeve before connecting refrigerant pipes. Users cannot cut the insulation material apart and then wrap up with ties after connecting the pipes by welding.
- 3) Specifications of the insulation sleeve must match with that of the refrigerant pipes.
- 4) Reserve a distance of about 200mm near the welding point to protect the insulation sleeve during welding. After performing the air-tightness test, perform insulation to the welding point separately to ensure continuity of the insulation sleeve.
- 5) The insulation layer cannot crack during construction. Bond the insulation material joints with special glue and then wrap them with electrical adhesive tape. The width of the adhesive tape must be 50mm or more to ensure secure connection.
- 6) Use glue to bond the insulation material at the water outlet to the unit to prevent dewing.
- 7) Wrap joints of indoor/outdoor units with insulation materials. There must be no gap between the joint and the wall of the indoor/outdoor unit, as shown in the following figure.

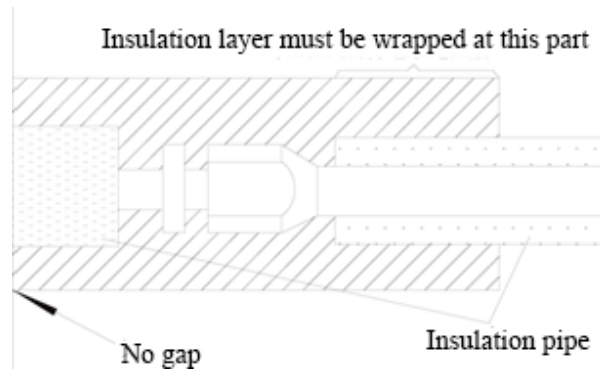

10. Pipe Installation and Insulation for the Condensate Water System and Insulation for the Ducts

10.1 Pipe Installation and Insulation for the Condensate Water System

10.1.1 Pipes

Generally, U-PVC water supply pipes bonded with special glue are adopted as condensate water pipes. PP-R, PP-C, and hot galvanized steel pipes can also be adopted. Aluminium plastic compound pipes cannot be used.

10.1.2 Requirements on installation

1) Determine the direction and elevation of a condensate water pipe before installing it. Avoid overlapping it with other pipes to ensure straight inclination. The clamp of the pipe hanger is fixed outside the insulation layer. The height of the clamp can be adjusted.

2) Distance between hangers:

External Diameter of the Pipe (mm)	$\Phi \leq 25$	$32 > \Phi \geq 25$	$\Phi \geq 32$
Distance between Horizontal Pipes (mm)	800	1000	1500
Distance between Vertical Pipes (mm)	1500		2000

There are at least two hangers for each vertical pipe.

3) The inclination degree of the condensate water pipe must be above 1% and that of the main pipe cannot be lower than 0.3%. Adverse slopes are not allowed.

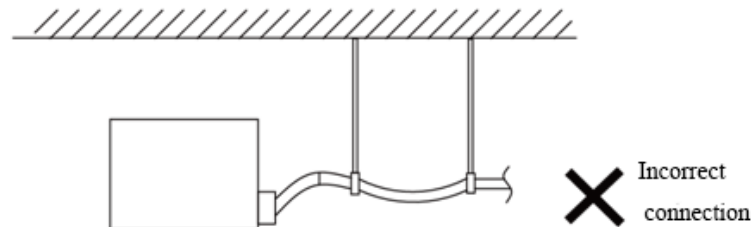
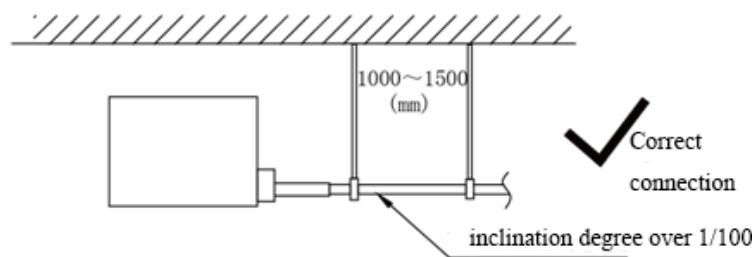

4) When connecting three-way pipes, the two-way straight pipes must be laid on the same slope, as shown in the following figures.

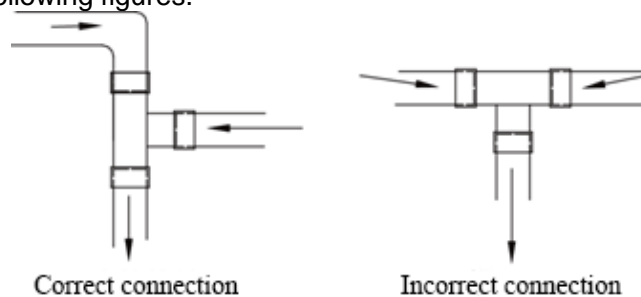

- 5) The condensate water pipe cannot be tied with the refrigerant pipe.
- 6) A ventilation hole must be provided on the top of the drain pipe to ensure smoother discharge of condensate water.
- 7) After pipes are connected, perform a test with some water and another test with full water in the pipe to check whether drainage is smooth and whether water leakage exists in the pipe system.
- 8) Equip a steel casing for all pipes which are led through the wall or floor. Pipe bonding joints cannot be placed inside the sleeve. The steel casing must be parallel with the bottom of the floor or wall. There must be a height drop of 20 mm from the ground when the pipe is led through the floor. The sleeve cannot affect the inclination degree of the pipe. Fill the gap between the pipe and the sleeve with flexible and non-flammable materials. The sleeve cannot be used as a support point of the pipe.
- 9) Bond the insulation material joints with special glue and then wrap them with plastic adhesive tape. The width of the adhesive tape must be 5cm or more to prevent dewing.
- 10) When connecting the drain pipe to that of the IDU, fix the pipes with the bands provided upon delivery instead of using the glue to facilitate further maintenance.
- 11) When connecting the drain pipe branches to the main pipe, lead through from the above part of the main pipe.
- 12) If the air volume of the IDUs is high and outdoor air resorption may be caused by negative suction pressure, provide a u-type drain trap at the water outlet side of each IDU, as shown in the following figure.

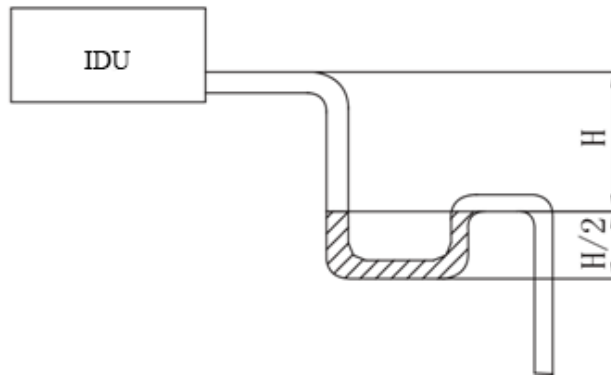

Install drain trap connectors as shown in the following figure;
 Install a drain trap connector for each unit;
 The drain trap connector shall be installed in a way that facilitates trap cleaning.

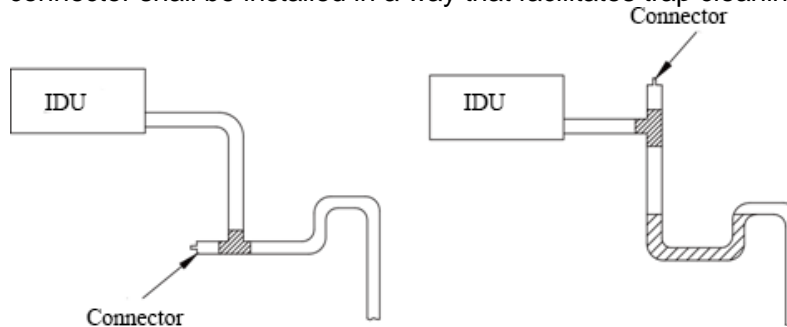

13) During condensate water pipe installation, ensure a distance above 500 mm between the pipe and the electric box of the unit for maintenance. In a case when the space is not enough, the final piping way must be determined by the technical personnel.

10.1.3 Requirements on installation of drain pipes for different types of IDUs

10.1.3.1 Drain pipe installation for hidden duct type IDU

- 1) Ensure an inclination degree of greater than 1% when connecting the drain pipe to the IDU.
- 2) When connecting the drain pipe to that of the IDU, fix the pipes with the bands instead of using the glue to facilitate further maintenance.
- 3) There is a condensate water outlet on both sides of the IDU. After one condensate water outlet is determined, use the rubber stopper to block the other outlet. Tie it with threads and strap with insulation materials to prevent leakage.
- 4) The connection between the drain pipe and that of the IDU is shown in the following figure:

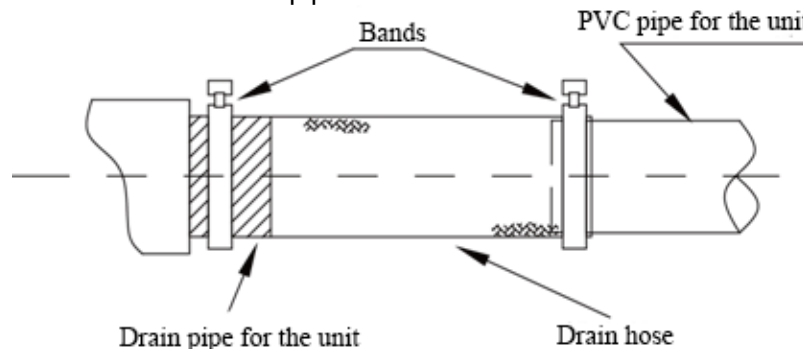

5) Apply insulation materials to the condensate water pipe joints to prevent dewing. Insulation for connection between the drain pipe and that of the IDU is shown in the following figure:

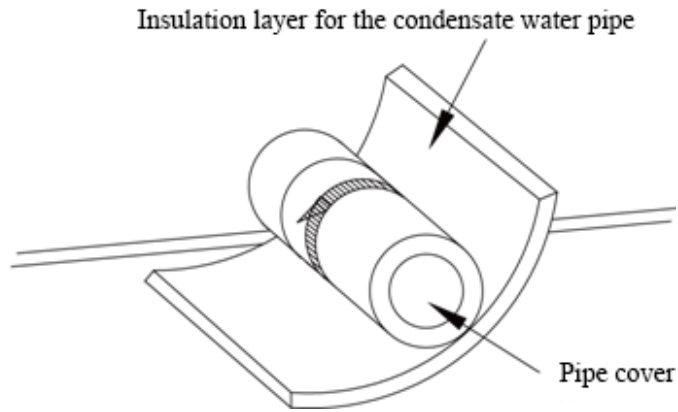

10.1.3.2 Drain pipe installation for cassette type IDU

1) Use pipe clips instead of applying glue to connect the hoses provided upon delivery and plastic pipes on the device. Connect the other end of the joint to the elbow. The height from the suction inlet of the discharge pump is about 200 to 500 mm. Ensure a proper inclination degree while connecting to the main drain pipe.

2) The lifting pipe for drainage must be provided as shown in the following figure:

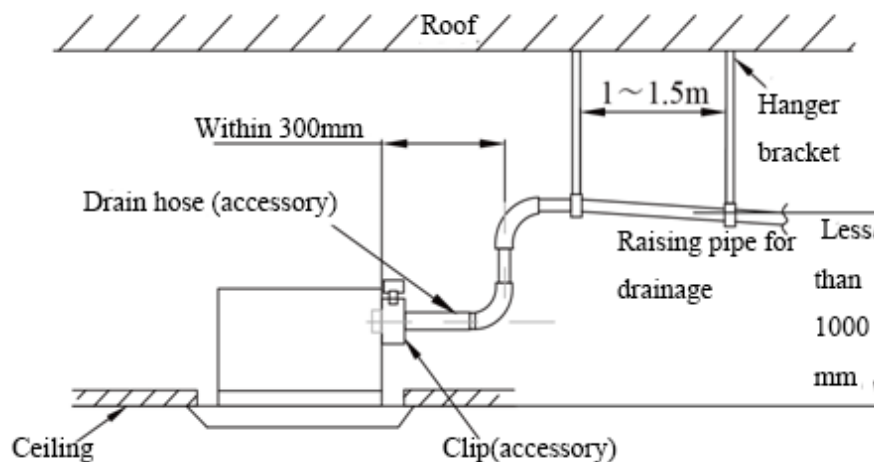

3) The drain pump shall be fixed securely. Otherwise, abnormal noises will be generated.

10.1.4 Drain test

Fill water to each IDU and check the water level of water tray and transparent condensate drain hose, to check if water can drain smoothly. If water cannot drain smoothly, check if the pipe is blocked or if the gradient of condensate pipe is not sufficient, and then solve the problem.

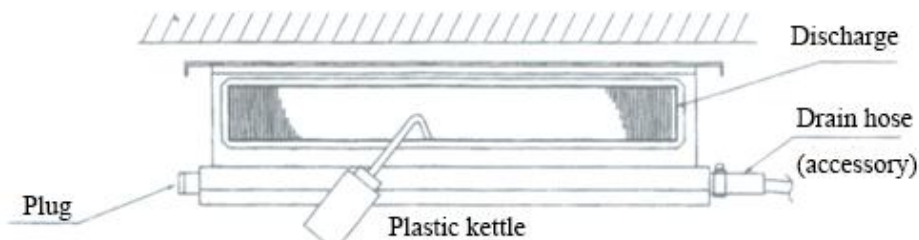

(Drain hose can be installed from the left side and right side.)

The drain pipe hose which is not used must be plugged.)

10.1.5 Full water test

1) Block the drain hole at the end of condensate pipe to ensure water can be kept in the pipe

during full water test;

2) Fill water from the water tray of unit to make water level of water tray higher than the top end of drain pipe. make the pipe full of water;

3) Check each joint of drain pipe to make sure there is no leakage.

10.1.6 Insulation for the condensate water pipe

A、Insulation materials

Use closed-cell foam insulation materials with retardant grade of B1.

The heat conductivity is not greater than 0.035 w/(m·k) when the average temperature is 0°C.

B、Thickness of the Insulation Layer

Thickness of the insulation layer for the condensate water pipe must be greater than 10 mm.

C、Bond the insulation material joints with special glue and then wrap them with plastic adhesive. The width of the adhesive must be greater than 5 cm to prevent dewing.

D、Insulation is not required for the outdoor part of condensate water pipes.

10.2 Insulation for air ducts

1) Insulation for air duct components and devices must be performed after the air leakage test is performed or after quality check.

2) Use centrifugal glass wool or rubber and plastic materials for insulation or use novel insulation air ducts.

3) The insulation layer should be flat and tight without any crack or gap.

4) Thickness of the insulation layer:

(1) For the air supply and return air duct laid in a room without an air conditioner, thickness of the rubber and plastic insulation layer is 35 mm.

(2) For the air supply and return air pipe laid in an air conditioning room, thickness of the rubber and plastic insulation layer is 20 mm.

5) Supports, hangers, and brackets of the air duct must be installed outside the insulation layer. A chock must be provided between the support, hanger, or brackets and the air duct.

11. Installation and Insulation of Hot Water System Pipeline

11.1 Connection of Hot Water System Pipeline

Hot water system pipeline mainly consists of circulating water inlet/outlet pipe between hydro box and water tank, water inlet/outlet pipe of water tank, floor heating water pipe between hydro box and floor heating room.

Preparation of Pipe: Hot water pipes are applied as circulating water inlet/outlet pipe. The PPR pipe with outer diameter DN25 which is S2.5 series (thickness is 4.2mm) is recommended. Hot water pipes are applied as inlet pipe for cold water and outlet pipe for hot water. The PPR pipe with outer diameter DN20 which is S2.5 series (thickness is 3.4mm) is recommended. All applied PPR pipes must comply with national standards GB/T18742. If other insulated pipeline are adopted, the above can be reference.

Installation of circulating pipes: the water inlet of hydro box shall connect with outlet of circulating pipe of water tank while the water outlet of hydro box shall connect with the inlet of circulating pipe of water tank. The manual vent valve A shall be vertically installed upward near the water inlet of hydro box. The manual vent valve B must be vertically installed downward beside the inlet of circulating pipe of water tank. If the conditions are permitted, install the manual vent valve B in the place which is convenient for users. The two vent valves above are equipped

with the unit.

Installation of water pipe of water tank: safety check valve, filter and cutoff valve must be installed in inlet pipe according to the installation diagram of the unit(pay attention to the direction of safety check valve: “→”on the valve shall point at water tank). At least one cutoff valve shall be installed for water outlet pipe.

Installation of blowing tube on the bottom of the water tank: Connect the drain vent with the floor drain by PPR pipe. A cutoff valve must be installed in the blowing tube and the cutoff valve must be installed in the place which is convenient for users.

After all pipelines have been installed, execute leak detection. If there is no leakage, execute insulation work to all pipelines, especially to the valve and pipe joints. Insulating cotton whose thickness is not less than 15mm is recommended. After wrapping the pipe with insulating cotton, bundle the pipe, water temp sensor and wires.

(1)Connection schematic diagram for hydro box and water tank

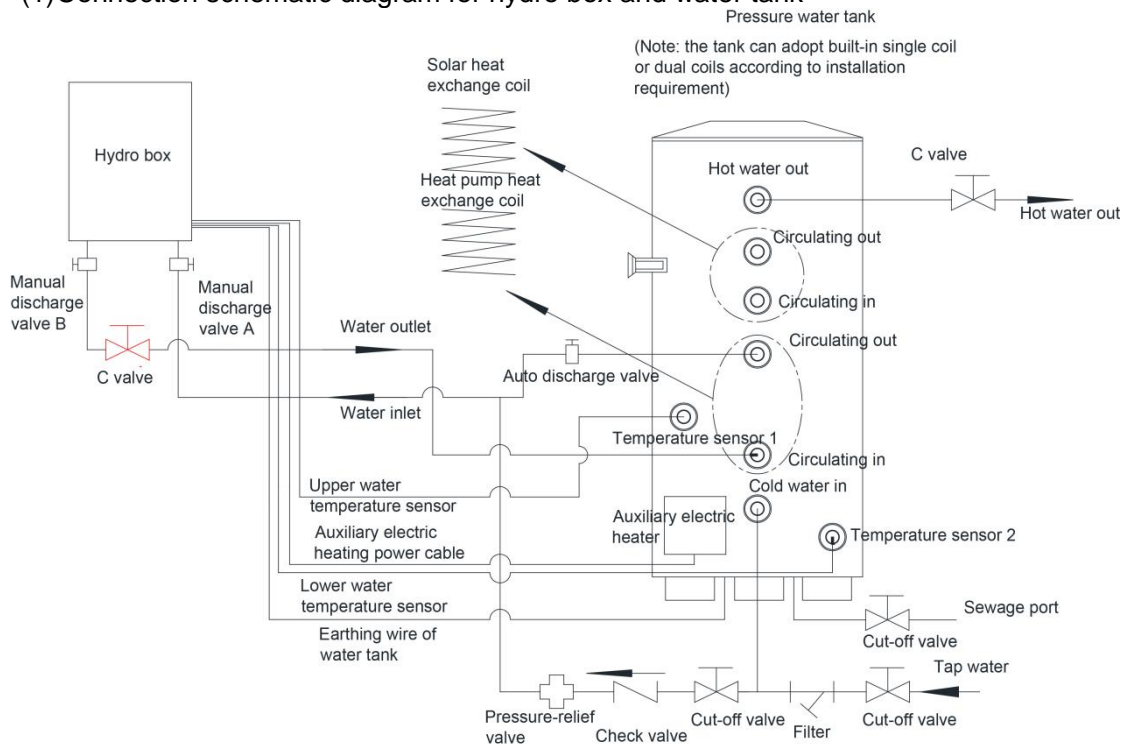

Note:

1. Only temp sensor in the bottom part is equipped in hydro box and the temp sensor in the upper part is self-provided by water tank.
2. Connect temp sensor port 1 of water tank with the water temp sensor on the upper part of hydro box.
3. Connect temp sensor port 2 of water tank with the water temp sensor on the lower part of hydro box.
4. The connection method of upper temp sensor is mutual connection in the air, connected with temp sensor port 2 of water tank.
5. If the water tank just has one temp sensor port, connect the temp sensor on the upper part of hydro box with temp sensor port of water tank.

(2) Connection schematic diagram for hydro box and floor heating

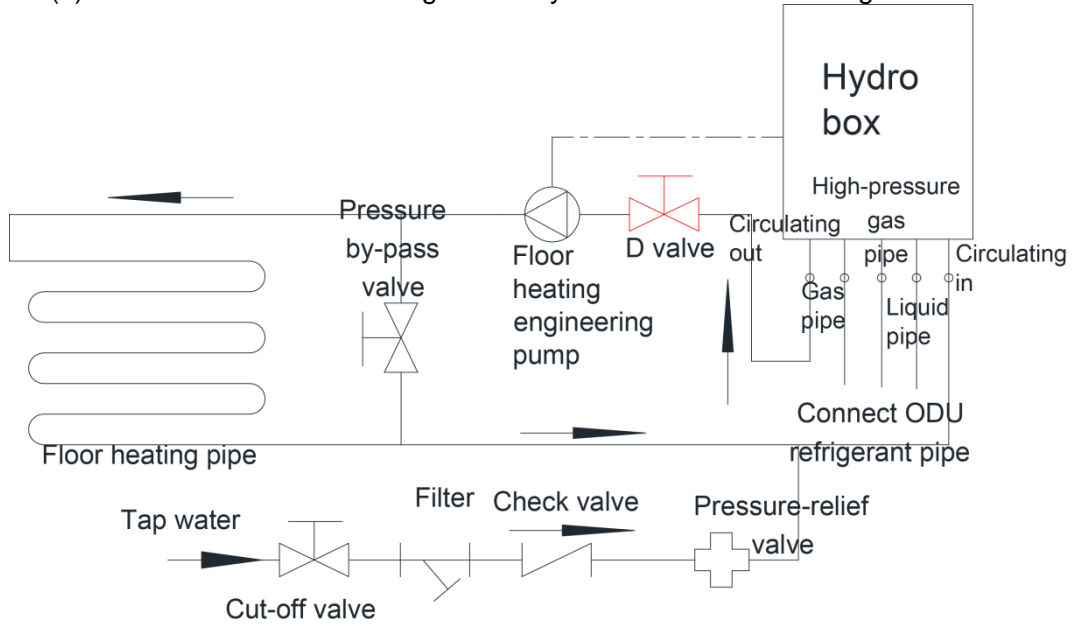

(3) Schematic diagram of solar water heater connected with the system for heating

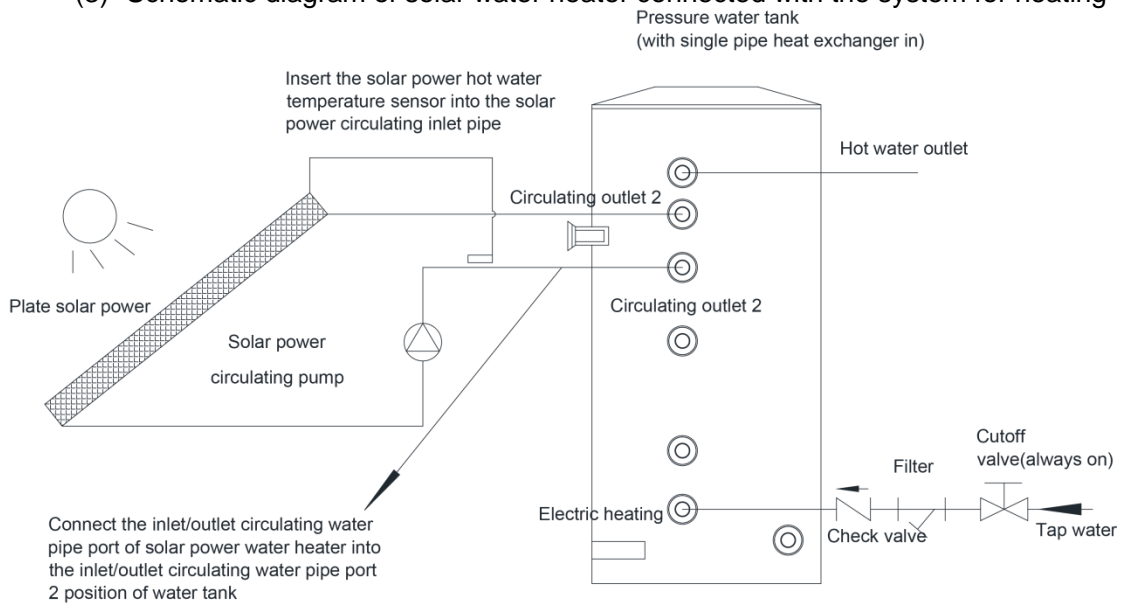

(4) Connection schematic diagram of hydro box with water tank and floor heating

GMV5 Home DC Inverter Multi VRF Units

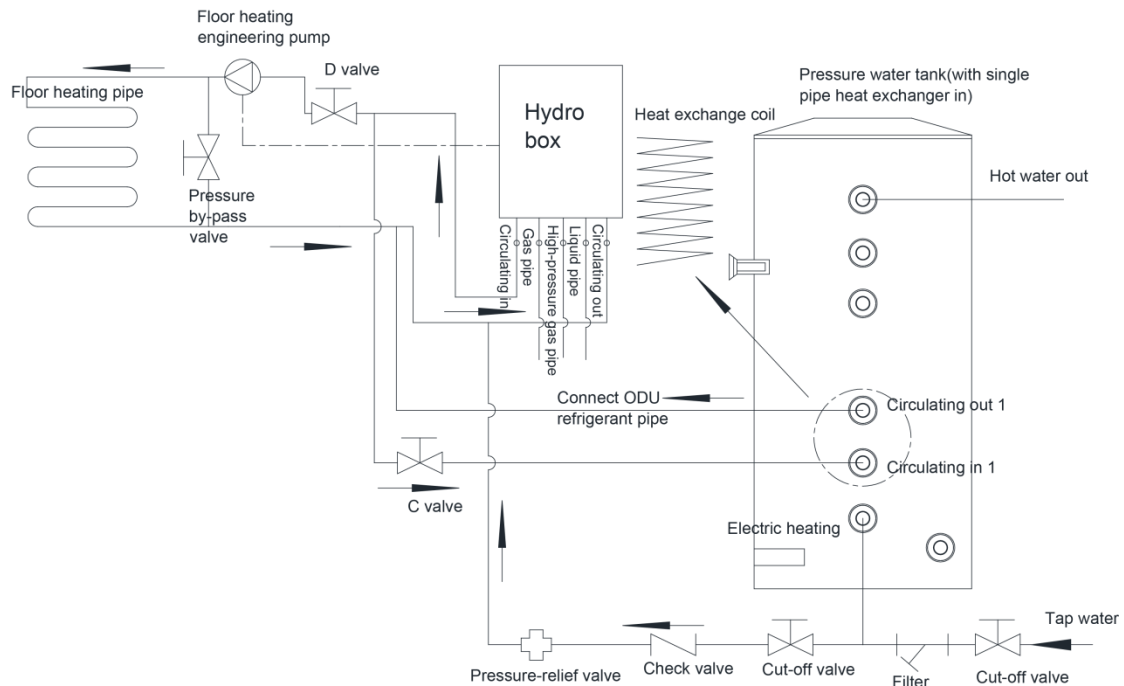

Note:

1. The horizontal distance between hydro box and thermal insulation water tank shall not exceed 5m, and the vertical fall shall not exceed 3m. It is recommended to install the water tank at lower and install the hydro box at upper.

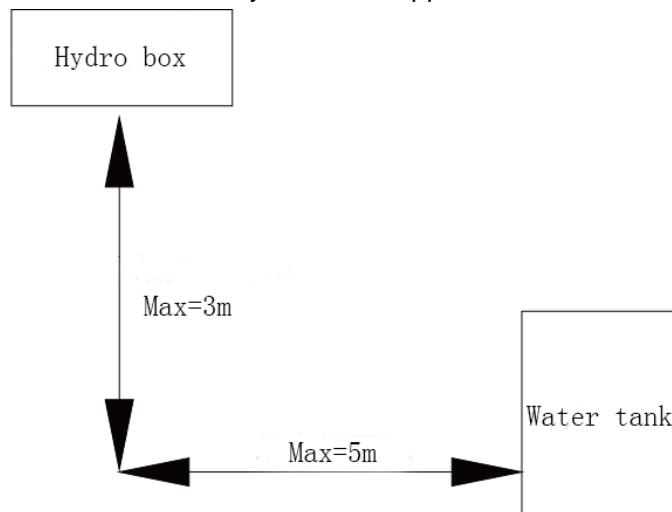

2. If the total waterpower loss between floor heating pipeline and valves exceeds 6m, please add floor heating engineering pump behind the solenoid valve D. There is control interface reserved in the electric box of hydro box. Please connect wire according to the wiring diagram on the electric box.
3. Prepare materials according to connector size and specification above. If the cutoff valve is installed outdoors, it is recommended to use PPR fittings, thus to avoid freezing under low temperature.
4. The hydro box shall be properly fixed before proceeding to installation of water pipes. During installation of the connection pipe, prevent the dust or other foreign articles from entering the pipe system.
5. The thermal insulation pressure water tank is supplied of hot water based on tap water pressure. The user can have hot water only when there is tap water.
6. During use, the cutoff valve at the cold water inlet of water tank shall be kept normally open.
7. If you put the unit out of use for a long period and cut off the power, please make sure to drain the water thoroughly out of the hydro box and floor heating pipe, in order to prevent

the system from freezing.

11.2 Connection Requirements of Hydro box and water Tank

Connect hydrobox with water tank by water pipe which can be galvanized pipe or seamless steel pipe, like PVC pipe, PPR pipe, etc.

Size of interface	
Name	Screw of joint
Circulating water inlet/outlet of hydro box	G1A
Cold water inlet of water tank	G1/2
Circulating water inlet/outlet of water tank	G3/4
Hot water outlet of water tank	G1/2
Pipe joint	G3/4

Note:

The circulating water pipe shall be insulated with insulating material whose thickness is not less than 15mm.

The circulating water pipe shall be sealed to prevent water leakage.

11.3 Installation Requirements of Water System

- (1) The cold water inlet of pressure water tank shall be connected to tap water pipe, and the hot water outlet shall be connected to the water terminal.
- (2) The tap water inlet shall be connected with one-way valve, filter and relief valve.
- (3) For easy repair, manual cutoff valve shall be installed at water inlet or outlet.
- (4) Exhaust valve shall be installed at the highest position of water pipe.
- (5) To avoid waiting too long when using hot water, please add hot water return line if the water terminals are dispersed and the water tank is far from such terminals.
- (6) If possible, please equip an expansion tank. Generally, the size of expansion tank shall be 5~10% of the size of the whole water system.

11.4 Capacity Setting of Water Tank

The ex-factory defaulted capacity of water tank is 300L. If the actually installed water tank capacity is smaller than 300L, setting is not needed. If the actually installed water tank capacity is bigger than 300L, please arrange the following setting.

GMV5 Home DC Inverter Multi VRF Units



Step 1: Under water heating and floor heating off status (unit on status is ok)
Note: LCD is under awoken status;



Step 2: Hold on pressing "FUNCTION" button for 5s and then C00 will be displayed;



Step 3: Press "MODE" button for 3 times within one second;

Note: During operation, "Invalid" icon blinks twice and the buzzer gives out two short sounds and one long sound;



Step 4: Hold on pressing "FUNCTION" button for 5s and then P00 will be displayed;



GMV5 Home DC Inverter Multi VRF Units



Step 5: Press “▲” or “▼” button to enter P60;



Step 6: Press “MODE” button to enter hydro box selection setting;

Note: When only one hydro box is under control, it will enter Step 9 directly;



Step 8: Press “MODE” button to enter water tank capacity setting;



Step 7: Press “▲” or “▼” button to select the sequence(1~3) of hydro box for setting;

Note: If selection is not needed, next step can be entered;



Step 9: Press “▲” or “▼” button to set water tank capacity;



Step 10: Press “ENTER/CANCEL” button to confirm the water tank capacity setting of current hydro box;

Note: 1. If you need to set the water tank capacity of other hydro box, please repeat step 6 to step 10 (for one wired controller controlling several units or several wired controllers controlling several units);

2. When all setting operation has been done, press “ON/OFF” button to exit parameter setting directly or press “ENTER/CANCEL” button to return P60;

11.5 Installation of Floor Heating Performer (floor heating water separation valve)

When connecting floor heating, floor heating performer is recommended to be installed, so that you can control each room separately in order to save energy. This hydro box is with floor heating performer interface (single phase 220V), which can be connected with the floor heating performer. Through setting the linkage between IDU wired controller and floor heating performer, indoor wired controller can control the startup of floor heating performer in that room. Indoor wired controller can set the ambient temperature of corresponding room and control the startup/shutdown of floor heating of that room.

- (1) Before installation, please make sure the performer is normally closed type.
- (2) The wiring of floor heating water separation valve in the performer is according to the wiring diagram.
- (3) Connect a pressure bypass valve between the performers.
- (4) The circulating out of hydro box is connected with floor heating water separator and the circulating in of hydro box is connected with floor heating water collector.

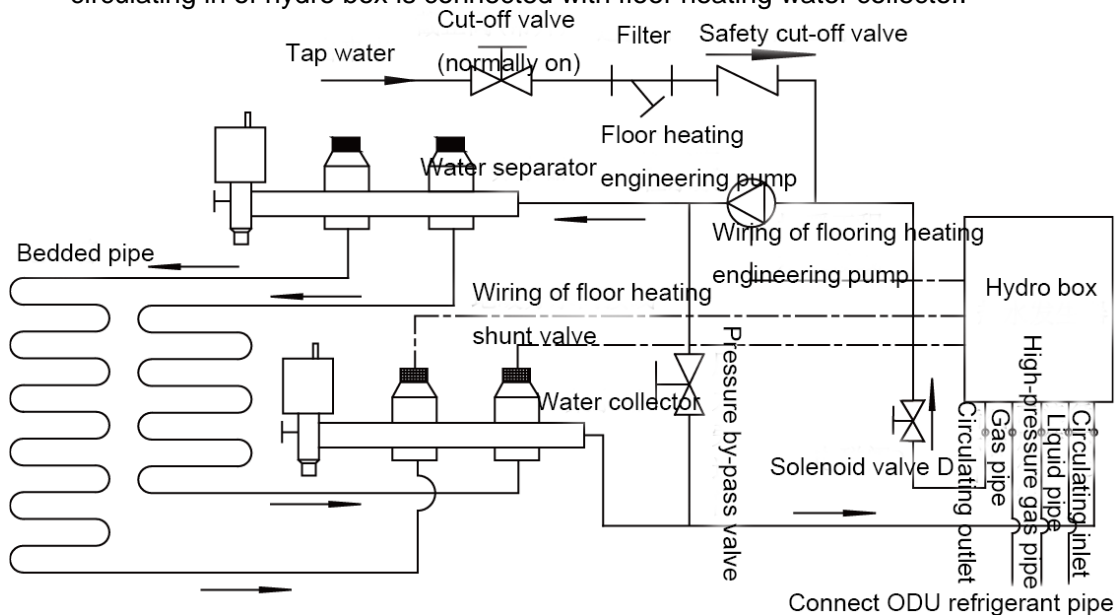

- (5) The corresponding setting relationship between floor heating water separation valve and IDU:



Notices:

- ① The corresponding relationship setting must be done in unit off status.
- ② Only the IDU connected with wired controller and floor heating can be set for corresponding relationship (linkage). The IDU connected with light board or controlled by wireless remote controller cannot be set!

Step 1: Confirm the IDU project no. which is in the same room with floor heating and the corresponding floor heating shunt valve no.:

- 1) Check the IDU project no. in its wired controller. For example: The IDU project no. in this room is "9".
- 2) Check the floor heating shunt valve no. connected with the floor heating in the electric box of hydro box. For example: The floor heating shunt valve no. is "floor heating shunt valve 3".
- 3) Make sure the IDU is in accordance with the floor heating shunt valve. As the examples above, floor heating shunt valve 3 is in accordance with IDU project no. 9.

Step 2: Setting of corresponding relationship(linkage) is shown as below:

GMV5 Home DC Inverter Multi VRF Units



Step 1: Under water heating and floor heating off status (unit on status is ok)
Note: LCD is under awoken status;



Step 2: Hold on pressing “FUNCTION” button for 5s and then C00 will be displayed;



Step 3: Press “MODE” button for 3 times within one second;
Note: During operation, “INVALID” icon blinks twice and the buzzer gives out two short sounds and one long sound;



Step 4: Hold on pressing “FUNCTION” button for 5s and then P00 will be displayed;



Step 5: Press “▲” or “▼” button to enter P79;



Step 6: Press “MODE” button to enter hydro box selection setting;
Note: When only one hydro box is under control, it will enter Step 8 directly;



GMV5 Home DC Inverter Multi VRF Units



Step 8: Press "MODE" button to enter shunt valve selection setting;

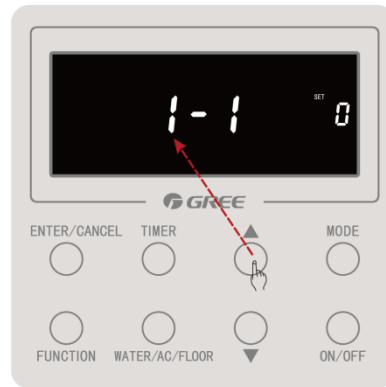

Step 7: Press "▲" or "▼" button to select the sequence(1`3) of hydro box for setting;
Note: If selection is not needed, next step can be entered:



Step 9: Press "▲" or "▼" button to select the sequence(1`6) of shunt valve for setting;
Note: If selection is not needed, next step can be entered;



Step 10: Press "MODE" button to enter indoor unit selection setting



Step 12: Press "ENTER/CANCEL" button to confirm the setting of current shunt valve and indoor unit;
Note: 1. If you need to set the shunt valve and indoor unit of other hydro box, please repeat step 6 to step 12 (for one wired controller controlling several units or several wired controllers controlling several units) or repeat step 8 to step 12 (for one wired controller controlling one unit);
2. When all setting operation has been done, press "ON/OFF" button to exit parameter setting directly or press "ENTER/CANCEL" button to return P79;
3. Cancel of shunt valve setting is the same as the setting step of shunt valve. The difference is that when set the IDU project no. into 0, the matching is invalid, which means cancel the setting of that shunt valve; if you need to cancel all matching, please set all IDU project no. in matching into 0;

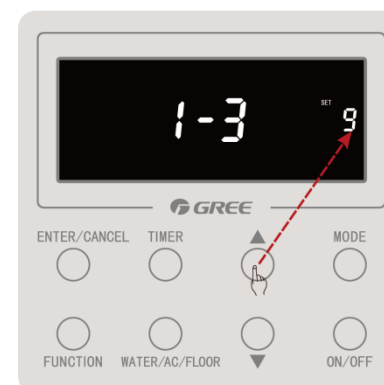

Step 11: Press "▲" or "▼" button to select the indoor unit(project no. 1`255) for setting;
Note: If selection is not needed, next step can be entered;

12. Electric Installation

12.1 Precautions



Dangerous!

- ① The electric installation personnel must get related qualification.
- ② The air conditioning unit is category 1 electrical appliance which requires reliable grounding.
- ③ The grounding resistance must meet the requirement of local law.
- ④ The yellow green cable inside the air conditioning unit is a grounding cable. It cannot be used for other purposes or be cut off. Do not fix it with tapping screws. Otherwise, an electric shock may be caused.
- ⑤ A reliable grounding terminal must be provided for the power. Do not connect the grounding cable to any of the following:
 - a. Water pipes; b. Gas pipes; c. Drainage pipe; d. Other places deemed as unreliable.
- ⑥ The power cable and the communication cable must be laid separately with a distance of greater than 20cm. Otherwise, the communication of the unit will be affected.
- ⑦ Both the power cable and communication cable must be connected properly. If the power cable is connected to the communication port, the main board will be burnt.

During installation, the power cable and communication cable can be identified in the following ways:

Method 1: Use sheaths in different colors.

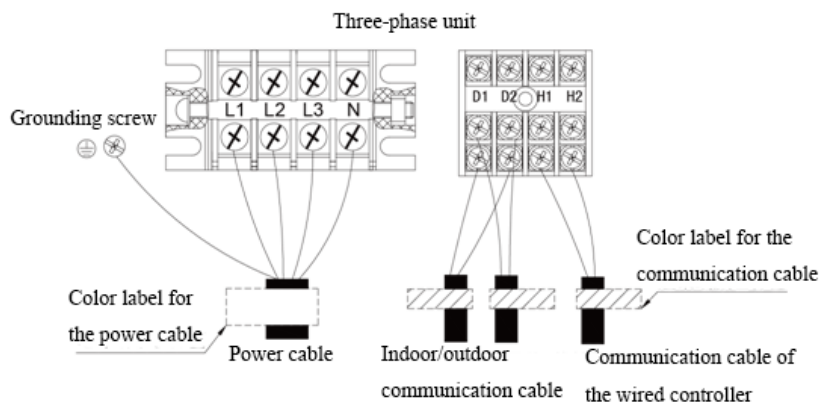
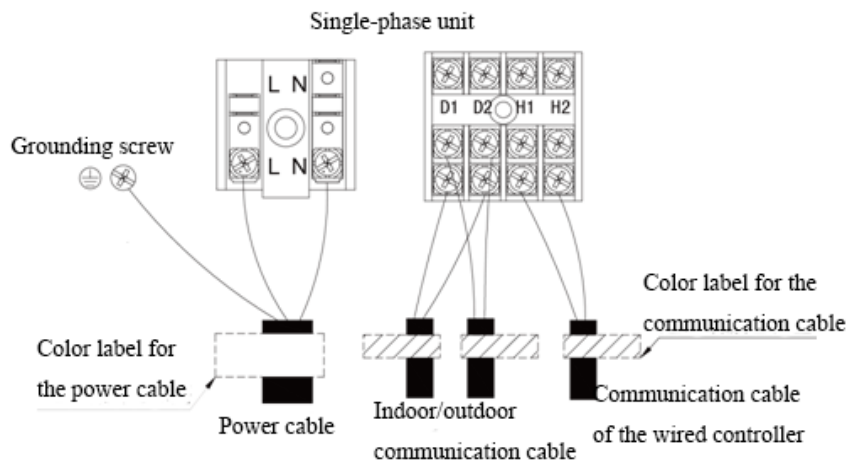

The diameter of the power cable is larger than that of the communication cable. Alternatively, adopt three cores or more for the power cable and two cores for the communication cable.

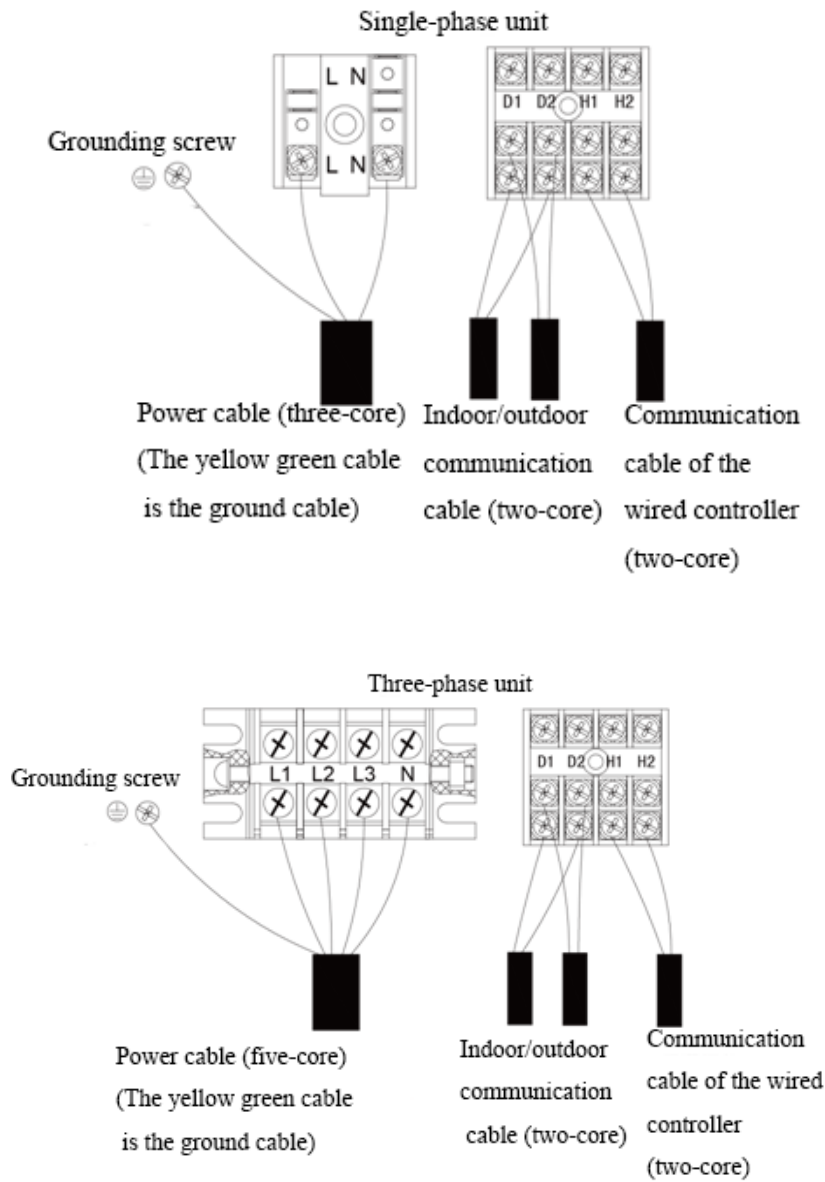

Elaborate the method with the installation personnel on site no matter which method is adopted.

12.2 Installation of Power

12.2.1 Procedure for installing the power cable

Step 1: Knock off the knockouts used for threading the external power cable, fit the threading rubber ring to the hole, and thread the power cable through the hole. Connect L1, L2, L3, and N of the power cable, and the grounding cable to L1, L2, L3, and N on the power terminal block and the grounding screw next to the terminal block respectively.

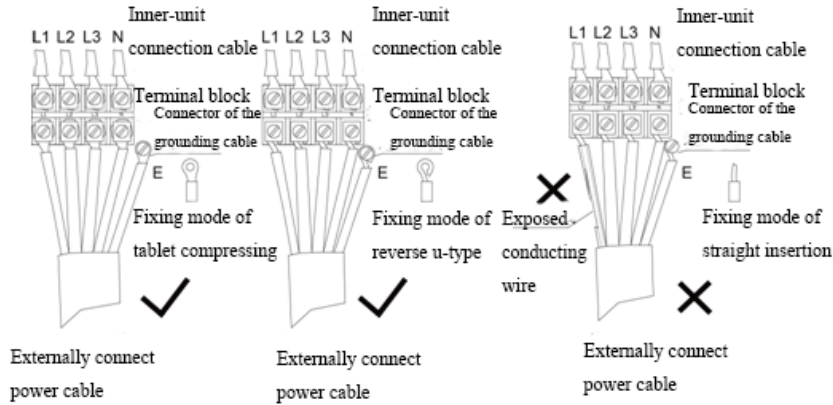

Step 2: Fasten and fix the power cable with ties (support heads).

Step 3: Lay the power cable and communication cable for the ODU according to the following figures:

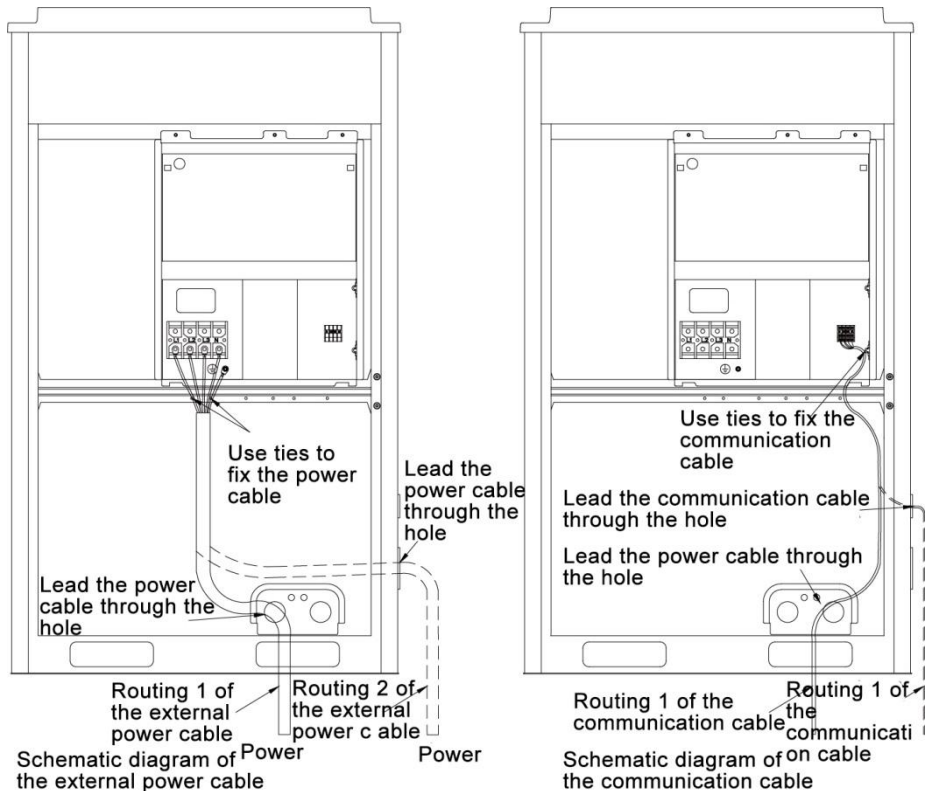

Warning! Provide a threading rubber ring when threading a strong power cable or a communication cable.

12.2.2 Power cable diameter and circuit breaker selection

Each unit shall be equipped with a circuit breaker for shortcircuit and abnormal overload protection. IDUs and ODU shall be set with the main circuit breaker separately, for connecting or cutting off the main power.

12.2.2.1 ODU

The circuit breaker and power cable diameter of ODU can refer to the following table:

GMV5 Home DC Inverter Multi VRF Units

Model	Power supply	Capacity of circuit breaker (A)	Min. sectional area of grounding wire (mm ²)	Min. sectional area of power cable (mm ²)
GMV-S224W/A-X	380V 3N~50Hz	20	2.5	2.5
GMV-S280W/A-X	380V 3N~50Hz	25	2.5	2.5

Note:

- ① The circuit breaker must support magnetic release and thermal release at the same time to protect the system from short circuit and overload.
- ② The power cable specification means the selected specification when BV single-core wire(2~4 pcs) goes through plastic pipe in ambient temperature of 40°C and the circuit breaker operates in 40°C. If the actual installation condition changes, please refer to the instruction manual for power cable and circuit breaker provided by the manufacturer.
- ③ The circuit breaker shall adopt D type circuit breaker.
- ④ The sectional area of a wire is applicable for a distance range of up to 15 m. If the distance is greater than 15 m, increase the sectional area of the wire correspondingly to prevent the wire from being burned due to overload current and to avoid fire.

12.2.2.2 Hydro box

The circuit breaker and power cable diameter of hydro box can refer to the following table:

Model	Power supply	Capacity of circuit breaker (A)	Min. sectional area of power cable (mm ²)		
			Live wire	Neut ral wire	Grounding wire
NRQD16G/A-S	220V~50Hz	32	6	6	6

Note:

- ① The power cable must be copper cable with operation temperature not higher than the specified value.
- ② If the length of power cable is longer than 15m, please increase the sectional area of power cable in order to avoid hazards caused by overload.
- ③ The power cable specification means the selected specification when BV single-core wire(2~4 pcs) goes through plastic pipe in ambient temperature of 40°C and the circuit breaker operates in 40°C. The circuit breaker shall adopt D type circuit breaker.
- ④ If the actual installation condition changes, please refer to the instruction manual for power cable and circuit breaker provided by the manufacturer.

12.2.2.3 IDU

For information about the leakage circuit breaker for an indoor unit, refer to the following table. The circuit breaker capacities listed in the following table indicate the circuit breaker capacities when all indoor units in the same system are connecting connected to the main power.

Total capacity of indoor units	Capacity of circuit breaker (A)	Min. sectional area of power cable (mm ²)	Min. sectional area of grounding wire (mm ²)
below 10A	10	1.0	1.0
16~10A	16	1.5	1.5

GMV5 Home DC Inverter Multi VRF Units

20~16A	20	2.5	2.5
32~20A	32	4.0	4.0
40~32A	40	6.0	6.0
50~40A	50	10.0	10.0
63~50A	63	16.0	16.0
80~63A	80	25.0	16.0
100~80A	100	35.0	16.0
125~100A	125	50.0	25.0

The breaker capacity and power cable specifications when a circuit breaker is installed on each indoor unit independently.

IDU model	Capacity of circuit breaker (A)	Min. sectional area of grounding wire (mm ²)	Min. sectional area of power cable (mm ²)
Wall-mounted type	6	1.0	1.0
Duct type(pure heat pump)	6	1.0	1.0
Cassette type(pure heat pump)	6	1.0	1.0
One-way cassette	6	1.0	1.0

If the IDU is with auxiliary electric heating, please select the capacity of circuit breaker according to the capacity of auxiliary electric heater. Please refer to the following table.

IDU model (with auxiliary electric heater)	Capacity of circuit breaker (A)	Min. sectional area of grounding wire (mm ²)	Min. sectional area of power cable (mm ²)
22, 25, 28, 32, 36 duct type unit	6	1.0	1.0
40, 45, 50 duct type unit	10	1.0	1.0
56, 63, 71, 80 duct type unit	16	1.5	1.5
90, 100, 112, 125, 140 duct type unit	10	1.0	1.0
28, 36, 45, 50 cassette type unit	6	1.0	1.0
56, 63, 71, 80 cassette type unit	10	1.0	1.0
90, 112, 125, 140 cassette type unit	6	1.0	1.0



Note:

- ① The circuit breaker and power cable specifications are selected based on the maximum power (maximum current) of the units.
- ② The power cable specifications are obtained under the conditions that the ambient temperature is 40°C, the working temperature of multi-core copper cable (for example, YJV cable) is 90°C, and the cable is exposed in cable troughs. In different applications, adjust the specifications based on national standards.
- ③ Only copper cable can be used.
- ④ The sectional area of a wire is applicable for a distance range of up to 15 m. If the distance is greater than 15 m, increase the sectional area of the wire correspondingly to prevent the wire from being burned due to overload current and to avoid fire.
- ⑤ The circuit breaker specifications are obtained under the conditions that the ambient temperature is 40°C when the circuit breaker is working. In different applications, adjust the specifications based on the circuit breaker manual.
- ⑥ The circuit breaker must support magnetic release and thermal release at the same time to protect the system from short circuit and overload.

12.2.3 External wiring diagram of unit

12.2.3.1 ODU with hydro box and IDU

 Note:

Each unit shall be equipped with a circuit breaker for shortcircuit and abnormal overload protection. IDUs and ODU shall be set with the main circuit breaker separately, for connecting or cutting off the main power.

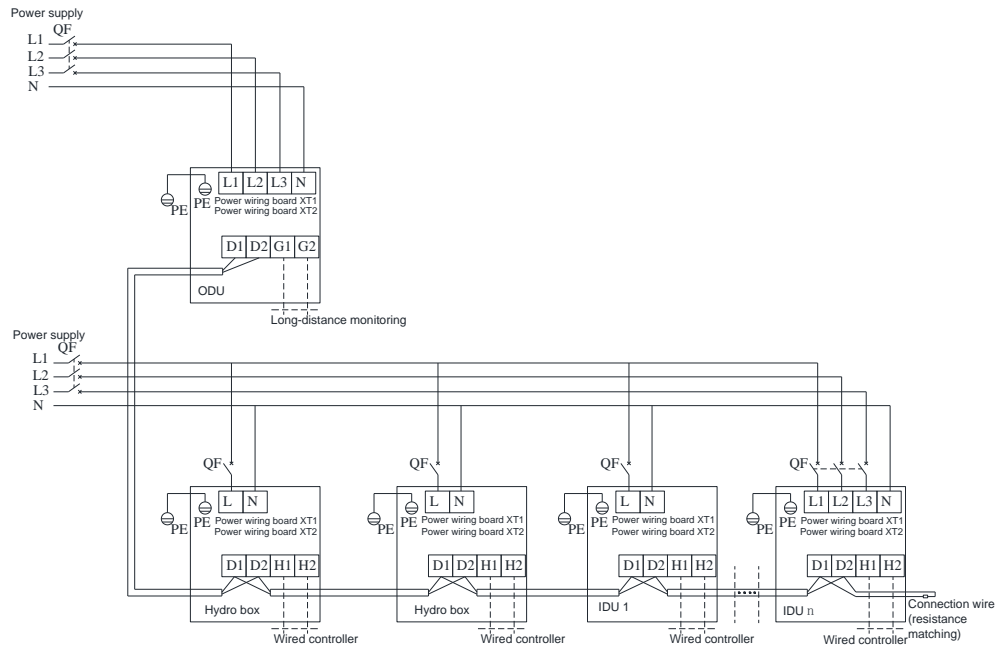

12.2.3.2 Hydro box and water tank

(1) Electric wiring and connection

- (1) Loosen the screws fixing the electric box cover on the hydro box. Open the electric box cover.
- (2) Connect one end of the electric heating power cable included on the water tank to the terminal board of the main unit. The specific wiring terminal please refer to the wiring diagram.
- (3) Apply heat conductive silicone gel onto the water temperature sensor which leads out from the hydro box, and then insert it into the lower water temperature sensor port at the lower part of water tank. Connect the upper water temperature sensor included on water tank (i.e. upper temperature sensor port in the middle of water tank) to the red connector leading out from the terminal box on hydro box. Then, put it into electric box.
- (4) Tighten the strong current cables with cable clamp and cover up the electric box.
- (5) The wired controller shall be fixed properly. The communication wires from wired controller and hydro box shall be correctly connected.
- (6) Take care to route the strong current cables separately from the light current cables.

GMV5 Home DC Inverter Multi VRF Units

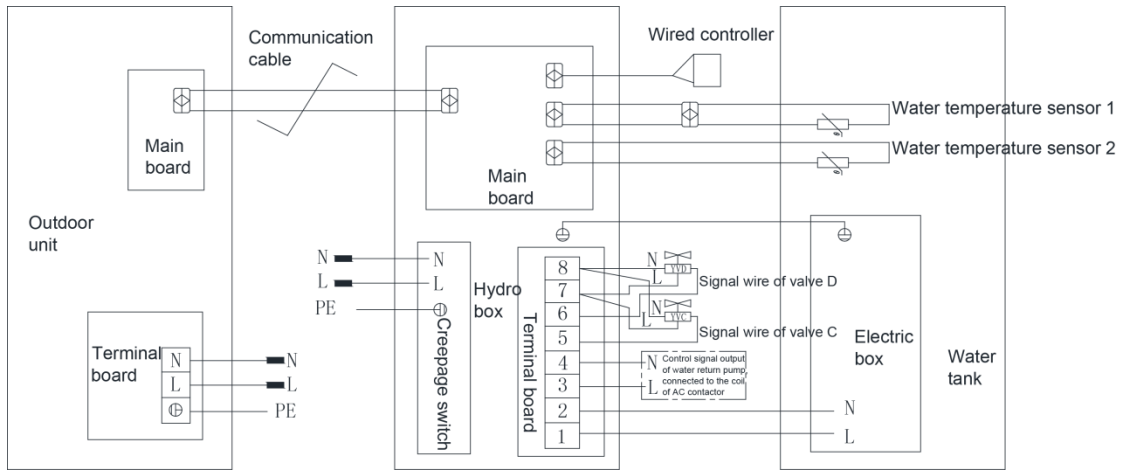

Note: The above wiring diagram is only for reference. Detailed content please refer to the wiring diagram stuck inside the electric box of unit.

(2) Confirm DIP of mainboard

Confirm the S₁ and S₂ DIP switch on the main board of hydro box. S₁ DIP means capacity DIP switch. S₂ DIP means function DIP.

Capacity DIP(S₁) of Hydro Box

Capacity DIP switch S₁ is 5 bit. Please do not change it.

Capacity of hydro box	Capacity DIP switch				Model DIP switch
	1	2	3	4	5
16	ON	OFF	OFF	ON	OFF

Note:

- ① DIP switch shall be set correctly and cannot be set in the middle position. When the switch is set to "ON", it means "0"; when the switch is set to the opposite direction of "ON", it means "1".

Example: S₁ is as shown in the following figure:

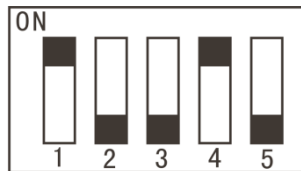

- ② The black part is the bar for setting DIP.

(S₂) Function DIP (S₂) of hydro box

Note: Please set strictly according to actual situation of project.

Function DIP S₂ of hydro box has 4 digits. "1", "2", "3" and "4" mean "Gree water tank", "floor heater", "solar power", "self-made water tank" respectively. The DIP of each function is applicable: setting to "number" means this function is connected; setting to "ON" means not connected. "1" and "2" must be set according to the actual situation of project. "3" and "4" cannot be changed, otherwise the unit may occur temperature sensor error or cannot operate.

DIP sequence	Meaning	DIP		Ex-factory setting
		Not connected	Connected	
1	Gree water tank	ON	OFF	OFF
2	Floor heating	ON	OFF	OFF
3	Solar power	ON	OFF	ON
4	Self-made	ON	OFF	ON

	water tank	
--	------------	--

For example, S2 as shown in the figure:

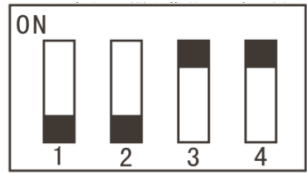

Note: The black part is the dial rod.

12.3 Wiring diagram

12.3.1 Wiring diagram of ODU

Wiring diagram of GMV-S224W/A-X, GMV-S280W/A-X

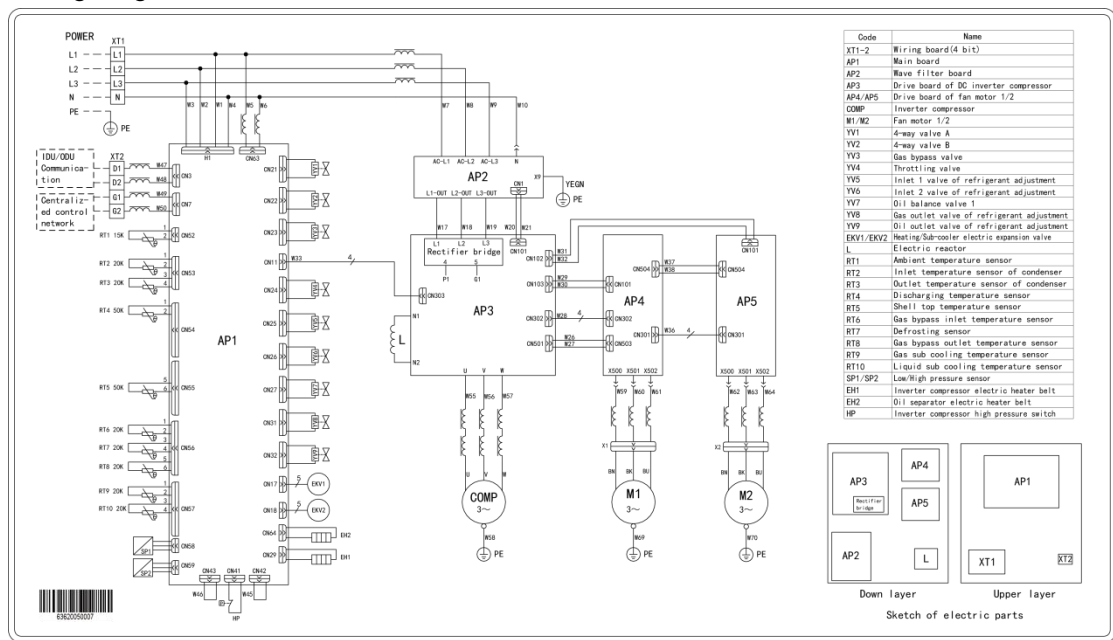

Note: The above wiring diagram is only for reference. Detailed content please refer to the wiring diagram stuck in the electric box of unit.

12.3.2 Wiring diagram of hydro box

Electric principle diagram of NRQD16G/A-S

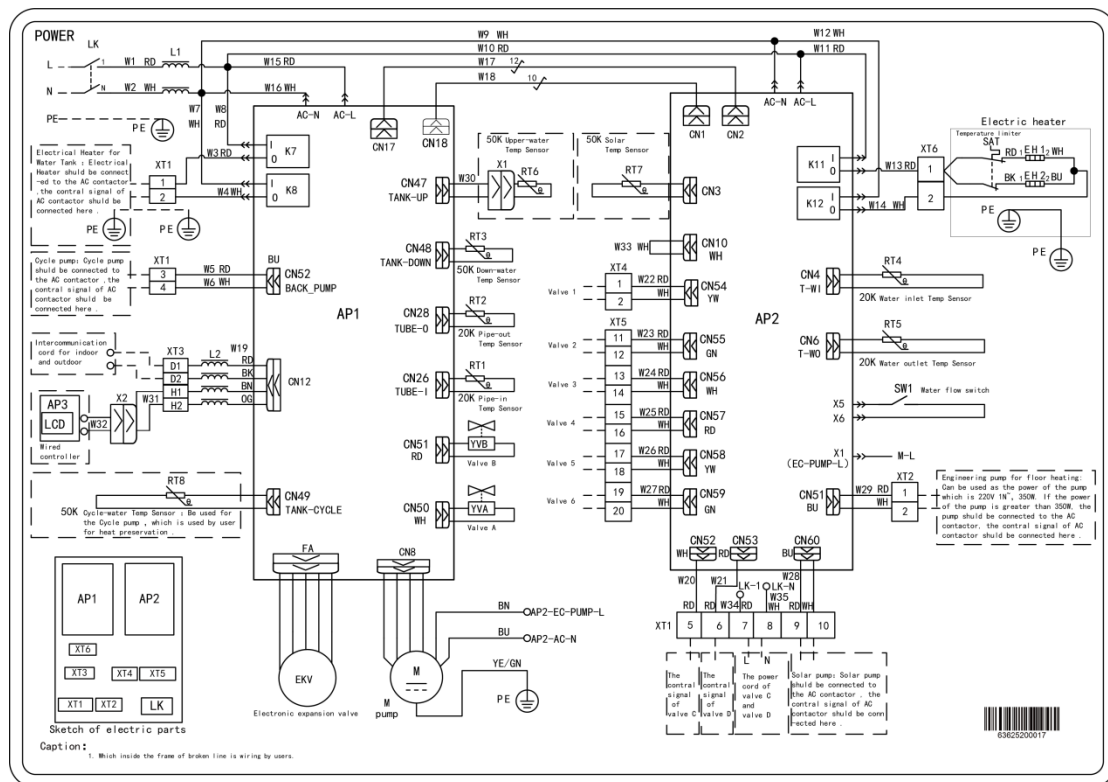

Note: The above wiring diagram is only for reference. Detailed content please refer to the wiring diagram stuck in the electric box of unit.

12.3.3 Wiring diagram of IDU

Please refer to the related manual of IDU.

12. Installation of the Communication System

The CAN communication network is adopted for GMV5 Home. Manual DIP or identification on polarities of the communication cable is not required for the IDU. Only the function DIP needs to be set for the ODU. For details, see the description on function setting of the ODU.

12.1 Connection of Communication Cable

12.1.1 Communication connection includes the following parts:

- (1) Communication between ODU and indoor units (hydro box, IDUs).
- (2) Communication between indoor units (hydro box, IDUs) and indoor units (hydro box, IDUs).
- (3) Communication between IDU and wired controller.
- (4) Communication between IDU and light board.
- (5) Communication between hydro box and wired controller.

12.1.2 Communication way

GMV5 Home adopts CAN bus communication way.

12.1.3 Selection of the material of communication cable

 Note:

For air conditioning units installed in places with strong electromagnetic interference, shielded wire must be used as the communication cables of the indoor units and wired controller, and shielded twisted pairs must be used as the communication cables between indoor units and

between the IDU and ODU.

(1) Communication cable selection for IDUs/hydro box and wired controller

Wire type	Total length of communication cables of the IDU and wired controller L(m)	Number of wire pieces x wire diameter (mm ²)	Wire standard	Remark
Common sheath twisted pair copper core (RVVS)	L≤250	≥2×0.75	GB/T 5023.5-2008	The overall communication length cannot exceed 250m.
Common shielded sheath twisted pair copper core (RVVSP)	L≤250	≥2×0.75	GB/T 5023.5-2008	If the unit is installed in places with strong electromagnetic interference, shielded wire must be used (RVVSP).

Connection between IDU and wired controller is shown as below:

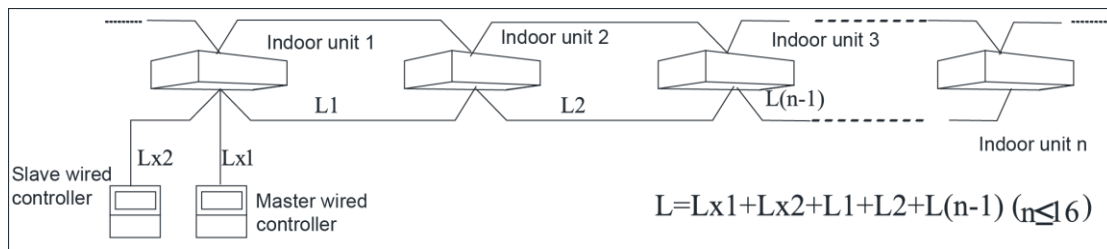

Connection between hydro box and wired controller is shown as below:

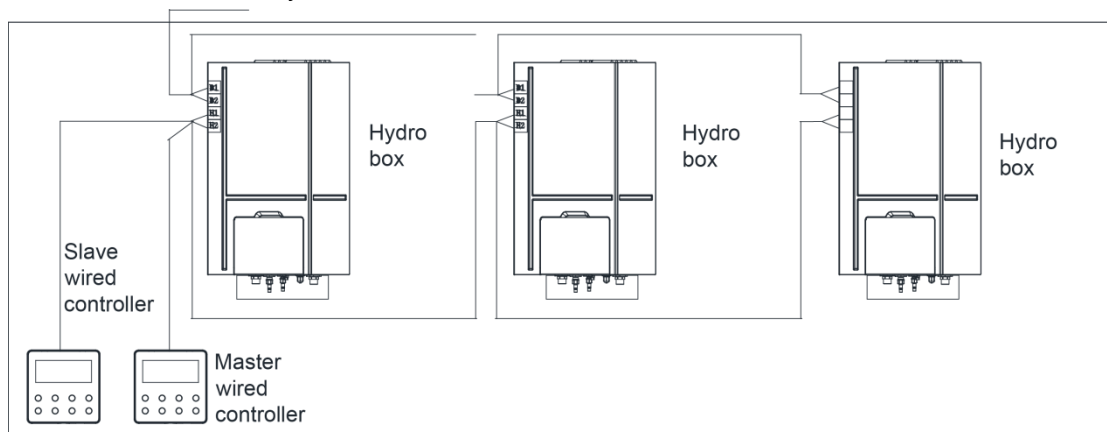

(2) Communication cable selection for ODU and IDUs/hydro box

Type of wire	Total length of communication wire between indoor unit and another indoor unit (outdoor unit): L(m)	Wire size (mm ²)	Material standard	Remarks
Light/Ordinary PVC sheathed twisted-pair copper core wire (RVVS)	L≤1000	≥2×0.75	IEC 60227-5:2007	If wire size is enlarged to 2×1mm ² , communication wire could be longer, but the total length shall not exceed 1500m.
Shielded light/ordinary PVC sheathed twisted-pair copper core wire (RVVSP)	L≤1000	≥2×0.75	IEC 60227-5:2007	If unit is installed in a place with intense magnetic field or strong interference, it's necessary to use shielded wire (RVVSP).

12.1.4 Connection of communication cables

- (1) Communication lead wire of indoor and outdoor units must be connected in series instead of in star mode. The terminal unit of communication lead wire of indoor and outdoor units must be connected with communication matched resistance (Single unit system is provided as the assembly of outdoor unit).

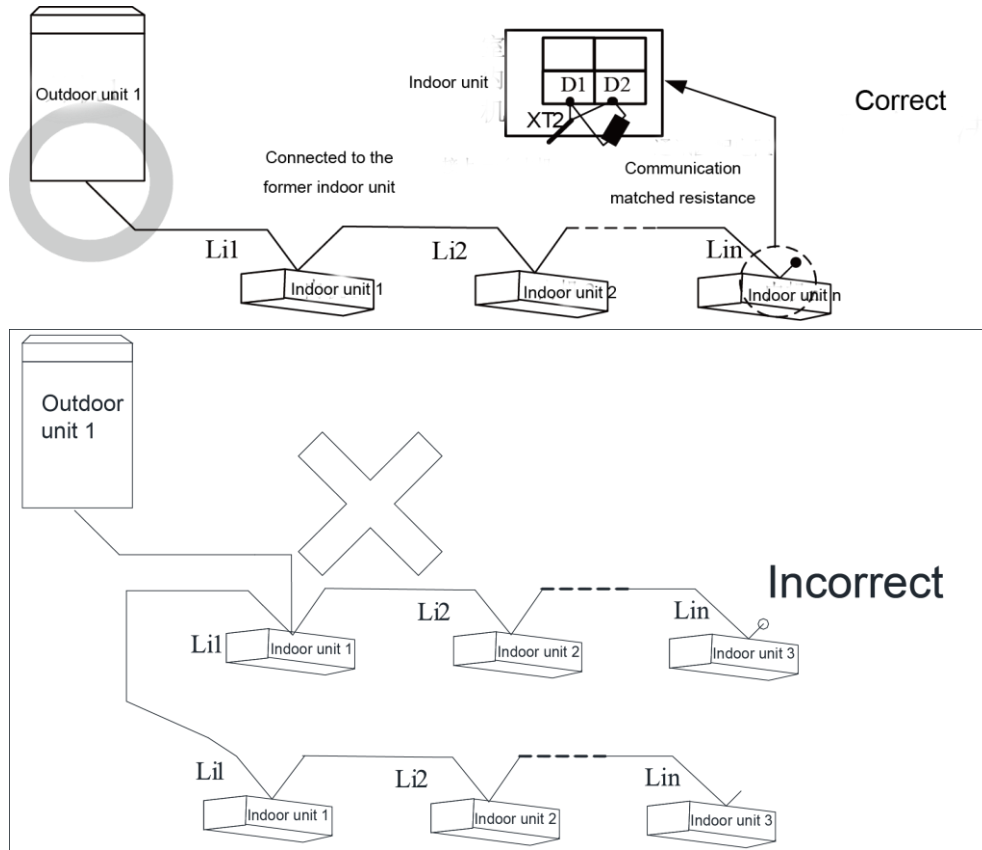

- (2) Connection of communication terminal: All connection wires must be secured with screws.

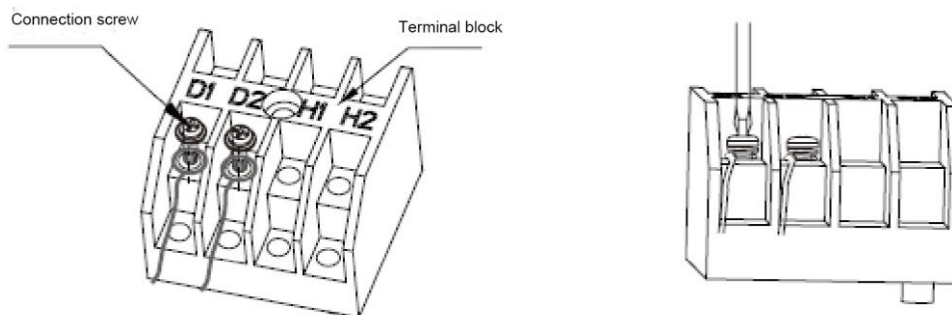

- (3) If a communication wire is not long enough and needs to be connected with another wire by peeling away its outer layer, crimp connection or soldering connection must be adopted.

12.2 Setting of Communication Address

Auto addressing technology is adopted. Manual setting of address is not needed.

12.3 Connection Way and Procedures of Communication Cable

12.3.1 Connection of communication cable between ODU and IDUs/hydro box

Open the electric box cover of ODU, IDU and hydro box. The communication wire goes to the electric box from the hole. Connect the wires of ODU, IDUs and hydro box according to the wiring diagram stuck on the unit. The selection of specifications of power cable please refer to the unit's power capacity, installation environment. After confirmation, the connection of ODU, IDUs and hydro box are arranged through D1/D2 port of wiring board XT2. Then install the electric box cover. Please refer to the following figure:

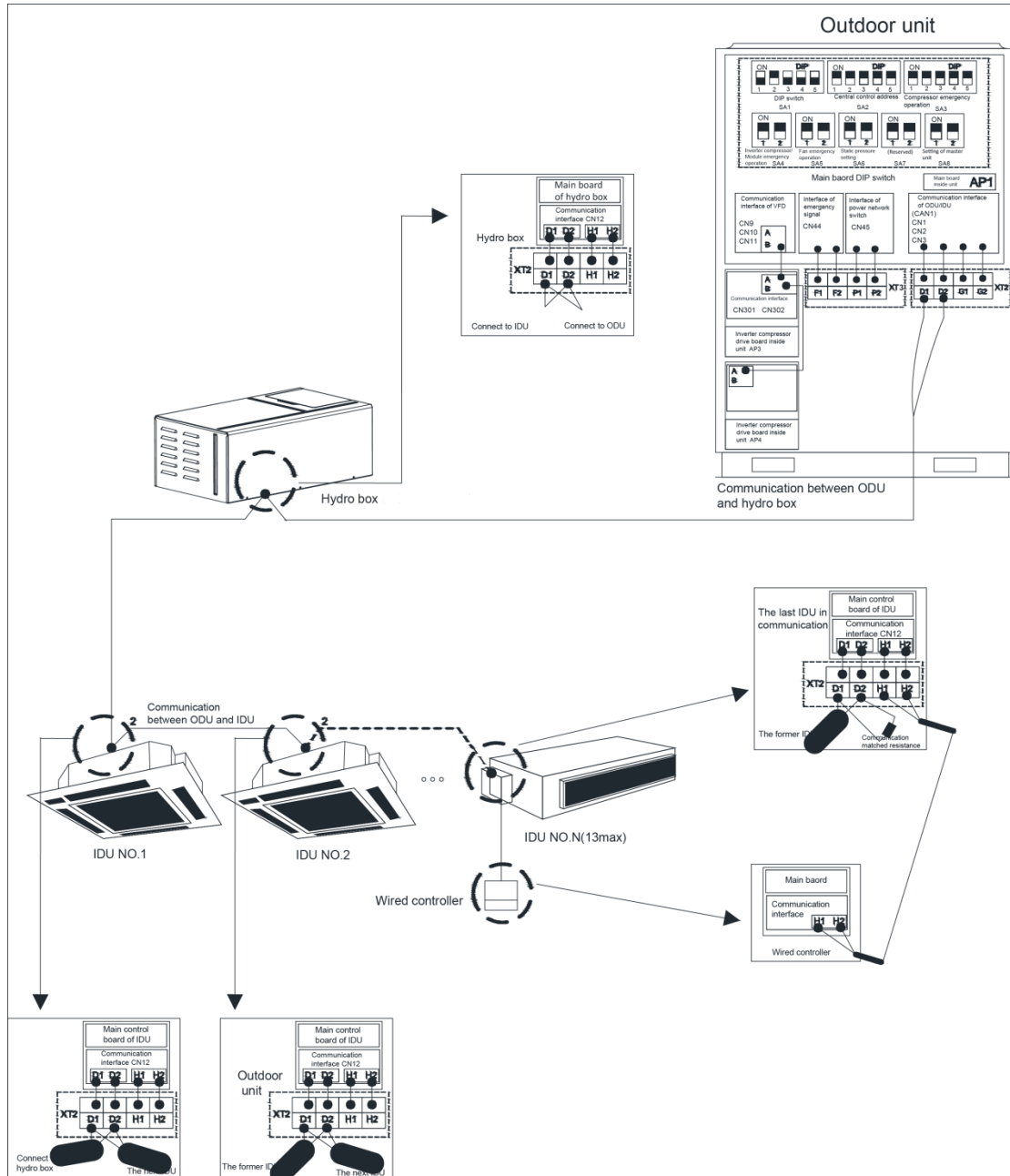

Note:

- ① The communication cable and power cable must be laid separately to avoid interference.
- ② The communication cable must be long enough to avoid joints.
- ③ Indoor units and hydro box must be connected in series. The last IDU shall be connected to a matching resistor (placed in the package of the ODU).

12.3.2 Communication connection between the IDU and wired controller

Connection modes for the communication cable between the IDU and wired controller are shown in the following figures:

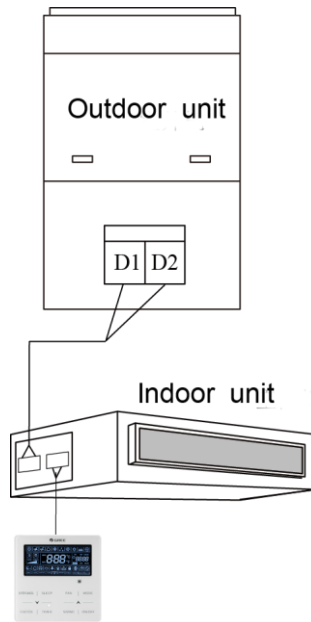

Figure 2 One wired controller controlling one IDU

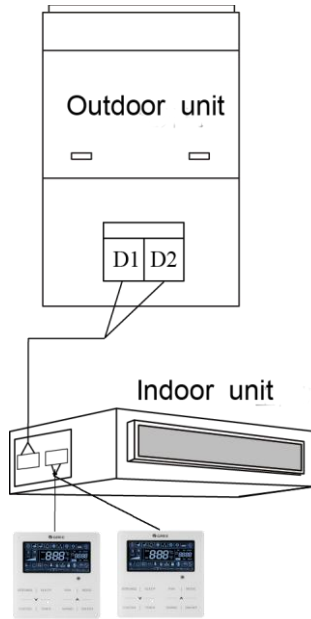

Figure 3 Two wired controllers controlling one IDU

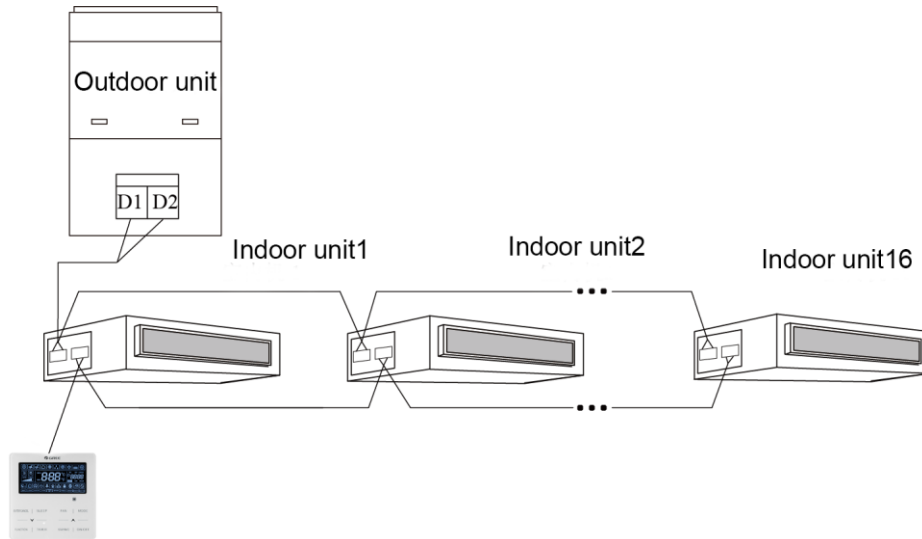

Figure 4 One wired controller controlling multiple IDUs

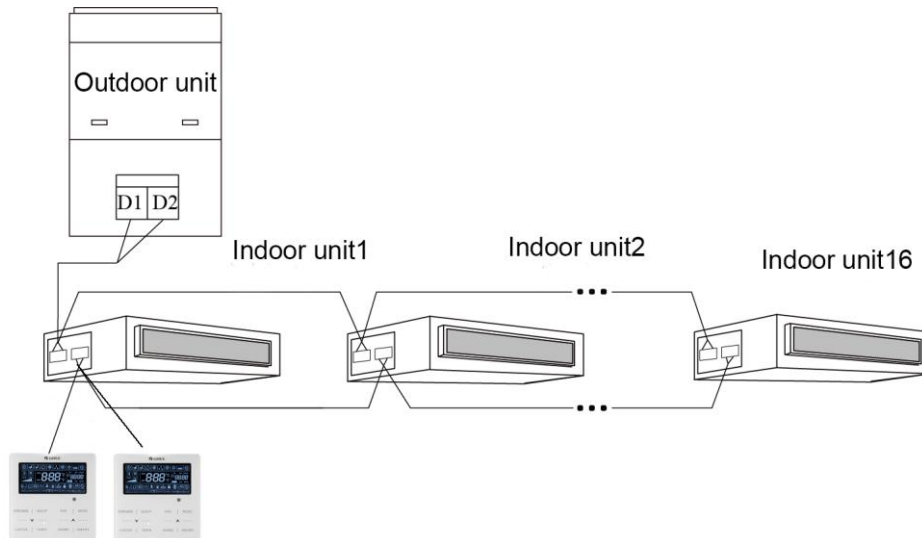

Figure 5 Two wired controllers controlling multiple IDUs

When two wired controllers control several indoor units, wired controllers can be connected with any one of the indoor units, which are required to be of the same series. One and only one of the two wired controllers shall be set as the secondary wired controller. The number of indoor units controlled by wired controller cannot exceed 16. All the connected indoor units must be in the same network.

- (1) The secondary wired controller can be set when unit is turned on or off.
- (2) Keep pressing “Function” button for 5 seconds on the wired controller that is to be set as the secondary wired controller. Temperature zone will display “C00”. Continue to press “Function” button for 5 seconds, and the parameter setting interface will be displayed. The temperature zone will then display “P00”.
- (3) Select code P13 by pressing “” or “”. Press “Mode” button to switch to parameter value setting. When the parameter value is flickering, select code “02” by pressing “” or “”. Then press “Enter/Cancel” button to finish setting.
- (4) Users can press “Enter/Cancel” button to return to a previous stage until parameter setting exits.

User parameter setting list is shown below:

Parameter code	Parameter name	Parameter range	Default value	Remarks
----------------	----------------	-----------------	---------------	---------

GMV5 Home DC Inverter Multi VRF Units

P13	Wired controller address setting	01: Primary wired controller 02: Secondary wired controller	01	When two wired controllers control one (or more) indoor units, the addresses of the controllers must be different. Secondary wired controller (address is 02) does not support unit's parameter setting except setting of its own address.
-----	----------------------------------	--	----	--



⚠ Note:

- a) All wired controllers are set as primary wired controller before leaving factory.
- b) Under the status of parameter setting, speed button, timer button, sleep button and swing button are all invalid. Pressing “On/Off” button will return to homepage but won’t turn on or off the unit.
- c) Under the status of parameter setting, remote control signal is invalid.

12.3.3 Communication connection between the hydro box and wired controller

There are four connection method as shown below

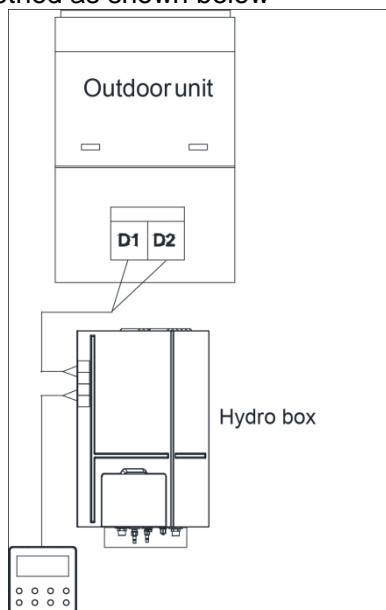

One wired controller controls one hydro box

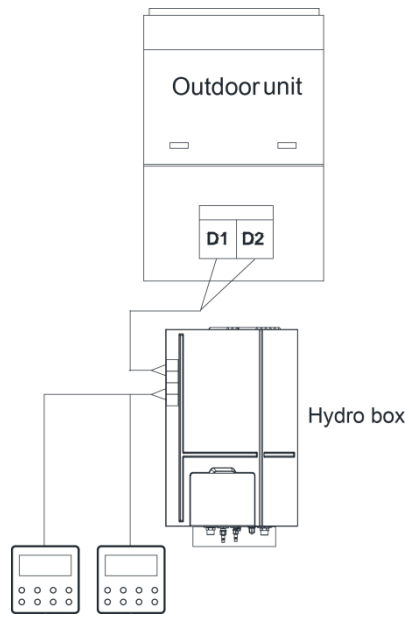

Two wired controllers control one hydro box

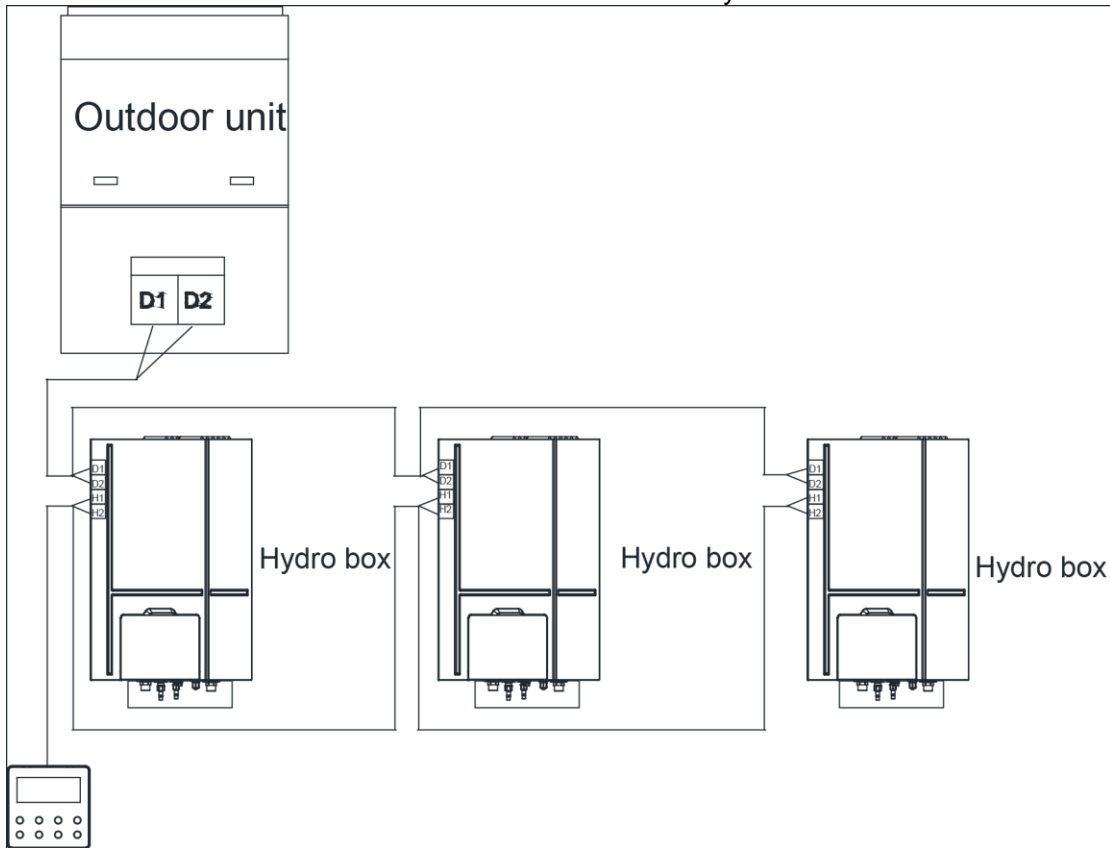

One wired controller controls multiple hydro boxes

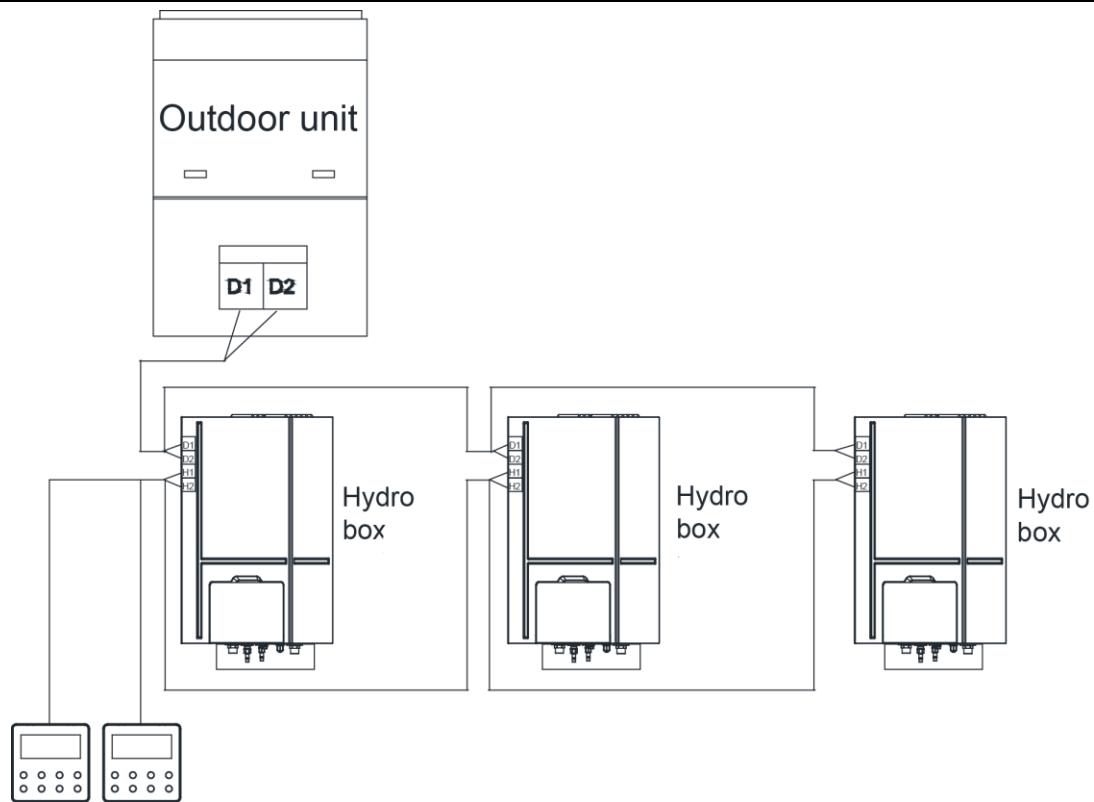

Two wired controllers control multiple hydro boxes

Wiring instructions:

- (1) When one wired controller controls several hydro boxes , the wired controller can connect to any one of the hydro boxes , but the devices connected to wired controller must be either hydro boxes . Up to 3 hydro boxes are connectable and the connected hydro boxes must be in a same network.
- (2) When two wired controllers control one hydro box at the same time, the wired controllers must have different addresses.
- (3) When two wired controllers control several hydro boxes , the wired controller can connect to any one of the hydro box, but the devices connected to wire controller must be either hydro boxes . Addresses of wired controllers must be different from each other. Up to 3 hydro boxes are connectable and the connected hydro boxes must be in a same network.
- (4) When one (or two) wired controller controls several or hydro boxes, the controlled hydro box must have the same setting.
- (5) Communication network between wired controller and hydro box must be connected according to one of the 4 connection methods stated above. If the connection includes two wired controllers, only one can be set as a master controller (addr 01) while the other as slave wired controller (addr 02). Only two wired controllers can be connected at most.

12.3.4 Connection between the duct type IDU and receiver board

When the duct type IDU needs to be connected to the remote-control receiver board, connect via Dsp1 and Dsp2 on the main board of the IDU:

Type of ndoor unit	Connection wire	Corresponding interface on mainboard
Duct type	Inter-board connection (17 cores)	Dsp1 (interconnecting with the 8-core interface) Dsp2 (interconnecting with the 9-core interface)

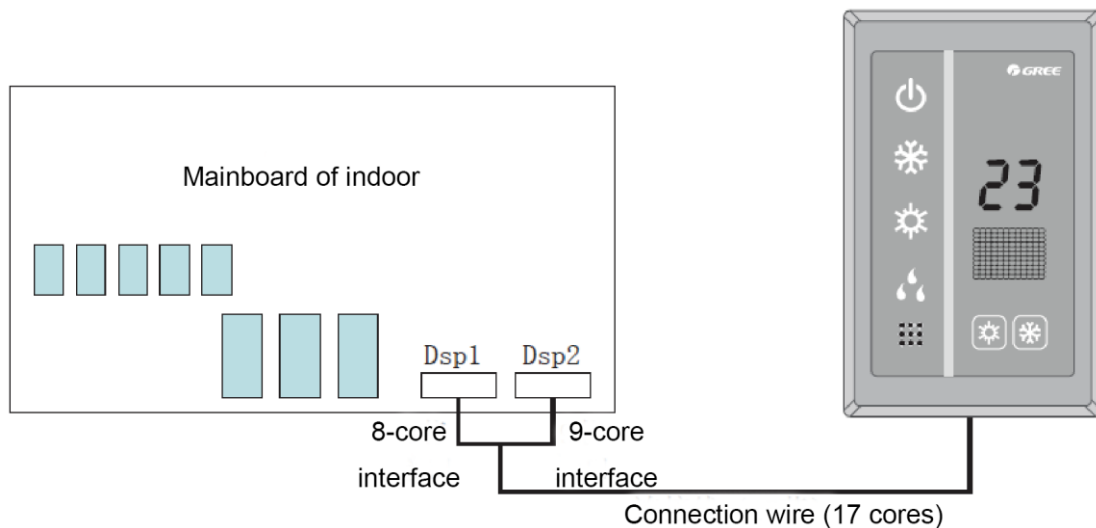

⚠ Note:

- a) Wired controller and remote-control receiver board can be used at the same time.
- b) If remote-control receiver board is selected, please select a remote controller.

13. Refrigerant Charging

13.1 Precautions on Refrigerant Leakage

Personnel related to air conditioning engineering design and installation operators must abide by the safety requirement for preventing refrigerant leakage specified in local laws and regulations. If such safety requirement is unavailable in local documents, the design and operation must be implemented based on the following principles: the system adopts the R410A refrigerant, which is nonflammable and nontoxic. However, the space for refrigerant leakage must be sufficient to ensure that the refrigerant concentration does not exceed that specified in the safety requirement; otherwise, people involved can be stifled by the refrigerant.

The maximum refrigerant charge and maximum refrigerant concentration in the system are calculated directly based on the size of the air conditioning space. The unit of refrigerant concentration is 1 kg/m^3 .

- 1) Flow direction of refrigerant leakage.
- 2) Room for refrigerant leakage. Since the concentration of refrigerant is greater than that of air, pay attention to the spaces where the refrigerant may residue, for example, the basement.

Method for calculating the maximum concentration of refrigerant:

- ① Calculate the refrigerant charge quantity of each system.

Charge quantity of an ODU upon delivery (for the system consisting of multiple modules in parallel, the accumulative charge quantity of modules upon delivery is used) + Onsite charge quantity = Total refrigerant charge quantity in the system (kg)

- ② Calculate the volume of minimum air conditioning space (m^3)

Volume of air conditioning space (m^3) = Length x Width x Height

Note: The length, width and height here refer to the effective length, width and height of the indoor space.

- ③ Calculate the maximum refrigerant concentration of the refrigeration system.

"Total refrigerant quantity of the system" / "the volume of minimum air conditioning space" \leq Maximum allowable concentration (kg/m^3)

Note: If the maximum allowable refrigerant concentration is not available in relevant local standard, use 0.3 kg/m^3 as the maximum allowable refrigerant concentration.

- ④ If the maximum refrigerant concentration exceeds the allowed threshold, the refrigeration system must be redesigned. In this case, separate the refrigeration system into multiple small-capacity refrigeration systems, or adopt other ventilation measures, or contact local Gree sales company.

13.2 Calculation of Additional Refrigerant Charge Amount

13.2.1 Constitution of additional refrigerant charge

Additional refrigerant charge amount = additional refrigerant charge of liquid pipe × additional refrigerant charge of hydro box + additional refrigerant charge of high pressure gas pipe

(1) Additional refrigerant charge of liquid pipe

Additional refrigerant charge of liquid pipe(kg)=∑length of liquid pipe × refrigerant charge amount of every meter of liquid pipe.

Refrigerant charge amount of every meter of liquid pipe(kg/m)							
φ28.6	φ25.4	φ22.2	φ19.05	φ15.9	φ12.7	φ9.52	φ6.35
0.680	0.520	0.350	0.250	0.170	0.110	0.054	0.022

!Note:

- ① Liquid pipe includes the liquid pipe which ODU connects IDU and the liquid pipe which ODU connects hydro box.
- ② For GMV-S120WL/A-S, GMV-S140WL/A-S, GMV-S160WL/A-S, if the total liquid pipe length is within 20m, no additional refrigerant charge is needed.

(2) Additional refrigerant charge of hydro box

Additional refrigerant charge of hydro box(kg)=0.3*quantity of hydro box

(3) Additional refrigerant charge of high pressure gas pipe

Additional refrigerant charge of high pressure gas pipe(kg)=∑length of high pressure pipe × refrigerant charge amount of every meter of high pressure pipe.

Refrigerant charge amount of every meter of high pressure pipe(kg/m)			
φ19.05	φ15.9	φ12.7	φ9.52
0.15	0.12	0.09	0.05

! Note: High pressure pipe includes the high pressure pipe which ODU connects hydro box.

13.2.2 Example of calculation

Top discharge GMV-S280W/A-X is taken for example (three sets of indoor unit GMV-NHD90PLS/ES are connected and two sets of hydro box NRQD16G/A-S are connected):

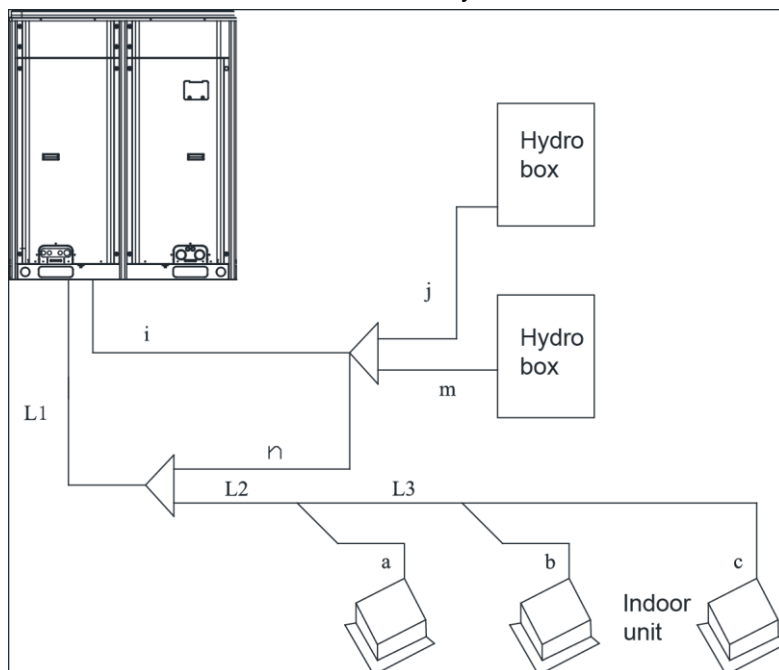

GMV5 Home DC Inverter Multi VRF Units

(1) Additional refrigerant charge of liquid pipe(kg) = Σ length of liquid pipe \times refrigerant charge amount of every meter of liquid pipe

No.	L1	L2	L3	a	b	c	n	m	j
Pipe diameter	ϕ 9.52	ϕ 9.52	ϕ 9.52	ϕ 9.52	ϕ 9.52	ϕ 9.52	ϕ 9.52	ϕ 9.52	ϕ 9.52
Length	10m	10m	5m	5m	5m	10m	5m	5m	8m
Additional charge amount	0.54	0.54	0.27	0.27	0.27	0.54	0.27	0.27	0.432

(2) Additional refrigerant charge of hydro box(kg)= $0.3 \times 2 = 0.6$ kg

(3) Additional refrigerant charge of high pressure gas pipe(kg)= Σ length of high pressure pipe \times refrigerant charge amount of every meter of high pressure pipe= 2.1 kg

No.	i	j	m
Pipe diameter	ϕ 15.9	ϕ 12.7	ϕ 12.7
Length	10m	5m	5m
Additional charge amount	1.2	0.45	0.45

(4) Total additional refrigerant charge amount(kg)= $3.402 + 0.6 + 2.1 = 6.102$ kg

Chapter 4 Commissioning Operation

1. Commissioning Flowchart

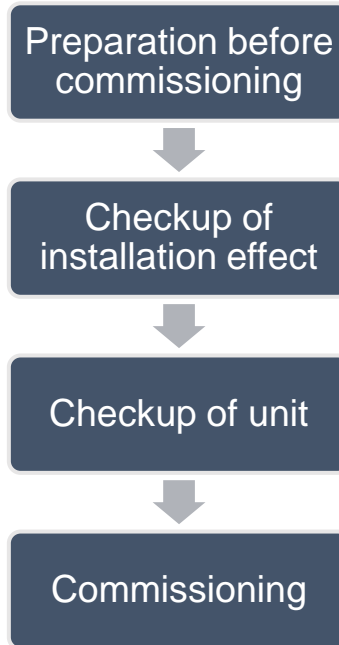

2. Safety Notices



Warning!

All commissioning and maintenance personnel must lean and strictly comply with construction security specifications. Security measures must be taken especially for outdoor operations;

Workers of special types of labor, such as refrigerating engineers, electricians, and welders, must have professional certificates. No worker is allowed to do another type of labor.

The equipment must be powered off before relevant operations, and other security requirements should be strictly complied with.

All installation and maintenance operations must comply with design requirements of this product and national and local security operation requirements. Rule-breaking operations are prohibited.

It is not allowed to force start the compressor with direct power supply.

3. Preparation before Commissioning

3.1 Preparation of Commissioning Tools

Inner hexagon spanner	Digital display temperature meter
Adjustable wrench	Noise meter
Phillips screwdriver	Clamp meter
Slotted screwdriver	Digital multimeter
Vacuum pump	Electric meter
Electronic scale	Time-meter
High and low pressure gauge for	Standing ladder

GMV5 Home DC Inverter Multi VRF Units

corresponding refrigerant system	
Wind velocity indicator

At present, there are two commissioning methods for unit, one is to operate directly via the button on mainboard of outdoor unit, another is to install special software and conduct commissioning via PC, the PC software can at the same time display parameter of indoor and outdoor units. (For specific operation please refer to corresponding instruction manual).

3.2 Preparation of Commissioning Papers

In order to record the situation of installation and commissioning of unit, the following commissioning documents should be completely prepared: programme confirmation meeting record sheet before commissioning, record sheet of commissioning personnel, check table before commissioning, commissioning data record sheet, commissioning report, etc.

Programme confirmation meeting record sheet:

Programme confirmation meeting for commissioning of *** engineering air conditioner
Subject: ***
Date: ***
Place: ***
Attendee: ***
Contents: ***
1
2
3

Commissioning data record sheet:

Project name:		Model:	
Conner:		Date:	
Model and quantity of outdoor unit	Model and quantity of hydro box	Model and quantity of water tank	
Rated capacity of outdoor unit (kW):	Total rated capacity of indoor unit (kW):	Total length of refrigerant pipe (m):	
Maximum height difference between indoor and outdoor units (m):	Height difference between hydro box and outdoor unit (m):	Adding quantity of refrigerant (kg):	
Commissioning status: <input type="checkbox"/> cooling <input type="checkbox"/> heating <input type="checkbox"/> water heating <input type="checkbox"/> floor heating Operating quantity and capacity of indoor unit: Operating quantity and capacity of hydro box:			
Status and Parameter	Unit	Before startup	30min 60min 90min

GMV5 Home DC Inverter Multi VRF Units

Status and parameter of outdoor unit	Outdoor ambient temperature	℃				
	Supply voltage	V				
	Frequency	Hz				
	Current of compressor	A				
	Exhaust temperature	℃				
	High pressure of system	℃				
	Low pressure of system	℃				
					
Parameter of 1# indoor unit	Rated capacity	KW				
	Ambient temperature	℃				
	Wind notch of indoor unit	Notch				
	Temperature of air outlet	℃				
	Wind speed in air outlet	M/S				
	Noise	dB				
	Drainage of water collecting tray	—				
Parameter of 2# indoor unit	Rated capacity	KW				
	Ambient temperature	℃				
	Wind notch of indoor unit	Notch				
	Temperature of air outlet	℃				
	Wind speed of air outlet	M/S				
	Noise	dB				
	Drainage of water collecting tray	—				
.....						
Parameter of hydro box	Rated capacity	KW				
	Water temperature in water tank	℃				

GMV5 Home DC Inverter Multi VRF Units

	Notch of water pump	Notch				
	Water-out temperature	°C				
	Water-in temperature	°C				
.....						

3.3 Inspection before Commissioning



Caution!

Check Table before Commissioning					
Type	No.	Item for checking	Reference	Pass or not	Checked by
Checkup of installation drawing	1	Check if the engineering design drawing is complete.			
	2	Check if the construction is conducted according to design drawing.			
Checkup of installation environment	3	Check if there is pollution source around installation place of outdoor unit, whether the selection of installation position of outdoor unit is correct.	Refer to installation of outdoor unit		
	4	Check if basement of outdoor unit is firm enough? Whether its damping and drainage comply with the requirement?	Refer to installation of outdoor unit		
	5	Check if the outdoor unit is operated with static pressure? Whether it has been set with corresponding static pressure?			
Checkup of cooling system	6	Check if the capacity of indoor unit accounts for 80%~100% of rated capacity of outdoor unit?	80%~100%		
	7	Check if pipeline of refrigerant and water pipe are in conformity with the requirements?	Refer to installation requirements		
	8	Check if the height difference between indoor unit and outdoor unit meet the design requirement of unit?	Height difference when outdoor unit is in upper position40m Height difference when outdoor unit is in lower		

GMV5 Home DC Inverter Multi VRF Units

			position50m		
9	Check if height difference among indoor units are in conformity with design requirement of unit?	15m			
10	Check if the length of pipeline between outdoor unit and the farthest indoor unit is less or equal to 120m?	120m			
11	Check if the total length of pipeline is less than 300m?	300m			
12	Check if the length from outdoor unit to the first branch pipe is larger than 90m? If it is, does the pipe diameter need to be enlarged?	when it is larger than 90m, the pipe diameter should be accordingly enlarged.			
13	Check if the distance between indoor unit to its nearest branch pipe is larger than 10m? If it is, does the pipe diameter need to be enlarged?	when it is larger than 10m, the pipe diameter should be accordingly enlarged.			
14	Inclination pitch of indoor and outdoor branch pipes should not be over the required ranged.	Install it horizontally, refer to installation of branch pipe.			
15	Check if all the cut-off valves of outdoor unit are opened as large as possible?				
16	Check if pressure of refrigerant is normal? Use high pressure gauge to connect to valve of liquid pipe of outdoor unit, and use low pressure gauge to connect to valve of air pipe of outdoor unit, and then read the numerical value respectively.	At this time, high pressure and low pressure of system is in an equal status, and the difference between saturation temperature and ambient temperature (take the higher one in indoor and outdoor temperature) should not be over 5C, otherwise please check if there is leakage in outdoor unit.			
17	Check if there is oil stain of refrigerant oil in valve? If there is,				

GMV5 Home DC Inverter Multi VRF Units

		use soapy water or leak detector to conduct leak detection. After it is checked to be leak, stop the subsequent commissioning immediately. Resume the commissioning work after the leaking problem is solved.			
	18	Before starting the commissioning, whether the outdoor unit has conducted preheating for over 8 hours?			
Checkup of electrical system	19	Check if connecting method of power cord is correct, if the wiring terminals are firm enough?			
	20	Check if appearance of power cord is in good condition without being exposed?	The appearance of power cord is in good condition without being exposed.		
	21	Check if capacity of power supply is less than maximum power of unit?	It should be larger than maximum power of unit.		
	22	Check if there is looseness in electrical components inside electric box under power-off status?	It is not allowed to be loose.		
	23	Check if wire diameter of indoor unit, outdoor unit, hydro box and water tank is in conformity with design requirement of unit?	Refer to electrical installation		
	24	Check if circuit breaker and electrical leakage switch have met the design requirements of unit	Refer to electrical installation		
	25	Check if supply voltate, phase sequence and frequency have met the requirement of unit?	It should be in conformity with name plate of unit, voltage fluctuation range should be within 10%		
	26	Check if the distance from power cord to TV set is over 1m?			
	27	Check if there is strong electromagnetic interference, dust or acid and alkali gas in surrounding of unit			
	28	Check if wire stock of communication wire is in conformity			

GMV5 Home DC Inverter Multi VRF Units

Checkup of communication system		with design requirement of unit?			
	29	Check if dial switch of outdoor unit is correct?			
	30	Check if communication between outdoor main control unit and indoor unit, outdoor control unit and hydro box are correct?	Tandem connection		
	31	Check if communication connection between indoor unit and hydro box is correct?			
	32	Check if communication connection between indoor unit and wired controller, hydro box and wired controller are correct?			
	33	Check if the last indoor unit with communication has been installed with matching resistance?			
	34	Communication wire should not be laid with power cord in the same slot, it should be independently laid with inflaming retarding hard PVC tube, and parallel distance between communication wire and strong electrical wire should be over 20cm.			
Checkup for installation of indoor unit	35	Check if degree of slope of drain pipe of indoor unit is 1/100?			
	36	Check if increased height of drain pipe of indoor unit is less than 85cm?			
	37	Check if drainage of indoor unit is smooth?			
	38	Check if there is U-shape water storage elbow in drain pipe of indoor unit?			
	39	Check if there is soft connection in air outlet and air returning inlet of indoor unit? If there is static pressure box in air returning inlet?			
	40	Check if there is drain outlet of water pipe in indoor unit?			
	41	Check if wired controller or panel of main indoor unit have been stuck with the mark of main?			
Checkup for	42	Check if hydro box is installed indoors?	Indoor location		

GMV5 Home DC Inverter Multi VRF Units

installation of hydro box	43	Check if hydro box is installed in the location with ambient temperature of over 4C	It should be installed in the location with ambient temperature of over 4C.		
	44	Check if the hydro box is installed in rainproof position	It should be rainproof.		
	45	Check if installation of water tank is firm.	It should be firm.		
	46	Check if model of hydro box and water tank is correctly matched.	Refer to requirement of model selection		
	47	Check if quantity of hydro box is in conformity with the requirement?	Refer to requirement of model selection		
	48	Check if connecting quantity of water tank is in conformity with the requirement?	Refer to requirement of model selection		
	49	Check if S2 dial switch in mainboard of hydro box is in conformity with actual situation of connecting equipment?	Refer to dial switch instruction of hydro box.		
	50	After the hydro box is connected to floor heating , calculate if there is water power loss? If there has installed engineering water pump?	Refer to actual situation and instruction manual, generally if delivery lift is over 6m, it should install a floor heating engineering water pump.		
	51	When the hydro box is connected to water tank or floor heating, whether C valve and D valve have been installed in water system? Whether the C valve and D valve is straight-through type with small resistance?	There should install C valve and D valve with straight-through type with small resistance.		
	52	Check if C valve, D valve and floor heating performer are normally closed?	Normally closed		
	53	Check if water cycle has been conducted heat insulation protection?	Refer to installation manual.		
	54	Whether there is reducing valve	It should install		

		when water replenishing pressure is over 3 bar?	reducing valve in water system.		
	55	Check if floor heating performer of each room has been connected to hydro box? If it has conducted linkage setting with indoor unit?	Refer to installation setting of hydro box		
	56	Check if auto emptier is installed in floor heating water cycle and hot water cycle?	Refer to installation instruction of hydro box.		
	57	Check if hydro box is installed in the first branch pipe?	It should be installed in the forefront of branch pipe.		

4. Commissioning Operation

Note: An indoor unit must be set to be master indoor unit and only one can be set during commissioning.

If there is no special requirement, there's no need to set other functions and you can operate the unit in factory settings. If special functions are needed, please refer to relevant section in this manual.

4.1 Commissioning Operation of Hydro Box

4.1.1 Confirm Main Board DIP Switch

Confirm the DIP switch S_1 and S_2 on the main board of hydro box. S_1 is capacity DIP switch while S_2 is function DIP switch.

4.1.1.1 Capacity DIP Switch of Hydro Box (S1)

Capacity DIP switch S_1 has 5 digits. No not alter it arbitrarily.

Capacity of hydro box	Capacity DIP switch				Model DIP switch
	1	2	3	4	5
16	ON	OFF	OFF	ON	OFF

Note:

DIP switch must be set in place. Never set the switch in a middle position. "ON" indicates "0" status while the opposite direction indicates "1" status.

Example: S_1 is as below:

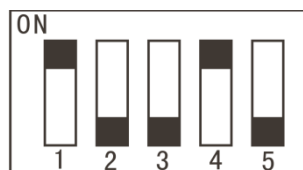

The black part indicates the lever.

4.1.1.2 Function DIP Switch of Hydro Box (S2)

Note: Please set in strict accordance with actual engineering condition.

Function DIP switch S2 has 4 digits, which are "1", "2", "3" and "4", indicating "Gree water tank", "floor heating", "solar power", "Self-made water tank" respectively. Each function can be set according to this rule: Moving lever to "number" means "Connect" and moving lever to "ON" means "Not connect". Digit "1" and "2" must be set based on actual engineering condition. Digit "3" and "4" cannot be changed arbitrarily, otherwise unit will have temperature sensor malfunction or fails to run.

Number of DIP switch	Meaning	DIP switch		Factory setting
		Not connect	Connect	
1	Gree water tank	ON	OFF	OFF
2	Floor heating	ON	OFF	OFF
3	Solar power	ON	OFF	ON
4	Self-made water tank	ON	OFF	ON

Example: S2 is as below:

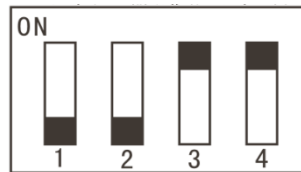

Note: The black part indicates the lever.

4.1.2 Commissioning Operation

4.1.2.1 Preparation for Commissioning

- (1) Check if unit is correctly installed.
- (2) Check if the pipeline of water system and wires of electrical system are connected properly.
- (3) Check if the circulating water pipe adopts thermal insulation.
- (4) Check if ground wire is connected.
- (5) Check if the voltage is unit's rated voltage.
- (6) Check if the check valves and relief valves of water inlet and water outlet are correctly installed.
- (7) Check if the pipeline of water system is evacuated and check if the air outlet valve and blow down valve are closed.
- (8) Water inlet pressure must be above 0.15MPa.

4.1.2.2 Water System Commissioning (Leak Detection and Evacuation)

4.1.2.2.1 Leak Detection

After the pipeline of water system is connected, perform leak detection. After confirming that there is no leak, adopt thermal insulation to the pipeline of water system. Pay attention that the valves and pipe joints also need thermal insulation. We recommend you to use thermal insulation cotton that is more than 15mm's thick.

4.1.2.2.2 Water Filling and Air Discharge between Hydro Box and Water Tank and Floor Heating Pipe

(1) Make sure that each pipe of water system is well connected. Close the air outlet valve that connects with hydro box in exit pipe engineering construction and make sure that the blow down valve is closed completely.

(2) Open the water replenishing valve and fill water in. open the air outlet valve that is connected in engineering construction.

(3) When there is water coming out from the air outlet valve, open the manual air outlet valve A.

(4) When water flows out from air outlet valve A, energize the hydro box and turn on cleaning mode to start evacuation. The operation method is: Under OFF status of hydro box, press and hold "WATER/AC/FLOOR" for 5s and then "Clean" is lit up.



(5) After running for 15~20 minutes, observe the air outlet valve that connects with hydro box during exit pipe engineering construction. When water is flowing out steadily with no air flow, it means evacuation is completed. Then you can close the manual air outlet valve A and stop the hydro box. The operation method is: Press and hold "WATER/AC/FLOOR" for 5s and hydro box will stop cleaning. "Clean" goes off.



4.1.2.2.3 Evacuation of Water Tank and User Side Pipeline

(1) Make sure each pipe joint of water tank is well connected and the blow down valve of water tank is closed completely.

(2) Open the water replenishing valve of water tank and the water valve at user side. Fill water into the tank until there is water coming out from the water valve at user side without any air flow. Then water tank has finished water filling and evacuation. Close the water valve at user side and go on with commissioning of the entire unit.

4.1.2.2.4 Re-evacuation

After all the wires of indoor units, outdoor unit and hydro box are connected and the commissioning of fluorine system is finished, perform evacuation again. Following is the operation procedure:

(1) Open the hot water tap and water replenishing valve of water tank to fill water inside until water temperature reaches 20~30°C.

(2) Turn on water heating mode and open manual air outlet valve A in the meantime.

(3) After 15~20 minutes of operation, if the temperature difference between entering water temperature and leaving water temperature of hydro box is smaller than 10°C, it means evacuation is completed. Then you can close the manual air outlet valve A and stop the hydro box.

Evacuation of water system is done.

(4) Above operation procedure must be done on the condition that water tank water temperature is lower than 45°C. If temperature difference of hydro box cannot satisfy the required value when water tank temperature reaches 45°C, turn off the unit. Then open the hot water tap and fill hot water into the water tank through the water replenishing valve until water temperature reaches 20~30°C. After that, turn on heating mode and open manual air outlet valve A again to perform evacuation.



Warning: Water pump is set to  before ex factory. Never try to change the setting, otherwise, water pump will get damaged and unit will have malfunction.

4.1.3 Settings of Floor Heating Performer and Indoor Unit

Please refer to the previous section.

4.1.4 Capacity Setting of Water Tank

Please refer to the previous section.

4.1.5 Test Operation

Test operation of hydro box should be conducted simultaneously with test operation of outdoor unit. Please refer to the following section about commissioning of the entire unit.

4.2 Commissioning Operation of the Entire Unit

4.2.1 Preparation for Test Operation

- 1) Power can be turned on only after all installation work is finished.
- 2) All control circuits, electric wires are connected correctly and securely. Gas pipe valve and liquid pipe valve are open completely.
- 3) All fragmental objects, such as metal scrap, wire stub and clamp, should be removed from the unit.
- 4) Check if the surface and pipes of unit are damaged during transportation or carrying.
- 5) Check if the wiring terminals of electric components are loosened or not. Check if the phase sequence is correct.
- 6) Check the opening and closing status of valves. After outdoor unit is connected with hydro box, three valves (gas valve, liquid valve, high pressure gas valve) of the outdoor unit must be open.

4.2.2 Test Operation

4.2.2.1 Precautions

(1) Before starting commissioning, make sure that the compressor has been preheated for more than 8 hours and check whether preheating is normal by touching. Commissioning can be started only when preheating is normal. Otherwise, compressor may be damaged. Commissioning must be performed or guided by professional personnel.

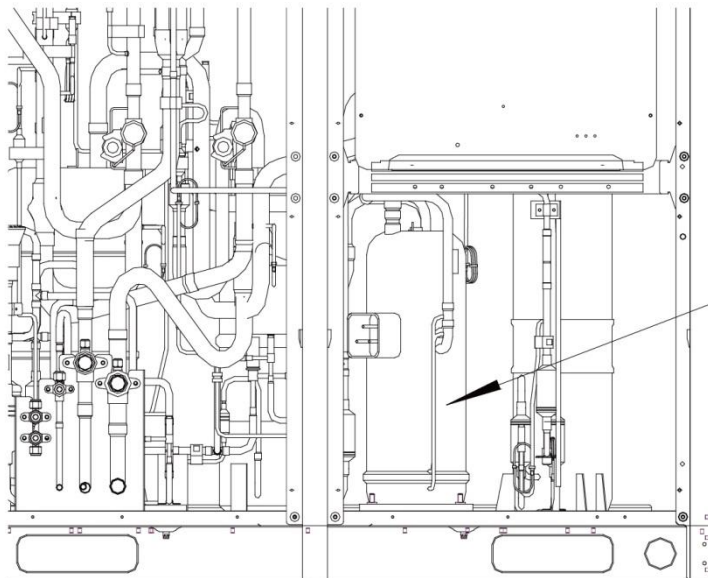

Make sure the compressor has been preheated for more than 8 hours.

Make sure the compressor has been preheated for more than 8 hours.

(2) When unit commissioning is started, the system automatically selected an operation mode according to the environment temperature.

a. When outdoor temperature is higher than 20°C, commissioning should be in cooling mode and water heating mode.

b. When outdoor temperature is lower than 20°C, commissioning should be in heating mode and water heating mode.

Note: If system is not connected with water tank or the water heating function of hydro box is wrongly set, unit will not run in water heating mode.

(3)、 Before starting commissioning, make sure again that stop valves of all basic modules of the outdoor unit have been completely opened.

(4)、 During commissioning, the front panel of outdoor unit must be completely covered. Otherwise, commissioning accuracy may be affected (as shown in the following figure).

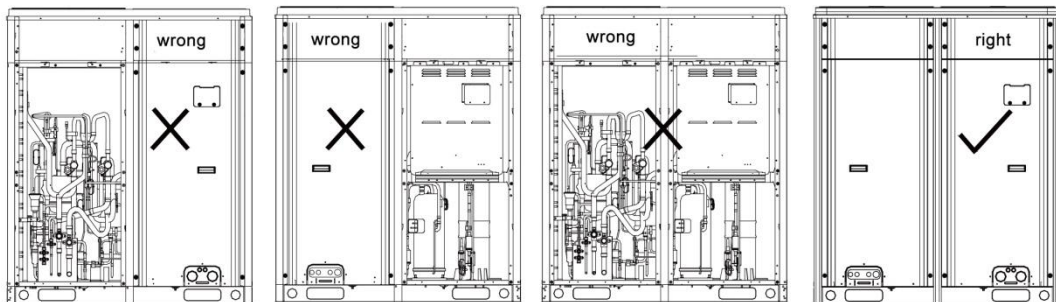

(5)、 Before commissioning, make sure that additional refrigerant to pipes has been finished completely or for more than 70%.

(6)、 The following table describes progress display of each phase during commissioning:

Progress Description for Commissioning Phases							
—	Commissioning code		Progress code		Status code		Meaning
Progress	LED1		LED2		LED3		
	Code	Display status	Code	Display status	Code	Display status	
01_Master unit setting	db	ON	01	ON	A0	ON	System is in non-commissioning

GMV5 Home DC Inverter Multi VRF Units

							status.
	db	ON	01	ON	OC	ON	System has set a master unit and automatically enters the next step.
02_Unit address distribution	db	ON	02	ON	Ad	Blinking	System is assigning addresses.
	db	ON	02	ON	L7	Blinking	There is no master indoor unit. Please set master indoor unit. If no master indoor unit is set within 1 minute, system will automatically set one.
	db	ON	02	ON	OC	ON	System has finished address distribution and automatically enters the next step.
03_Basic module quantity confirmation	db	ON	03	ON	0104	Blinking	LED3 displays the quantity of outdoor unit. Confirm manually if the quantity is 01.
	db	ON	03	ON	OC	ON	System has confirmed the quantity of outdoor unit and automatically enters the next step.
04_Indoor unit quantity confirmation	db	ON	04	ON	0180	Blinking	LED3 displays the quantity of indoor unit. Confirm manually if the quantity of indoor unit is correct.
	db	ON	04	ON	OC	ON	System has confirmed the quantity of indoor unit and automatically enters the next step.
05_Internal communication detection	db	ON	05	ON	C2	ON	System detects communication failure between master unit and inverter compressor drive.
	db	ON	05	ON	C3	ON	System detects communication failure between master unit and variable frequency fan drive.
	db	ON	05	ON	CH	ON	"Rated capacity ratio is over-high" between indoor units and outdoor unit
	db	ON	05	ON	CL	ON	"Rated capacity ratio is over-low" between indoor units and outdoor unit
	db	ON	05	ON	OC	ON	System has completed detection and automatically enters the next step.
Progress Description for Commissioning Phases							
	Commissioning code		Progress code		Status code		Meaning
Progress	LED1		LED2		LED3		
	Code	Display status	Code	Display status	Code	Display status	

GMV5 Home DC Inverter Multi VRF Units

06_ Component detection for outdoor unit	db	ON	06	ON	Corresponding error code	ON	System detects component failure of outdoor unit.
	db	ON	06	ON	OC	ON	System detects that no outdoor unit component fails and automatically enters the next step.
07_ Component detection for indoor units	db	ON	07	ON	Corresponding error code	ON	System detects component failure of indoor unit. XXXX means the project number of faulty indoor unit. 3s later, the corresponding error code will be displayed. For instance, if no.100 indoor unit has d5 error, then LED3 will display circularly as below: 01(2s later), 00(2s later), d5.
	db	ON	07	ON	OC	ON	System detects that no indoor unit component fails and automatically enters the next step.
08_ Compressor preheating confirmation	db	ON	08	ON	U0	ON	System gives a prompt if the preheat time for compressor is less than 8 hours.
	db	ON	08	ON	OC	ON	System detects that the compressor preheating time is more than 8 hours and automatically enters the next step.
09_Refrigerant detection before startup	db	ON	09	ON	U4	ON	System detects insufficient refrigerant and stops to balance the pressure lower than 0.3Mpa.
	db	ON	09	ON	OC	ON	System detects that refrigerant is normal and automatically enters the next step.
10_Outdoor unit valves detection before startup	db	ON	10	ON	ON	ON	Outdoor unit valves are being inspected.
	db	ON	10	ON	U6	ON	Outdoor unit valves are not fully opened.
	db	ON	10	ON	OC	ON	Outdoor unit valves are opened properly.
11_Calculate refrigerant charging amount manually	db	ON	11	ON	AE	ON	The refrigerant charging status is that charging amount of refrigerant shall be calculated manually (additional refrigerant must be accurately calculated).
12_ Unit commissioning startup confirmation	db	ON	12	ON	AP	Blinking	System waits for a unit commissioning startup command.
	db	ON	12	ON	AE	ON	The unit has been set to

GMV5 Home DC Inverter Multi VRF Units

							commissioning operation status of manual calculation of refrigerant charging amount
13_							No meaning.
14_							No meaning.
15_ Commissioning in cooling and water heating	db	ON	15	ON	AC	ON	System is in cooling-mode commissioning operation (system automatically selects the commissioning operation mode with no need of manual setting).
	db	ON	15	ON	11	ON	System is in water-heating-mode commissioning operation (System automatically selects the commissioning operation mode with no need of manual setting).
	db	ON	15	ON	Corresponding error code	ON	Malfunction occurs during cooling-mode commissioning operation.
	db	ON	15	ON	U9	ON	Malfunction occurs to outdoor unit pipes or valves.
	db	ON	15	ON	U8	ON	System detects pipe failure of indoor unit. XXXX means the project number of faulty indoor unit. 3s later, U8 will be displayed. For instance, if no.100 indoor unit has U8 error, then LED3 will display circularly as below: 01(2s later), 00(2s later), U8.
16_ Commissioning in heating and water heating	db	ON	16	ON	AH	ON	System is in heating-mode commissioning operation (system automatically selects the commissioning operation mode with no need of manual setting).
	db	ON	16	ON	11	ON	System is in water-heating-mode commissioning operation (System automatically selects the commissioning operation mode with no need of manual setting).
	db	ON	16	ON	Corresponding error code	ON	Malfunction occurs during heating-mode commissioning operation.
	db	ON	16	ON	U9	ON	Malfunction occurs to outdoor unit pipes or valves.

GMV5 Home DC Inverter Multi VRF Units

	db	ON	16	ON	U8	ON	System detects pipe failure of indoor unit. XXXX means the project number of faulty indoor unit. 3s later, U8 will be displayed. For instance, if no.100 indoor unit has U8 error, then LED3 will display circularly as below: 01(2s later), 00(2s later), U8.
17_ Commissioning completed	01~04	ON	OF	ON	OF	ON	The unit has completed commissioning and in standby status. LED1 displays module address. LED2 and LED3 display "OF".

4.2.2.2 Commissioning Operation Mode

There are two commissioning modes for the unit. One is to perform commissioning directly through the main board of outdoor unit. The other is to perform commissioning on a PC through special software. Parameters of outdoor units and outdoor unit can be simultaneously displayed and historical data can be stored and queried with the second method. (For details about the two methods, please refer to relevant instructions.)

Commissioning through the main board of outdoor unit:

Basic operation	Operation method	Remarks
Start of commissioning	Press and hold SW7 button on master control unit for more than 5 seconds.	
Selection of commissioning operation mode without wired controller	After the unit has started commissioning, press SW4 button and SW5 button simultaneously under any commissioning phase.	After entering this mode, system will no longer detect the communication status between indoor unit and wired controller. Indoor units can proceed with commissioning without wired controller.
Exit of commissioning	After the unit has started commissioning, press and hold SW7 button on master control unit for more than 5 seconds to quit commissioning.	
Pause of commissioning	After the unit has started commissioning, short press SW6 back button on master control unit to interrupt commissioning. Then system will stay in the last completed progress of the current commissioning phase.	This function is available after the 9 th step. For example, when system receives commissioning pause signal during the 10 th step 10_Outdoor unit valves detection before startup, it will return to the completion status of the 9 th step 9_Refrigerant detection before startup.
Continue of commissioning	When commissioning is paused, short press SW6 back button on master control unit again to continue commissioning.	

When commissioning is performed through the main board of outdoor unit, the main board provides the following commissioning functions:

Step 1: Cover the front panel of outdoor unit completely and open the commissioning window of outdoor unit.

Step 2: Under power-off status of outdoor unit, set up corresponding static pressure mode for

the outdoor unit according to static pressure design requirements for outdoor engineering. For details about the setting method, please see the “Outdoor Fan Static Pressre Setting DIP Switch (SA6_ESP_S)” section.

Step 3: Under power-off status of outdoor unit, set one module to be a master control unit. For details about the setting method, please see the “Master Unit Setting DIP Switch SA_MASTER-S” section. Note: This model is a single-module system and program will default it as the master unit. There is no need to set master unit.

Step 4: Power on outdoor unit and all the indoor units. Make sure all indoor units are powered on. Then outdoor unit will display “non-commissioning status”.

Step 5: Find the module with “01” address, which is the master control unit. On the master control unit, press and hold SW7 button for more than 5 seconds to enter commissioning.

Step 6: Wait for the unit to automatically start commissioning progresses 01 and 02.

Because this model is a single-module system and program defaults it as a master unit, there is no need to set master control unit. Digital tube of master control unit will display as below:

Progress	Commissioning code		Progress code		Status code		Meaning
	LED1		LED2		LED3		
	Code	Display status	Code	Display status	Code	Display status	
01_Master unit setting	db	ON	01	ON	OC	ON	System has set a master unit and automatically enters the next step.

After the above status is maintained for 2 seconds, system will enter address distribution automatically.

In progress 02, if master indoor unit is not detected, then the corresponding error will be displayed:

Progress	LED1		LED2		LED3	
	Function code	Display mode	Current progress	Display mode	Current status	Display mode
02_Unit address distribution	db	ON	02	ON	L7	Blinking

At this time, all buttons are invalid. You can set master indoor unit through the commissioning software within 1 minute. If master indoor unit is not set in 1 minute, system will set up a master indoor unit automatically. Then the system will automatically enters the next step.

Step 7: When the unit runs to progress 03, the quantity of outdoor modules needs to be confirmed manually. Outdoor unit will display as follows:

Progress	Commissioning code		Progress code		Status code	
	LED1		LED2		LED3	
	Code	Display status	Code	Display status	Code	Display status
03_Basic module quantity confirmation	db	ON	03	ON	Quantity of modules	Blinking

Note: LED3 code indicates the quantity of outdoor unit and it displays “01” in this case, which means there is only one outdoor unit.

If it displays “01”, press SW7 on master unit to confirm it. Then the unit will automatically enter progress 04:

Progress	Commissioning code		Progress code		Status code	
	LED1		LED2		LED3	
	Code	Display status	Code	Display status	Code	Display status

GMV5 Home DC Inverter Multi VRF Units

03_ Basic module quantity confirmation	db	ON	03	ON	OC	ON
--	----	----	----	----	----	----

If the quantity displayed is different from the number of actually connected modules, disconnect power and check whether communication wires are connected between outdoor modules. Single-module system cannot have communication connection with other outdoor units. After the check, start commissioning again.

Step 8: When the unit runs to progress 04, the quantity of indoor unit needs to be confirmed manually. Main board of each module will display as follows:

	Commissioning code		Progress code		Status code	
Progress	LED1		LED2		LED3	
	Code	Display status	Code	Display status	Code	Display status
04_ Indoor unit quantity confirmation	db	ON	04	ON	Quantity of connected indoor units	Blinking

If the quantity displayed is the same with the number of actually connected units, press SW7 on the master unit to confirm it. The unit will automatically starts the next commissioning progress:

	Commissioning code		Progress code		Status code	
Progress	LED1		LED2		LED3	
	Code	Display status	Code	Display status	Code	Display status
04_ Indoor unit quantity confirmation	db	ON	04	ON	OC	ON

Step 9: Progress 05 is "Internal communication detection".

If no error is detected, system will display as follows and then enter the next progress.

	Commissioning code		Progress code		Status code		Meaning
Progress	LED1		LED2		LED3		
	Code	Display status	Code	Display status	Code	Display status	
05_ Internal communication detection	db	ON	05	ON	OC	ON	System has completed detection and automatically enters the next step.

If error is detected, system will stay at current status and wait for manual troubleshooting.

Corresponding error codes include:

	Commissioning code		Progress code		Status code		Meaning
Progress	LED1		LED2		LED3		
	Code	Display status	Code	Display status	Code	Display status	

05_ Internal communication detection	db	ON	05	ON	C2	ON	System detects communication failure between master unit and inverter compressor drive.
--------------------------------------	----	----	----	----	----	----	---

GMV5 Home DC Inverter Multi VRF Units

	db	ON	05	ON	C3	ON	System detects communication failure between master unit and variable frequency fan drive.
	db	ON	05	ON	CH	ON	"Rated capacity ratio is over-high" between indoor units and outdoor unit
	db	ON	05	ON	CL	ON	"Rated capacity ratio is over-low" between indoor units and outdoor unit.

For details about the above troubleshooting method, please refer to "Troubleshooting Method" Part.

Step 10: Progress 06 is Component detection for outdoor unit.

If no error is detected, system will display as follows and then enter the next progress.

	Commissioning code		Progress code		Status code		Meaning
Progress	LED1		LED2		LED3		
	Code	Display status	Code	Display status	Code	Display status	
06_ Component detection for outdoor unit	db	ON	06	ON	OC	ON	System detects that no outdoor unit component fails and automatically enters the next step.

If error is detected, system will stay at current status and wait for manual troubleshooting. Corresponding error codes include:

	Commissioning code		Progress code		Status code		Error name
Progress	LED1		LED2		LED3		
	Function code	Display status	Current progress	Display status	Current status	Display mode	
06_ Component detection for outdoor unit	db	ON	06	ON	Corresponding error code	ON	System detects component failure of outdoor unit.

For details about the above troubleshooting method, please refer to Troubleshooting Method Part.

Step 11: Progress 07 is Component detection for indoor units.

If no error is detected, system will display as follows and then enter the next progress.

	Commissioning code		Progress code		Status code		Meaning
Progress	LED1		LED2		LED3		
	Code	Display status	Code	Display status	Code	Display status	
07_ Component detection for indoor units	db	ON	07	ON	OC	ON	System detects that no indoor unit component fails and automatically enters the next step.

If error is detected, system will stay at current status and wait for manual troubleshooting.

GMV5 Home DC Inverter Multi VRF Units

Corresponding error codes include:

	Commissioning code		Progress code		Status code		Error name
Progress	LED1		LED2		LED3		
	Function code	Display status	Current progress	Display status	Current status	Display mode	
07_Component detection for indoor units	db	ON	07	ON	XXXX/Corresponding error code	ON	System detects component failure of indoor unit.

XXXX means the project number of faulty indoor unit. 3s later, the corresponding error code will be displayed. For instance, if no.100 indoor unit has d5 error, then LED3 will display circularly as below: 01(2s later), 00(2s later), d5.

For details about the above troubleshooting method, please refer to “Troubleshooting Method” Part.

Step 12: Progress 08 is “Compressor preheating confirmation”.

If it is detected that compressor has been preheated for more than 8 hours, system will display as follows and then enter the next progress.

	Commissioning code		Progress code		Status code		Meaning
Progress	LED1		LED2		LED3		
	Code	Display status	Code	Display status	Code	Display status	
08_ Compressor preheating confirmation	db	ON	08	ON	OC	ON	System detects that the compressor preheating time is more than 8 hours and automatically enters the next step.

If it is detected that the compressor has not been preheated for more than 8 hours, system will give error alarm and display as follows. If compressor has been preheated for more than 2 hours, you can press SW7 button to skip the waiting time and system will automatically enter the next progress. However, this will cause forcible start of the compressor, which may get it damaged.

	Commissioning code		Progress code		Status code		Meaning
Progress	LED1		LED2		LED3		
	Code	Display status	Code	Display status	Code	Display status	
08_ Compressor preheating confirmation	db	ON	08	ON	U0	ON	System gives a prompt if the preheat time for compressor is less than 8 hours.

Step 13: Progress 09 is Refrigerant detection before startup.

If the refrigerant quantity inside the system meets the operation startup requirements, system will display as follows and then automatically enter the next progress.

	Commissioning code		Progress code		Status code		Meaning
Progress	LED1		LED2		LED3		
	Code	Display status	Code	Display status	Code	Display status	
09_Refrigerant detection before	db	ON	09	ON	0C	ON	System detects that refrigerant is normal and automatically enters

GMV5 Home DC Inverter Multi VRF Units

startup							the next step.
---------	--	--	--	--	--	--	----------------

If there is no or not enough refrigerant inside the system to meet the operation startup requirements, system will display U4 Refrigerant shortage protection and fail to continue with the next progress. In this case, check for leakage or add refrigerant until error disappears.

Progress	Commissioning code		Progress code		Status code		Meaning
	LED1		LED2		LED3		
	Code	Display status	Code	Display status	Code	Display status	
09_Refrigerant detection before startup	db	ON	09	ON	U4	ON	System detects insufficient refrigerant and stops to balance the pressure lower than 0.3Mpa.

Step 14: Progress 10 is Outdoor unit valves detection before startup.

If master unit displays as follows, it means valves detection is being started.

Progress	Commissioning code		Progress code		Status code		Meaning
	LED1		LED2		LED3		
	Code	Display status	Code	Display status	Code	Display status	
10_ Outdoor unit valves detection before startup	db	ON	10	ON	ON	ON	Outdoor unit valves are being inspected.

If the unit detects that valve status is not normal, it will display as follows:

Progress	Commissioning code		Progress code		Status code		Meaning
	LED1		LED2		LED3		
	Code	Display status	Code	Display status	Code	Display status	
10_ Outdoor unit valves detection before startup	db	ON	10	ON	U6	ON	Outdoor unit valves are not fully opened.

In this case, check the big and small valves whether they are fully opened or not. After the check, press SW6 to return to the previous step and restart valves detection.

If it is detected that valve status is normal, system will display as follows and automatically enter the next progress.

Progress	Commissioning code		Progress code		Status code		Meaning
	LED1		LED2		LED3		
	Code	Display status	Code	Display status	Code	Display status	
10_ Outdoor unit valves detection before startup	db	ON	10	ON	OC	ON	Outdoor unit valves are opened properly.

GMV5 Home DC Inverter Multi VRF Units

Step 15: Progress 11 is Calculate refrigerant charging amount manually.

There is no need to operate. System gives a prompt and then automatically enters the next progress.

Step 16: Progress 12 is Unit commissioning startup confirmation.

In order to make sure that all preparations are done before starting up the unit, it is required to confirm again whether to start the unit or not. Operation is as below:

If master unit displays as follows, it means the unit is waiting for confirmation signal.

Progress	Commissioning code		Progress code		Status code		Meaning
	LED1		LED2		LED3		
	Code	Display status	Code	Display status	Code	Display status	
12_Unit commissioning startup confirmation	db	ON	12	ON	AP		System waits for a unit commissioning startup command.

If it is confirmed to start up the unit, press SW7. The unit will display as follows and start next progress automatically:

Progress	Commissioning code		Progress code		Status code		Meaning
	LED1		LED2		LED3		
	Code	Display status	Code	Display status	Code	Display status	
12_Unit commissioning startup confirmation	db	ON	12	ON	AE	ON	The unit has been set to commissioning operation status of manual calculation of refrigerant charging amount.

Step 17: After unit startup confirmation, system will select cooling/heating/water heating mode according to ambient temperature.

A. If system selects cooling mode and water heating mode, the former part cooling mode will be displayed as below:

Progress	Commissioning code		Progress code		Status code		Meaning
	LED1		LED2		LED3		
	Code	Display status	Code	Display status	Code	Display status	
15_Manual charge first cooling, then water heating operation	db	ON	15	ON	AC	ON	System is in cooling-mode commissioning operation (system automatically selects the commissioning operation mode with no need of manual setting).
	db	ON	15	ON	Corresponding error code	ON	Malfunction occurs during cooling-mode commissioning operation.
	db	ON	15	ON	U9	ON	Malfunction occurs to outdoor unit pipes or valves.
	db	ON	15	ON	XXXX/U8	ON	System detects pipe failure of indoor unit. XXXX means the

GMV5 Home DC Inverter Multi VRF Units

							project number of faulty indoor unit. 3s later, U8 will be displayed. For instance, if no.100 indoor unit has U8 error, then LED3 will display circularly as below: 01(2s later), 00(2s later), U8.
--	--	--	--	--	--	--	---

The latter part water heating mode will be displayed as below:

	Commissioning code		Progress code		Status code		Meaning
Progress	LED1		LED2		LED3		
	Code	Display status	Code	Display status	Code	Display status	
15_Manual charge first cooling, then water heating operation	db	ON	15	ON	11	ON	System is in water-heating-mode commissioning operation (System automatically selects the commissioning operation mode with no need of manual setting).
	db	ON	15	ON	Corresponding error code	ON	Malfunction occurs during cooling-mode commissioning operation.
	db	ON	15	ON	U9	ON	Malfunction occurs to outdoor unit pipes or valves.
	db	ON	15	ON	XXXX/U8	ON	System detects pipe failure of indoor unit. XXXX means the project number of faulty indoor unit. 3s later, U8 will be displayed. For instance, if no.100 indoor unit has U8 error, then LED3 will display circularly as below: 01(2s later), 00(2s later), U8.

B. If system selects heating mode and water heating mode, the former part heating mode will be displayed as below:

	Commissioning code		Progress code		Status code		Meaning
Progress	LED1		LED2		LED3		
	Code	Display status	Code	Display status	Code	Display status	
16_Manual charge first heating, then water heating operation	db	ON	16	ON	AH	ON	System is in heating-mode commissioning operation (system automatically selects the commissioning operation

GMV5 Home DC Inverter Multi VRF Units

							mode with no need of manual setting).
	db	ON	16	ON	Corresponding error code	ON	Malfunction occurs during heating-mode commissioning operation.
	db	ON	16	ON	U9	ON	Malfunction occurs to outdoor unit pipes or valves.
	db	ON	16	ON	XXXX/U8	ON	System detects pipe failure of indoor unit. XXXX means the project number of faulty indoor unit. 3s later, U8 will be displayed. For instance, if no.100 indoor unit has U8 error, then LED3 will display circularly as below: 01(2s later), 00(2s later), U8.

The latter part water heating mode will be displayed as below:

Progress	Commissioning code		Progress code		Status code		Meaning
	LED1		LED2		LED3		
	Code	Display status	Code	Display status	Code	Display status	
16_Manual charge first heating, then water heating operation	db	ON	16	ON	11	ON	System is in water-heating-mode commissioning operation (System automatically selects the commissioning operation mode with no need of manual setting).
	db	ON	16	ON	Corresponding error code	ON	Malfunction occurs during heating-mode commissioning operation.
	db	ON	16	ON	U9	ON	Malfunction occurs to outdoor unit pipes or valves.
	db	ON	16	ON	XXXX/U8	ON	System detects pipe failure of indoor unit. XXXX means the project number of faulty indoor unit. 3s later, U8 will be displayed. For instance, if no.100 indoor unit has U8 error, then LED3 will display circularly as below: 01(2s later), 00(2s later), U8.

Step 18: If no error occurs after the unit has continuously run for 40 minutes, system will automatically confirm that commissioning is completed. The entire unit stops and resumes

standby status with display as below:

Progress	Commissioning code		Progress code		Status code		Meaning
	LED1		LED2		LED3		
	Code	Display status	Code	Display status	Code	Display status	
17_Commissioning completed	0104	ON	OF	ON	OF	ON	The unit has completed commissioning and in standby status. LED1 displays module address. LED2 and LED3 display OF.

Step 19: After commissioning is completed, set functions according to the actual engineering requirements on functions. For specific details, please refer to System Function Setting Method. Skip this step if there is no special requirement.

Step 20: Deliver the product to user for use and inform users about usage precautions.

5. DIP Switch Instructions of GMV5 Unic

5.1 GMV5 Unic Outdoor Unit (GMV-S224W/A-X,GMV-S280W/A-X)

Application of outdoor unit functions includes function DIP switch setting and function button setting, as well as special requirements used for the engineering.

5.1.1 Function DIP Switch Settings

The function DIP switch settings are located at SA1~SA8 from AP1 of outdoor unit main board. Below is the factory settings:

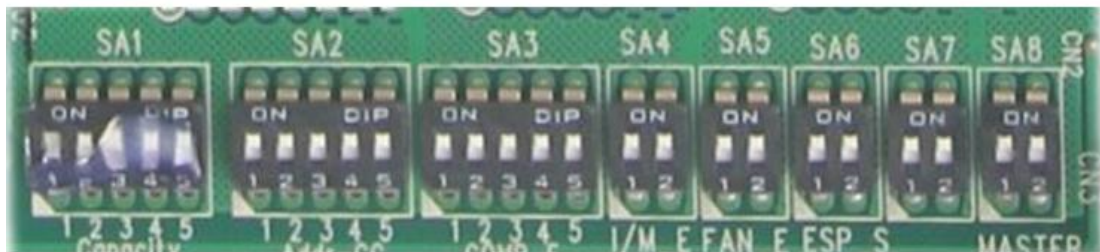

DIP Switch	Name	Meaning	Factory Settings	Remarks
SA1_capacity	Capacity DIP switch	Defines the rated capacity of the unit	Set in factory	The factory setting cannot be changed.
SA2_Addr-CC	Centralized control address DIP switch	Defines and differentiates addresses of different systems in the case of centralized control by multiple systems.	00000	The address DIP switch is used only when centralized control is required. Otherwise, the factory settings are used without being changed.
SA3_COMP-E	Compressor emergency operation	Provides aftersales emergency settings for 2#-6# compressors.	00000	It is better not to use the emergency function. Replace the compressor at the first time

GMV5 Home DC Inverter Multi VRF Units

	DIP switch			when an exception occurs.
SA4_I/M-E	Compressor emergency operation DIP switch	Provides aftersales emergency settings for 1# compressor.	00	It is better not to use the emergency function. Replace the compressor at the first time when an exception occurs.
SA5_FAN-E	Fan emergency operation DIP switch	Provides aftersales emergency settings for fans.	00	It is better not to use the emergency function. Replace relevant parts of the fan at the first time when an exception occurs.
SA6_ESP_S	Outdoor fan static pressure setting DIP switch	Sets the static pressure of the fan according to the static pressure of the exhaust pipeline connected with the engineering unit, to guarantee normal operation of the unit.	00	This DIP switch should be set based on actual engineering conditions, neither over-large nor over-small. It is unnecessary to change the factory settings in outdoor locations.
SA7	Reserved DIP switch	—	00	It has been set before leaving the factory and it's not allowed to be changed.
SA8_MASTER-S	Master unit setting DIP switch	Defines the master unit	00	It has been set before leaving the factory and it's not allowed to be changed.

Instruction:

1) Centralized control address DIP switch (SA2_Addr-CC)

The centralized control address DIP switch (SA2_Addr-CC) indicates the centralized control address required when different refrigerating systems are controlled in a centralized manner. The default factory setting is "00000". If it is not required to use centralized control between multiple refrigerating systems, this DIP switch can retain the factory settings without being changed.

If it is required to use centralized control between multiple refrigerating systems, set the DIP switch according to the following methods:

- A. The DIP switch must be set on the master unit. Otherwise, the setting is invalid;
- B. The centralized control address DIP switch (SA2_Addr-CC) on the master unit of a refrigerating system must be set to "00000", and this system is the master system.
- C. The centralized control address DIP switch (SA2_Addr-CC) on the master unit of other refrigerating systems must be set as follows:

SA2					Add. No.
DIP1	DIP2	DIP3	DIP4	DIP5	
1	0	0	0	0	2
0	1	0	0	0	3
0	0	1	0	0	4
0	0	0	1	0	5
0	0	0	0	1	6
1	0	0	0	1	7
0	1	0	0	1	8
0	0	1	0	1	9

GMV5 Home DC Inverter Multi VRF Units

0	0	0	1	1	10
1	0	0	1	1	11
0	1	0	1	1	12
0	0	1	1	1	13
1	0	1	1	1	14
0	1	1	1	1	15
1	1	1	1	1	16

D. The centralized control address DIP switch (SA2_Addr-CC) cannot be the same between different refrigerating systems. Otherwise, address conflicts may occur and the unit cannot run properly.

2) Compressor Emergency Operation DIP Switch (SA3_COMP-E)

Corresponding to 2#~6# compressors, the compressor emergency operation DIP switch (SA3_COMP-E) is used for aftersales emergency settings when an exception occurs on a compressor. It can shield the operation of the abnormal compressor in a short time and guarantee the emergency operation of other compressors.

When it is required to shield the operation of 2#-6# compressors upon failure, set the DIP switch according to the following methods:

Compressor Emergency Operation DIP Switch (SA3_COMP-E)					Remarks
DIP1	DIP2	DIP3	DIP4	DIP5	
0	0	0	0	0	Not shielding the operation of 2#-6# compressors
1	0	0	0	0	Shielding the operation of 2# compressor
0	1	0	0	0	Shielding the operation of 3# compressor
0	0	1	0	0	Shielding the operation of 4# compressor
0	0	0	1	0	Shielding the operation of 5# compressor
0	0	0	0	1	Shielding the operation of 6# compressor

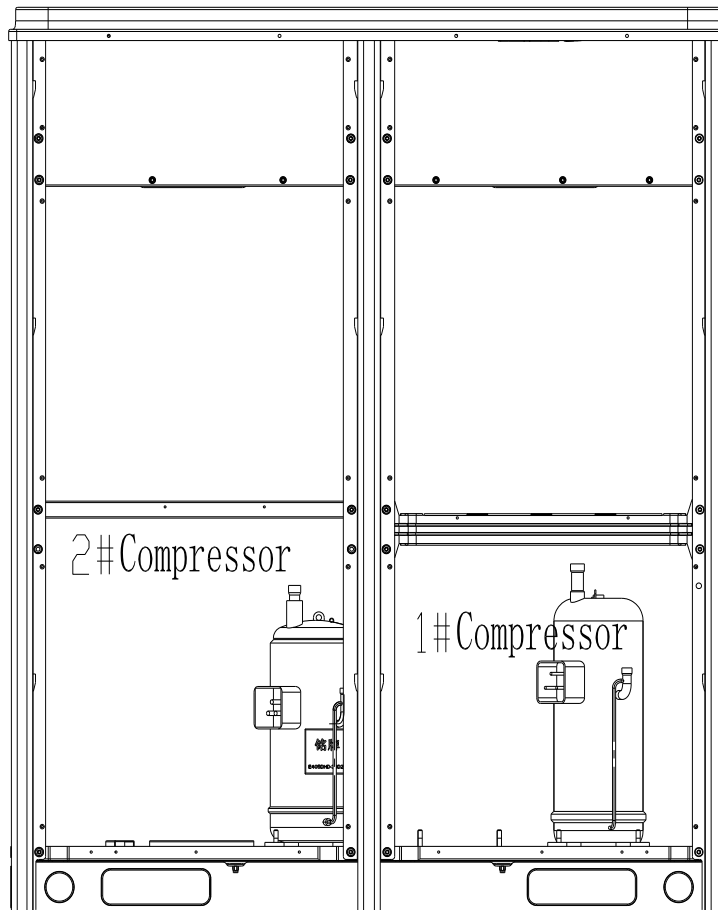

Precautions:

- A. When the DIP switch setting is not covered in the above scope, a DIP switch setting exception fault may occur.
- B. Only one compressor can be set to emergency mode on a module;
- C. The compressor emergency operation mode is valid only in a single-module multi-compressor system.
- D. The default factory setting is "00000";
- E. The system cannot continually run for more than 24 hours in compressor emergency operation status. Once 24 hours are exceeded, the entire unit will be forcibly stopped and the limited operation code "Ad" is displayed on the IDU.
- F. 1#-6# compressors are defined from right to left facing the front of the unit.

3) 1# Compressor Emergency Operation DIP Switch (SA4_I/M-E)

The 1# compressor emergency operation DIP switch (SA4_I/M-E) is used for aftersales emergency settings when an exception occurs on the 1# compressor. It can shield the operation of the abnormal compressor in a short time and guarantee the emergency operation of other compressors.

When it is required to set the 1# compressor as emergency mode, set the DIP switch as follows:

1# Compressor Emergency Operation DIP Switch (SA4_I/M-E)		
DIP1	DIP2	Remarks
0	0	Not shielding the operation of 1# compressor

1	0	Shielding the operation of 1# compressor
---	---	---

Precautions:

- A. When the DIP switch setting is not covered in the above scope, a DIP switch setting exception fault may occur.
- B. Only one compressor can be set as emergency mode on a module.
- C. The compressor emergency operation mode is valid only in a single-module multi-compressor system;
- D. The default factory setting is “00”;
- E. The system cannot continually run for more than 24 hours in compressor emergency operation status. Once 24 hours are exceeded, the entire unit will be forcibly stopped and the limited operation code “Ad” is displayed on the IDU.
- F. 1#-6# compressors are defined from right to left facing the front of the unit.

4) Fan Emergency Operation DIP Switch (SA5_FAN-E)

The fan emergency operation DIP switch (SA5_FAN) is used for aftersales emergency settings when an exception occurs on a dual-module fan. It can shield the operation of a fan in a short time and guarantee the emergency operation of the system.

Fan Positions

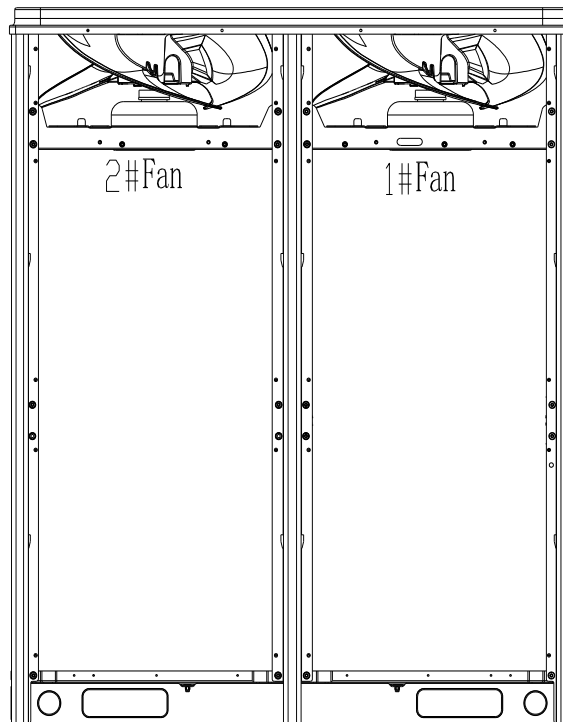

When it is required to set the fan to emergency mode, set the DIP switch as follows:

Fan Emergency Operation DIP Switch (SA5_FAN-E)		
DIP1	DIP2	Remark
0	0	No fan in emergency operation mode
1	0	Shielding the operation of 1#

GMV5 Home DC Inverter Multi VRF Units

		fan
0	1	Shielding the operation of 2# fan

Precautions:

- A. When the DIP switch setting is not covered in the above scope, a DIP switch setting exception fault may occur.
- B. Only one fan can be set to emergency mode on a module.
- C. The default factory setting is “00”.
- D. The system cannot continually run for more than 120 hours in fan emergency operation status. Once 120 hours are exceeded, the entire unit will be forcibly stopped and the limited operation code “Ad” is displayed on the IDU.

5) Outdoor Fan Static Pressure Setting DIP Switch (SA6_ESP_S)

The outdoor fan static pressure setting DIP switch (SA6_ESP_S) is used in special locations such as the unit installation equipment room. In locations where air ducts are required to be connected, zero static pressure, low static pressure, medium static pressure, and histatic pressure can be set according to the design of air ducts. The setting methods are as follows:

Outdoor Fan Static Pressure Setting DIP Switch (SA6_ESP_S)		
DIP1	DIP2	Static Pressure Range
0	0	0Pa
1	0	30Pa
0	1	50Pa
1	1	80Pa

The default factory setting is “00”.

6) Explanation of DIP switch positions

One the DIP switch, “ON” indicates “0” status and the opposite direction indicates “1” status. The position of white lever indicates the position to be set to.

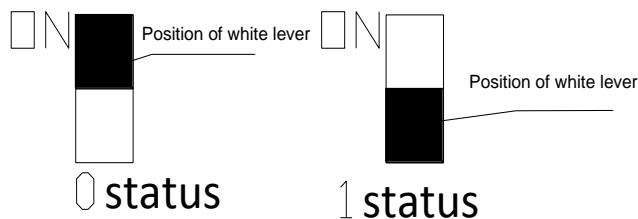

5.1.2 System Function Button Operations

Notes:

- ① System function settings and inquiry must be performed after commissioning of the entire unit.
- ② System function settings and inquiry can be used no matter whether the entire unit runs.

5.1.2.1 Introduction to Function Buttons

The main board AP1 of the outdoor unit consists of eight function buttons:

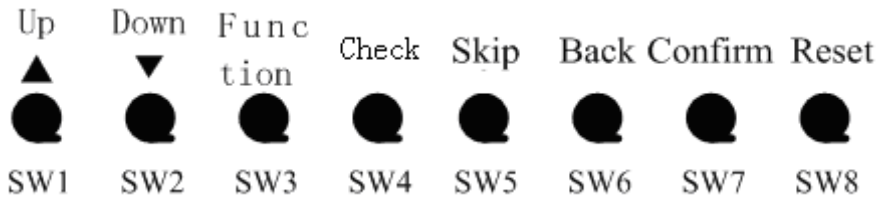

Function Button Name and Meaning		
Button	Code	Function Meaning
SW1	UP	Indicates the upward selection button.
SW2	DOWN	Indicates the downward selection button.
SW3	FUNCTION	Indicates the function button, used for function settings.
SW4	CHECK	Indicates the inquiry button, used for function inquiry.
SW5	SKIP	Indicates the skip button.
SW6	BACK	Indicates the return button, used to return to the upper-level menu.
SW7	CONFIRM	Indicates the confirmation button.
SW8	RESET	Indicates the reset button, used to restore factory settings.

5.1.2.2 Introduction to Functions

1) List of functions

Function Code	Function Name	Function Meaning	Factory Settings		Remarks
			Code	Meaning	
A2	Refrigerant recovery operation	Fully or partially recovers refrigerants in a faulty module or	—	—	It can only be set.
A6	Unit cooling/heating function	Sets the unit to cooling/heating, cooling only, heating only or air supply mode for centralized management.	n	Cooling/heating function	It can be set and inquired
A7	Outdoor silent mode	Sets different silent modes to meet users' requirements.	1	10 kinds of silent modes	It can be set and inquired.
A8	Aftersales vacuuming mode	Automatically enables all electronic expansion valves and valves and electromagnetic valves during maintenance to guarantee vacuum processing in all pipelines.	—	—	It can only be set.
n0	Conservation control 1	Automatically decreases the power consumption of the unit according to system operation parameters.	0	No automatic conservation settings.	It can be set and inquired.
n3	Forcible defrosting operation	Forcibly enables ODU defrosting operation.	—	—	It can only be set.
n4	Conservation control 2	Forcibly decreases the maximum power consumption of the unit	0	No capacity output limitation	It can be set and inquired.

GMV5 Home DC Inverter Multi VRF Units

			settings	
n5	Indoor unit project number offset	Prevents IDU project number conflicts when different refrigerating systems are controlled in a centralized manner.		It can only be set.
n6	Fault inquiry	Inquire historical fault information of the ODU.		It can only be inquired.
n7	Parameter inquiry	Inquire real-time operation parameters of the ODU.		It can only be inquired.
n8	Indoor unit project number inquiry	Displays address of all IDUs via ODU		It can only be inquired.
n9	Online IDU quantity inquiry	Display the quantity of online IDUs.		It can only be inquired.
nb	Outdoor unit bar code function inquiry	Inquire the entire unit bar code and controller barcode of outdoor unit	—	It can only be inquired.

2) Description of Functions

(1) A2 Refrigerant recovery operation

This function partially recovers refrigerants in a faulty module or IDU pipeline during unit maintenance. The refrigerant recovery volume of each basic module is as follows:

Model of ODU	Maximum Refrigerant Recovery Volume (kg)
GMV-S224W/A-X	7.5
GMV-S280W/A-X	7.5

Refrigerant recovery operating mode is refrigerant recovery mode of pipelines of indoor unit.

Refrigerant Recovery Mode Code	Refrigerant Recovery Mode Name	Remarks
01	Indoor unit pipeline refrigerant recovery	This mode is selected when an IDU fails and it is required to recover refrigerants from the IDU pipeline.

When this function is enabled, the ODU automatically starts and recovers refrigerants to the ODU or IDU pipeline.

(2) A6 Unit cooling/heating function

This function sets operation modes of the entire unit, including:

Function Mode of ODU		Operation Mode of IDU
Code	Name	
nA	Cooling/heating	Cooling mode, dry mode, heating mode, floor heating mode, heating water mode, and air supply mode, etc. (Notes: the heating/floor heating mode and cooling/dry

GMV5 Home DC Inverter Multi VRF Units

		mode cannot operate at the same time)
nC	Cooling only	Cooling mode, dry mode, heating water mode, air supply mode, etc.
nH	Heating only	Heating mode, floor heating mode, heating water mode, air supply mode, etc. (Notes: heating mode and air supply mode cannot operate at the same time)
nF	Air supply	Air supply mode.

The user or administrator can set operation modes of the ODU according to actual situations to prevent conflicts.

When it is required to set different refrigerating systems to the same functional mode, set the master system according to the above requirements. For the master system settings, please see the “Centralized Control Address DIP Switch (SA2_Addr-CC)”.

(3) A7 Outdoor silent mode

This function is used when users require lower environment noises, including night-time automatic silent mode and forcible silent mode.

For the night-time automatic silent mode, the system can automatically judges the highest daytime environment temperature and then starts silent operations in a certain interval to guarantee night-time low-noise operation. There are nine types of night-time automatic silent modes for selection:

Silent Mode	Code	Starting the Silent Mode X Hours after the Daytime Temperature Reaches the Highest	Stopping the Night-time Silent Mode after Continual Operations for Y Hours	Noise Degree
Mode 1	01	6	10	Low-noise mode
Mode 2	02	6	12	
Mode 3	03	8	8	
Mode 4	04	8	10	
Mode 5	05	10	8	
Mode 6	06	10	10	
Mode 7	07	4	14	
Mode 8	08	6	8	Low and medium noise mode
Mode 9	09	12	10	Superlow-noise mode

Note: The highest daytime temperature is generally in 13:00-15:00.

For the forcible silent mode, the system runs in low-noise mode no matter in the daytime or night-time. The forcible silent mode fails in three categories:

Silent Mode	Code	Noise Degree
Mode 10	10	Low-noise mode
Mode 11	11	Low and medium noise mode
Mode 12	12	Superlow-noise mode

Notes: The system capacity may fall off after the silent mode is set. Therefore, try to balance the noise with the capacity in selecting a silent mode category. The factory setting is “00”.

(4) A8 Aftersales vacuuming mode

This function ensures the vacuum degree of the entire system during maintenance to prevent operation functions of dead zones. Expansion valves and electromagnetic valves of the unit will be enabled after this function is set.

(5) nO Conservation control 1

System conservation is set when conservation operations are required. The default factory setting is capacity priority control mode. The system capacity may fall off after the conservation mode is set.

Code	Function Name
01	Conservation control – invalid (factory settings)
02	Conservation control – valid

(6) n3 Forcible defrosting operation

This function is set when forcible defrosting is required for the unit during maintenance. After this function is enabled, the system automatically quits according to quitting conditions and then automatically runs based on system conditions.

(7) n4 Conservation control 2

The highest capacity output limitation is set when users require forcibly limiting the system power consumption. The setting scope is as follows:

Code	Highest Output Capacity
10	100% (factory settings)
09	90%
08	80%
07	70%

Note: The cooling or heating effect may fall off after the capacity limitation is set.

(8) n5 Indoor unit project number offset

This function sets the IDU project number when multiple refrigerating systems are controlled in a centralized manner (by using a remote monitor or centralized controller), avoiding the same project number between different systems. If the project number is not set, project number conflicts may occur among systems.

This function only needs to be set on the master system, which is the system with the centralized control address SA2 DIP switch being “00000”. For details, see the “Centralized Control Address DIP Switch (SA2_Addr-CC)”.

(9) n6 Fault inquiry

This function inquires historical faults of the system. Up to five historical faults can be memorized in time order.

(10) n7 Parameter inquiry

This function inquires operation parameter of each module of the ODU in real time.

(11) n8 Indoor unit address inquiry

This function inquires addresses of all IDUs through one operation of the ODU.

(12) n9 Online IDU quantity inquiry

This function inquires the quantity of online IDUs through the ODU.

5.1.3 Function Setting Operations

Step 1: Open the commissioning window of the master unit panel;

Step 2: Power on the entire unit;

Step 3: Press “SW3” on the master unit to enter the to-be-selected status of function settings.

By default, the master unit is displayed as below:

LED1		LED2		LED3	
Function Code	Display Mode	Current Progress	Display Mode	Current Status	Display Mode
A7	Flicker	00	Flicker	00	Flicker

Users can select corresponding functions by pressing “SW1 (UP)” or “SW2 (DOWN)” on the master unit, including:

GMV5 Home DC Inverter Multi VRF Units

LED1		LED2		LED3	
Function Code	Display Mode	Current Progress	Display Mode	Current Status	Display Mode
A7	Flicker	00	Flicker	00	Flicker
A6	Flicker	00	Flicker	00	Flicker
A2	Flicker	00	Flicker	00	Flicker
A8	Flicker	00	Flicker	00	Flicker
n0	Flicker	01	Flicker	00	Flicker
n3	Flicker	00	Flicker	00	Flicker
n4	Flicker	00	Flicker	00	Flicker
n5	Flicker	00	Flicker	00	Flicker

After selecting the functions to be set, press SW7 to confirm entering function settings. The master unit is displayed as below:

LED1		LED2		LED3	
Function Code	Display Mode	Current Progress	Display Mode	Current Status	Display Mode
A7	On	00	Flicker	OC	Flicker
A6	On	nC	Flicker	nC	Flicker
A2	On	01	Flicker	00	Flicker
A8	On	00	Flicker	OC	Flicker
n0	On	01	Flicker	OC	Flicker
n3	On	00	Flicker	00	Flicker
n4	On	10	Flicker	OC	Flicker
n5	On	00	Flicker	OC	Flicker

Then go to step 4 to set corresponding functions. Step 4: Set function parameters. Setting methods of function parameters are as below: A7 A7 Outdoor silent mode setting1A7

Step 1: Confirm entering the A7 outdoor silent mode settings. The master unit is displayed as below:

LED1		LED2		LED3	
Function Code	Display Mode	Silent Mode Code	Display Mode	Current Status	Display Mode
A7	On	00	Flicker	OC	Flicker

Step 2: Select a corresponding silent mode by pressing SW1 (UP) or SW2 (DOWN).

LED1		LED2		LED3	
Function Code	Display Mode	Silent Mode Code	Display Mode	Current Status	Display Mode
A7	On	00	Flicker	OC	Flicker
A7	On	01	Flicker	OC	Flicker
A7	On	02	Flicker	OC	Flicker
A7	On	03	Flicker	OC	Flicker
A7	On	04	Flicker	OC	Flicker
A7	On	05	Flicker	OC	Flicker
A7	On	06	Flicker	OC	Flicker
A7	On	07	Flicker	OC	Flicker
A7	On	08	Flicker	OC	Flicker
A7	On	09	Flicker	OC	Flicker

GMV5 Home DC Inverter Multi VRF Units

A7	On	10	Flicker	OC	Flicker
A7	On	11	Flicker	OC	Flicker
A7	On	12	Flicker	OC	Flicker

Step 3: Press SW7 to confirm selecting the mode. The master unit is displayed as below:

LED1		LED2		LED3	
Function Code	Display Mode	Silent Mode Code	Display Mode	Current Status	Display Mode
A7	On	00	On	OC	On
A7	On	01	On	OC	On
A7	On	02	On	OC	On
A7	On	03	On	OC	On
A7	On	04	On	OC	On
A7	On	05	On	OC	On
A7	On	06	On	OC	On
A7	On	07	On	OC	On
A7	On	08	On	OC	On
A7	On	09	On	OC	On
A7	On	10	On	OC	On
A7	On	11	On	OC	On
A7	On	12	On	OC	On

On the master unit, press SW6 to return to the upper level (press SW6 in setting status to return to the upper level; press SW6 after settings are completed to resume to the normal operating status of the unit).

If no button operations are performed on the master unit for five minutes, the function setting automatically quits and the unit resumes the current status.

The default factory setting is 00, that is, silent mode 10.

① A6 Unit cooling/heating function settings

Step 1: Confirm entering into the A6 unit cooling/heating function settings. The outdoor unit will display as below:

LED1		LED2		LED3	
Function Code	Display Mode	ODU Function Mode Code	Display Mode	ODU Function Mode Code	Display Mode
A6	On	nC	Flicker	nC	Flicker

Step 2: Select a corresponding cooling/heating function by pressing SW1 (UP) or SW2 (DOWN).

LED1		LED2		LED3	
Function Code	Display Mode	ODU Function Mode Code	Display Mode	ODU Function Mode Code	Display Mode
A6	On	nC	Flicker	nC	Flicker
A6	On	nH	Flicker	nH	Flicker
A6	On	nA	Flicker	nA	Flicker
A6	On	nF	Flicker	nF	Flicker

Step 3: Press SW7 to confirm selecting the mode. The master unit is displayed as below:

GMV5 Home DC Inverter Multi VRF Units

LED1		LED2		LED3	
Function Code	Display Mode	ODU Function Code	Display Mode	ODU Function Code	Display Mode
A6	On	nC	On	nC	On
A6	On	nH	On	nH	On
A6	On	nA	On	nA	On
A6	On	nF	On	nF	On

On the outdoor unit, press SW6 to return to the upper level (press SW6 in setting status to return to the upper level; press SW6 after settings are completed to resume to the normal operating status of the unit).

If no button operations are performed on the master unit for five minutes, the function setting automatically quits and the unit resumes to the current status.

The default factory setting is nA cooling/heating.

A2 Refrigerant recovery operation settings

Step 1: After entering into the A2 refrigerant recovery operation settings, the master unit will display as below:

LED1		LED2		LED3	
Function Code	Display Mode	Refrigerant Recovery Code	Display Mode	Current Status	Display Mode
A2	On	01	Flicker	00	Flicker

Step 2: The default setting is 01. Select 01 or 02 by pressing SW1 (UP) or SW2 (DOWN). Press SW7 to confirm selecting the mode.

On the outdoor unit, press SW6 to return to the upper level.

If no button operations are performed on the master unit for five minutes, the function setting automatically quits and the unit resumes to the current status.

Step 3: Select 01 as in step 2 to enter into IDU refrigerant recovery. Digital LEDs and status LEDs of all basic modules will display as below:

LED1		LED2		LED3	
Function Code	Display Mode	Refrigerant Recovery Code	Display Mode	Current Status	Display Mode
A2	On	01	On	[Module oow-pressure Ps]	On

LED3 shows the low-pressure value of a module. If the value is negative, LED3 circularly displays the negative code nE and the numeric value in every one second. For example, for -30C, LED3 alternately displays nE for one second and then 30 for another second.

Step 4: Close liquid-tube stop valves of all basic modules of the ODU. When the low-pressure value displayed in LED3 continually flickers, quickly close air-tube stop valves of all basic modules and then press SW7 on the master unit to confirm completing refrigerant recovery or power off the entire unit.

If no operations are performed after the low-pressure value displayed on LED3 continually flickers for three minutes, the entire unit will be forcibly stopped.

On the master unit, press SW6 to return to the upper level for resuming to the standby status of the entire unit (press SW6 in setting status to return to the upper level; press SW6 after settings are completed to resume to the normal operating status of the unit).

Notes:

Another startup is not allowed within 10 minutes after refrigerant recovery.

A8 aftersales vacuuming mode setting

Step 1: After entering into A8 aftersales vacuuming mode setting, the master unit will display as below:

LED1		LED2		LED3	
Function Code	Display Mode	Current Progress	Display Mode	Current Status	Display Mode

GMV5 Home DC Inverter Multi VRF Units

A8	On	00	Flicker	OC	Flicker
----	----	----	---------	----	---------

Enter the to-be-confirmed status of system vacuuming mode settings.

Step 2: Press SW7 to confirm entering into the to-be-confirmed status of system vacuuming mode settings. All modules are displayed as below:

LED1		LED2		LED3	
Function Code	Display Mode	Current Progress	Display Mode	Current Status	Display Mode
A8	On	00	On	OC	On

Expansion valves and electromagnetic valves of all outdoor and IDUs are opened, and the entire unit cannot be enabled.

Press SW6 on the master unit to quit the vacuuming status. Alternatively, the entire unit quits the vacuuming status after 24 hours.

System conservation operation settings

Step 1: After entering into n0 system conservation operation settings, the master unit will display as below:

LED1		LED2		LED3	
Function Code	Display Mode	Code	Display Mode	Current Status	Display Mode
n0	On	01	Flicker	OC	Flicker

Step 2: Select a corresponding mode by pressing SW1 (UP) or SW2 (DOWN).

LED1		LED2		LED3	
Function Code	Display Mode	Code	Display Mode	Current Status	Display Mode
n0	On	01	Flicker	OC	Flicker
n0	On	02	Flicker	OC	Flicker

Step 3: Press SW7 to confirm selecting the mode. The master unit will display as below:

LED1		LED2		LED3	
Function Code	Display Mode	Code	Display Mode	Current Status	Display Mode
n0	On	01	On	OC	On
n0	On	02	On	OC	On

If no button operations are performed for five minutes, the function setting automatically quits and the unit restores the current status. (Press SW6 in setting status to return to the upper level; press SW6 after settings are completed to resume to the normal operating status of the unit.)

Forcible defrosting operation settings

Step 1: After entering into n3 forcible defrosting operation settings, the master unit will display as below:

LED1		LED2		LED3	
Function Code	Display Mode	Current Progress/Mode	Display Mode	Current Status	Display Mode
n3	On	00	Flicker	00	Flicker

Step 2: Press SW7 to confirm entering into forcible defrosting, the master module will display as below:

LED1		LED2		LED3	
Function Code	Display Mode	Current Progress/Mode	Display Mode	Current Status	Display Mode

GMV5 Home DC Inverter Multi VRF Units

n3	On	00	On	00	On
----	----	----	----	----	----

When the unit reaches defrosting quit conditions, the system automatically quits and resumes to the normal operation control.

Highest capacity output limitation settings

Step 1: After entering into n4 highest capacity output limitation setting, the master unit will display as below:

LED1		LED2		LED3	
Function Code	Display Mode	Highest Output Capacity	Display Mode	Current Status	Display Mode
n4	On	10	Flicker	OC	Flicker

Step 2: Select a corresponding capacity limitation value by pressing SW1 (UP) or SW2 (DOWN).

LED1		LED2		LED3	
Function Code	Display Mode	Highest Output Capacity	Display Mode	Current Status	Display Mode
n4	On	10	Flicker	OC	Flicker
n4	On	09	Flicker	OC	Flicker
n4	On	08	Flicker	OC	Flicker
n4	On	07	Flicker	OC	Flicker

Step 3: Press SW7 to confirm selecting the mode. The master module will display as below:

LED1		LED2		LED3	
Function Code	Display Mode	Highest Output Capacity	Display Mode	Current Status	Display Mode
n4	On	10	On	OC	On
n4	On	09	On	OC	On
n4	On	08	On	OC	On
n4	On	07	On	OC	On

If no button operation are performed on the master unit for five minutes, the function setting automatically quits and the unit resumes to the current status. (Press SW6 in setting status to return to the upper level; press SW6 after settings are completed to resume to the normal operating status of the unit.)

Indoor unit project number offset setting

Step 1: After entering into n5 indoor unit project number offset setting, the master unit will display as below:

LED1		LED2		LED3	
Function Code	Display Mode	Current Progress/Mode	Display Mode	Current Status	Display Mode
n5	On	00	Flicker	00	Flicker

Step 2: Press SW7 to send the project number offset command. The master module will display as below:

GMV5 Home DC Inverter Multi VRF Units

LED1		LED2		LED3	
Function Code	Display Mode	Current Progress/Mode	Display Mode	Current Status	Display Mode
n5	On	00	On	OC	On

After 10 seconds later, the system quits this mode and resumes to the normal operation mode.

Note: This function only needs to be operated on the master system, which is the system with the centralized control address SA2 DIP switch being 00000. For details, see the Centralized Control Address DIP Switch (SA2_Addr-CC).

5.1.4 Function Inquiry Operation

Step 1: Open the commissioning window of the master unit panel.

Step 2: Power on the entire unit.

Step 3: Press SW4 on the master unit to enter into inquiry status;

Step 4: Select a function to be inquired by pressing SW1 (UP) or SW2 (DOWN) on the master unit. By default, the A7 outdoor silent mode will display for inquiry.

For example, select the A6 unit cooling/heating function. The display is as below:

LED1		LED2		LED3	
Function Code	Display Mode	ODU Function Code	Display Mode	ODU Function Code	Display Mode
A6	On	nA	On	nA	On

Step 5: If the n8 IDU address inquiry is selected, the display is as follows. Enter the to-be-confirmed status of IDU project number inquiry.

LED1		LED2		LED3	
Function Code	Display Mode	Current Progress/Mode	Display Mode	Current Status	Display Mode
n8	Flicker	00	Flicker	00	Flicker

Press “SW7” and select the IDU project number inquiry on the master unit. The master unit will display as below:

LED1		LED2		LED3	
Function Code	Display Mode	Current Progress/Mode	Display Mode	Current Status	Display Mode
n8	On	00	On	00	On

Regardless of the current display status of wired controllers or display panels of all IDUs, the current display status are all switched to the IDU project number. However, it will not influence the settings and operation status of outdoor and IDUs.

此 On the master unit, press “SW6” to return to the upper level. The IDU retains the project number display status.

On the master unit, press and hold “SW6” to quit the address display status for all IDUs and return to the upper level.

If no quit button operations are performed on the master unit for 30 minutes, the function setting automatically quits and the unit resumes to the current status.

Step 6: If the n9 IDU address inquiry is selected, the display will as below:

LED1		LED2		LED3	
Function Code	Display Mode	Quantity of IDUs (kilobit and hundred-bit)	Display Mode	Quantity of IDUs (Ten-bit and one-bit)	Display Mode

GMV5 Home DC Inverter Multi VRF Units

n9	On	00	On	00	Flicker
----	----	----	----	----	---------

The nixie tube of LED2 displays kilobit and hundred-bit, nixie tube of LED3 displays ten-bit and one-bit. For example, if the quantity of IDUs is 75, "0075" is displayed.

If no button operations are performed on the master unit for five minutes, the function setting automatically quits and the unit resumes to the current status.

Notes: The online IDU quantity inquiry function can only inquire quantity of IDU (including hydro box) of cooling only system.

Step 7: If the n6 fault inquiry is selected, it will display as below and enter into the to-be-confirmed status of fault inquiry.

LED1		LED2		LED3	
Function Code	Display Mode	Current Progress/Mode	Display Mode	Current Status	Display Mode
n6	Flicker	00	Flicker	00	Flicker

Press "SW7" on the master unit to confirm fault inquiry.

Press SW1 (UP) or SW2 (DOWN), LED3 will alternately display the historical fault code and module address in an interval of one second in the sequence of fault records. LED2 will display the fault sequence number. If there are no fault records, LED2 and LED3 will display "00" by default. Up to five historical faults can be inquired. The faults that can be inquired are as below:

Code		Code	
E1	High-pressure protection	P9	Inverter compressor out-of-step protection
E3	Low-pressure protection	C2	Communication failure between the master unit and inverter compressor driver
U4	Refrigerant shortage protection	P8	Over-high temperature protection of inverter compressor driver module
E2	Discharge low-temperature protection	P7	Temperature sensor failure of inverter compressor driver module
J9	Over-low pressure ratio protection	PF	Charge circuit failure of inverter compressor driver
J8	Over-high pressure ratio protection	HL	DC bus bar over-low voltage protection of inverter outdoor fan driver
J7	Four-way valve leakage protection	HH	DC bus bar over-high voltage protection of inverter outdoor fan driver
E5	High-temperature protection of compressor 1	H6	IPM Inverter outdoor fan driver IPM module protection
E6	High-temperature protection of compressor 2	HJ	Inverter outdoor fan startup failure
J2	Over-current protection of compressor 2	HE	Inverter outdoor fan phase lacking protection
EU	Top high-temperature protection of compressor 1	H3	Inverter outdoor fan driver module reset
Eb	Top high-temperature protection of compressor 2	H5	Inverter outdoor fan over-current protection
PL	DC bus bar over-low voltage protection of inverter compressor driver	HC	Current detection circuit failure of inverter outdoor fan driver
PH	DC bus bar over-high voltage protection for inverter	H9	Inverter outdoor fan out-of-step protection

GMV5 Home DC Inverter Multi VRF Units

	compressor driver		
P6	IPM module protection of inverter compressor driver	C3	Communication failure between the master unit and inverter outdoor fan driver
PJ	Inverter compressor startup failure	H8	Over-high temperature protection of inverter outdoor fan driver module
PE	Inverter compressor phase lacking protection	H7	Temperature sensor failure of inverter outdoor fan driver module
P3	Inverter compressor driver module reset		
P5	Inverter compressor over-current protection		
PC	Current detection circuit failure of inverter compressor driver		

The display are as below:

LED1		LED2		LED3	
Function Code	Display Mode	Fault Sequence	Display Mode	Current Status	Display Mode
n6	On	01	On	Corresponding historical fault/module address	Alternately display
n6	On	02	On		Alternately display
n6	On	03	On		Alternately display
n6	On	04	On		Alternately display
n6	On	05	On		Alternately display

If there are less than five historical faults, LED2 and LED3 display “00” indicating there are no more historical faults after the last fault is displayed.

Under fault inquiry status, press and hold “SW7” for five seconds to clear all historical faults of the ODU.

Step 8: If the n7 parameter inquiry is selected, the display is as below. The unit enters into to-be-confirmed status of parameter inquiry.

LED1		LED2		LED3	
Function Code	Display Mode	Current Progress/Mode	Display Mode	Current Status	Display Mode
n7	Flicker	00	Flicker	00	Flicker

On the master unit, press “SW7” to confirm parameter inquiry and enter into module confirmation status for parameter inquiry. The display is as below:

LED1		LED2		LED3	
Function Code	Display Mode	Module Address	Display Mode	Current Status	Display Mode
n7	On	01	Flicker	00	Flicker

Select corresponding outdoor unit for inquiry by pressing SW1 (UP) or SW2 (DOWN) and then press SW7 to confirm. The display is as below:

LED1	LED2	LED3

GMV5 Home DC Inverter Multi VRF Units

Function Code	Display Mode	Parameter Code	Display Mode	Current Status	Display Mode
n7	On	XX	On	Parameter value	Flicker

LED2 displays the parameter code of the module and LED3 displays the parameter value. Parameters are displayed in the following sequence. By default, the outdoor ambient temperature value is displayed. Select a corresponding parameter value by pressing SW1 (UP) or SW2 (DOWN).

Parameter Code	Parameter Name	Remarks
01	Outdoor ambient temperature	
02	Operating frequency of compressor 1	
03	Operating frequency of compressor 2	
04	Operating frequency of outdoor fan	
05	Module high-pressure	
06	Module low-pressure	
07	Discharge temperature of compressor 1	
08	Discharge temperature of compressor 2	
09	Discharge temperature of compressor 3	GMV Unic This parameter is invalid for the GMV Unic series
10	Discharge temperature of compressor 4	GMV Unic This parameter is invalid for the GMV Unic series
11	Discharge temperature of compressor 5	GMV Unic This parameter is invalid for the GMV Unic series
12	Discharge temperature of compressor 6	GMV Unic This parameter is invalid for the GMV Unic series
13	Operating frequency of compressor 3	This parameter is invalid for the GMV Unic series
14	Current value of compressor 1	
15	Current value of compressor 2	
16	Current value of compressor 3	This parameter is invalid for the GMV Unic series
17	Current value of compressor 4	This parameter is invalid for the GMV Unic series
18	Current value of compressor 5	This parameter is invalid for the GMV Unic series
19	Current value of compressor 6	This parameter is invalid for the GMV Unic series

GMV5 Home DC Inverter Multi VRF Units

20	Reserved	
21	Module temperature of compressor 1	
22	Module temperature of compressor 2	
23	Module temperature of outdoor fan 1	
24	Module temperature of outdoor fan 2	
25	Outdoor unit heating EXV1	
26	Outdoor unit heating EXV 2	
27	Subcooler EXV	
28	Defrosting temperature	
29	Liquid-extracting temperature of subcooler	
30	Outlet temperature of steam separator	
31	Oil return temperature	This parameter is invalid for the GMV Unic series
32	Inlet-tube temperature of condenser	
33	Outlet temperature of condenser	

Notes:

① If a parameter value is negative, LED3 will circularly display the negative code “nE” and the numeric value at every one second. For example, for -30°C, LED3 will alternately display “nE” for one second and then “30” for another second.

② The discharge temperature and ambient temperature will be displayed as four-digit values, circularly displaying the higher two digits and then the lower two digits. For example, if 01 and 15 are alternately displayed, it indicates 115°C. If nE, 00, 28 are alternately displayed, it indicates -28°C.

③ If a parameter is invalid for the unit, “00” is displayed. If no button operations are performed on the master unit for five minutes, the function setting will automatically quit and the unit will resumes to the current status.

Step 9: If the “nb ODU barcode inquiry” is selected, it will display as below and enter into “to-be-confirmed status of ODU barcode inquiry”.

LED1		LED2		LED3	
Function Code	Display Mode	Current Progress/Mode	Display Mode	Current Status	Display Mode
nb	Flicker	00	Flicker	00	Flicker

Press SW7 on the master unit to enter into the next-level menu selection. The display is as below:

LED1		LED2		LED3	
Function Code	Display Mode	Module Address	Display Mode	Current Status	Display Mode
nb	On	01	Flicker	00	Flicker

Select corresponding outdoor unit for inquiry by pressing SW1 (▲) and SW2 (▼) and then press SW7 to confirm. The display is as below:

LED1		LED2		LED3	
------	--	------	--	------	--

GMV5 Home DC Inverter Multi VRF Units

Function Code	Display Mode	Parameter Code	Display Mode	Current Status	Display Mode
nb	On	Un/Pc	Flicker	-n	Flicker

Notes: Un indicates the entire-unit barcode and Pc indicates the controller barcode.

After confirming the module, select a barcode sequence by pressing SW1 (▲) or SW2 (▼). The displayed sequence is as below:

Entire-unit barcode (1-13 bits) and controller barcode (1-13 bits), that is, entire-unit barcode header → entire-unit barcode (1-6 bits) → entire-unit barcode (7-12 bits) → entire-unit barcode (13 bit) → controller barcode header → controller barcode (1-6 bits) → controller barcode (7-12 bits) → controller barcode (13 bit). The display is as below:

LED1		LED2		LED3	
Parameter Code	Display Mode	Parameter Code	Display Mode	Parameter Code	Display Mode
Barcode	On	Barcode	On	Barcode	On

Example:

N1R0128150066

Barcode of entire-unit: N1R0128150066

N1M0128150067

Barcode of controller: N1M0128150067

Display sequence is as below:

LED1		LED2		LED3	
Parameter Code	Display Mode	Parameter Code	Display Mode	Parameter Code	Display Mode
nb	On	Un	Flicker	-n	Flicker

LED1		LED2		LED3	
Parameter Code	Display Mode	Parameter Code	Display Mode	Parameter Code	Display Mode
N1	On	R0	On	12	On

LED1		LED2		LED3	
Parameter Code	Display Mode	Parameter Code	Display Mode	Parameter Code	Display Mode
81	On	50	On	06	On

LED1		LED2		LED3	
Parameter Code	Display Mode	Parameter Code	Display Mode	Parameter Code	Display Mode
6X	On/Off	XX	Off	XX	Off

LED1		LED2		LED3	
Parameter Code	Display Mode	Parameter Code	Display Mode	Parameter Code	Display Mode
nb	On	Pc	Flicker	-n	Flicker

LED1		LED2		LED3	
Parameter Code	Display Mode	Parameter Code	Display Mode	Parameter Code	Display Mode
N1	On	M0	On	12	On

LED1		LED2		LED3	
Parameter Code	Display Mode	Parameter Code	Display Mode	Parameter Code	Display Mode
81	On	50	On	06	On

LED1		LED2		LED3	
Parameter Code	Display Mode	Parameter Code	Display Mode	Parameter Code	Display Mode
7X	On/Off	XX	Off	XX	Off

If a parameter is invalid for the unit, “00” is displayed.

On the master unit, press SW6 to return to the upper level if there are two levels of menu. Press SW4 to quit the inquiry status.

If no button operations are performed on the master unit for five minutes, the function setting automatically quits and the unit resumes to the current status.

Step 10: In inquiry status, press SW4 to quit the status.

5.1.5 Resuming Factory Settings

Resuming Factory Settings	Setting Method		
Resuming setting 1	Press and hold SW8 on the master unit for more than 10 seconds.	All the LEDs will flicker for three seconds.	All the factory settings of the ODU are resumed and the unit will wait for re-commissioning.
Resuming setting 2	Press and hold SW3 and SW8 on the master unit for more than 10 seconds.	All the LEDs will flicker for 5 seconds.	Re-commissioning is not required, The quantity of outdoor and indoor units is memorized. Addresses of outdoor and indoor units are all cleared. All the other functional settings are cleared.
Resuming setting 3	Press and hold SW5 and SW8 on the master unit for more than 10 seconds.	All the LEDs will flicker for 7 seconds.	Re-commissioning is not required. The quantity of outdoor and indoor units is memorized. Addresses of outdoor and indoor units retain the preceding settings. All the other functional settings are cleared.

5.2 Hydro Box (NRQD16G/A-S)

5.2.1 Functional Dial Switch of Hydro Box NRQD16G/A-S

Functional dial switches of unit are in S1 and S2 of mainboard AP1, the default factory settings are as below:

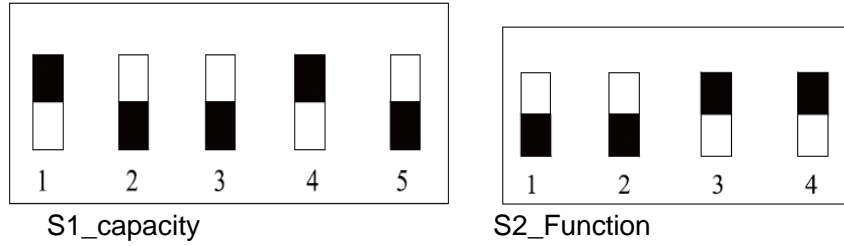

Code	Name	Meaning	Default Setting	Remarks
S1_capacity	Capacity Code	Nominal rated capacity of unit	Default	The default factory settings are completed, which cannot be changed.
S2_Function	Functional dial switch	Setting of equipments for connecting hydro box	1100	After finishing installing the unit, conduct dial switch setting according to actual connected equipment.

Instruction:

1) Functional Dial Switch (S2_Function)

The functional dial switch is four-digit: "1", "2", "3", "4", which respectively represent the following Gree water tank, floor heating, solar energy, self-made water tank. Each type of functional dial switch: dial "OFF" means the function is "connected", dial "ON" means the function is "disconnected".

"1" and "2" must be set according to actual engineering situation, "3" and "4" is not allowed to be changed arbitrarily, otherwise it may cause temperature sensor failure or the unit cannot operate normally.

Specific meanings are as below:

Serial No. of Dial Switch	Meaning	Dial Switch		Default Setting
		disconnected	connected	
1	Gree water tank	ON	OFF	OFF
2	Floor heating	ON	OFF	OFF
3	Solar energy	ON	OFF	ON
4	Self-made water tank	ON	OFF	ON

5.2.2 Functional Application of Hydro Box

Functions of hydro box covers user operation functions and engineering application functions. For user operation functions please refer to instruction manual of hydro box and wired controller.

Engineering application functions include:

SN	Function Name
----	---------------

1	Engineering No. Inquiry and Setting
2	User Parameter Inquiry
3	User Parameter Setting
4	Engineering Parameter Inquiry
5	Engineering Parameter Setting

Engineering application functions can be operated via wired controller of hydro box (model: XK56).

5.2.2.1 Engineering Application Functions Operated via XK56 Wired Controller

Engineering inquiry and setting of hydro box

The setting is the same as inquiry and setting for engineering No. of indoor unit, as below:

1. Engineering No. inquiry of a single indoor unit

Press and hold the “Function” button for five seconds in power-on or power-off status to enter into parameter inquiry interface “C00”. The timer area of wired controller will display the engineering No. of the current indoor unit. If the current wired controller works in one-to-many mode, the displayed indoor unit in the timer area is the unit with the minimum project No.;

2. Inquiry for engineering No. of multiple indoor units

① Engineering No. inquiry of indoor units in one-to-many mode: press and hold the “Function” button for five seconds in power-on or power-off status to enter into parameter inquiry interface “C00”. Press “▽” to switch to “C01”, and then press the “Mode” button to enter to inquiry. The timer area displays engineering No. of indoor unit from small to large. Press “△” or “▽” to switch engineering number.

Notes: It is normal if the buzzer of the indoor unit operated by the wired controller rings. The purpose of ringing the buzzer is to facilitate engineering commissioning personnel to locate the indoor unit, especially for the indoor unit without any LED panel because it cannot display its engineering number.

② Engineering number inquiry of indoor units in the entire communication network: Press and hold “Function” button for five seconds in power-on or power-off status to enter into parameter inquiry interface “C00”. Press “▽” button to switch to “C18”, and then press “Mode” button to enter the inquiry. The timer area of wired controller of the whole network will display engineering No. of corresponding indoor unit.

Method for quitting inquiry:

Quit the “C18” inquiry interface;

Press the “ON/OFF” button on any wired controller in the network.

3. Engineering No. Setting of Indoor Unit

Press and hold the “Function” button for five seconds in power-on or power-off status to enter into parameter inquiry interface “C00”. Continuously press the “Mode” button for three times, and then press and hold the “Function” button for five seconds to enter into engineering parameter setting interface. The temperature area displays “P00”. Press “▽” button to switch to “P42”.

A single indoor unit: press “Mode” button, the engineering No. in timer area flickers, press “△” or “▽” button to adjust engineering No., and then press “Enter” button to conform the setting and return to the upper-level menu.

One-to-many unit: Press the “Mode” button to enter into indoor unit selection menu. Press “△” or “▽” button to switch indoor unit, and press “Mode” button to set the engineering number of current indoor unit, as the above methods.

User Parameter Inquiry

User parameter can be inquired under power-on or power-off status.

1、 Press and hold the “Function” button for five seconds to enter into user parameter inquiry interface, the temperature area displays “C00”, and the “View” icon is on;

2、 Select a parameter code by pressing “▲” or “▼” button.

3、 Press “Enter/Cancel” button to return to the upper-level menu till quitting parameter inquiry.

User parameter inquiry list is as below:

GMV5 Home DC Inverter Multi VRF Units

Table 2.1 User Parameter Inquiry List

Parameter Code	Parameter Name	Parameter Range	View Method
C00	Parameter setting ingress	-	Under "C00" status, the timer area displays the engineering number of the current hydro box; when one wired controller simultaneously controls multiple hydro boxes, it will only display the minimum engineering number.
C01	Inquiry of engineering number of indoor unit (hydro box) and locating of faulty indoor unit (hydro box)	1-255: online engineering number of indoor unit	<p>Operating method: Enter into inquiry: under "C01" status, press "Mode" button to enter into engineering number inquiry interface of hydro box, press "▲" or "▼" to switch engineering number of hydro box.</p> <p>Display mode: Temperature area: displays the current hydro box is faulty (it only displays the faulty hydro box, when there are more than on hydro boxes are faulty, temperature area will display alternately with an interval of 3 seconds); Timer area: (engineering numbers conflict C5 fault)/displays the engineering number of the current hydro box.</p> <p>Notes: "C01" inquiry will not automatically quit if it is overtime, it can only quit manually;</p>
C03	Quantity inquiry for indoor unit (including hydro box) of system network	1-80	Timer area: displays total quantity of indoor units (including indoor unit and hydro box) of the system
C06	Prior operation inquiry	00: general operation 01: prior operation	<p>Operating method: Enter into inquiry, under the "C06" status, press "Mode" button to enter into prior operation inquiry interface, press "" or "" button to switch number of hydro box.</p> <p>Display mode: Temperature area: displays engineering number of the current hydro box; Timer area: displays prior operating setting value of the current hydro box.</p>
C09	Inquiry of address of wired controller	01, 02	Timer area: displays address of the wired controller
C11	Quantity inquiry for one wired controller controls multiple indoor units (including hydro box) at the same time	1-16	Timer area: displays the quantity of indoor units (hydro box) controlled by wired controller.
C12	Outdoor ambient temperature inquiry	-	Timer area: displays ambient temperature of master outdoor unit

GMV5 Home DC Inverter Multi VRF Units

C18	Engineering number inquiry for indoor unit (hydro box) of communication network	1~255	<p>Operating method: enter into the inquiry, under “C18” status, press “Mode” button to start engineering number inquiry of hydro box, the wired controller will enter into hydro box engineering number inquiry interface, press “▲” or “▼” to switch engineering number of hydro box.</p> <p>Display mode:</p> <p>Temperature area: displays serial number of the current hydro box;</p> <p>Timer area: displays engineering number of hydro box.</p> <p>Notes:</p> <p>① When turning on the engineering number inquiry for hydro box function, the timer area of wired controllers of the whole system network will display engineering number of hydro box controlled by each wired controller (if one wired controller controls multiple hydro boxes at the same time, it will display engineering number of different hydro boxes with an interval of 3 seconds);</p> <p>② Secondary wired controller cannot turn on or cancel the engineering number inquiry for hydro box</p> <p>Cancel method:</p> <p>① If user quit the “C18” inquiry interface manually, it will immediately cancel the inquiry;</p> <p>② If there is no operation for 20 minutes and it quits “C18” inquiry interface, press “ON/OFF” button under power-on or power-off status to cancel this function;</p> <p>③ After the function is started, use either one of wired controller in the same system network and press “ON/OFF” button under power-on or power-off status of unit can quit this function.</p>
C21	Inquiry of hot water temperature	0 ~ 100℃	<p>Operating method:</p> <p>Enter into the inquiry, under “C21” status, press “Mode” button to enter into water tank temperature inquiry interface, press “▲” or “▼” to switch engineering number of hot water generator.</p> <p>Display mode:</p> <p>Display of temperature area: engineering number of the current hydro box</p> <p>Display of timer area: hot water temperature of the current hydro box</p>

Notes:

Under parameter inquiry status, the buttons “function”, “timer”, “heating water/air conditioner/floor heating” are invalid.

User parameter setting

User parameter can be set under power-on or power-off status.

1. Press and hold “Function” button for five seconds, the temperature area displays “C00”, and then press and hold “Function” button for five seconds to enter into parameter setting interface of wired controller, then the temperature area displays “P00”.

2. Press “▲” or “▼” button can select parameter code, press “Mode” button to switch to

GMV5 Home DC Inverter Multi VRF Units

parameter setting, then the parameter flickers, press “▲” or “▼” can adjust parameter value, and then press “Confirm/Cancel” button to complete the setting.

3. Press “Enter/Cancel” button can return to the upper level till quit the parameter setting.

User parameter setting list is as below:

User Parameter Setting List

Parameter Code	Parameter Name	Parameter Range	Default Value	Remarks
P13	Wired controller address settings	01: master wired controller 02: slave wired controller	01	When the two wired controllers simultaneously control one or more IDUs, the two wired controllers should use different addresses. The slave wired controller (address: 02) does not have the unit parameter setting function except its own address settings.
P14	Group-controlled IDU (hydro box) quantity settings	00: disabled 01-03: quantity of hydro box	01	This value is set according to the quantity of connected hydro box.
P43	Preferential operation settings	00: common operation 01: preferential operation	00	When power supply is insufficient, users are allowed to power on/off the hydro box with preferential operation and other hydro boxes are forcibly powered off.
P46	Whether the water tank standby thermal insulating function is allowed	00: allowed 01: not allowed	00	
P47	Water tank standby thermal insulating function temperature setting value	35 ~ 46°C	42°C	
P50	Sunflower thermal insulating water temperature setting	35 ~ 50°C	40°C	
P53	Hot water temperature auto setting revision value	-2 ~ 8°C	0°C	
P54	High temperature sterilization circulating days	0 ~ 60	0	When it sets as 0, the high temperature sterilization function setting is valid in the next time.
P55	High temperature sterilization advanced startup time	0~3 hours	1	
P56	Whether the hot water auxiliary	00: allowed 01: not allowed	00	

GMV5 Home DC Inverter Multi VRF Units

	heating is turned on in normal operation			
P58	Whether the auto heat recovery is allowed	00: allowed 01: not allowed	00	
P59	Auto heat recovery water temperature setting	35 ~ 46°C	42°C	
P73	Whether the fast heating mode is allowed	00: allowed 01: not allowed	01	
P80	Whether floor heating auxiliary heating is allowed to start up	00: allowed 01: not allowed	00	
P81	Maximum setting value of floor heating water yielding temperature	40~52°C	45°C	

Notes:

Under parameter setting status, “heating water/air conditioner/floor heating”, and “Timer” buttons are invalid. By pressing the “ON/OFF” button, users can return to the main interface but will not turn on/off the unit.

Engineering parameter inquiry

Engineering parameters can be inquired in power-on or power-off status.

- 1) Press and hold “Function” button for five seconds to enter into engineering parameter inquiry interface. The temperature area displays “C00”, and “View” icon is on;
 - 2) Within five seconds after “C00” is displayed, continuously press the “Mode” button for three times in an interval within one second to enter into engineering parameter inquiry.
 - 3) Select a parameter code by pressing “▲” or “▼”.
 - 4) Press “Enter/Cancel” button to return to the upper level menu till quitting parameter inquiry.
- In the engineering parameter inquiry interface, users can also inquire user parameters.

The engineering parameter inquiry list is as below:

Engineering Parameter Inquiry List

Parameter Code	Parameter Name	Parameter Range	View Method
C00	Parameter setting ingress	-	Under “C00” status, timer area displays the engineering number of the current hydro box, when one wired controller controls multiple hydro boxes at the same time, it will only display the engineering number of hydro box with the minimum number;
C02	Water tank capacity inquiry	150 ~3500L	Operating method: Enter into the inquiry, under “C02” status, press “Mode” button to enter into water tank capacity inquiry interface, press “▲” and “▼” to switch hydro box. Display method:

GMV5 Home DC Inverter Multi VRF Units

			<p>Display of temperature area: engineering number of the current hydro box</p> <p>Display of timer area: capacity of the current connected water tank.</p>
C05	Historical fault inquiry ingress of hydro box	Five historical faults	<p>Operating method:</p> <p>1. Enter into the inquiry, under "C05" status, press "Mode" button to enter into historical fault inquiry interface, press "▲" or "▼" button to switch engineering number of equipment. Press "Mode" button to switch serial No. of fault. Press "Enter/Cancel" button to return to the upper level.</p> <p>Display Mode:</p> <p>Temperature area: displays serial No. of fault and fault code</p> <p>Timer area: displays engineering number of equipment</p>
C10	Static pressure setting inquiry of outdoor unit	<p>00: 0Pa</p> <p>20: 20Pa</p> <p>50: 50Pa</p> <p>80: 80Pa</p>	<p>Operating method:</p> <p>Enter into the inquiry, under "C10" status, press "Mode" button to enter into static pressure setting inquiry interface of outdoor unit.</p> <p>Display mode:</p> <p>Temperature area: displays address of the current outdoor unit</p> <p>Timer area: display static pressure setting value</p>
C13	Outdoor unit network number inquiry	1~255	<p>Timer area: displays network number of the current outdoor unit</p>
C14	Temperature inquiry for inlet-tube temperature sensor of hydro box	-30~138℃	<p>Operating method:</p> <p>Enter into the inquiry, under "C14" status, press "Mode" button to enter into refrigerant inlet-tube temperature sensor inquiry interface, press "▲" or "▼" button to switch engineering number of equipment.</p> <p>Display mode:</p> <p>Temperature area: displays engineering number of the current equipment</p> <p>Timer area: displays temperature</p> <p>If there is only one equipment in HBS network, then under "C14" interface, timer area will directly display the temperature.</p>
C15	Temperature inquiry for refrigerant outlet temperature sensor of hydro box	-30~138℃	<p>Operating method:</p> <p>Enter into inquiry, under "C15" status, press "Mode" button to enter into refrigerant outlet temperature sensor inquiry interface, press "▲" or "▼" button to switch engineering number of equipment.</p> <p>Display mode:</p> <p>Temperature area: displays engineering number of the current equipment</p> <p>Timer area: displays temperature</p> <p>If there is only one equipment in the HBS network, then under the "C15" interface, timer area will directly display the temperature.</p>
C16	Opening degree inquiry	0~20	<p>Operating method:</p> <p>Enter into the inquiry, under "C16" status, press "Mode" button to</p>

GMV5 Home DC Inverter Multi VRF Units

	of electronic expansion valve of hydro box		<p>enter into opening degree inquiry interface of electronic expansion valve, press “” or “” switch to switch engineering number of equipment.</p> <p>Display mode:</p> <p>Temperature area: displays engineering number of the current equipment.</p> <p>Timer area: display the opening degree</p> <p>If there is only one equipment in the HBS network, then under the “C16” interface, timer area will directly display opening degree of electronic expansion valve.</p>
C19	Temperature inquiry for water inlet temperature sensor of hydro box	-30~138℃	<p>Operating method:</p> <p>Enter into inquiry, under the “C19” status, press “Mode” button to enter into water inlet temperature sensor temperature inquiry interface, press “” or “” button to switch engineering number of equipment.</p> <p>Display mode:</p> <p>Temperature area: display engineering number of the current equipment</p> <p>Timer area: displays the temperature</p> <p>If there is only one equipment in the HBS network, then under the “C19” interface, timer area will directly display the temperature.</p>
C20	Temperature inquiry for water outlet temperature sensor of hydro box	-30~138℃	<p>Operating method:</p> <p>Enter into the inquiry, under the “C20” status, press “Mode” button to enter into water outlet temperature sensor temperature inquiry interface, press “” or “” button to switch engineering number of equipmet.</p> <p>Display mode:</p> <p>Temperature area: displays engineering number of the current equipment</p> <p>Timer area: displays temperature</p> <p>If there is only one equipment in the HBS network, then under the “C20” interface, timer area will directly display the temperature.</p>
n2	Capacity configuration ratio upper-limit of indoor/outdoor unit	<p>35:135%</p> <p>50:150%</p> <p>10: 110%</p>	<p>Temperature area: displays parameter code</p> <p>Timer area: displays setting value of capacity configuration ratio of the current indoor and outdoor units</p>
n6	Historical fault inquiry ingress of outdoor unit	Five historical faults	<p>Operating method:</p> <p>Enter into the inquiry, under the “n6” status, press “Mode” button to enter into outdoor unit fault code inquiry (when one wired controller controls multiple indoor units at the same time, it can only inquire the memorized fault with the minimum engineering number), press “” or “” button to switch serial number of fault. Press “Enter/Cancel” button to return to the upper level status.</p> <p>Display mode:</p>

GMV5 Home DC Inverter Multi VRF Units

			<p>Temperature area: displays serial number of fault and fault code (displays from left to right) (1~5, sorting order of faults are from old to new).</p> <p>Timer area: displays engineering number of outdoor unit.</p>																																							
n7	Parameter inquiry ingress of outdoor unit	01~13 25~29	<p>Operating method (n7 inquiry is not supported for the slave wired controller):</p> <p>Under the “n7” status, the timer area will not display. Press “Mode” button to enter into parameter inquiry of outdoor unit, the first bit in the temperature area (display bit of the outdoor unit module ID) flickers. Press “▲” and “▼” to switch the outdoor unit module ID. Press the “Mode” button to select an outdoor unit module. In this case, the first bit in the temperature area stops flickering, and the second and third bits in the temperature area display the parameter code. The timer area displays a corresponding parameter. Press “” or “” to switch the parameter code, and press “Enter/Cancel” button to return to the upper level menu.</p> <p>Display mode:</p> <p>Temperature area: displays module ID of outdoor unit and parameter code from left to right.</p> <p>Timer area: displays corresponding parameter to the right.</p> <table border="1"> <thead> <tr> <th>Parameter Code</th> <th>Parameter Name</th> <th>Unit</th> </tr> </thead> <tbody> <tr> <td>01</td> <td>Outdoor ambient temperature</td> <td>°C/°F</td> </tr> <tr> <td>02</td> <td>Operating frequency of compressor 1</td> <td>Hz</td> </tr> <tr> <td>03</td> <td>Operating frequency of compressor 2</td> <td>Hz</td> </tr> <tr> <td>04</td> <td>Operating frequency of outdoor fan</td> <td>Hz</td> </tr> <tr> <td>05</td> <td>High pressure of outdoor unit</td> <td>°C/°F</td> </tr> <tr> <td>06</td> <td>Low pressure of outdoor unit</td> <td>°C/°F</td> </tr> <tr> <td>07</td> <td>Discharge temperature of compressor 1</td> <td>°C/°F</td> </tr> <tr> <td>08</td> <td>Discharge temperature of compressor 2</td> <td>°C/°F</td> </tr> <tr> <td>09</td> <td>Discharge temperature of compressor 3</td> <td>°C/°F</td> </tr> <tr> <td>10</td> <td>Discharge temperature of compressor 4</td> <td>°C/°F</td> </tr> <tr> <td>11</td> <td>Discharge temperature of compressor 5</td> <td>°C/°F</td> </tr> <tr> <td>12</td> <td>Discharge temperature of compressor 6</td> <td>°C/°F</td> </tr> </tbody> </table>	Parameter Code	Parameter Name	Unit	01	Outdoor ambient temperature	°C/°F	02	Operating frequency of compressor 1	Hz	03	Operating frequency of compressor 2	Hz	04	Operating frequency of outdoor fan	Hz	05	High pressure of outdoor unit	°C/°F	06	Low pressure of outdoor unit	°C/°F	07	Discharge temperature of compressor 1	°C/°F	08	Discharge temperature of compressor 2	°C/°F	09	Discharge temperature of compressor 3	°C/°F	10	Discharge temperature of compressor 4	°C/°F	11	Discharge temperature of compressor 5	°C/°F	12	Discharge temperature of compressor 6	°C/°F
Parameter Code	Parameter Name	Unit																																								
01	Outdoor ambient temperature	°C/°F																																								
02	Operating frequency of compressor 1	Hz																																								
03	Operating frequency of compressor 2	Hz																																								
04	Operating frequency of outdoor fan	Hz																																								
05	High pressure of outdoor unit	°C/°F																																								
06	Low pressure of outdoor unit	°C/°F																																								
07	Discharge temperature of compressor 1	°C/°F																																								
08	Discharge temperature of compressor 2	°C/°F																																								
09	Discharge temperature of compressor 3	°C/°F																																								
10	Discharge temperature of compressor 4	°C/°F																																								
11	Discharge temperature of compressor 5	°C/°F																																								
12	Discharge temperature of compressor 6	°C/°F																																								

GMV5 Home DC Inverter Multi VRF Units

				13	Operating frequency of compressor 3	Hz
				25	Outdoor unit heating EXV1 (Actual value = displayed value*10)	PLS
				26	Outdoor unit heating EXV2 (Actual value = displayed value*10)	PLS
				27	Subcooler EXV (Actual value = displayed value*10)	PLS
				28	Defrosting temperature	°C/°F
				29	Liquid-extracting temperature of subcooler	°C/°F
				30	Outlet temperature of steam separator	°C/°F
				31	Oil returning temperature	°C/°F
				32	Inlet-tube temperature of condenser	°C/°F
				33	Outlet-tube temperature of condenser	°C/°F
A6	Cooling/heating function of the entire unit	nA: cooling/heating nC: cooling only nH: heating only nF: air supply	Temperature area: displays parameter code Timer area: displays setting value of cooling/heating function of the current unit			
nb	Barcode inquiry of hydro box	0~9, A~Z, a~z,-	Operating method (nb inquiry is not supported for the slave wired controller) Under the “nb” status, timer area will display nothing. Press “Mode” button to enter into barcode inquiry, the temperature area displays “nb”, and engineering number in timer area flickers. Press “▲” and “▲” button to switch engineering number of indoor unit. Press “Mode” button to select an indoor unit, then the temperature area displays “Un”, timer area displays “-n”, press “” and “” buttons to display barcode of indoor unit and barcode of controller of indoor unit. Press “Enter/Cancel” button to return to the upper level status, the temperature area will display “nb”, and timer area will display the engineering number of indoor unit to be inquired. Press “Enter/Cancel” button again to return to the upper level. Display mode: Temperature area: nb/Un/Pc/Barcode. Timer area: -n/engineering number/barcode			

GMV5 Home DC Inverter Multi VRF Units

The following are examples:				
Example	Temperature area	Timer area	Remarks 1	Remarks
Barcode of the entire indoor unit N1r0128150066	Un (display to the right)	-n (display in the middle)	It indicates that the following is the barcode of the entire indoor unit	Press “▼” to display downward and press “▲” to display upward
	N1r	0128	It indicates the former seven bits of the barcode	
	150	066	It indicates the latter six bits of the barcode	
Barcode of controller of indoor unit N1r0128150067	Pc	-n	It indicates that the following is the barcode of controller of indoor unit	
	N1r	0128	It indicates the former seven bits of the barcode	
	150	067	It indicates the latter six bits of the barcode	
<p>Notes:</p> <ol style="list-style-type: none"> 1. Un indicates the barcode of the entire indoor unit; Pc indicates the barcode of controller of indoor unit; 2. When there is only one indoor unit, press “Mode” button under “nb” status to directly enter into barcode inquiry without selecting the engineering number of indoor unit; 3. The system will quit the inquiry status if there is no operation within 60 seconds. 				

GMV5 Home DC Inverter Multi VRF Units

			4. The barcode inquiry starts from barcode of the entire indoor unit and ends at the controller bar code of indoor unit without circulation. That is, the inquiry will not start again even if users press “▼”.
--	--	--	---

Notes:

Under parameter inquiry status, “Function”, “Timer”, “Heating water/Floor heating” buttons are invalid. Press “ON/OFF” button can return to the main interface but will not turn on/off the unit.

Engineering Parameter Settings

Engineering parameters can be set under power-on or power-off status of unit.

1) Press and hold “Function” button for five seconds, temperature area will display “C00”. Continuously press “Mode” button for three times, and then press and hold “Function” button for five seconds to enter into engineering parameter setting interface, then the temperature area will display “P00”.

2) Press “▲” or “▼” button can select parameter code, press “Mode” button to switch to parameter setting. Then the parameter flickers, press “▲” or “▼” button can adjust the parameter. Press “Enter/Cancel” button to complete settings.

3) Press “Enter/Cancel” button can return to the upper level till quitting parameter setting.

Under the engineering parameter setting interface, users can also set user parameters.

The engineering parameter setting list is as below:

Engineering Parameter Setting List

Parameter Code	Parameter Name	Parameter Range	Default Value	Remarks
P15	Power-fail memory mode	00: standby after power-fail recovery 01: restoring the original status after power-fail recovery	00	
P17	Historical fault clearing of indoor unit	00: not cleared 01: cleared	00	Historical faults of all indoor units controlled by the current wired controller are cleared.
P35	Factory setting recovery of user functions	00: invalid 01: valid	00	After selecting 01, press and hold “Enter/Cancel” button to resumes to the factory settings for user functions (factory setting recovery fails if remote shielding is valid).
P36	Factory setting recovery of engineering settings	00: invalid 01: valid	00	After selecting 01, press and hold “Enter/Cancel” button to resumes to the factory status for engineering settings (factory setting recovery fails if remote shielding is valid).
P42	Engineering number settings of hydro box	1~255	Automatically generated when the system operates initially	Under “P42” status, press “Mode” button to enter into setting menu. The engineering number in timer area will flicker, press “▲” or “▼” button to adjust engineering number. Press “Enter/Cancel” button to confirm the setting and return to the upper level menu.
P45	One-key engineering	00: invalid 01: valid	00	When it is set to be 01, the wired controller initiates an project

GMV5 Home DC Inverter Multi VRF Units

	number reset of hydro box			number reset command.
P48	Preferencial setting of system	00: No 01: air conditioner takes priority 02: heating water takes priority 03: floor heating takes priority	00	
P49	Highest hot water temperature setting of water tank	55~70℃	55℃	
P51	Highest water temperature automatically set by hydro box	50~maximum setting hot water temperature	55℃	P51 parameter value is larger than P52 parameter value;
P52	Lowest water temperatyre automatically set by hydro box	40~52℃	48℃	
P57	Whether auxiliary heating of hot water is allowed to open when the outdoor unit closes down	00: allowed; 01: not allowed;	00	
P60	Setting for capacity of water tank	150~3500L	300L	
P62	Preset deferring time	1~4h	2h	
P63	Preset time revision value	0~3h	1	
P64	Time interval when water returning pump starts up	0.5~10h	2	
P65	Operating time of water returning pump	1~10min	2	
P72	Floor heating capacity setting of hydro box	05~45kw	The same as name plate of hydro box	The maximum value can only be set to the nominal value in name plate of hydro box

GMV5 Home DC Inverter Multi VRF Units

P74	Highest water outlet temperature automatically set by floor heating	25~Maximum setting value of water outlet temperature of floor heating	45℃	
P75	Lowest water outlet temperature automatically set by floor heating	25~ Maximum setting value of water outlet temperature of floor heating	35℃	
P76	Automatically setting revision value of floor heating water temperature	-2~8℃	0℃	
P77	Highest notch B of water pump of hydro box	5~10	10	
P78	Lowest notch A of hydro box	3~10	5	
P79	Setting of corresponding engineering number of indoor unit for shunt valve	1~255	No	<p>Operating method:</p> <p>Press “Mode” button to enter into selection menu of hydro box, press “▲” and “▼” button to switch serial number of hydro box;</p> <p>Press “Mode” button to enter into shunt valve selection menu, press “▲” and “▼” to switch serial number of shunt valve;</p> <p>Press “Mode” button to enter into selection menu of indoor unit, the engineering number in timer area flickers, press “▲” and “▼” to adjust engineering number; press and hold the button within 5 seconds, the unit digit of engineering number will increase/decrease; press and hold the button for 5~10 seconds, the tens digit of engineering number will increase/decrease. Press “Enter/Cancel” button can return to the upper level status.</p> <p>Display mode:</p> <p>Temperature area: displays serial</p>

GMV5 Home DC Inverter Multi VRF Units

				<p>number of hydro box – serial number of shunt valve;</p> <p>Timer area: engineering number is on/flickering, the “number” is on.</p> <p>Notes:</p> <p>When there is only one hydro box in the HBS network, skip over the selection of hydro box and set directly from serial number of shunt valve;</p> <p>If there is no corresponding setting in P79, then the corresponding indoor unit engineering number of shunt valve are all 0, which deems that the P79 setting is invalid.</p> <p>Multiple shunt valves are allowed to match with the same indoor unit (engineering number), but the same shunt valve is not allowed to match with multiple indoor unit (engineering number);</p> <p>In the same HBS network, if corresponding relation setting between one shunt valve and indoor unit is valid, then the linkage setting between indoor unit and shunt valve is deemed valid;</p>
n0	System conservation operation settings	<p>00: comfortability preferred</p> <p>01: conservation preferred</p>	00	
n1	Defrosting period settings	<p>40: 40 minutes</p> <p>50: 50 minutes</p> <p>60: 60 minutes</p>	50	
n3	Forcible defrosting	<p>00: common</p> <p>01: forcible defrosting</p>		After setting, it will automatically resumes to 00.
n4	Highest capacity output limitation settings for outdoor unit	<p>08: 80%</p> <p>09: 90%</p> <p>10: 100%</p>	10	Enter into the inquiry under “n4” status, temperature area displays function code and timer area displays corresponding function setting value.
A7	Silent function of outdoor unit	<p>00: no silent function</p> <p>01~09: intelligent night-time silent mode from mode 1 to mode 9</p> <p>10~12: forcible silent</p>	10	Enter into the inquiry under “A7” status, temperature area displays function code, and timer area displays corresponding function setting value.

GMV5 Home DC Inverter Multi VRF Units

		mode from mode 1 to mode 3		
--	--	-------------------------------	--	--

Notes:

Under parameter setting status, “heating water/air conditioner/floor heating” and “timer” buttons are invalid. By pressing “ON/OFF” button, users can return to the main interface but will not turn on/off the unit.

Failure Display

When a fault occurs during operation of system, temperature area of wired controller will display fault code. When multiple faults occur, the fault codes will be displayed circularly.

When a fault occurs, please turn off the unit and ask for professional maintenance personnel for help.

The following figure shows that under power-on status of unit and one wired controller controls multiple units, the fault interface of inconsistent quantity of hydro boxes.



Chapter 5 Maintenance

1. Table of Error Codes

Content symbol Distinctive symbol		0	1	2	3	4	5
Indoor	L	Indoor unit fault	Indoor fan protection	Auxiliary heating protection	Water overflow protection	Power supply overcurrent protection	Anti-freezing protection
	d		Indoor unit PCB fault	Lower water temperature sensor of water tank is faulted	Ambient temperature sensor fault	Intake temperature sensor fault	Middle temperature sensor fault
	y						
Outdoor	E	Outdoor unit fault	High pressure protection	Low exhaust temperature protection	Low pressure protection	High exhaust temperature protection for compressor	
	F	Outdoor unit main board fault	High pressure sensor fault		Low pressure sensor fault		Compressor 1 exhaust temperature sensor fault
	J	Other module protection	Overcurrent protection for compressor 1	Overcurrent protection for compressor 2	Overcurrent protection for compressor 3	Overcurrent protection for compressor 4	Overcurrent protection for compressor 5
	b		Outdoor ambient temperature sensor fault	Defrosting temperature sensor 1 fault	Defrosting temperature sensor 2 fault	Subcooler outflow temperature sensor fault	Subcooler exhaust temperature sensor fault
	P	Compressor driver board fault	Compressor driver board failure	Compressor driver board power voltage protection	Compressor drive module reset protection	Compressor drive PFC protection	Inverter compressor overcurrent protection
	H	Fan driver board fault	Fan driver board failure	Fan driver board power voltage protection	Fan drive module reset protection	Fan drive PFC protection	Inverter fan overcurrent protection
Commissioning	U	Deficient preheating of the compressor		Wrong ODU capacity code/jumper cap setting	Power phase sequence protection	Refrigerant shortage protection	Wrong compressor drive board address
	C	Communication malfunction between indoor unit and outdoor unit, indoor units wires control		Communication malfunction between main control and inverter compressor driver	Communication malfunction between main control and inverter fan driver	Malfunction of lacking of indoor unit	Project series NoI of indoor unit is in conflict
Status	A	The unit is not commissioned		Aftersales refrigerant recycling	Defrosting	Oil recycling	

GMV5 Home DC Inverter Multi VRF Units

	n	Economic mode setting			Compulsory defrosting	Maximum output capacity limit setting	Compulsory indoor unit project number shift
--	---	-----------------------	--	--	-----------------------	---------------------------------------	---

Content symbol Distinctive symbol		6	7	8	9	A	H
Indoor	L	Mode conflict	No master IDU	Power supply shortage	Inconsistent number of multi-split IDUs	Inconsistent series of multi-split IDUs	Warning about poor air quality
	d	Exhaust temperature sensor fault	Humidity sensor fault	Water temperature sensor fault	Jumper cap fault	Indoor unit network address exception	Wired controller PCB exception
	y						
Outdoor	E						
	F	High exhaust temperature protection for compressor 2	High exhaust temperature protection for compressor 3	High exhaust temperature protection for compressor 4	High exhaust temperature protection for compressor 5	High exhaust temperature protection for compressor 6	Current sensor fault for compressor 1
	J	Overcurrent protection for compressor 6	Four-way valve leakage protection	High system pressure ratio protection	Low system pressure ratio protection	Exceptional pressure protection	
	b	Air intake temperature sensor 1 fault	Air outlet temperature sensor fault(outlet tube A)	Outdoor humidity sensor fault	Heat exchanger exhaust temperature sensor fault	Oil return temperature sensor fault	System clock exception
	P	Compressor drive IPM module protection	Compressor drive temperature sensor fault	Compressor drive IPM over-temperature protection	Inverter compressor out-of-step protection	Compressor drive storage chip fault	Compressor DC bus high voltage protection
	H	Fan drive IPM module protection	Fan drive temperature sensor fault	Fan drive IPM over-temperature protection	Inverter fan out-of-step protection	Inverter fan drive storage chip fault	Fan drive DC bus high voltage protection

Content symbol Distinctive symbol		6	7	8	9	A	H
Commissioning	U	Valve exception warning		Indoor unit pipeline fault	Outdoor unit pipeline fault		
	C	Alarm due to inconsistent quantity of outdoor unit	Communication fault of convertor	Emergency status of compressor	Emergency status of fan	emergency status of module	Rated capacity of indoor and outdoor unit is too high
Status	A	Cooling and heating setting	Silent mode setting	Vacuum mode			heating
	n	Unit fault inquiry	Unit parameter inquiry	Indoor project No. inquiry	Indoor unit online quantity inquiry	Heat pump unit	Heating only unit

GMV5 Home DC Inverter Multi VRF Units

Content symbol Distinctive symbol		C	L	E	F	J	P
Indoor	L	Mismatching indoor and outdoor unit models	Waterflow switch fault	EC DC water pump revolving speed fault	Shunt valve setting fault	Functional dial switch setting fault	PG motor zero passage fault
	d	Volume dial switch setting exception	Air outlet temperature sensor fault	Indoor CO sensor fault	Upper water temperature sensor of water tank is faulted	Back water temperature sensor fault	Floor heating inlet temperature sensor fault
	y						
Outdoor	E						
	F	Compressor 2 current sensor fault	Compressor 3 current sensor fault	Compressor 4 current sensor fault	Compressor 5 current sensor fault	Compressor 6 current sensor fault	DC motor fault
	J	Water flow switch protection	Low high pressure protection	Oil returning tube is blocked	Oil returning tube is leaking		
	b	Cover temperature sensor falling protection for compressor 1	Cover temperature sensor falling protection for compressor 2	Inlet temperature sensor of condenser fault	Outlet temperature sensor of condenser fault	High pressure sensor and low pressure sensor are reversely connected	Oil returning 2 temperature sensor fault
	P	Compressor drive current detection circuit fault	Compressor drive DC bus low voltage protection	Inverter compressor out-of-phase protection	Compressor drive recharging circuit fault	Inverter compressor startup failure	Inverter compressor AC current protection
	H	Fan drive current detection circuit fault	Fan driv DC bus low voltage protection	Inverter fan out-of-phase protection	Fan drive recharging circuit fault	Inverter fan startup failure	Inverter fan AC current protection
Commissioning	U	Master IDU is set	Wrong compressor emergency operational dial switch	Invalid refrigerant injection			
	C	No main control unit fault	Rated capacity of indoor and outdoor unit is too low		Malfunction of multi main control unit	Dial switch of system address is in conflict	Malfunction of multi main wired controller
Status	A	Cooling	Auto refrigerant charging	Manual refrigerant charging	Air supply	Filter cleaning reminder	Unit startup commissioning confirmation
	n	Cooling only unit		Negative code	Air supply model	Anti-high temperature in heating	

Content symbol Distinctive symbol		U	b	d	n	y
Indoor	L					
	d	Floor heating water-out temperature sensor fault	Commissioning status of unit	Solar energy temperature sensor fault	Swing parts fault	
	y					

GMV5 Home DC Inverter Multi VRF Units

Outdoor	E					
	F	Compressor 1 cover temperature sensor fault	Compressor 2 cover temperature sensor fault			
	J					
	b	Oil returning 3 temperature sensor fault	Oil returning 4 temperature sensor fault			
	P	Inverter compressor drive AC input voltage exception protection				
	H	Inverter compressor drive AC input voltage exception protection				
Commissioning	U					
	C	Communication malfunction between indoor unit and receiving lamp plate	Overflowing distribution of IP address			
Status	A	Long-distance emergency shutdown	Emergency shutdown	Restricted operation	Child-lock status	Shielding status
	n	Eliminate indoor unit long-distance shielding order	Barcode inquiry		Revision of length of connecting pipe for outdoor unit	

For example, when E4 is displayed on the ODU, find line E and column 4 in the above tables. The fault is shown in the intersection of the line and column: High exhaust temperature protection.

Note: Previous faults in the system can be inquired on the main board of the ODU and commissioning software. See n6 Fault Enquiry of the ODU or enquiry function of the commissioning software for the method.

2. Setting of outdoor unit noise reduction

2.1 Setting instruction

(1) Applicable models are as below:

Series	Subseries	Model
Multi VRF System	GMV Unic	GMV-S224W/A-X、GMV-S280W/A-X

(2) Setting of silent mode:

First: open the debugging window in panel of main control unit;

Second: energize the unit;

Third: shortly press SW3 button in mainboard outdoor unit, the system will enter into standby status; display of mainboard are as below:

LED1		LED2		LED3	
Functional Code	Display	Code of silent mode	Display	Current status	Display
A7	On	00	Flicker	OC	Flicker
A7	On	01	Flicker	OC	Flicker
A7	On	02	Flicker	OC	Flicker
A7	On	03	Flicker	OC	Flicker
A7	On	04	Flicker	OC	Flicker
A7	On	05	Flicker	OC	Flicker
A7	On	06	Flicker	OC	Flicker
A7	On	07	Flicker	OC	Flicker
A7	On	08	Flicker	OC	Flicker
A7	On	09	Flicker	OC	Flicker
A7	On	10	Flicker	OC	Flicker
A7	On	11	Flicker	OC	Flicker
A7	On	12	Flicker	OC	Flicker

Fourth: press UP button of SW1 and DOWN button of SW2 in mainboard of outdoor unit can select corresponding LED function, select "A7 outdoor silent mode". Display is as below:

LED1		LED2		LED3	
Functional code	Display	Functional code of outdoor unit	Display	Functional code of outdoor unit	Display
A7	Flicker	00	Flicker	00	Flicker

Shortly press SW7 in mainboard of outdoor unit, enter into "A7 outdoor silent mode" setting, after setting, the mainboard will display as below:

LED1		LED2		LED3	
Functional code	Display	Code of silent mode	Display	Current status	display
A7	On	10 (current silent setting)	Flicker	OC	Flicker

Fifth: press UP of SW1 and DOWN of SW2 can select the following corresponding silent mode.

Sixth: after selecting corresponding mode, press SW7 to confirm selected mode, corresponding display will as below:

LED1		LED2		LED3	
Functional code	Display	Code of silent code	Display	Current status	display
A7	On	00	On	OC	On
A7	On	01	On	OC	On

GMV5 Home DC Inverter Multi VRF Units

A7	On	02	On	OC	On
A7	On	03	On	OC	On
A7	On	04	On	OC	On
A7	On	05	On	OC	On
A7	On	06	On	OC	On
A7	On	07	On	OC	On
A7	On	08	On	OC	On
A7	On	09	On	OC	On
A7	On	10	On	OC	On
A7	On	11	On	OC	On
A7	On	12	On	OC	On

Press SW6 button in main control unit to return to the previous level. (Under setting status, shortly press the button to return to the previous level, after finishing setting, shortly press SW6, the unit will resume to current normal working status).

If there is no operation for consecutive 5 minutes, the unit will exit automatically and resume to the current status.

2.2 Effect of quiet mode:

Outdoor silent function is mainly for the location that requires lower noise, there are night-time auto silent mode and compulsory quiet mode.

Night-time auto silent mode will automatically estimate the highest ambient temperature in the daytime, and then it can operate in silent mode according to certain interval, so as to operate with low noise in night-time. There are 9 selections for night-time auto silent modes, as below:

Silent mode	Code	Estimate maximum temperature in daytime, X hours later will enter into silent mode	Quit the mode after operating night-time silent mode for Y hours	Noise level
Mode 1	01	6	10	Low noise mode
Mode 2	02	6	12	
Mode 3	03	8	8	
Mode 4	04	8	10	
Mode 5	05	10	8	
Mode 6	06	10	10	
Mode 7	07	4	14	
Mode 8	08	6	8	Medium and low noise mode
Mode 9	09	12	10	Ultra low noise mode

Notes: highest temperature in daytime is generally in 13:00~15:00.

Compulsory silent mode means the unit operates in low noise mode in both daytime and night-time. There are the following 3 kinds of selecting modes:

Silent mode	Code	Noise level
Mode 10	10	Low noise mode
Mode 11	11	Medium and low noise mode
Mode 12	12	Super low noise mode

Notes: after setting silent mode, capacity of system will be weakened, so please choose a balance point between noise and performance.

3. Instruction for “leaving out charging water” between generator and water tank

3.1 Description of question

When installing GMV Unic unit, after connecting circulating water pipe between hydro box (NRQD16G/A-S) and water tank, it has not charge water or drive out the air in the circulating water pipe, but charge water and drive out air in the water tank. Later in debugging, the unit will appear “water flow switch fault LL”, “high pressure protection E1”, “temperature sensor falling dU”, “water pump is damaged”, and other malfunctions.

3.2 Analysis

As shown in the following picture: the matching water tank of hydro box (NRQD16G/A-S) is “water tank with inner heat exchange coil pipe”, model of water tank is “SXVD***LCJ*/A-K”.

“Circulating water pipe” and “heat exchange coil pipe” are through, after heating the water inside “circulating water pipe” by generator, the hot water inside circulating water pipe will heat the water inside water tank via heat exchange coil pipe. So the “water inside water tank” is separated from “circulating water pipe”. “Circulating water pipe” must be independently charged with water to drive out the air.

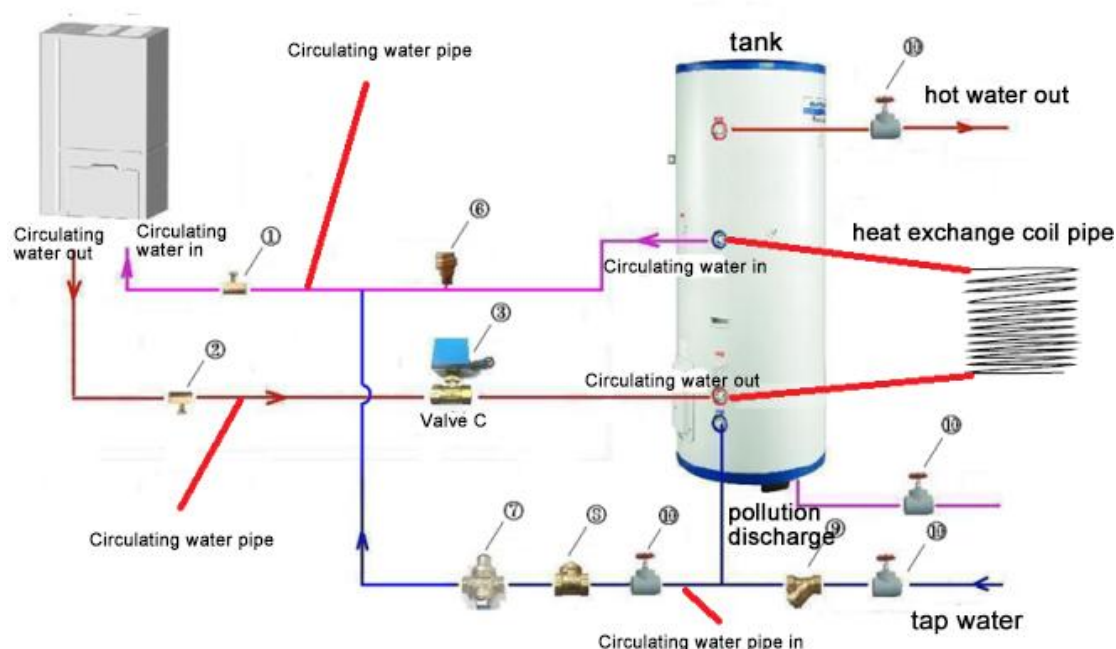

If the circulating water pipe has not been charged with water and driven out the air, then there will be no water inside the generator to conduct heat exchange with refrigerant, and then the pressure in the system will be high that will cause “high pressure protection”; water pump will be idling, and water flow switch will failure to actuate, which will lead to “water flow switch malfunction”, “water pump is damaged”; when the temperature detected by temperature sensor of generator circulating water pipe inlet and outlet is changeless, it will cause “temperature sensor falls out” and related malfunction.

3.3 Troubleshooting

When such problem arises, please charge water and drive out the air in “circulating water pipe” between generator and water tank strictly according to requirements of instruction manual. The following are related steps.

(1) Leak detection: after all the water pipelines are connected, first conduct leak detection, and then conduct heat insulation for all the water pipeline system, especially for the valves, joints of pipe. It is recommended to use heat insulating cotton with the thickness not less than 15mm.

(2) Charge water and drive out the air among generator, water tank and floor heating pipe:

A. Make sure that each water pipeline has been connected, close the air outlet valve of hot water generator, and ensure that the drain outlet has been closed;

- B. Open the water replenishing valve ⑩ to fill with water, half open the air outlet valve ①;
- C. When there is water flowing out from air outlet valve ①, completely open the air outlet valve ①;
- D. When opening air outlet valve ① and water are flowing out, energize the hydro box, and then start to drain after entering into washing mode. Operating method: under the closedown status of hydro box, long press “hot water/air conditioner/floor heating” button for 5 seconds, the “wash” icon will turn on;



- ⑤ After operating for 10 minutes, if the water flows out from air outlet valve ① is stable and without airflow, it means the air has been driven out. Then close air outlet valve ①, and stop the operation of hydro box. Operating method: long press “hot water/air conditioner/floor heating” button for 5 seconds, the washing is stopped, icon of “wash” is turned off.



- (3) Drive out the air in the pipeline between water tank and user side:
- A. Make sure that each pipeline of water tank has been connected, ensure that drain outlet of water tank is closed;
- B. Open the water replenishing valve of water tank, open water valve in user side, fill in water till there is water flowing out from water tank of user side without bubbles, it means the air has been driven out from water tank. Close water valve in user side and enter into debugging of unit.

4. Troubleshooting

4.1 Analysis in Forms

4.1.1 Control

Fault code	Fault	Possible causes	Solution
F0	Faults in the ODU's main board (such as memory and address chip exceptions)	<ol style="list-style-type: none"> 1 The clock chip on the main board is damaged. 2 The memory chip on the main board is damaged. 3 The address chip on the main board is damaged. 	<ol style="list-style-type: none"> 1 Replace the small CPU board 2 Replace the control board. 3 Replace the control board.
FC	Faults in the constant frequency compressors current sensor	<ol style="list-style-type: none"> 1 The constant frequency compressor is not started. 2 The current detection board is faulty. 3 The main boards detection circuit is faulty. 	<ol style="list-style-type: none"> 1 If the compressor is not started, check if the AC contact is closed. If not, replace the AC contact. If the connection is loose, reconnect it; 2 Replace the current detection board. 3 Replace the main board.
U2	Wrong outdoor capacity code setting	<ol style="list-style-type: none"> 1 The capacity code is wrong. 2 The dial component is faulty. 	<ol style="list-style-type: none"> 1 Modify the capacity code setting. 2 Replace the main board.
U3	Power phase sequency protection	<ol style="list-style-type: none"> 1 The three phase power cable is not connected correctly. 2 The main boards detection circuit is faulty. 	<ol style="list-style-type: none"> 1 Check connection of the power cable. 2 Replace the control board.
UL	Wrong emergency operation dial code	<ol style="list-style-type: none"> 1 The dial setting is wrong. 2 The dial component is faulty. 	<ol style="list-style-type: none"> 1 Modify the dial setting. 2 Replace the main board.
C0		1. The	If C0 is not displayed on the control board of the ODU,

GMV5 Home DC Inverter Multi VRF Units

	Communication failure between indoor and outdoor unit and indoor units wired controller	<p>communication cable is not connected.</p> <p>2. The communication cable is disconnected.</p> <p>3. The communication cable is in poor connection.</p> <p>4. The controller is faulty</p>	<p>check the network between the IDU and wired controller. If C0 is displayed, check the network between the IDUs and between the IDU and wired controller as below:</p> <p>1. Check if the cables connecting the control board of the ODU and the IDU and connecting the IDU and wired controller are loose. If they are, reconnect them;</p> <p>2. Check if the cables connecting the control board and IDU and connecting the IDU and wired controller are broken. If they are, replace the cables;</p> <p>3. Please check the contact of the communication cables;</p> <p>4. Replace the control board. If the fault is solved, the control board is faulty. Replace the IDU. If the fault is solved, it means the mainboard of indoor unit is faulty.</p>
C2	Communication failure between main control board and inverter compressor drive	<p>1. The communication cable is loose.</p> <p>2. The communication cable is disconnected.</p> <p>3. The communication cable is in poor connection.</p> <p>4. The controller is faulty.</p>	<p>1., Check if the cable connecting the control board and the compressors drive board is loose. If it is, reconnect it.</p> <p>2. Check if the cable connecting the control board and compressor's drive board is broken. If it is, replace the cable;</p> <p>3. Check the contact of the communication cable connecting the control board and compressors drive board;</p> <p>4. Replace the control board. If the fault is solved, the control board is faulty; replace the compressors drive board, if the fault is solved, it means the compressors drive board is faulty.</p>
C3	Communication failure between main control board and inverter fan drive	<p>1. The communication cable is loose.</p> <p>2. The communication cable is disconnected;</p> <p>3. The communication cable is in poor connection.</p> <p>4. The controller is faulty.</p>	<p>1. Check if the cable connecting the fans drive board and the compressors drive board is loose, if it is, reconnect it;</p> <p>2. Check if the cable connecting the fans drive board and compressors drive board is broken, if it is, replace the cable;</p> <p>3. Check the contact of the communication cable connecting the fans drive board and compressors drive board;</p> <p>4. Replace the main control board, if the fault is solved, the main control board is faulty; replace the fans drive board, if the fault is solved, the fans drive board is faulty.</p>
C5	Indoor unit project number conflict warning	1 Project numbers conflict with each other.	1 Change conflicting project numbers and ensure that no IDUs project number is repeated.
C6	Outdoor unit number inconsistency warning	<p>1. Communication cables between ODUs are loose.</p> <p>2. Communication</p>	<p>1, If the communication cable is loose, reconnect it.</p> <p>2, If the communication cable is broken, replace it;</p> <p>3 Check contact of the communication cable;</p> <p>4 Replace the main control board.</p>

GMV5 Home DC Inverter Multi VRF Units

		<p>cables between ODUs are broken.</p> <p>3. Communication cables between ODUs are in poor connection.</p> <p>4. The controller is faulty.</p>	
CC	No controlling unit	<p>SA800 The SA8 dial switch of the ODU is not switched to 00.</p> <p>SA8 The SA8 dial switch of the ODU is faulty</p>	<p>1 SA800 Switch the SA8 dial switch of one of ODU to 00;</p> <p>2 SA800 Replace the control board or switch an ODUs SA8 dial switch to 00.</p>
CF	Multiple controlling units	<p>SA800 SA8 dial switches of multiple ODUs are switched to 00.</p> <p>Dial switches of multiple ODUs are faulty.</p>	<p>1 SA800 11 Leave one SA8 dial switch unchanged, while switch all the other dial switches to 11;</p> <p>2 Replace the main control board.</p>
L7	No master IDU	<p>The master IDU is powered off.</p> <p>The communication of the master IDU fails.</p> <p>The main board of the master IDU is faulty.</p> <p>No master IDU is set in the system.</p>	<p>Check if the master IDU is powered on. If yes, replace the main board;</p> <p>C0 Check the contact of the communication cable of the master IDU. If no communication failure (C0) is reported, replace the main board.</p> <p>Replace the IDU's main board and reset the master IDU. Set the master IDU.</p>
C5	Project number conflict	Multiple IDUs share one project number	1 Reset the repeated project number

Fault code	Fault	Possible causes	Solution
------------	-------	-----------------	----------

GMV5 Home DC Inverter Multi VRF Units

C2	Communication failure between main control board and inverter compressor drive	<ol style="list-style-type: none"> 1 The control board is powered off; 2 The compressor drive board is powered off; 3 The communication cable between the control board and compressor drive board is not connected; 4 The compressor drive board's dial switch SA201 is wrong. 	<ol style="list-style-type: none"> 1 Check the power supply of the control board. Replace the control board if it works properly; 2 Check the power supply of the drive board. Replace the drive board if it works properly; 3 Connect the main board and drive board using the communication cable; 4 Adjust the dial switch of the compressor drive board.
P3	Compressor drive module reset protection	1 The compressor drive board is faulty.	1 Replace the compressor drive board.
P5	Inverter compressor over-current protection	<ol style="list-style-type: none"> 1 IPM The drive board's IPM module is damaged; 2 The compressor's UVW cable is not connected properly; 3 The compressor is damaged. 	<ol style="list-style-type: none"> 1 Replace the compressor drive board; 2 UVW Reconnect the compressor's UVW cable; 3 Replace the compressor.
P6	Compressor drive IPM module protection	<ol style="list-style-type: none"> 1 The drive board's IPM module is damaged; 2 The compressor's UVW cable is not connected properly; 3 The compressor is damaged. 	<ol style="list-style-type: none"> 1 Replace the compressor drive board; 2 Reconnect the compressor's UVW cable; 3 Replace the compressor.
P7	Compressor drive temperature sensor fault	1 The compressor drive board is faulty.	1 Replace the compressor drive board.
P8	Compressor drive IPM over-temperature protection	<ol style="list-style-type: none"> 1 The compressor drive board is faulty; 2 Thermal gel is not applied evenly on the IPM module; 3 The IPM module is not screwed properly. 	<ol style="list-style-type: none"> 1 Replace the compressor drive board; 2 Apply thermal gel evenly on the IPM module; 3 Screw the IPM module properly.
P9	Inverter compressor out-of-step protection	1 The compressor drive board is faulty.	1 Replace the compressor drive board.
PH	Compressor drive DC bus high voltage protection	<ol style="list-style-type: none"> 1 Whether the voltage of the input power cable of the whole system exceed 460 V; 2 The compressor drive board is faulty. 	<ol style="list-style-type: none"> 1 Adjust the input power voltage to the required range; 2 Replace the compressor drive board.
PL	Compressor drive DC bus low voltage protection	<ol style="list-style-type: none"> 1 Is the voltage of the input power cable of the whole system lower than 320 V; 2 The compressor drive board is faulty. 	<ol style="list-style-type: none"> 1 Elevate the voltage of the input power cable to the required range; 2 Replace the compressor drive board.
PC	Compressor drive current check circuit fault	1 The compressor drive board is faulty.	1 Replace the compressor drive board.
PF	Compressor drive recharging circuit fault	1 Is the voltage of the input power cable of the whole system lower than 280 V;	1 Elevate the voltage of the input power cable to the

GMV5 Home DC Inverter Multi VRF Units

		2 The compressor drive board is faulty.	required range; 2 Replace the compressor drive board.
PJ	Inverter compressor starting failure	1 The drive board is faulty; 2 The compressor's UVW cable is not connected properly; 3 The compressor is damaged.	1 Replace the compressor drive board; 2 Reconnect the compressor's UVW cable; 3 Replace the compressor.
C3	Communication failure between main control board and variable frequency fan drive	1 The control board is powered off; 2 The fan drive board is powered off; 3 The communication cable between the control board and fan drive board is not connected; 4 The fan drive board's dial switch is wrong.	1 Check the power supply of the control board. Replace the control board if it works properly; 2 Check the power supply of the drive board. Replace the drive board if it works properly; 3 Connect the main board and drive board using the communication cable; 4 Adjust the dial switch of the fan drive board.
H3	Fan drive module reset protection	1 The fan drive board is faulty.	1 Replace the fan drive board.
H5	Inverter fan overcurrent protection	1 The fan drive board's IPM module is damaged; 2 The fan's UVW cable is not connected properly; 3 The fan is damaged.	1 Replace the fan drive board; 2 Reconnect the fan's UVW cable; 3 Replace the fan.
H6	Fan drive IPM module protection	1 The fan drive board's IPM module is damaged; 2 The fan's UVW cable is not connected properly; 3 The fan is damaged.	1 Replace the fan drive board; 2 Reconnect the fan's UVW cable; 3 Replace the fan.
H7	Fan drive temperature sensor fault	1 The fan drive board is faulty.	1 Replace the fan drive board.
H8	Fan drive IPM over-temperature protection	1 The fan drive board is faulty; 2 Thermal gel is not applied evenly on the IPM module; 3 The IPM module is not screwed properly.	1 Replace the fan drive board; 2 Apply thermal gel evenly on the IPM module; 3 Screw the IPM module properly.
H9	Inverter fan out-of-step protection	The fan drive board is faulty.	Replace the fan drive board.
H H	Fan drive DC bus high voltage protection	1 Whether the voltage of the input power cable of the whole system exceeds 460 V; 2 The fan drive board is faulty.	1 Lower the voltage of the input power cable to the required range; 2 Replace the fan drive board.

GMV5 Home DC Inverter Multi VRF Units

HL	Fan drive DC bus low voltage protection	<p>1 Is the voltage of the input power cable of the whole system lower than 320 V;</p> <p>2 Is the fan drive board well connected with the compressor drive board;</p> <p>3 The fan drive board is faulty.</p>	<p>1 Elevate the voltage of the input power cable to the required range;</p> <p>2 Connect the fan drive board with the compressor drive board according to the wiring diagram;</p> <p>3 Replace the fan drive board.</p>
H C	Fan drive current detection circuit fault	<p>1 The fan drive board is faulty.</p>	<p>1 Replace the fan drive board.</p>
HJ		<p>1 The drive board is damaged;</p> <p>2 The fan's UVW cable is not connected properly;</p> <p>3 The fan is damaged.</p>	<p>1 Replace the fan drive board;</p> <p>2 Reconnect the fan's UVW cable;</p> <p>3 Replace the fan.</p>

4.1.2 System faults

4.1.2.1 System exhaust temperature exception

GMV5 Home DC Inverter Multi VRF Units

Fault code	Fault	Possible causes						Solution
		Primary cause		Secondary cause		Tertiary cause		
		Description	Confirmation method	Description	Confirmation method	Description	Confirmation method	
E4	High exhaust temperature protection	1.The stop valve of the ODU is not fully opened as required.	—	—	—	—	Manual check	Fully open the stop valve.
		2.The IDU's electronic expansion valve is not working properly.	When the IDU is working in the cooling mode and the electronic expansion valve is opened to 2000PLS, the exhaust temperature of the IDU's coil is more than 15°C higher than the intake temperature; when the IDU is working in the heating mode and the electronic expansion valve is opened to 2000PLS, the intake temperature of the	2.1The controlling of electronic expansion valve by main board of indoor unit is abnormal.	Reset the IDU. Listen to the sound and touch the tube to see if the electronic expansion valve is reset. If it is set, it is normal. Otherwise, it is faulty.	2.1.1The control wire of the electronic expansion valve is not connected to the main board.	Manual check	Connect the electronic expansion valve's control wire to the main board.
						2.1.2The control wire that connects the electronic expansion valve to the main board is broken.	Manual check	Repair or replace the control wire of the electronic expansion valve.
				2.2The electronic expansion valve in the mode switcher is faulty.	Other reasons	2.2.1Affected by impurities in the system		Clean the system and clear the impurities. Replace the body of the electronic

GMV5 Home DC Inverter Multi VRF Units

			IDU's coil is more than 10°C higher than the intake temperature;					expansion valve.
						2.2.2The valve body is faulty.		Replace the body of the electronic expansion valve.
		3.The system pipeline is blocked.	The system's exhaust temperature rises and the low pressure is too low (compared with the reference value).	3.1The fluid pipe is blocked.	Touch the pipe along the flowing direction of refrigerant to feel the temperature difference. The difference is large or part of the pipe is frosting.	—	—	Replace and solder the pipe.
				3.2The air pipe is blocked.				Replace and solder the pipe.
				3.3The pipe that connects the IDU is blocked.		Touch the pipe along the flowing direction of refrigerant to feel the temperature difference. The difference is large or part of the pipe is frosting.	3.3.1The block is caused by solder.	Cut off the pipe to see if it is blocked.
		3.3.2The pipeline is blocked by impurities.	Replace and solder the pipe.					

GMV5 Home DC Inverter Multi VRF Units

		4.Lacking refrigerant	The system's exhaust temperature rises and the low pressure is too low (compared with the reference value).	4.1 Not enough refrigerant				Inject refrigerant as required.
			4.2 Refrigerant pipe leakage		Use the refrigerant leak detector to detect the leak along the pipe.			Stop the leak. Pump out air and inject refrigerant again.
		5.Wrong refrigerant is injected.	20 Stop the whole system. Test the system's balance pressure 20 minutes later and convert the pressure into the corresponding saturation temperature. Compare it with the outdoor ambient temperature. If the difference is larger than 5°C, it is exceptional.	—	—	—	—	Discharge existing refrigerant and inject the correct refrigerant as required.
		6.Exhaust temperature sensor failure						Replace the temperature sensor or main

GMV5 Home DC Inverter Multi VRF Units

								board.
		7.The ambient temperature exceeds the scope of temperature required for safe operation.		50The outdoor ambient temperature exceeds 50C.	Measure the ambient temperature.			It is a normal phenomenon caused by the protection function.
E2	Low exhaust temperature protection	1.The ODU's electronic expansion valve is not working properly.	When the system is working in the heating mode and the ODU's electronic expansion valve is opened to 100PLS, the intake temperature of the corresponding liquid-air separator is more than 1°C lower than the low-pressure saturation temperature and the difference between the compressor's exhaust temperature or cover temperature	1.2The controlling heating electronic expansion of the main board or the electronic expansion valve of the subcooler is faulty.	Reset the ODU. Listen to the sound and touch the tube to see if the electronic expansion valve is reset. If it is set, it is normal. Otherwise, it is faulty.	1.2.1The control wire of the electronic expansion valve is not connected to the main board.	Manual check	Connect the electronic expansion valve's control wire to the main board.
					1.2.2The control wire that connects the electronic expansion valve to the main board is broken.	Manual check	Repair or replace the control wire of the electronic expansion valve.	
			1.3The body of the electronic expansion valve is not working properly.	Other reasons	1.3.1Affected by impurities in the system		Clean the system and clear the impurities. Replace the body of the electronic expansion valve.	

GMV5 Home DC Inverter Multi VRF Units

			e and the high-pressure temperature is smaller than 10°C.			1.3.2The body of the valve is faulty.		Replace the body of the electronic expansion valve.
	2.The IDU's electronic expansion valve is not working properly	When the system is working in the cooling mode and the ODU's electronic expansion valve is opened to 200PLS, the exhaust temperature of the IDU's coil is more than 1°C lower than the intake pipe's temperature and the difference between the compressor's exhaust temperature or cover temperature and the high-pressure temperature is smaller than 10°C.	2.1 The controlling of electronic expansion valve by main board of indoor unit is abnormal.	Reset the IDU. Listen to the sound and touch the tube to see if the electronic expansion valve is reset. If it is set, it is normal. Otherwise, it is faulty.	2.1.1The control wire of the electronic expansion valve is not connected to the main board.	Manual check	Connect the electronic expansion valve's control wire to the main board.	
2.1.2The control wire that connecting the electronic expansion valve to the main board is broken.					Manual check	Repair or replace the control wire of the electronic expansion valve.		
2.2 The body of the electronic expansion valve is not working properly.			Other reasons	2.2.1Affected by impurities in the system		Clean the system and clear the impurities. Replace the body of the electronic expansion valve.		
				2.2.2The valve body is faulty.		Replace the body of the electronic expansion valve.		
	3.Exhaust temperatu						Replace the	

GMV5 Home DC Inverter Multi VRF Units

		re sensor failure						temperature sensor or main board.
		4. Too much refrigerant	Other reasons	Incorrect quantity of refrigerant is injected.				Check the necessary amount of refrigerant and discharge the unneeded refrigerant slowly via the stop valve of the fluid pipe.

4.1.2.2 Pressure

Fault code	Fault	Possible causes						Solution
		Primary cause		Secondary cause		Tertiary cause		
		Description	Confirmation method	Description	Confirmation method	Description	Confirmation method	
E1	High pressure protection	1. The stop valve of the ODU is not fully opened as required.					Manual check	Fully open the stop valve.
		2. The system pipeline is blocked.	The system's exhaust pressure rises and the low pressure is too low (compared with the reference	2.1 The system air pipeline is blocked.	Touch the pipe along the flowing direction of refrigerant to feel the temperature difference. The difference is large.	2.1.1 The block is caused by solder.	Cut off the pipe and check it.	Replace and solder the pipe.
						2.1.2 The pipeline is blocked by impurities.		Replace and solder the pipe.

GMV5 Home DC Inverter Multi VRF Units

			value).	2.2The fluid pipe is blocked.	Touch the pipe along the flowing direction of refrigerant to feel the temperature difference. The difference is large or part of the pipe is frosting.			Replace and solder the pipe.
				2.4The pipe that connects the IDU is blocked.	Touch the pipe along the flowing direction of refrigerant to feel the temperature difference. The difference is large or part of the pipe is frosting.	2.4.1The block is caused by solder.	Cut off the pipe and check it.	Replace and solder the pipe.
						2.4.2The pipeline is blocked by impurities		Replace and solder the pipe.
		3.The ambient temperature is too high.		3.150In the cooling mode, the outdoor temperature is over 50C.	Measure the outdoor ambient temperature.			It is a normal phenomenon on caused by the protection function.
				3.2In the heating mode, the actual ambient temperature of the IDU's return air is over 30C.	Measure the outdoor ambient temperature.			It is a normal phenomenon on caused by the protection function.

GMV5 Home DC Inverter Multi VRF Units

				<p>4.1The high pressure sensor is faulty.</p>	<p>205 Stop the whole system. Test the system's balance pressure 20 minutes later and convert the pressure into the corresponding saturation temperature. Compare it with the outdoor ambient temperature. If the difference is larger than 5C, it is exceptional.</p>			<p>Replace the high pressure sensor.</p>
		<p>4.The pressure sensor is faulty.</p>		<p>4.2The high pressure and low pressure sensors are connected reversely.</p>	<p>Connect the stop valve of the module fluid pipe and air pipe to the high and low pressure gauges and transform the readings into corresponding temperatures. Compare them to the high- and low-temperatures tested by the system. If the difference is larger than 5C, it is exceptional.</p>			<p>Check the high and low-pressure sensors.</p>

GMV5 Home DC Inverter Multi VRF Units

						5.1.1The pressure switch is not connected to the main board.		Reconnect it.
		5.The high pressure switch is faulty.	E1 E1 protection is displayed on the unit when it is powered on.	5.1The high pressure switch is not connected to the main board.		5.1.2The connect wire between the pressure switch and main board is faulty.		Replace the connect wire.
				5.2The high pressure switch is damaged.				Replace the pressure switch.
		6.The fan is not working properly.	A. B. A. The ODU's fan does not work in the cooling mode. B. The IDU's motor does not work in the heating mode.	6.1The IDU's fan is faulty.	Manual check	6.1.1The power cable connecting the motor and main board is loose.	Manual check	Reconnect the motor with the power cable.
						6.1.2The electric capacity is not connected or is damaged	Manual check	Connect or replace the electric capacity.
						6.1.3The motor is damaged	Other reasons	Replace the motor.

GMV5 Home DC Inverter Multi VRF Units

						6.2.1The fan motor is not properly connected with the control board of the motor with the power cable.	Manual check	Reconnect it properly.
				6.2The ODU's fan is faulty.	Manual check	6.2.2The fan motor is not properly connected with the control board of the motor with the signal feedback cable.	Manual check	Reconnect it properly.
						6.2.3The control board of the fan's motor is damaged	Manual check	Replace the control board of the motor.
						6.2.4The main board of the fan's motor is damaged	Other reasons	Replace the motor.

GMV5 Home DC Inverter Multi VRF Units

		7. Too much refrigerant	Other reasons	Incorrect quantity of refrigerant is injected.				Check the necessary amount of refrigerant and discharge unneeded refrigerant slowly via the stop valve of the fluid pipe.
JL	Low high pressure protection	1. The ambient temperature exceeds the range.		1.1 The outdoor ambient temperature in the cooling mode is lower than -10C.	Measure the outdoor ambient temperature.			It is a normal phenomenon caused by the protection function.
				1.2 The indoor ambient temperature in the heating mode is lower than 5C.	Measure the temperature of the unit's return air.			It is a normal phenomenon caused by the protection function.
		2. Not enough refrigerant						Locate the leak and inject refrigerant.

Fault code	Fault	Possible causes						Solution
		Description	Confirmation method	Description	Confirmation method	Description	Confirmation method	
E3	Low pressure protection	1. The stop valve of the ODU is					Manual check	Fully open the stop valve.

GMV5 Home DC Inverter Multi VRF Units

	on	not fully opened as required.						
		2.The system pipeline is blocked.	The system's exhaust pressure rises and the low pressure is too low (compared with the reference value).	2.1The system air pipeline is blocked.	Touch the pipe along the flowing direction of refrigerant to feel the temperature difference. The difference is large.	2.1.1The block is caused by solder.	Cut off the pipe and check it.	Replace and solder the pipe.
						2.1.2The pipeline is blocked by impurities.		Replace and solder the pipe.
				2.2The fluid pipe is blocked.	Touch the pipe along the flowing direction of refrigerant to feel the temperature difference. The difference is large or part of the pipe is frosting.			Replace and solder the pipe.
				2.4The pipe that connects the IDU is blocked.	Touch the pipe along the flowing direction of refrigerant to feel the temperature difference. The difference is large or part of the pipe is frosting.	2.4.1The block is caused by solder.	Cut off the pipe and check it.	Replace and solder the pipe.
						2.4.2The pipeline is blocked by impurities.		Replace and solder the pipe.
		3.The ambient temperature is too low.		3.1The outdoor ambient temperature is lower than -25C in the	Measure the outdoor ambient temperature.			It is a normal phenomenon caused by the protection function.

GMV5 Home DC Inverter Multi VRF Units

				heating mode.				
		4.The pressure sensor is faulty.		4.1The low pressure sensor is faulty.	<p>20</p> <p>Stop the whole system.</p> <p>Test the system's balance pressure 20 minutes later and convert the pressure into the corresponding saturation temperature.</p> <p>Compare it with the outdoor ambient temperature.</p> <p>If the difference is larger than 5C, it is exceptional.</p>			Replace the high pressure sensor.
				4.2The high pressure and low pressure sensors are connected reversely.	<p>Connect the stop valves of the module high- and low-pressure air pipes to the high and low pressure gauges and transform the readings into corresponding temperatures.</p> <p>Compare them to the high- and low-temperatures tested by</p>			Reconnect the high- and low-pressure sensors.

GMV5 Home DC Inverter Multi VRF Units

					the system. If the difference is larger than 5C, it is exceptional.			
6.The fan is not working properly.	A. The IDU's fan does not work in the cooling mode. B. The ODU's fan does not work in the heating mode.	6.1The IDU's fan is faulty.	Manual check	6.1.1The power cable connecting the motor and main board is loose.	Manual check	Reconnect the motor with the power cable.		
				6.1.2The electric capacity is not connected or is damaged.	Manual check	Connect or replace the electric capacity.		
				6.1.3The motor is damaged.	Other reasons	Replace the motor.		
		6.2The ODU's fan is faulty.	Manual check	6.2.1The fan motor is not properly connected with the control board of the motor.	Manual check	Reconnect it properly.		
				6.2.2The fan motor is not properly connected with the control board of the motor with the communication feedback cable.	Manual check	Reconnect it properly.		
				6.2.3The				

GMV5 Home DC Inverter Multi VRF Units

						control board of the fan's motor is damaged.	Manual check	Replace the control board of the motor.
						6.2.4The main board of the fan's motor is damaged.	Other reasons	Replace the motor.
		7.Not enough refrigerant	Other reasons	Incorrect quantity of refrigerant is injected.				Check the necessary amount of refrigerant and inject refrigerant slowly via the stop valve of the low-pressure air pipe.

4.1.2.3/ Poor cooling/heating performance

Feedback from user	Exception	Possible causes						Solution
		Primary cause		Secondary cause		Tertiary cause		
		Description	Confirmation method	Description	Confirmation method	Description	Confirmation method	
Poor heating/cooling performance	A. When the IDU is working in the cooling mode and the electronic expansion valve is opened to 2000PLS, the exhaust temperature of the IDU's coil is more than 5C higher than the intake temperature; B. when the IDU is working in the heating mode and	1.The stop valve of the ODU is not fully opened as required.					Manual check	Fully open the stop valve.
		2.The system pipeline is blocked.		2.1The system air pipeline is blocked.	Touch the pipe along the flowing direction of refrigerant to feel the temperature difference . The difference is large.	2.1.1The block is caused by solder.	Cut off the pipe and check it.	Replace and solder the pipe.
								2.1.2The pipeline is blocked by impurities.
					2.2The fluid pipe is blocked.	Touch the pipe along the flowing		

GMV5 Home DC Inverter Multi VRF Units

	the electronic expansion valve is opened to 2PLS, the intake temperature of the IDU's coil is more than 12C lower than the saturation temperature corresponding to the high pressure;				direction of refrigerant to feel the temperature difference . The difference is large or part of the pipe is frosting.							
					2.4The pipe that connects the IDU is blocked.	Touch the pipe along the flowing direction of refrigerant to feel the temperature difference . The difference is large or part of the pipe is frosting.	2.4.1The block is caused by solder.	Cut off the pipe and check it.	Replace and solder the pipe.			
						2.4.2The pipeline is blocked by impurities.	Replace and solder the pipe.					
					3.The ambient temperature exceeds the required range.				3.1The ambient temperature of the IDU that works in the cooling mode is higher than 32C.	Measure the outdoor ambient temperature.	3.1.11 The system has worked for less than 1 hour.	It is a normal phenomenon
											3.1.2An improper system is selected	Choose another system with larger power.
									3.2The outdoor ambient temperature in the cooling mode is higher than 40C.	Measure the outdoor ambient temperature.		It is a normal phenomenon.
									3.312The ambient temperature of the IDU that works in the heating mode is lower than 12C.	Measure the outdoor ambient temperature.	3.3.12The system has worked for less than 2 hours.	It is a normal phenomenon.
					3.3.2An improper system is selected	Choose another system with larger power.						

GMV5 Home DC Inverter Multi VRF Units

				3.4-7The outdoor ambient temperature in the heating mode is lower than -7C.	Measure the outdoor ambient temperature.			It is a normal phenomenon.
		4.Poor airflow distribution design		4.1The air intake and return inlet of the ODU are too close to each other, affecting the heat exchange performance of the unit.	Check the distance.			Re-design the airflow distribution.
				4.2The air intake and return inlet of the IDU are too close to each other, causing poor heat exchange of the unit.	Check the distance.			Re-design the airflow distribution.
		7.Not enough refrigerant	Other reasons	Incorrect quantity of refrigerant is injected.				Check the necessary amount of refrigerant and inject refrigerant slowly via the stop valve of the low-pressure air pipe.

4.2Flowchart analysis

4.2.1 High exhaust temperature protection (E4)

When the system appears high exhaust temperature protection for compressor, the IDU will display high exhaust temperature fault E4, while the IDU will display the specific faulty compressor. For example, when high exhaust temperature protection is enabled on compressor 2# of module 3# of the ODU, IDUs will display E4 and the module will display E6, indicating that high exhaust temperature protection is enabled on compressor 2#.

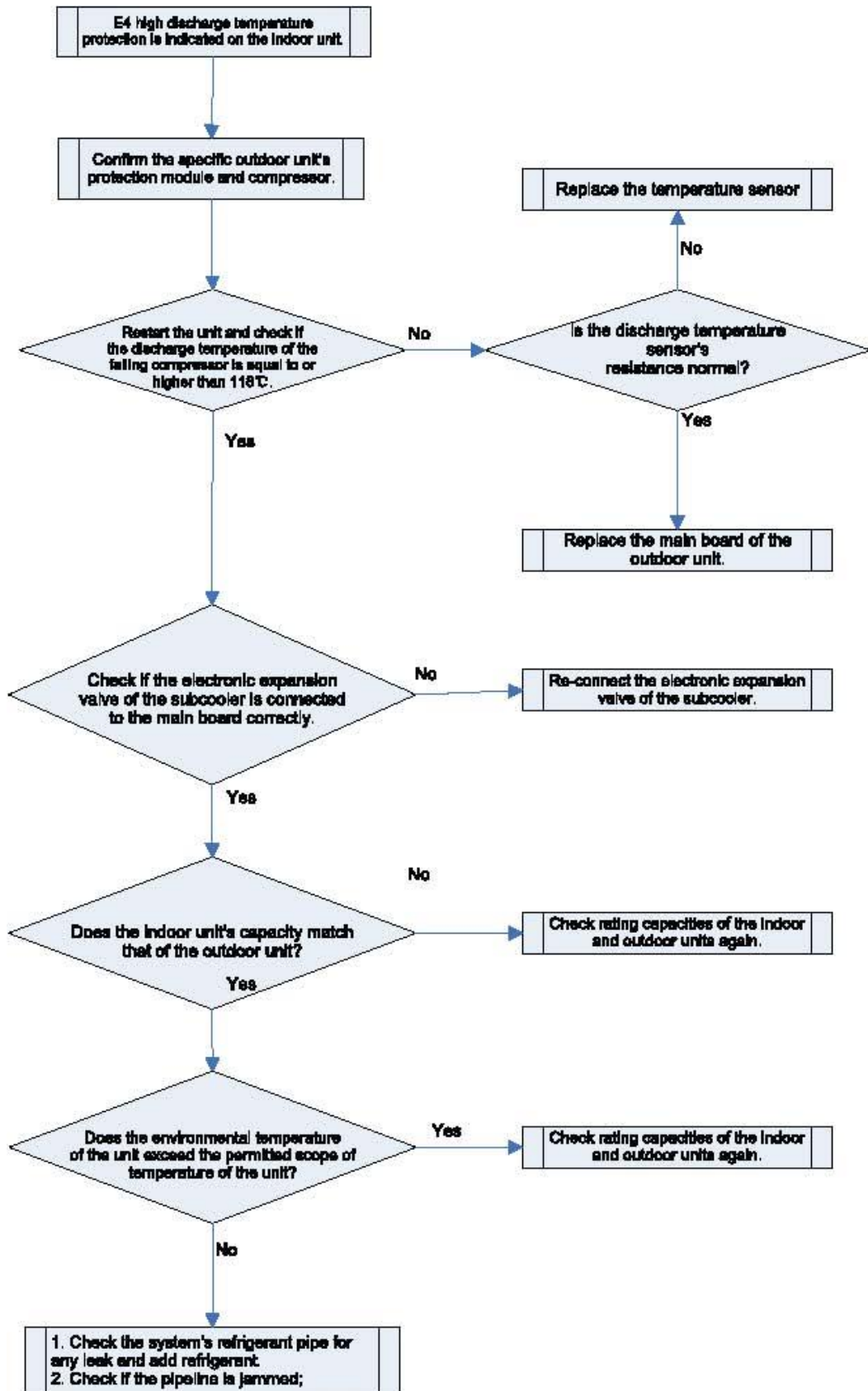

4.2.2 Low exhaust temperature protection (E2)

4.2.3 System high pressure protection (E1)

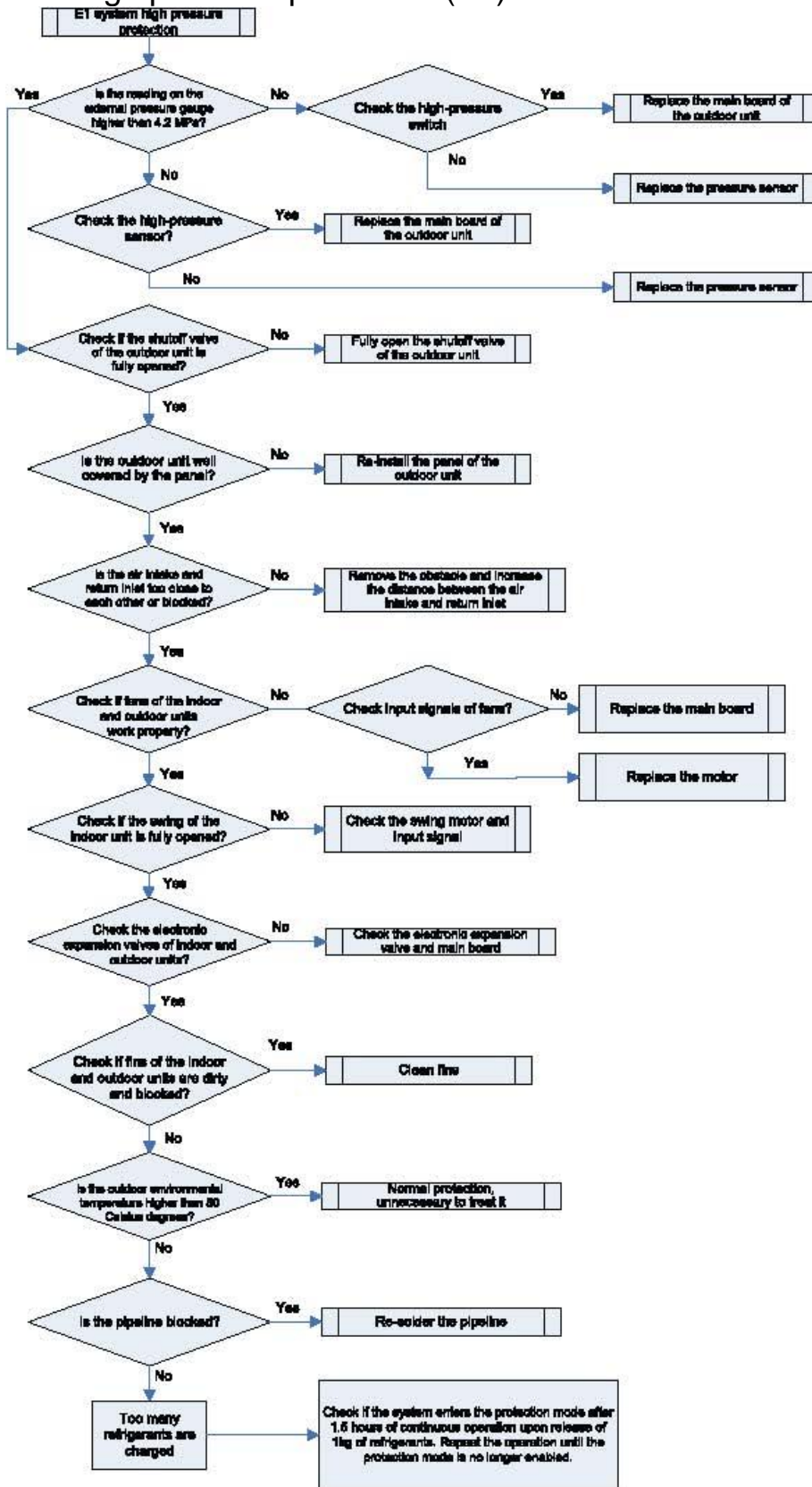

4.2.4 System low pressure protection (E3)

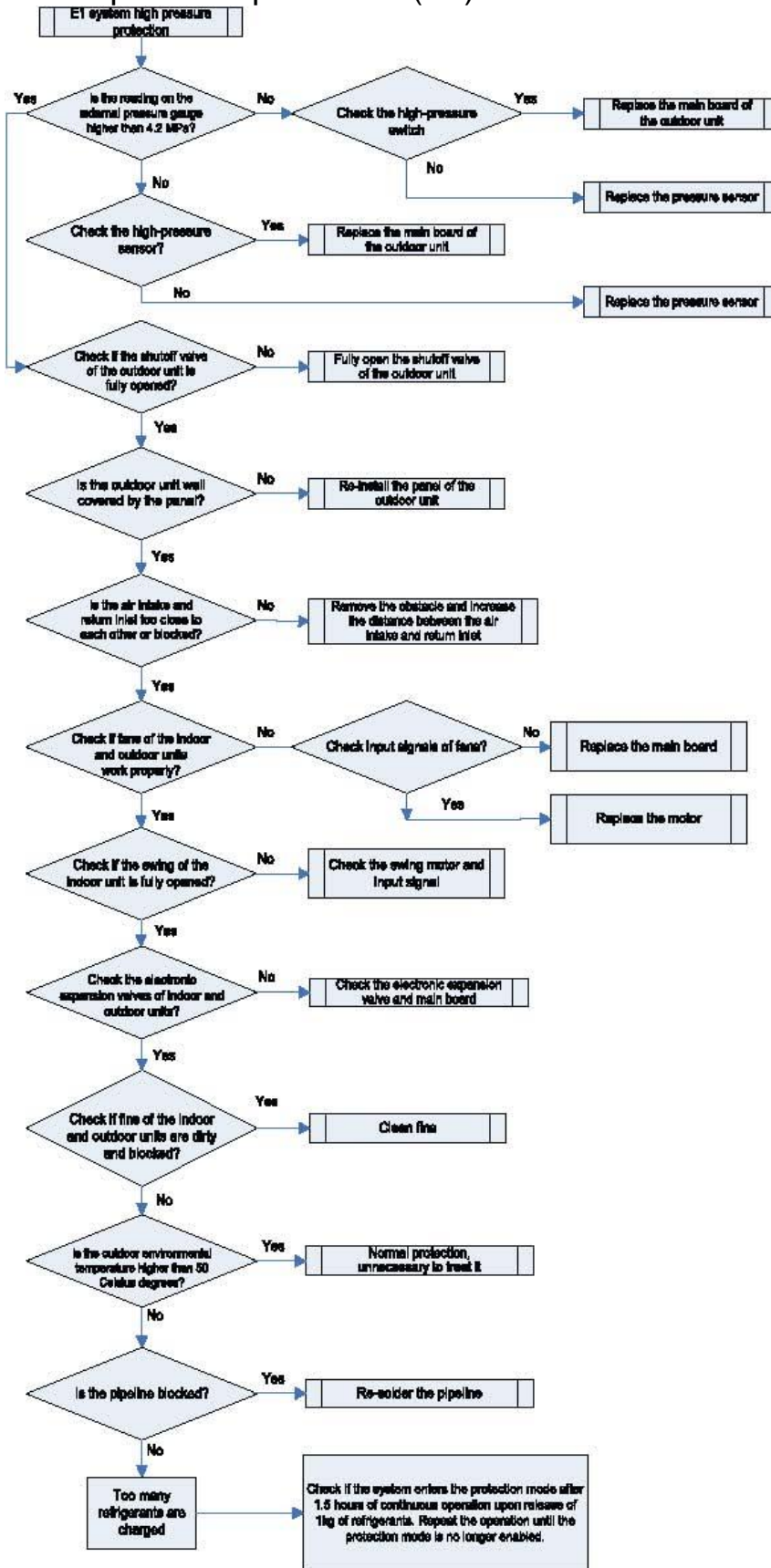

4.2.5. System refrigerant lacking protection (U4)

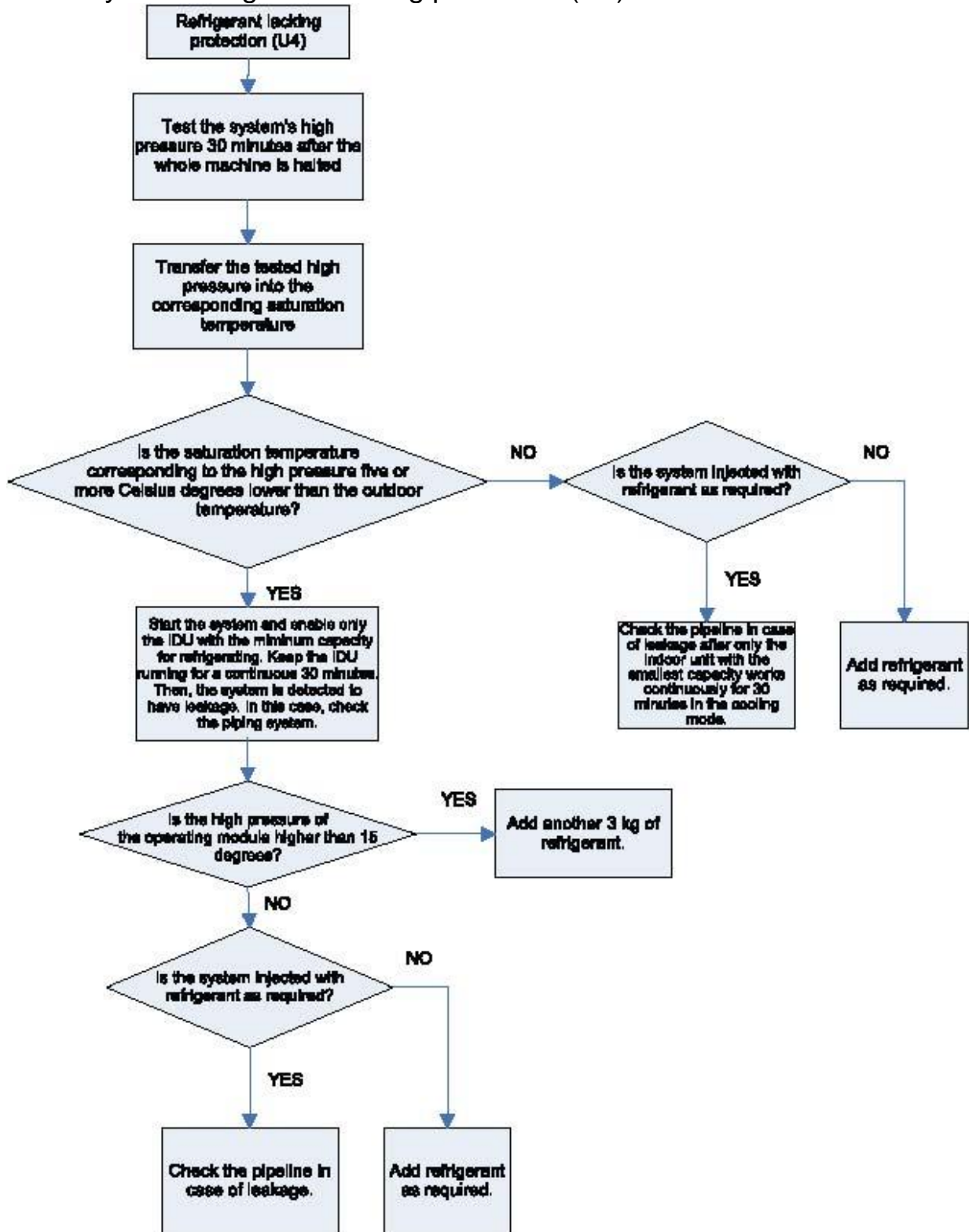

4.2.6. System high pressure ratio protection (J8)

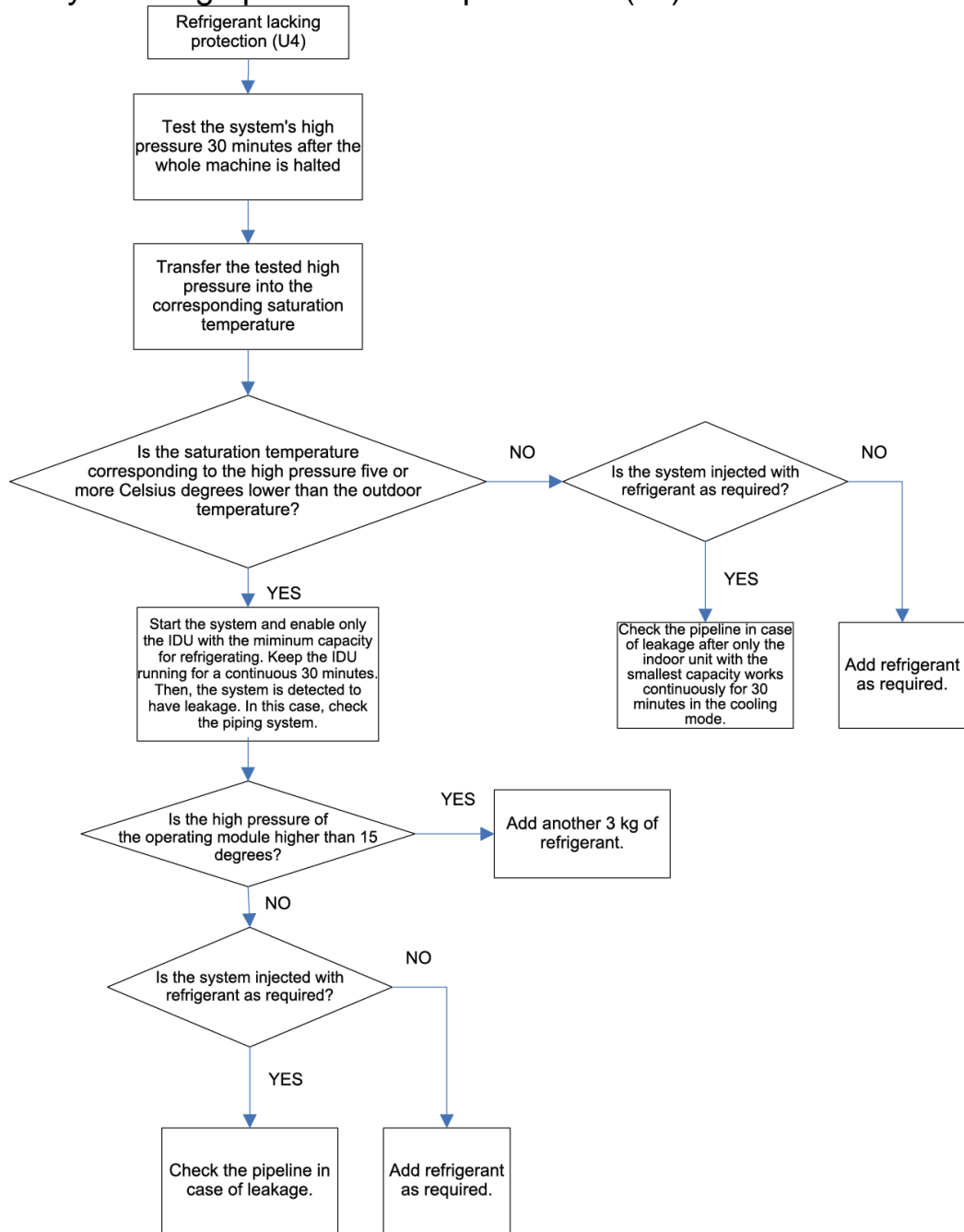

4.2.7. System low pressure ratio protection (J9)

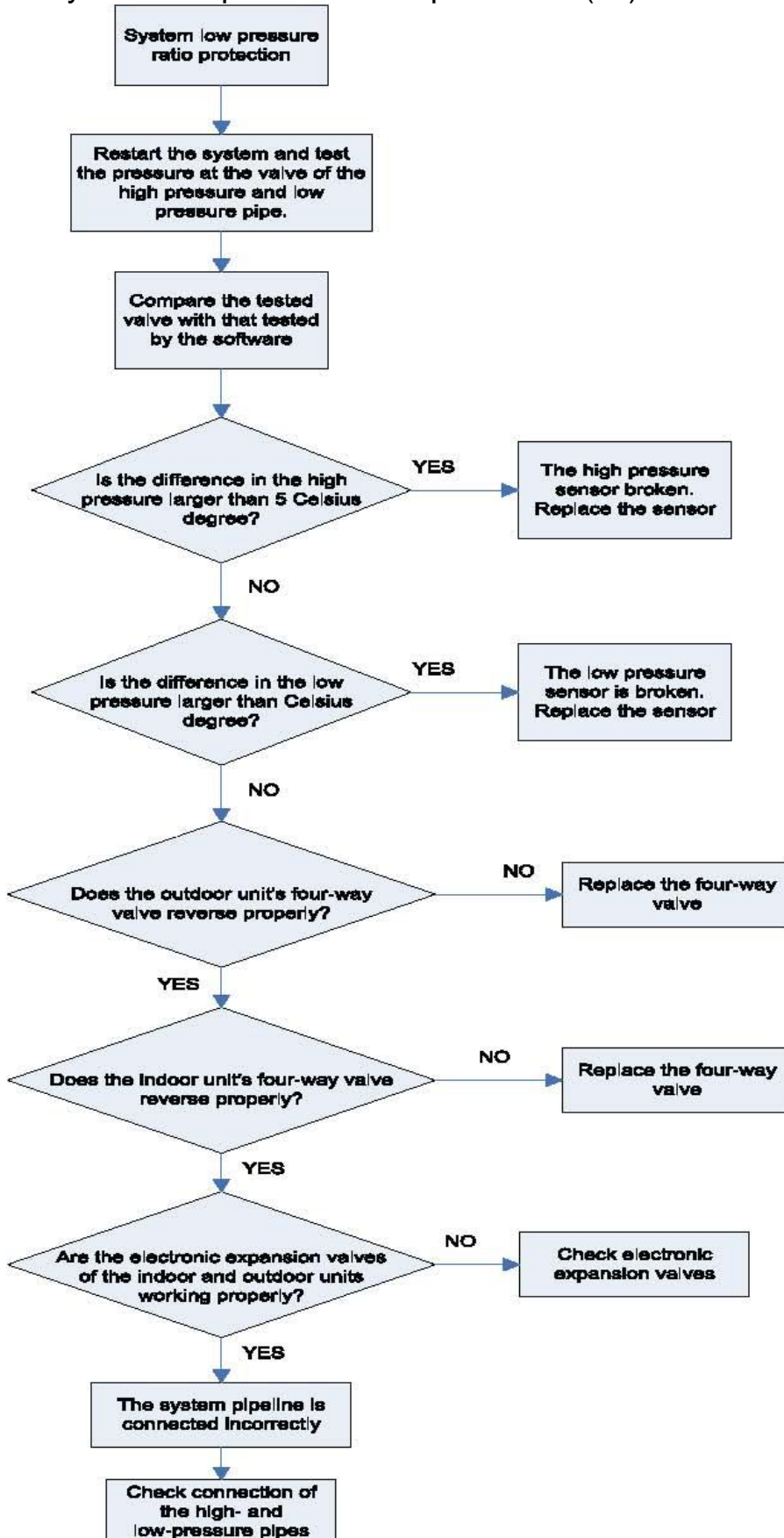

4.2.8. Indoor unit anti-freezing protection (L5)

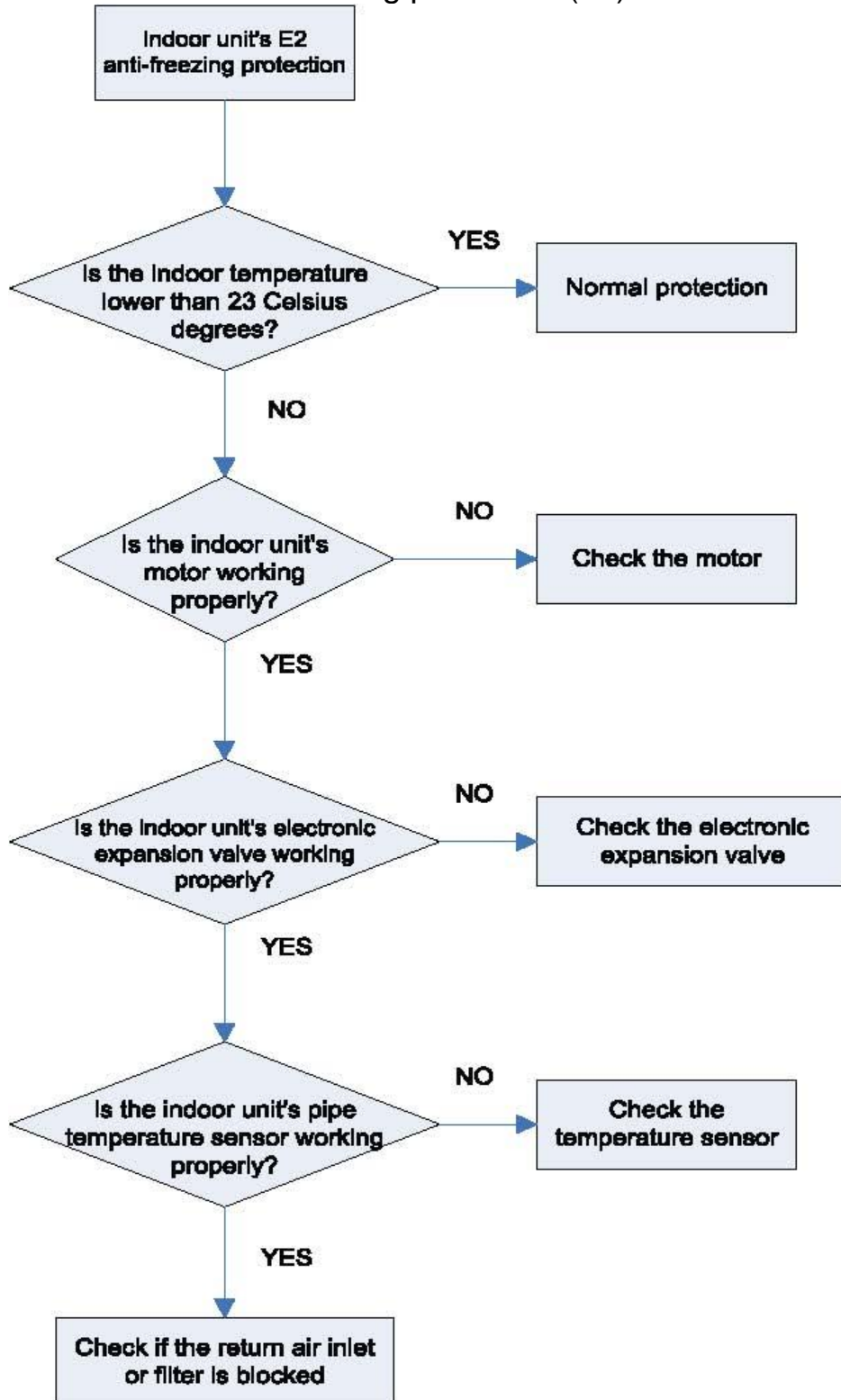

4.2.9. Indoor unit water overflow protection (L3)

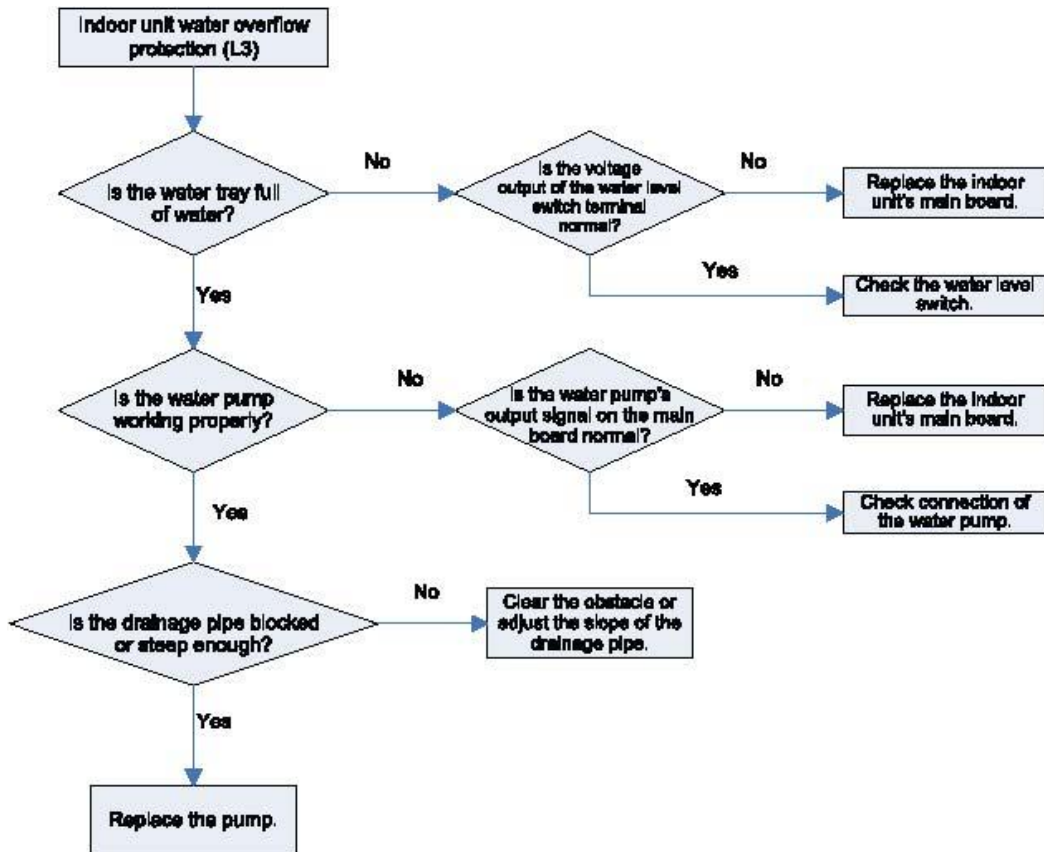

4.2.10. Temperature sensor fault

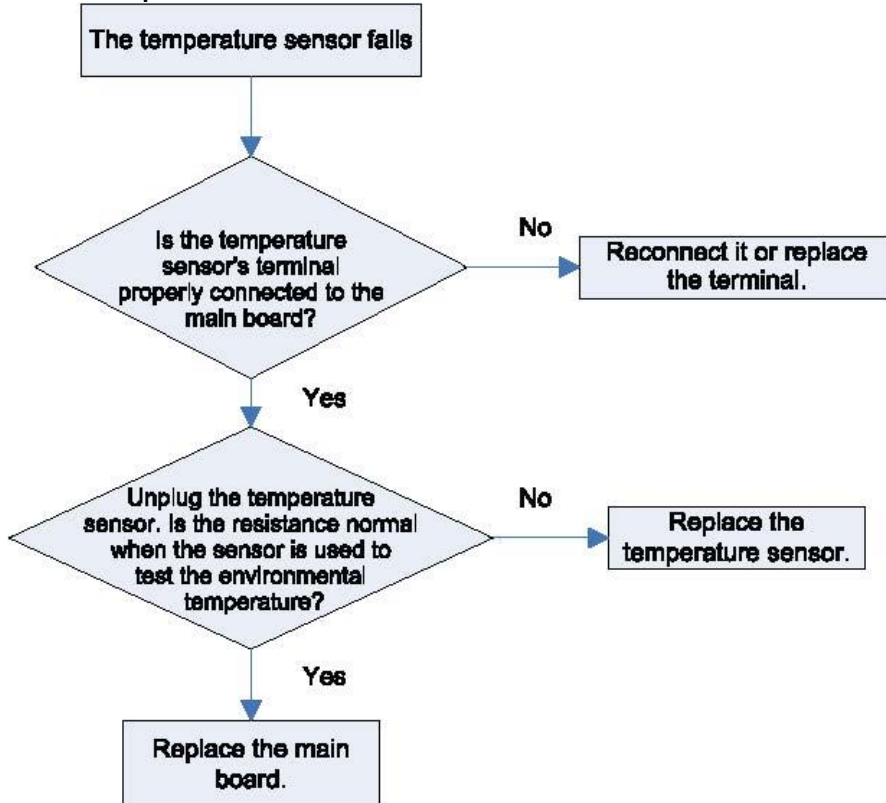

4.2.11. Pressure sensor fault

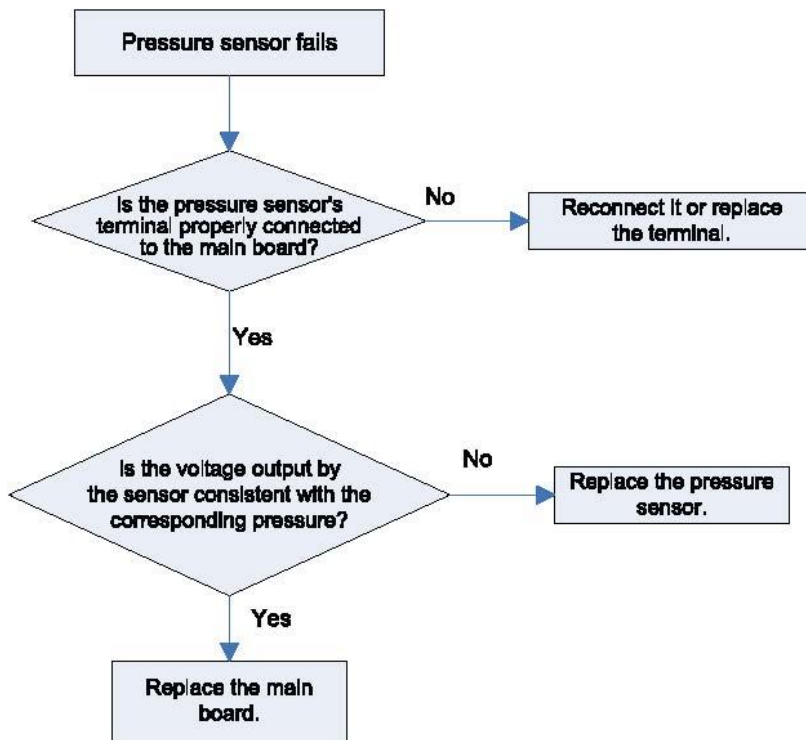

4.2.12. Analysis of drive control system faults

When the unit fails and halts, first check the dual-8 digit nixie tube of main control board and fault table to find out the specific fault. Then check and solve the fault according to the following methods.

- 1) Communication failure between the compressors drive board and control board (outdoor fault C2)

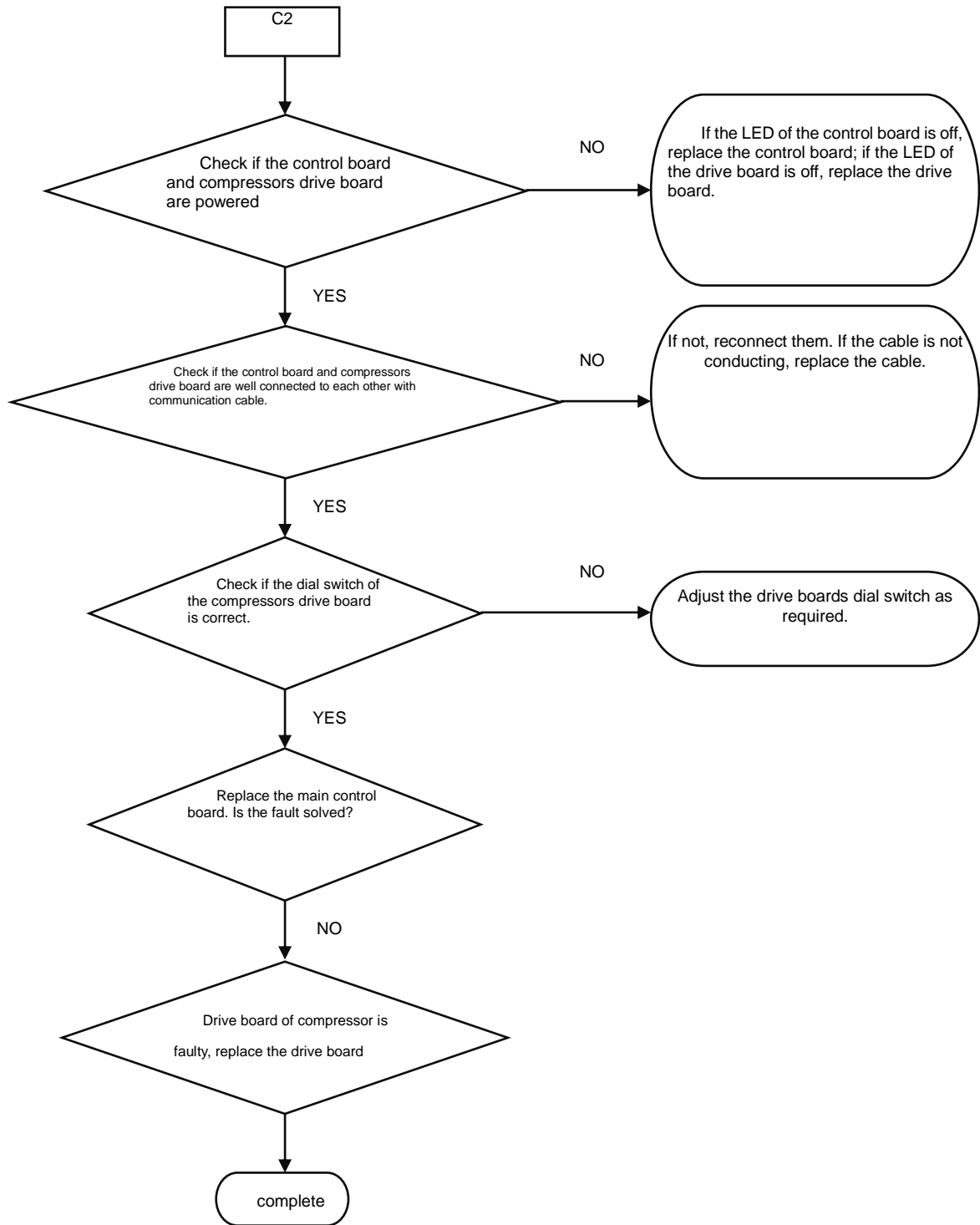

Faults in the IPM temperature sensor of the inverter compressor's drive board (IDU fault code P7), current detection circuit (ODU fault code PC), drive module reset protection (ODU fault P3) and out-of-step protection (ODU fault P9).

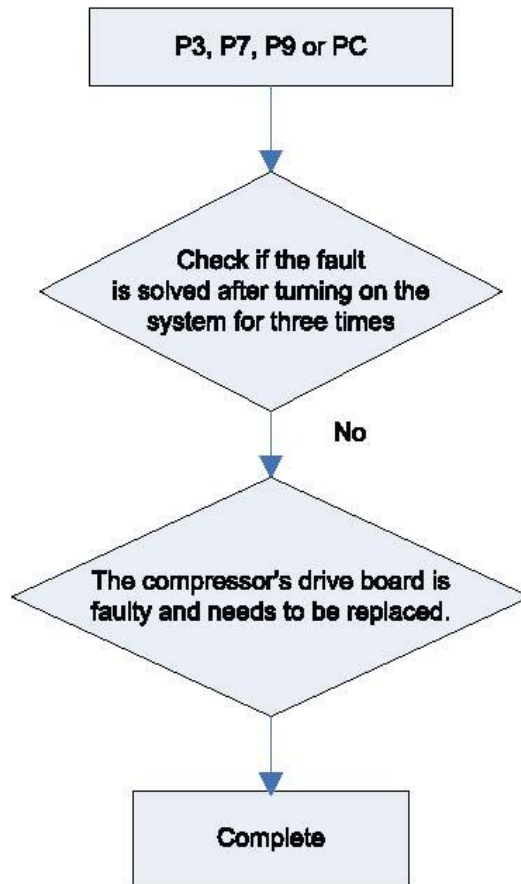

Inverter compressor overcurrent protection (ODU fault code P5) and IPM module protection faults (ODU fault P6)

GMV5 Home DC Inverter Multi VRF Units

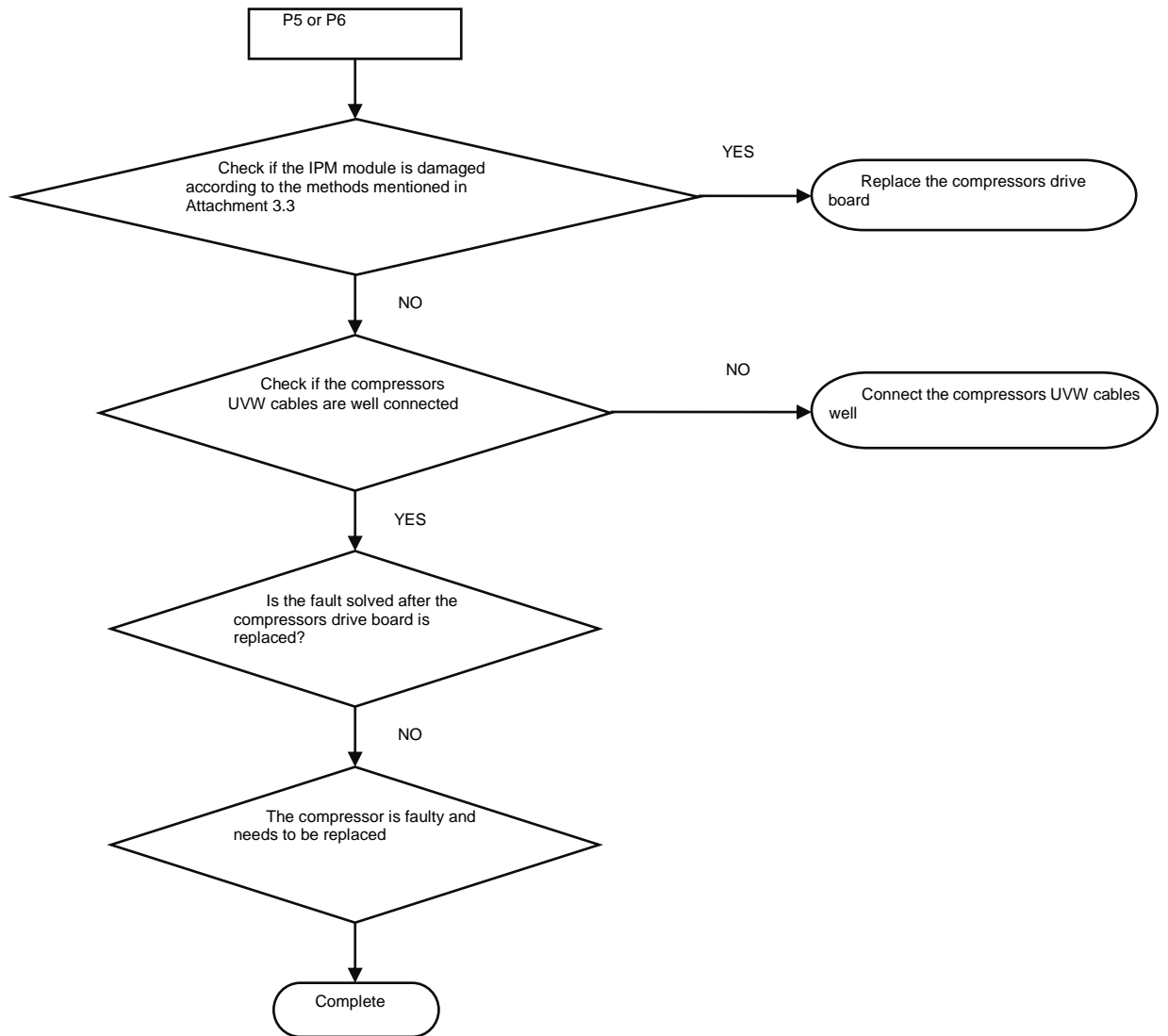

Attachment: How to check whether the IPM module is damaged:

- 7) Preparation: Find a digital multi-meter and switch it to the diode. Remove U, V and W cables of the compressor from the drive board two minutes after the system is powered off. Make sure that it is tested at least two minutes after the system is powered off.
- 8) Method: Use the black probe of the multi-meter to touch the place marked by P in the follow picture and the red probe to touch places marked by U, V and W respectively and record readings of the multi-meter. Use the red probe to touch the place marked by N and black probe to touch places marked by U, V and W respectively and record readings of the multi-meter.
- 9) Analysis: If the reading ranges between 0.3 V and 0.7 V in the above-mentioned six scenarios, the IPM module is normal. If the reading is 0 in one or multiple scenarios, the IPM module is damaged.



Inverter compressor drive board IPM module over-temperature fault (ODU fault code P8)

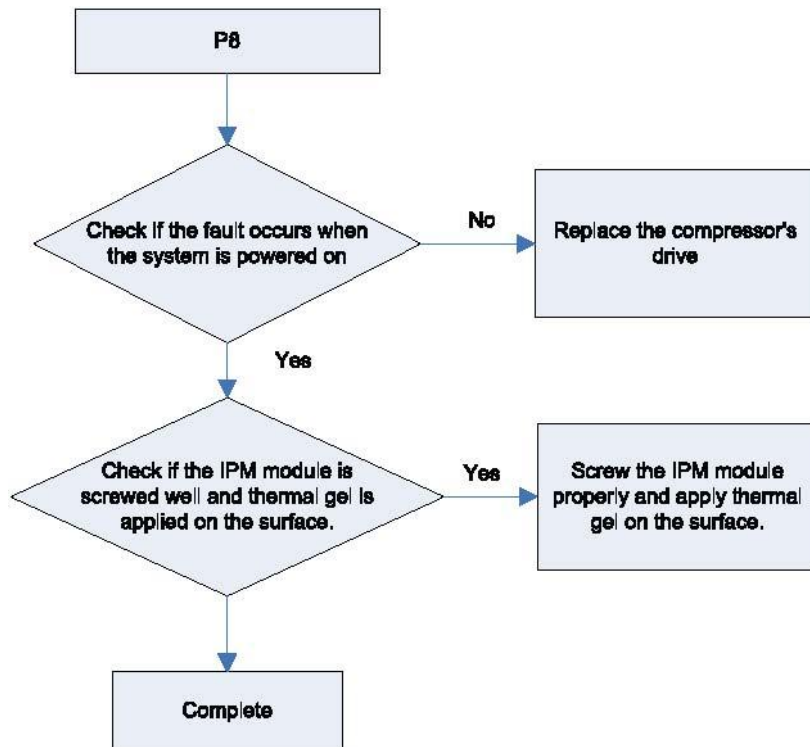

Recharging circuit faulty of the inverter compressor drive board (ODU fault code PF)

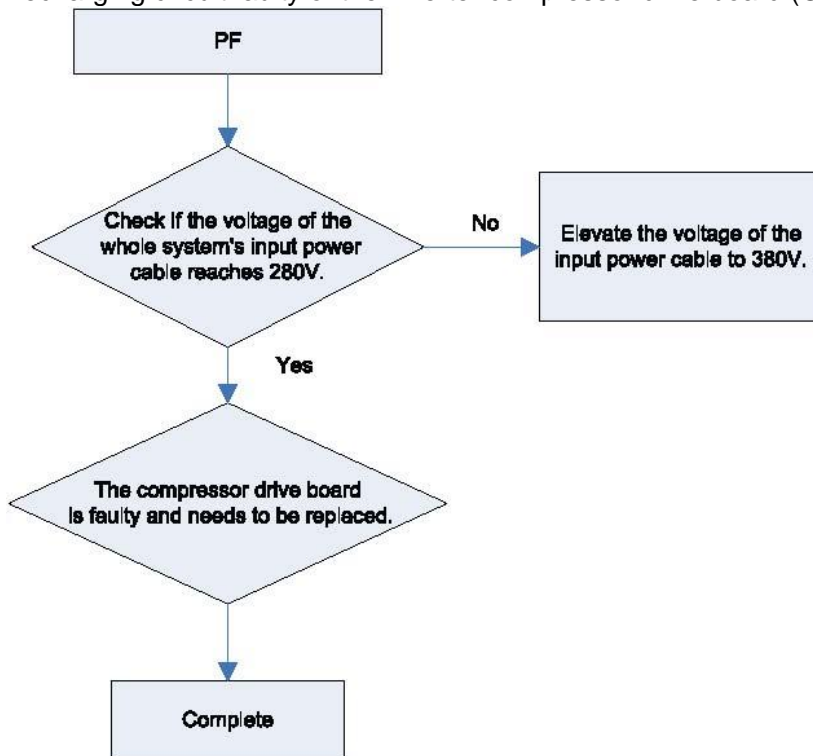

High voltage protection for the DC bus of the inverter compressors drive board (ODU fault code PH)

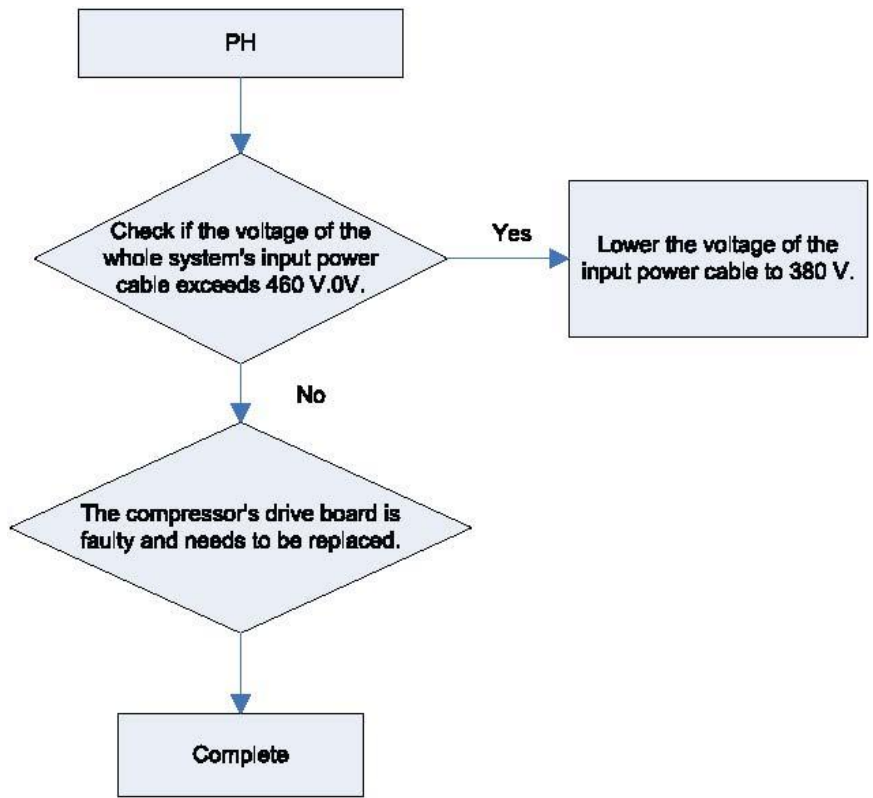

Low voltage protection for the DC bus of the inverter compressors drive board (ODU fault PL)

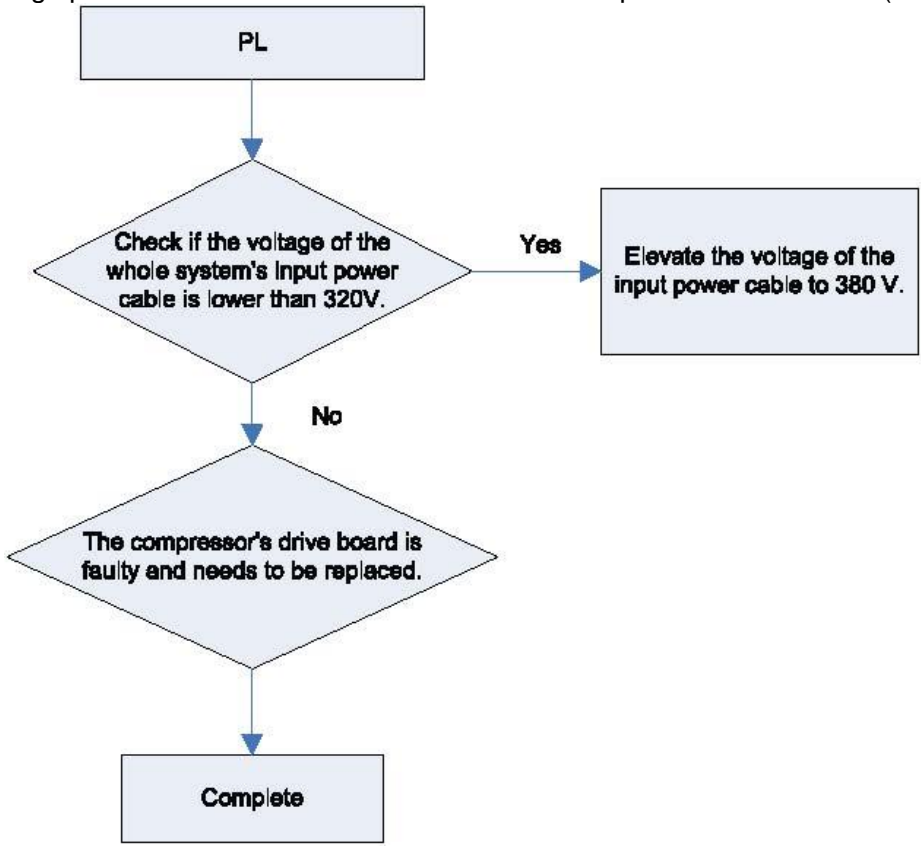

Inverter compressor startup failure (ODU fault code PJ)

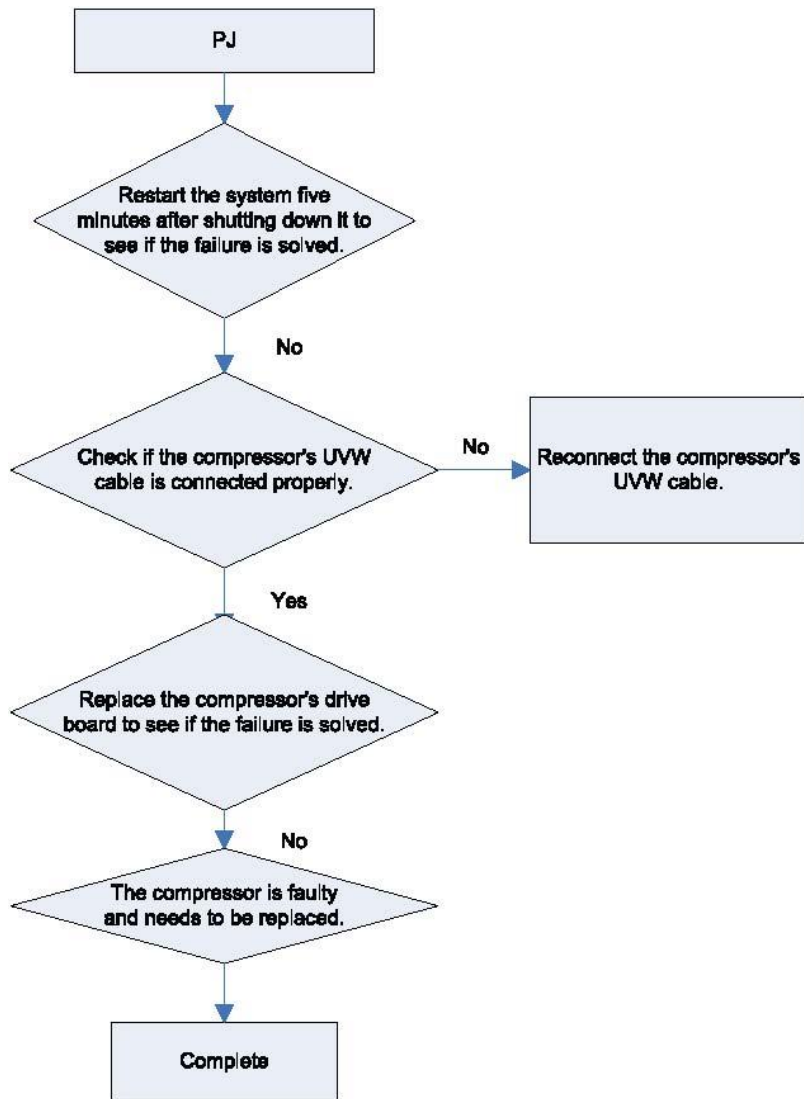

Analysis of faults in the inverter fan drives control system

- (1) Communication failure between the fans drive board and control board (outdoor fault C3)

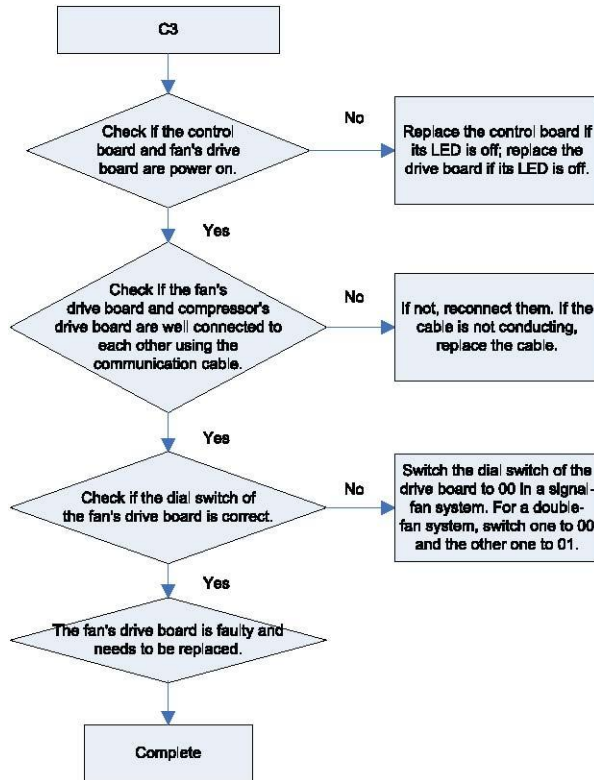

- 4) Faults in the IPM temperature sensor of fans drive board (ODU fault code H7), current detection circuit (ODU fault code HC), and out-of-step protection (ODU fault H9).

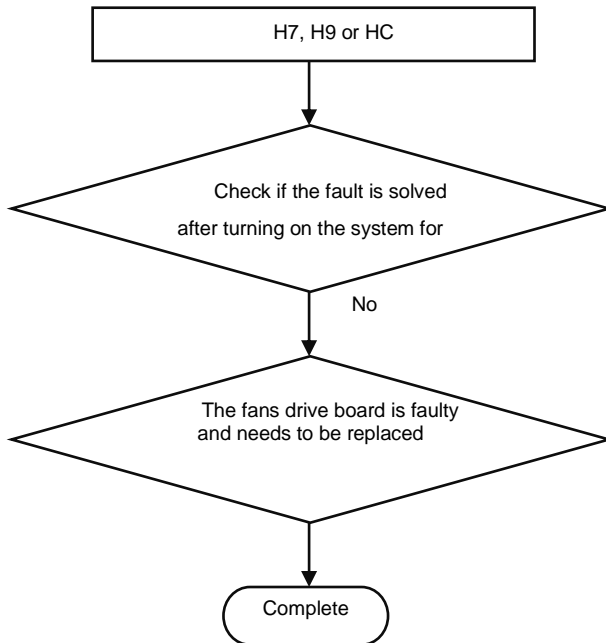

5) Inverter fan overcurrent protection (ODU fault code H5), and IPM module protection fault (ODU fault code H6)

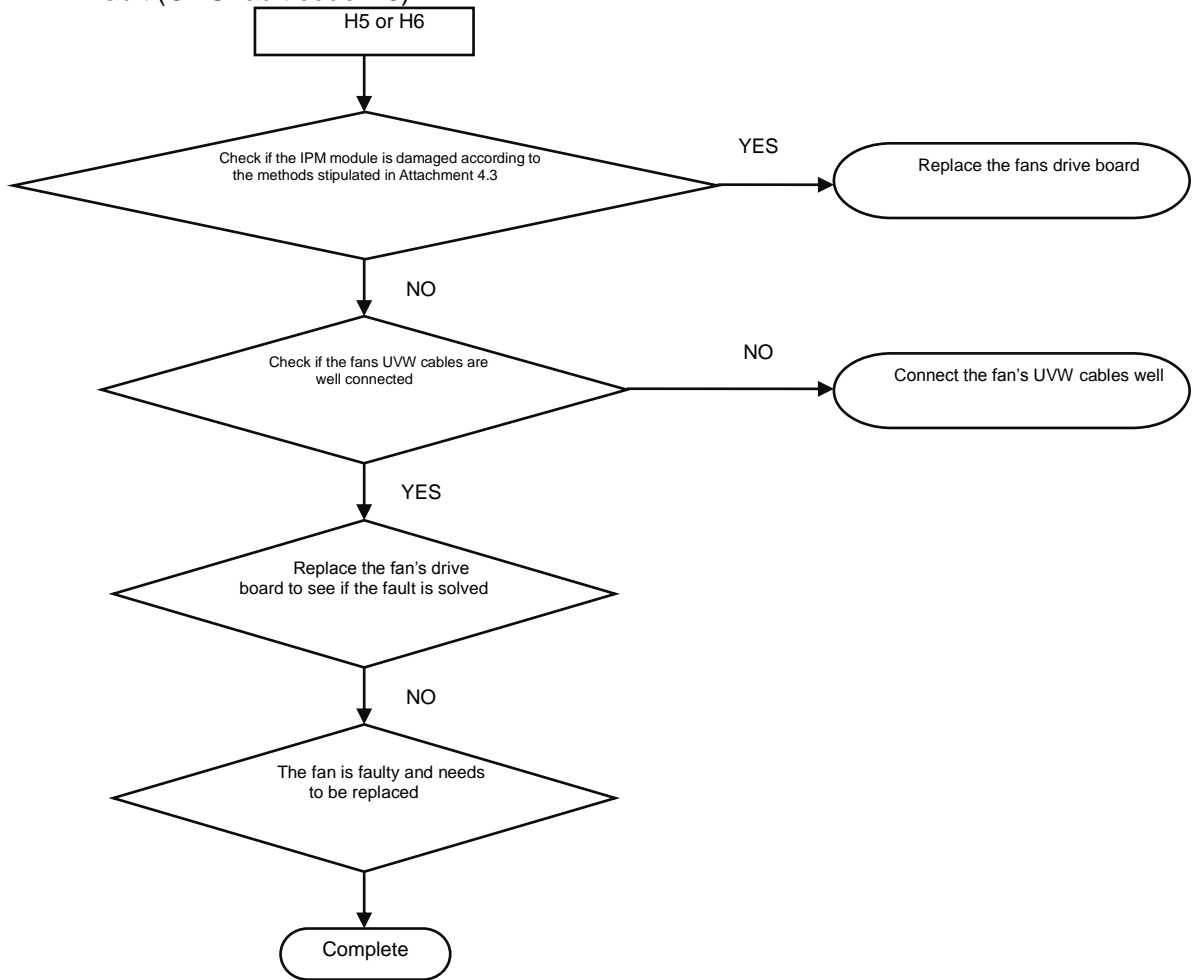

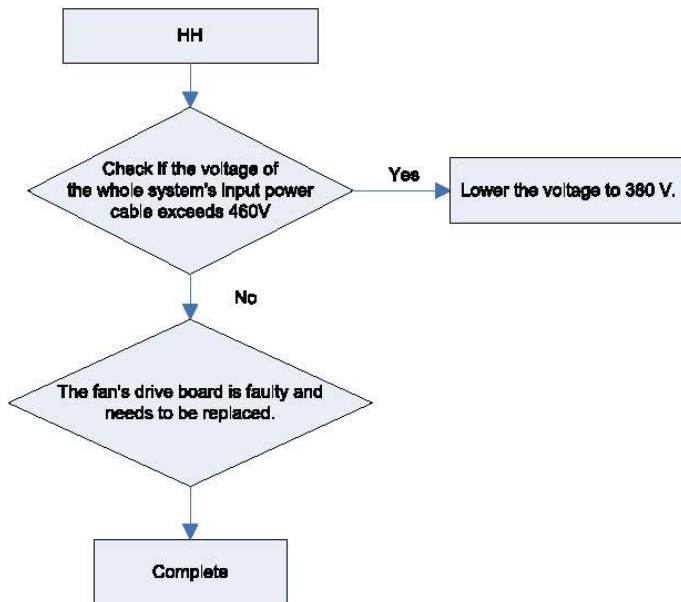

Low voltage protection for the DC bus of the inverter fan's drive board (ODU fault code HL)

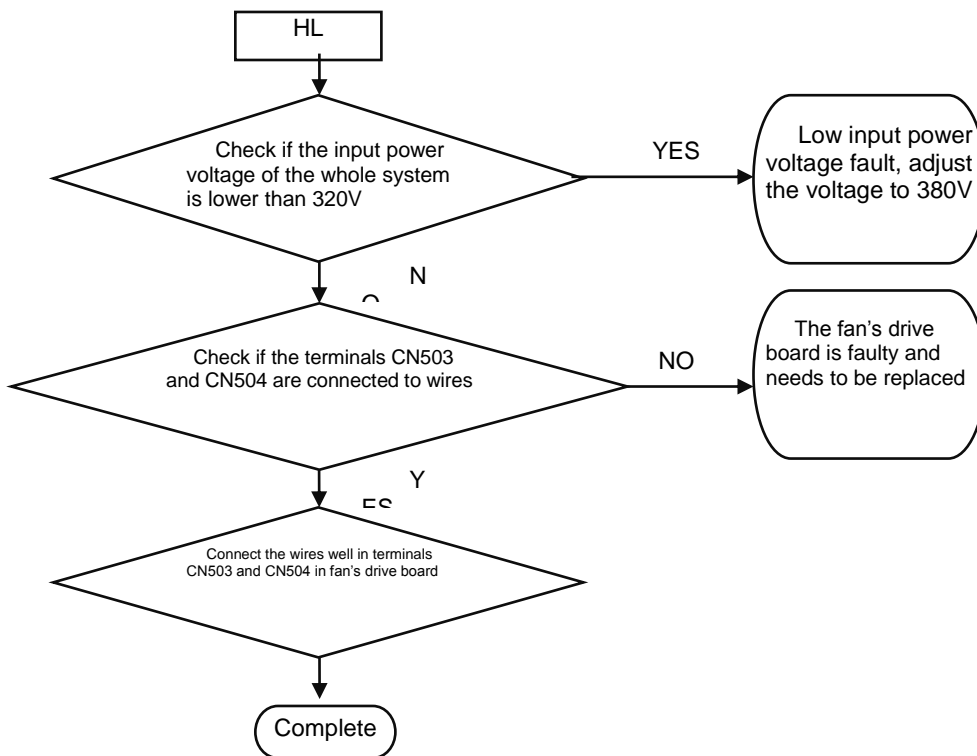

Inverter fan startup failure (ODU fault code HJ)

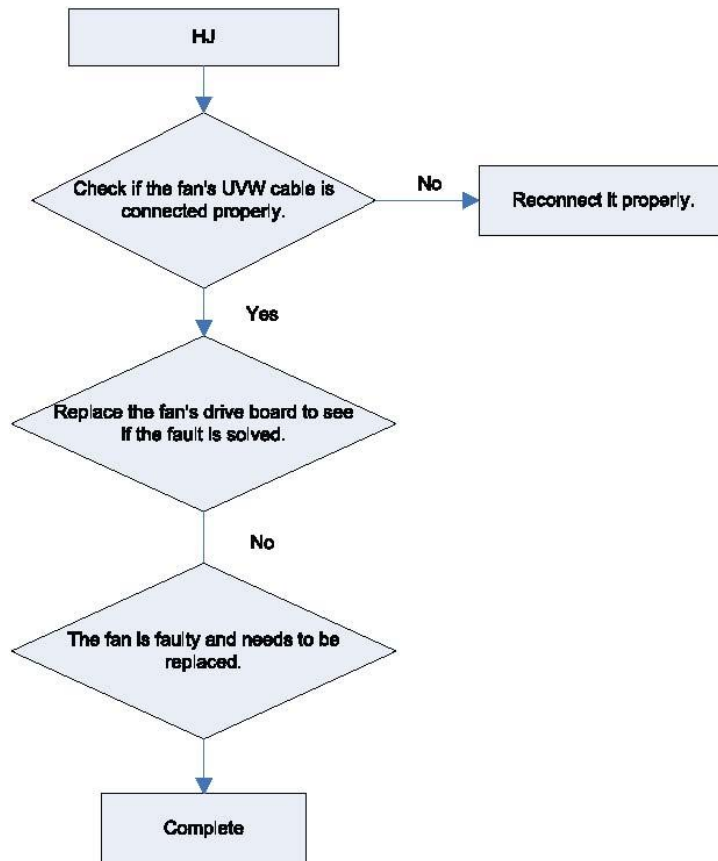

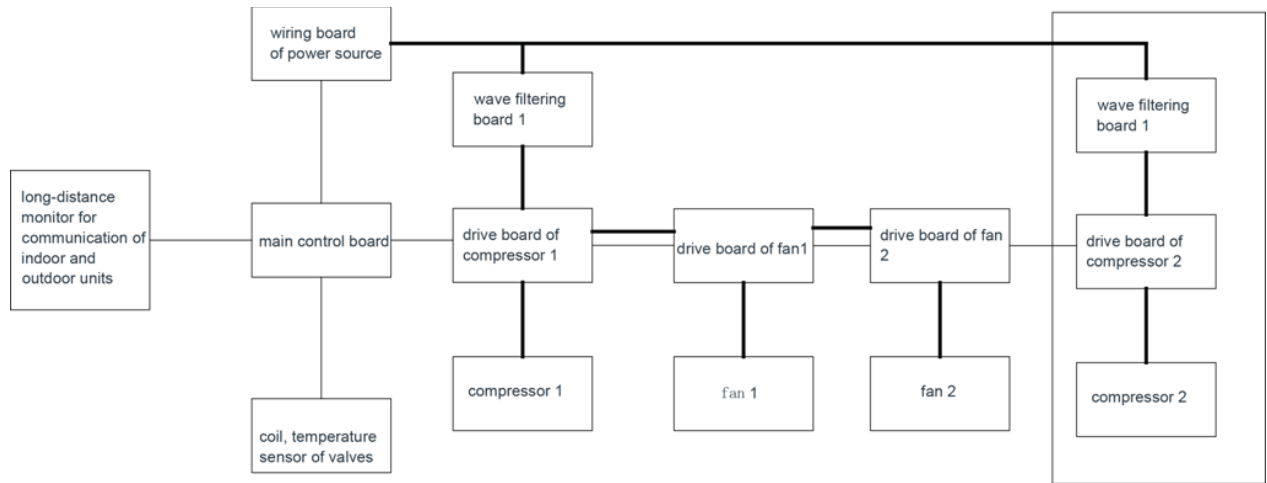

5. Power Distribution

5.1 Power distribution method



5.2 Introduction on key electric parts

Name	Picture	Introduction of functions
Wave filtering board		It's mainly for filtering interference in the power source, protecting anti-interference performance of unit in inferior quality of power source; second, it can restrain unit's interference to power source to prevent the operation of unit from impacting other home appliances' operation.
Air switch		For connection and disconnection of main circuit, can protect the unit in overcurrent and short circuit situations.
IPM module		Inside the IPM module, it has integrated 3 sets of complementary IGBT tubes, their connection and disconnection can be controlled by PWM wave, which can apply the voltage of DC bus to different winding of stator in different period of time, and can bring current in the stator and at the same time induce magnetic field in rotor coil, so as to drive the operation of rotor and compressor.

GMV5 Home DC Inverter Multi VRF Units

<p>PFC module</p>		<p>Inside the PFC module, it has integrated four diodes and 2 MOS tubes, which can convert inputted AC power source into outputted DC power source, at the same time control connection and disconnection of MOS tube via PWM wave, and resort to inductance to increase the voltage.</p>
-------------------	---	---

5.3 Circuit Diagram

5.3.1 Circuit diagram of outdoor unit

Circuit diagram of GMV-S224W/A-X, GMV-S280W/A-X

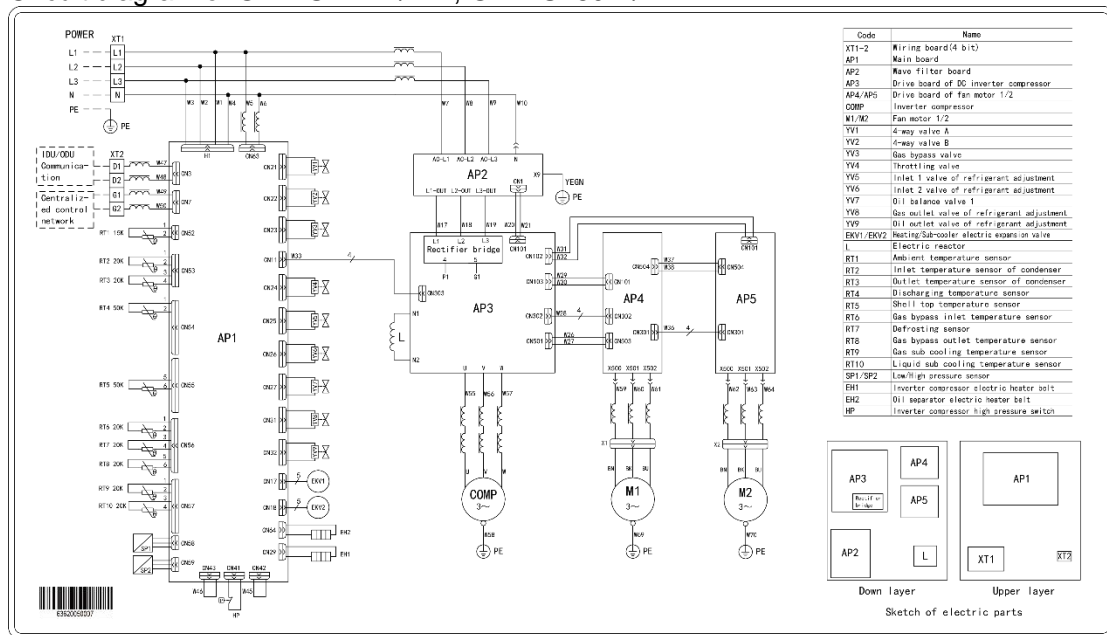

Notes: The above circuit diagram is only for reference, for specific contents please subject to circuit diagram stuck in electric box of unit.

5.3.2 Circuit diagram of hydro box

Electric schematic diagram of NRQD16G/A-S

GMV5 Home DC Inverter Multi VRF Units

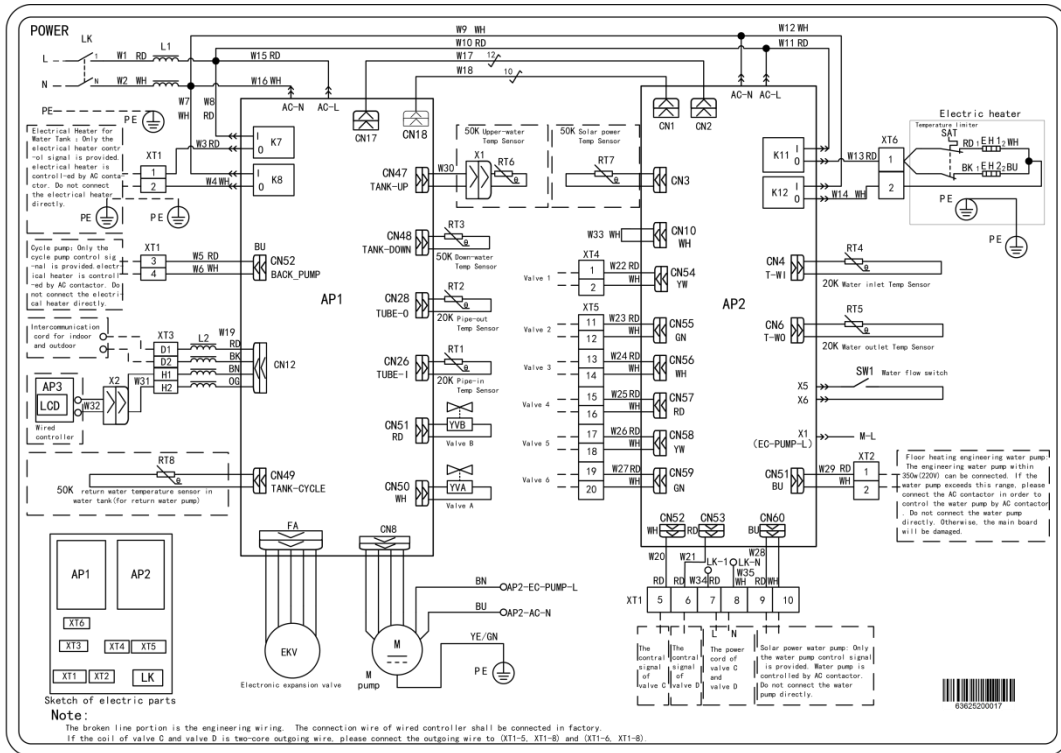



Notes: The above circuit diagram is only for reference, for specific contents please subject to circuit diagram stuck in electric box of unit.



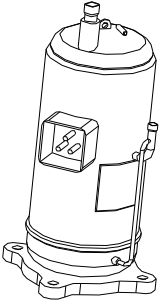

6. Assembly and Disassembly of parts

6.1 Introduction on key parts

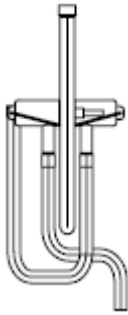

The picture column is shown with 3D projection drawing

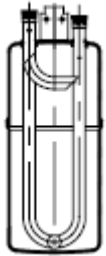
Picture	Name	Fuction
	Compressor	Through compression of compressor, the volume of low-pressure cooling work medium is reduced, the pressure and temperature are increased, the high-pressure and high-temperature cooling work medium is the motive power source of the whole system.
	Electronic expansion valve	It's a throttling device, convert high-pressure liquid refrigerant into low-pressure steam

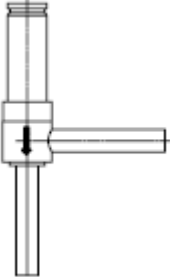
GMV5 Home DC Inverter Multi VRF Units

	<p>Four-way valve</p>	<p>Alter flow direction of refrigerant, achieve conversion between cooling and heating</p>
	<p>Oil separator</p>	<p>It is located between air outlet of compressor and inlet of condenser, for separating lubricant brought by high-temperature, high-pressure and high-speed refrigerant gas discharged from compressor.</p>
	<p>Gas-liquid separator</p>	<p>It is located between outlet of evaporator and air inlet of compressor, for separating low-temperature and low-pressure refrigerant.</p>
	<p>One-way valve</p>	<p>Restrict flow direction of refrigerant, prevent it from flowing conversely</p>
	<p>Magnetic valve</p>	<p>Control connection and disconnection of strong current, the valve is opened after being energized, and is closed after being de-energized.</p>

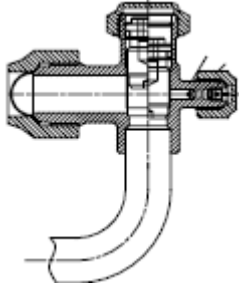
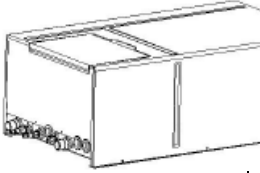
GMV5 Home DC Inverter Multi VRF Units

	<p>Cut-off valve</p>	<p>For connecting indoor and outdoor units, and for maintenance and installation.</p>
	<p>Hydro box</p>	<p>The part for conducting heat exchange between refrigerant and water</p>
	<p>Thermal insulation water tank</p>	<p>For storing hot water</p>

6.2 Assembly and disassembly of key parts

Assembly and disassembly of outdoor unit

Assembly and disassembly of compressor

Precondition: No refrigerant exists in the pipeline system and the power supply has been disconnected.

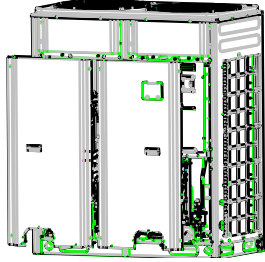
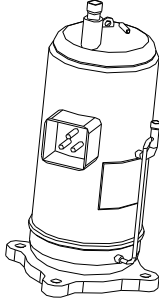
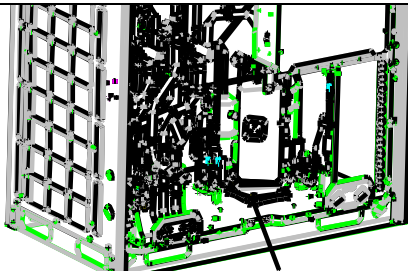
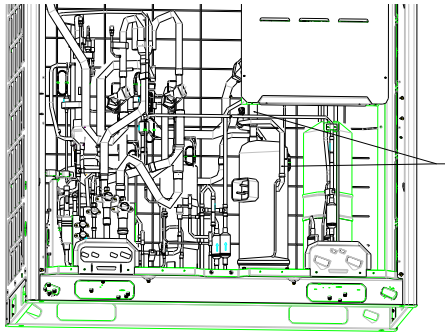
Step	Diagram	Operation Instruction
<p>1. Remove the front panels.</p>		<ul style="list-style-type: none"> ● Use a screwdriver to unscrew the upper and lower front panels. ● Lift the front panels to take it out, and then take it out to set it aside. <p>Note: There are four fasteners in left and right front panels to connect to the left and right side panels.</p>
<p>2. Disassemble the power cord, electric heating belt, top temperature sensor and discharge air temperature sensor of compressor.</p>		<ul style="list-style-type: none"> ● Remove the sound-proof sponge from the compressor first; ● Use a screwdriver to unscrew the power cord; ● Remove the power cord; ● Remove the electric heating belt, top temperature sensor and discharge air temperature sensor. <p>Note: Before removing the power cord, mark the color of the cord and corresponding wiring terminals.</p>
<p>3. Screw off the nuts of compressor</p>		<ul style="list-style-type: none"> ● Use a wrench to unscrew the four nuts of compressor.
<p>4. Remove the suction and discharge pipes.</p>		<ul style="list-style-type: none"> ● Heat up the suction and discharge pipes with acetylene welding and then remove the pipes; ● During the welding, charge nitrogen into the pipes. The pressure should be controlled within $0.5 \pm 0.1 \text{ kgf/cm}^2$ (relative pressure). ● Prevent nearby materials from being burnt during welding.

GMV5 Home DC Inverter Multi VRF Units

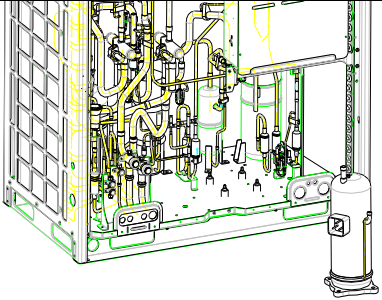
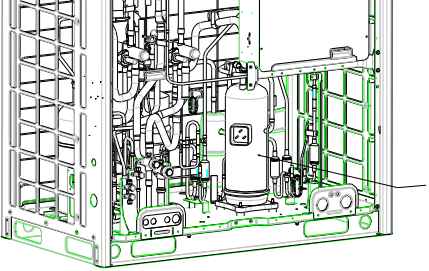
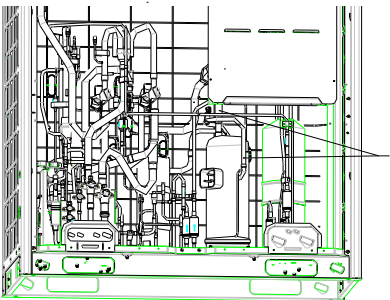
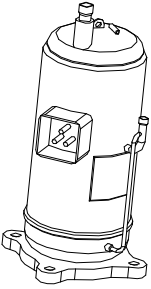
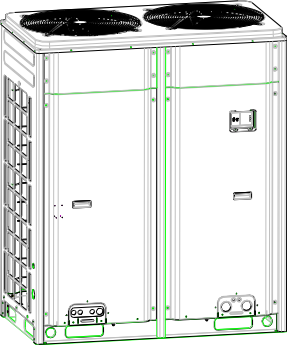
<p>5. Take out the compressor.</p>		<ul style="list-style-type: none"> ● Remove the compressor from the chassis.
<p>6. Install a new compressor on the chassis.</p>		<ul style="list-style-type: none"> ● Put the compressor in a proper position; ● Use a wrench to screw the nuts on the compressor ● The compressor should not be installed upside down.
<p>7. Connect the suction and discharge pipes of the compressor to the pipeline system.</p>		<ul style="list-style-type: none"> ● Heat up the suction and discharge pipes by acetylene welding and then pull out the pipes. ● During welding, charge nitrogen into the pipes. The pressure should be controlled within 0.5 ± 0.1 kgf/cm₂ (relative pressure). ● Note to prevent nearby materials from being burnt during welding.
<p>8. Connect power cord to the compressor, and install electric heating belt, top temperature sensor, and discharge air temperature sensor.</p>		<ul style="list-style-type: none"> ● Put the power cord in a proper position; ● Use a screwdriver to screw the power cord; ● Install the electric heating belt, top temperature sensor, and discharge air temperature sensor. ● Put the sound-proof sponge back to position.
<p>9. Check and then install the front panels.</p>		<ul style="list-style-type: none"> ● Check the parts and connecting wires; ● If no problem is found, hook the front panels and tighten the screws.

GMV5 Home DC Inverter Multi VRF Units

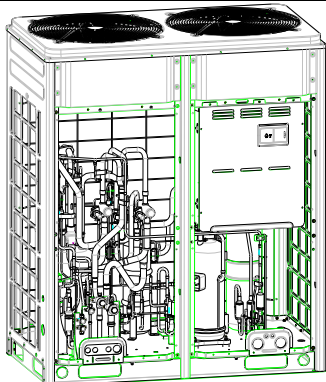
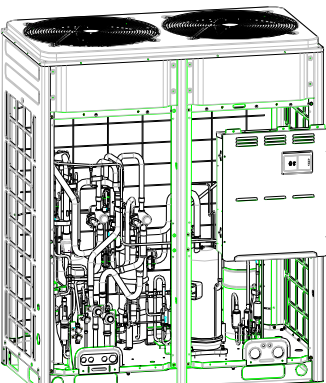
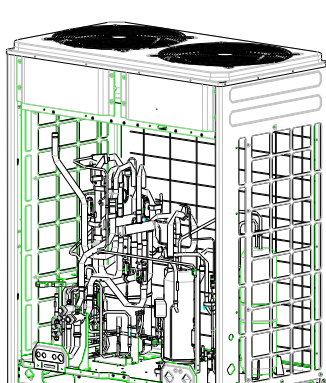
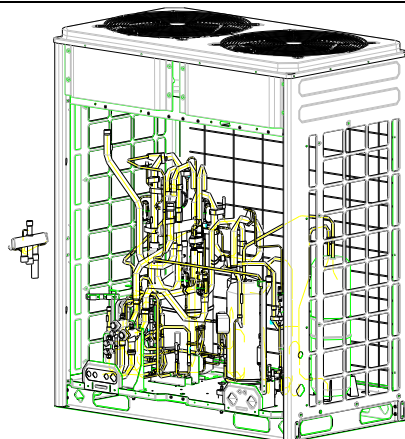
Assembly and disassembly of four-way valve		
Precondition: No refrigerant exists in the pipeline system and the power supply has been disconnected.		
Step	Diagram	Operation Instruction
<p>1. Loosen the hooks at the bottom of the electric box and the screws.</p>		<ul style="list-style-type: none"> ● Remove the left and right front panels and set them aside; ● Loosen the hooks at the bottom of the electric box; ● Use a screwdriver to unscrew the electric box.
<p>2. Remove the electric box.</p>		<ul style="list-style-type: none"> ● Disconnect internal and external connecting wires of the electric box; ● Protect the internal parts during the disassembly.
<p>3. Disassemble the four-way valve.</p>		<p>Use a screwdriver to unscrew accessories of the four-way valve. Remove the accessories;</p> <ul style="list-style-type: none"> ● Heat up the nozzles of connecting pipes of the four-way valve with acetylene welding and then remove the pipes; ● Record the direction of the valve and position of the pipe joints. <p>Note: Prevent nearby parts from being burnt during welding.</p>
<p>4. Remove the four-way valve</p>		<ul style="list-style-type: none"> ● Remove the four-way valve from the pipeline.

GMV5 Home DC Inverter Multi VRF Units

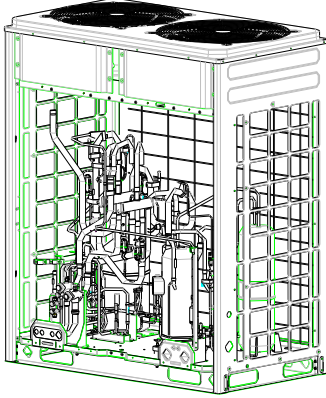
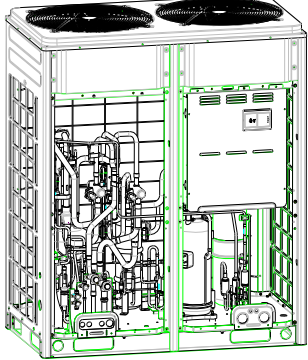
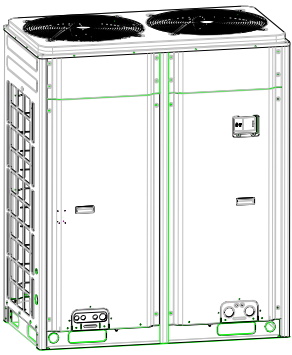
<p>5. Install a new four-way valve.</p>		<ul style="list-style-type: none"> ●Put the valve in a proper position for installation; ●Weld the valve with the pipeline. ●Before welding, cover the valve with wet cloth to prevent internal slide from being burnt and prevent water from flowing in the pipeline. ●During welding, charge nitrogen into the pipes. The pressure should be controlled within 0.5 ± 0.1 kgf/cm₂ (relative pressure).
<p>6. Fix and wire the electric box.</p>		<ul style="list-style-type: none"> ●Put the electric box back to original position and screw it up. ●Connect all the wires.
<p>7. Check and install the front panels.</p>		<ul style="list-style-type: none"> ●Check the parts and connecting wires; ●If no problem is found, hook the front panels and tighten the screws.

Assembly and disassembly of electric expansion valve

Precondition: No refrigerant exists in the pipeline system and the power supply has been disconnected.

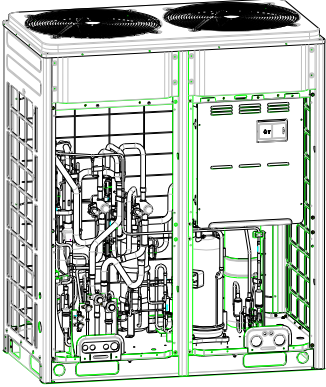
Step	Diagram	Operation Instruction
<p>1. Loosen the hooks at the bottom of the electric box and the screws.</p>		<ul style="list-style-type: none"> ●Remove the left and right panels and set them aside; ●Loosen the hooks at the bottom of the electric box; ●Use a screwdriver to unscrew the electric box.

GMV5 Home DC Inverter Multi VRF Units

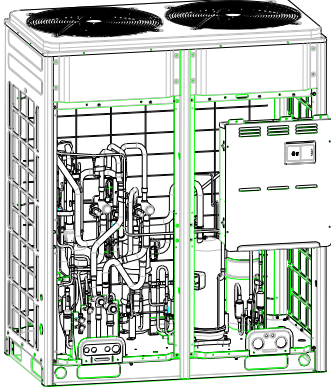
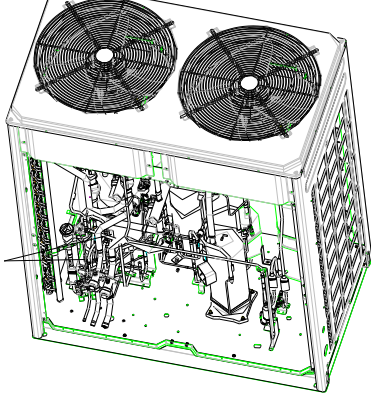
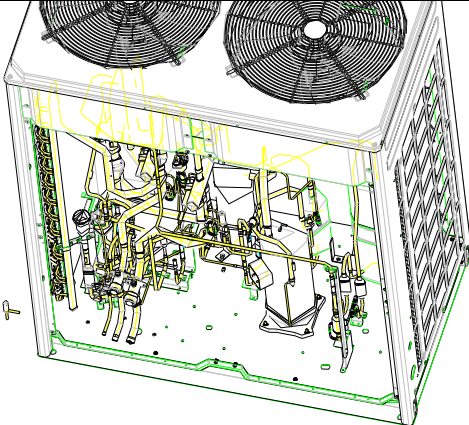
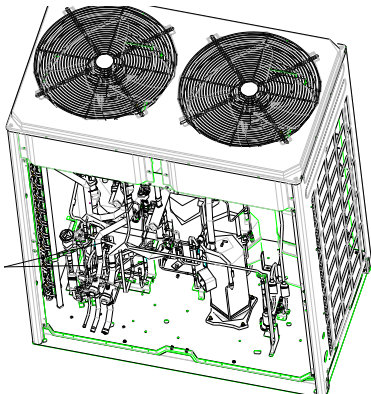
<p>2. Remove the electric box.</p>		<ul style="list-style-type: none"> ● Disconnect internal and external connecting wires of the electric box. ● Protect the internal parts during the disassembly.
<p>3. Disassemble the electric expansion valve.</p>		<ul style="list-style-type: none"> ● Remove the coil from the electric expansion valve; ● Heat up the connecting pipes of the electric expansion valve with welding and then remove the pipes. <p>Note: Prevent nearby parts from being burnt during welding.</p>
<p>4. Remove the electric expansion valve.</p>		<ul style="list-style-type: none"> ● Remove the electric expansion valve.
<p>5. Install a new electric expansion valve.</p>		<ul style="list-style-type: none"> ● Weld the connecting pipes of the electric expansion valve. ● Before welding, cover the valve with wet cloth. ● During welding, charge nitrogen into the pipes. The pressure should be controlled within 0.5 ± 0.1 kgf/cm₂ (relative pressure). <p>Note: Prevent nearby parts from being burnt during welding.</p> <ul style="list-style-type: none"> ● Install the coil on the electric expansion valve.

GMV5 Home DC Inverter Multi VRF Units

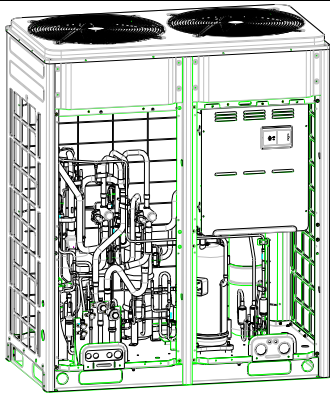
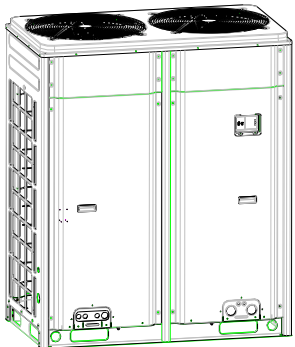
<p>6. Fix and wire the electric box.</p>		<ul style="list-style-type: none"> ● Put the electric box back to original position and screw it up. ● Connect all wires.
<p>7. Check and install the front panels.</p>		<ul style="list-style-type: none"> ● Check the parts and connecting wires; ● If no problem is found, hook the front panels and tighten the screws.

Assembly and disassembly of oil separator

Precondition: No refrigerant exists in the pipeline system and the power supply has been disconnected.

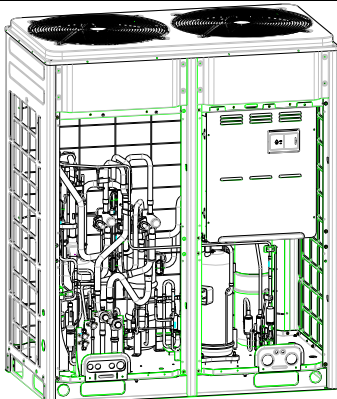
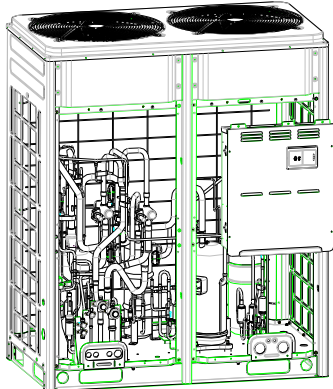
Step	Diagram	Operation Instruction
<p>1. Loosen the hooks at the bottom of the electric box and the screws.</p>		<ul style="list-style-type: none"> ● Remove the left and right front panels and set them aside; ● Loosen the hooks at the bottom of the electric box. ● Use a screwdriver to unscrew the electric box.
<p>2. Remove the electric box.</p>		<ul style="list-style-type: none"> ● Disconnect internal and external connecting wires of the electric box. ● Protect the internal parts during the disassembly.

GMV5 Home DC Inverter Multi VRF Units

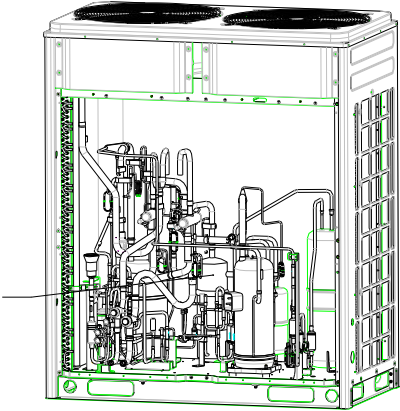
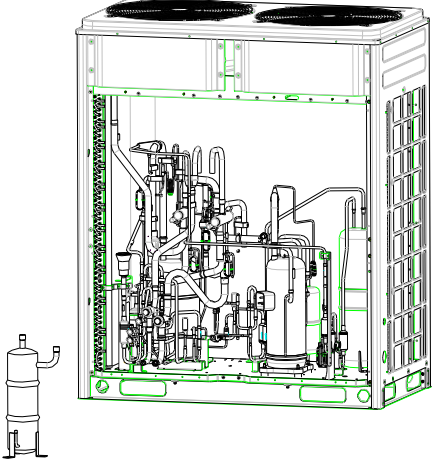
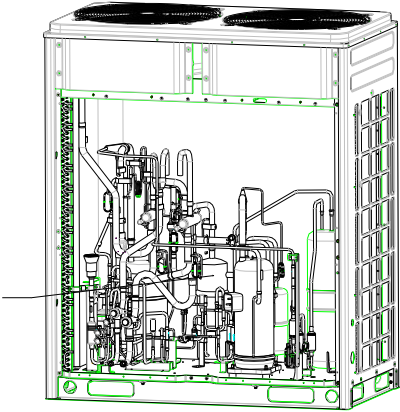
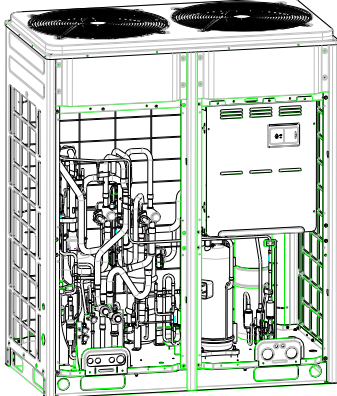
<p>3. Disassemble the oil separator.</p>		<ul style="list-style-type: none"> ● Unscrew the screws for fixing oil separator with screwdriver; ● Loosen the electric heating belt in oil separator; ● Heat up the four connecting points in oil separator and pull out the connecting pipe. <p>Note: Prevent nearby parts from being burnt during welding.</p>
<p>4. Remove the oil separator.</p>		<ul style="list-style-type: none"> ● Remove the oil separator from the chassis.
<p>5. Install a new oil separator</p>		<ul style="list-style-type: none"> ● Weld the four connecting points in oil separator. <p>During welding, the pressure of nitrogen should be within $0.5 \pm 0.1 \text{ kgf/c m}^2$ (relative pressure).</p> <p>Note: Prevent nearby parts from being burnt during welding.</p> <ul style="list-style-type: none"> ● Install the screws of oil separator. ● Install electric heating belt.
<p>6. Fix and wire the electric box.</p>		<ul style="list-style-type: none"> ● 把 Put the electric box to original position and screw it up. ● Connect all the wires.

GMV5 Home DC Inverter Multi VRF Units

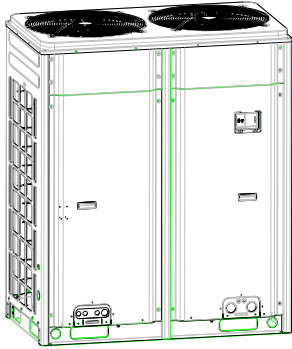
<p>7. Check and install the front panels.</p>		<ul style="list-style-type: none"> ● Check the parts and connecting wires; ● If no problem is found, hook the front panels and tighten the screws.
---	---	--

Assembly and disassembly of gas liquid separator

Precondition: No refrigerant exists in the pipeline system and the power supply has been disconnected.

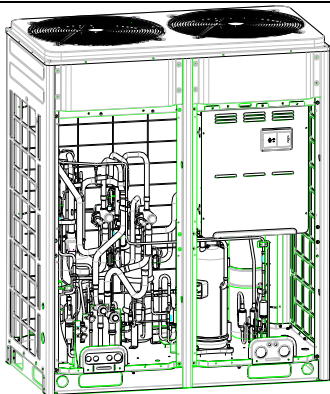
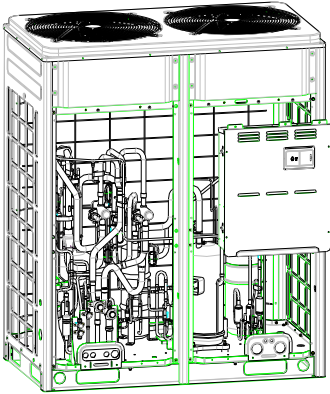
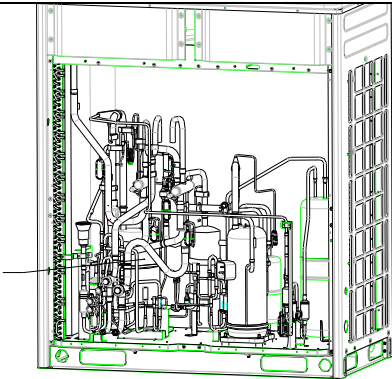
Step	Diagram	Operation Instruction
<p>1. Loosen the hooks at the bottom of the electric box and the screws.</p>		<ul style="list-style-type: none"> ● Remove the left and right front panels and set them aside; ● Loosen the hooks at the bottom of the electric box; ● Use a screwdriver to unscrew the electric box.
<p>2. Remove the electric box.</p>		<ul style="list-style-type: none"> ● Disconnect internal and external connecting wires of the electric box. ● Protect the internal parts during the disassembly.
<p>3. Disassemble the gas liquid separator.</p>		<ul style="list-style-type: none"> ● Heat up the two nozzles of connecting pipes of gas liquid separator with acetylene welding and then remove the pipes. <p>Note: Prevent nearby parts from being burnt during welding.</p>

GMV5 Home DC Inverter Multi VRF Units

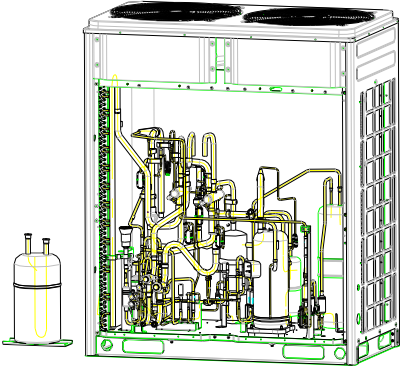
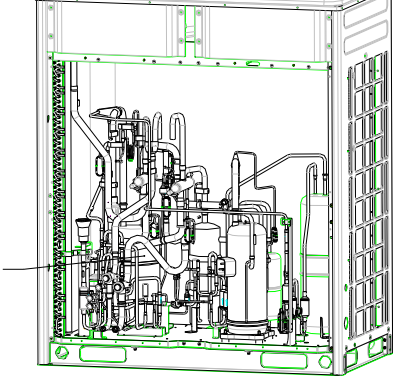
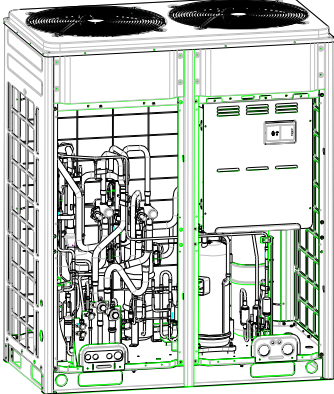
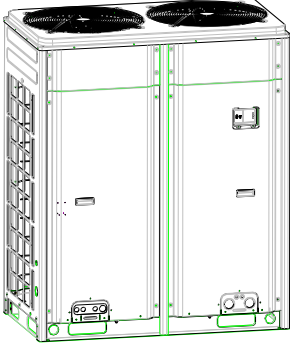
<p>4. Remove the gas liquid separator.</p>		<ul style="list-style-type: none"> ● Unscrew and remove the gas liquid separator.
<p>5. Install a new gas liquid separator</p>		<ul style="list-style-type: none"> ● Put the gas liquid separator according to the position of the suction and discharge pipes and weld the pipes of gas liquid separator. ● During welding, charge nitrogen into the pipes. The pressure should be controlled within 0.5 ± 0.1 kgf/cm₂ (relative pressure). Note: Prevent nearby parts from being burnt during welding. ● Screw the gas liquid separator
<p>6. Fix and wire the electric box.</p>		<ul style="list-style-type: none"> ● Put the electric box back to original position and screw it up. ● Connect all wires.
<p>7. Check and install the front panels.</p>		<ul style="list-style-type: none"> ● Check various parts and connecting lines. ● If no problem is found, hook the front panels and tighten the screws.

GMV5 Home DC Inverter Multi VRF Units

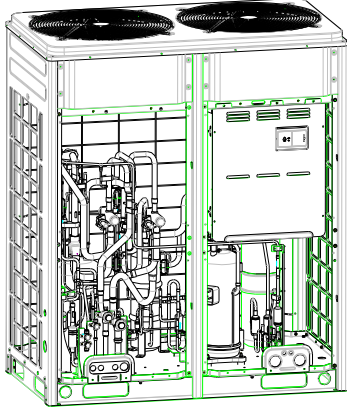
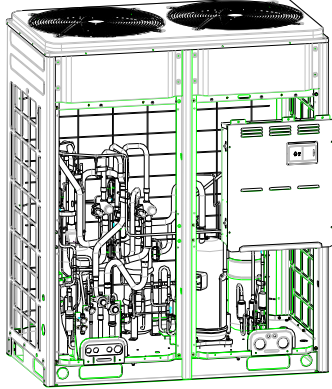
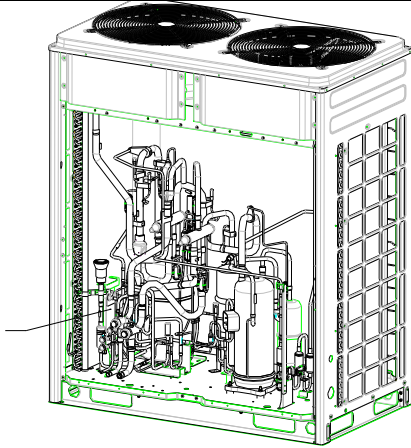
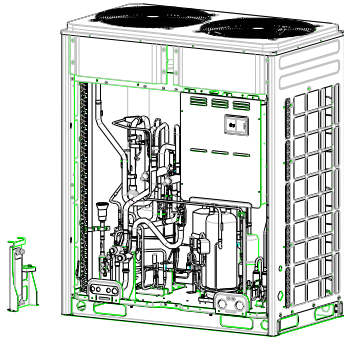
Assembly and disassembly of plate type heat exchanger		
Precondition: No refrigerant exists in the pipeline system and the power supply has been disconnected.		
Step	Diagram	Operation Instruction
<p>1. Loosen the hooks at the bottom of the electric box and the screws.</p>		<ul style="list-style-type: none"> ● Remove the left and right front panels and set them aside; ● Loosen the hooks at the bottom of the electric box. ● Use a screwdriver to unscrew the electric box.
<p>2. Remove the electric box.</p>		<ul style="list-style-type: none"> ● Disconnect internal and external connecting wires of the electric box. ● Use a screwdriver to unscrew the electric box.
<p>3. Disassemble the heat exchanging board.</p>		<ul style="list-style-type: none"> ● Heat up the nozzles of connecting pipes of the plate type heat exchanger with acetylene welding and then remove the pipes. <p>Note: Prevent nearby parts from being burnt during welding. The joints of the plate type heat exchanger must be welded with copper plated steel. Ensure the welding quality.</p>
<p>4. Remove the plate type heat exchanger.</p>		<ul style="list-style-type: none"> ● Unscrew the support of the plate type heat exchanger, and remove the support and heat exchanger.

GMV5 Home DC Inverter Multi VRF Units

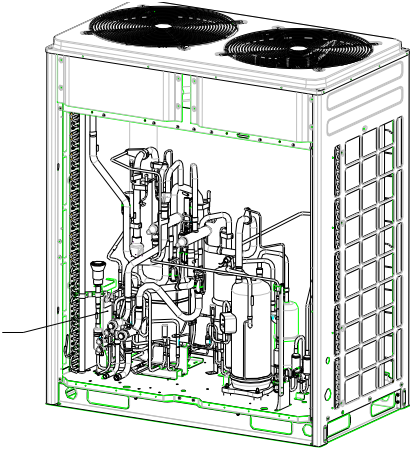
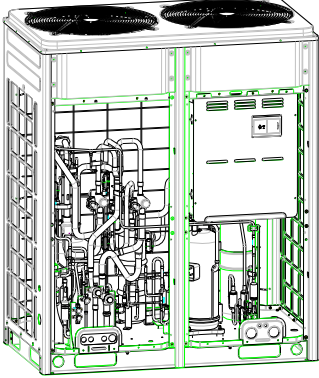
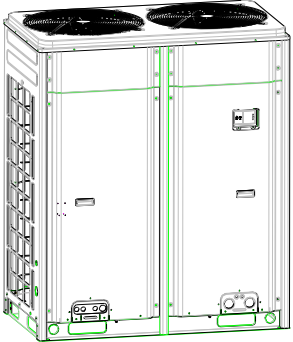
<p>5. Install a new plate type heat exchanger</p>		<ul style="list-style-type: none"> ●Screw the support of the plate type heat exchanger and fix the heat exchanger onto the chassis. ●Put the plate type heat exchanger according to the position of the suction and discharge pipes and weld the pipes with the heat exchanger. ●During welding, charge nitrogen into the pipes. The pressure should be controlled within 0.5 ± 0.1 kgf/cm₂ (relative pressure). Note: Prevent nearby parts from being burnt during welding.
<p>6. Fix and wire the electric box.</p>		<ul style="list-style-type: none"> ●Put the electric box back to original position and screw it up. ●Connect all the wires.
<p>7. Check and install the front panels.</p>		<ul style="list-style-type: none"> ●Check the parts and connecting wires. ●If no problem is found, hook the front panels and tighten the screws.

GMV5 Home DC Inverter Multi VRF Units

Hydro box.

Assembly and disassembly of hydro box

Precondition: No refrigerant exists in the pipeline system and the power supply has been disconnected.

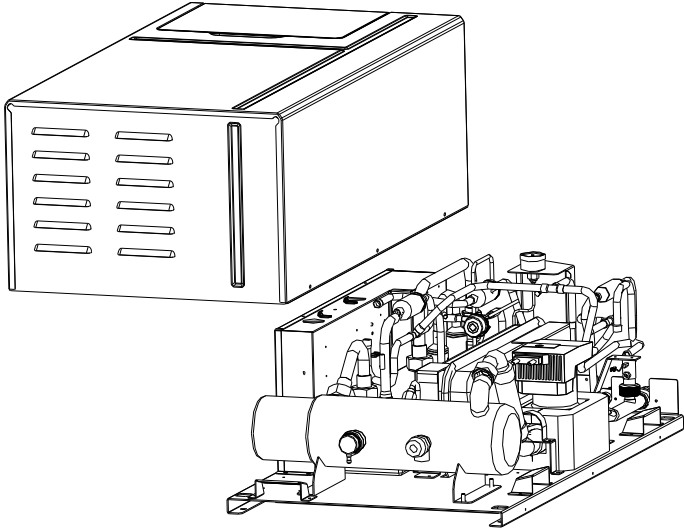
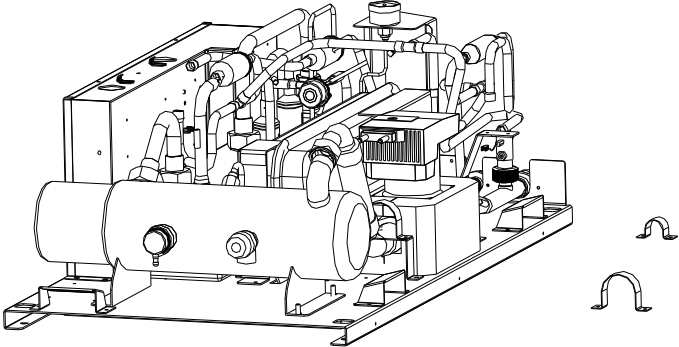
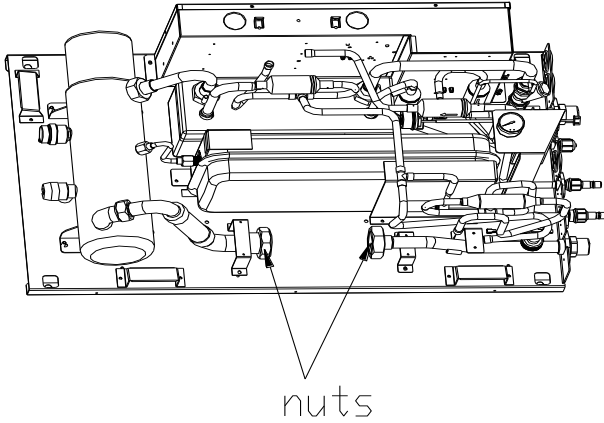
Step	Diagram	Operation Instruction
<p>1. Remove the panel.</p>		<ul style="list-style-type: none"> ● Unscrew the screws of panels with screwdriver and remove the panel; ● Note to lift the panel.
<p>2. Disassemble the parts of water pipe and pipe clip of electric heating water pipe.</p>		<ul style="list-style-type: none"> ● Unscrew the screws with screwdriver and take out the pipe clip.
<p>3. Disassemble the water pump.</p>		<ul style="list-style-type: none"> ● Unscrew the nuts in two ends of water pump. ● Remove sponge of water pump and take out the water pump.

GMV5 Home DC Inverter Multi VRF Units

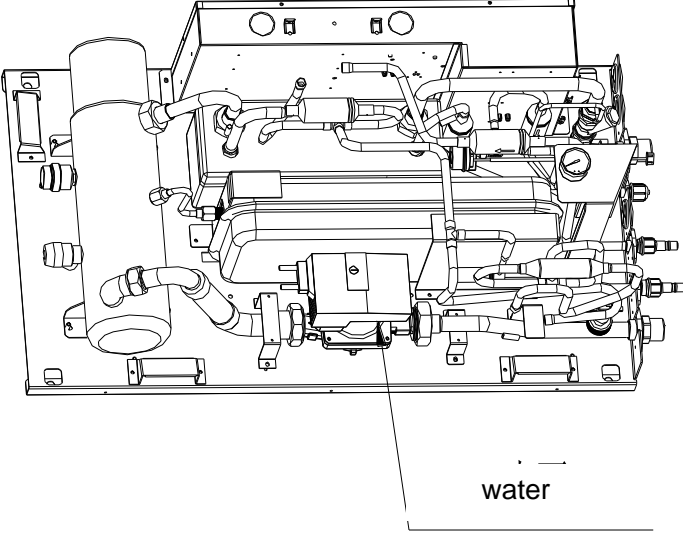
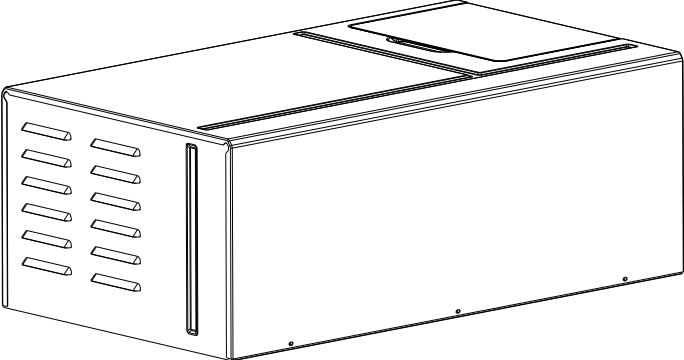
<p>4. Reassemble the water pump.</p>	 <p>water</p>	<ul style="list-style-type: none">●Cover thermal insulating cotton of water pump.●Put the water pump to the original position and install nuts.
<p>5. Recovery.</p>		<ul style="list-style-type: none">●Install pipe clips in order, cover with panel and install screws.

7. Common Maintenance

Routine checkup and maintenance can prolong service life of unit, please ask for professional personnel to conduct maintenance.

7.1 Outdoor Unit Heat Exchanger

Heat exchanger of outdoor unit should be washed regularly that at least once in two months. Use cleaner and nylon brush to remove dust and impurities; if there is compressed air source, use compressed air to remove the dust in the surface of heat exchanger. Please do not wash with tap water.

7.2 Drain Pipe

Regularly check if the drain pipe is blocked, ensure the condensate water is drained smoothly.

7.3 Notice at the beginning of use season

- (1) Check if there is blockage in air inlet and outlet of indoor and outdoor units;
- (2) Check if the grounding is reliable;
- (3) Check if the batteries of remote controller have been replaced;
- (4) Check if the air filter has been well installed;
- (5) After long-term closedown of unit, before restarting the unit, turn on the power switch of air conditioner 8 hours before starting operation, so as to conduct preheating of crankcase of outdoor compressor;
- (6) Check if outdoor unit is firmly installed, if there is any faults, please contact with Gree maintenance center.

7.4 Maintenance at the end of use season

- (1) Cut off general supply source of air conditioner unit;
- (2) Clean the filter and case of indoor and outdoor units;
- (3) Remove the dust and impurities of indoor and outdoor units;
- (4) If the outdoor unit gets rusty, smear with paint in rusty place to prevent it from expanding.

7.5 Parts Replacement

Acquire parts from nearby GREE agency or GREE franchiser.

7.6 System Leak Detection

Use soapy water to conduct leak detection, smear the soapy water in possible leaking point (welding points, spool, joints, etc.), if bubbles appear, it means there is leakage, please weld or repair.

If leaking point cannot be detected with soapy water, use electronic leak detector or charge 20Kgf/cm² of nitrogen into system and put it into water tank to detect leakage.

7.7 System Vacuum Pumping

- (1) Conduct vacuum pumping with vacuum pump, operation are as below:
 - 1) Unscrew the nut cap of refrigerant charging spout in inhalation tube;
 - 2) Connect low pressure soft tube of vacuum gauge to joint of refrigerant charging spout;
 - 3) Connect joint of intermediate tube of vacuum gauge to pressure soft tube, connect another end of soft tube to vacuum pump;
 - 4) Screw up the high pressure gauge and open the low pressure gauge, energize the vacuum pump;
 - 5) When the indicating needle of vacuum pump points at 15mmHg (gauge pressure), screw up the low pressure gauge and turn off the power supply, unscrew the soft tube in refrigerant charging spout and cover with nut cap.

Supplement and charge of refrigerant

- 6) Connect intermediate soft tube of refrigerant gauge to refrigerant tank, connect one end of blue soft tube of low pressure gauge to refrigerant charging spout of inhalation tube, lock it up, and then open the valve of refrigerant tank, open the valve besides low pressure gauge of refrigerant gauge and discharge for 5 seconds, and then screw up the joint of soft tube of refrigerant in three-way valve.

Wait for 3 minutes, after the unit is started up, we can see that the indicating needle of low pressure gauge is slowly increasing, and then unscrew the valve besides low pressure gauge and charge refrigerant (when the low pressure gauge displays 0.4~0.45Mpa, it means it is enough).

Notes:

- 7) The outdoor unit has been charged with refrigerant before leaving the factory, when connecting pipes on the spot, please charge supplementary refrigerant;
- 8) Check if liquid valve and air valve of outdoor unit have been completely closed;
- 9) When conducting air proofness and leak detection, please do not mix oxygen, acetylene and related dangerous gas into pipelines of refrigerant. In order to avoid danger, it is better to use nitrogen or refrigerant to conduct the test.
- 10) As shown below, draw off the air inside the indoor unit, hydro box and connecting pipe with vacuum pump from valve of outdoor unit.

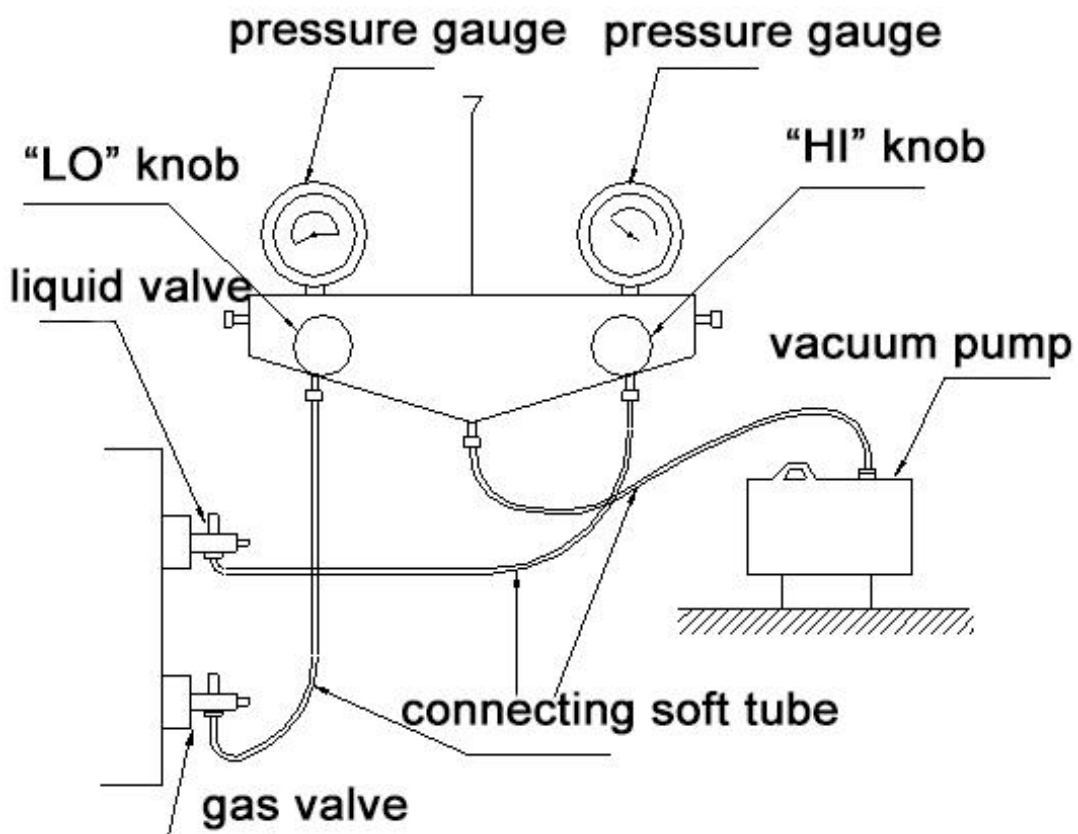

8.Exploded Views and List of Spare Parts

8.1 Outdoor Unit

Outdoor unit: GMV-S224W/A-X, GMV-S280W/A-X

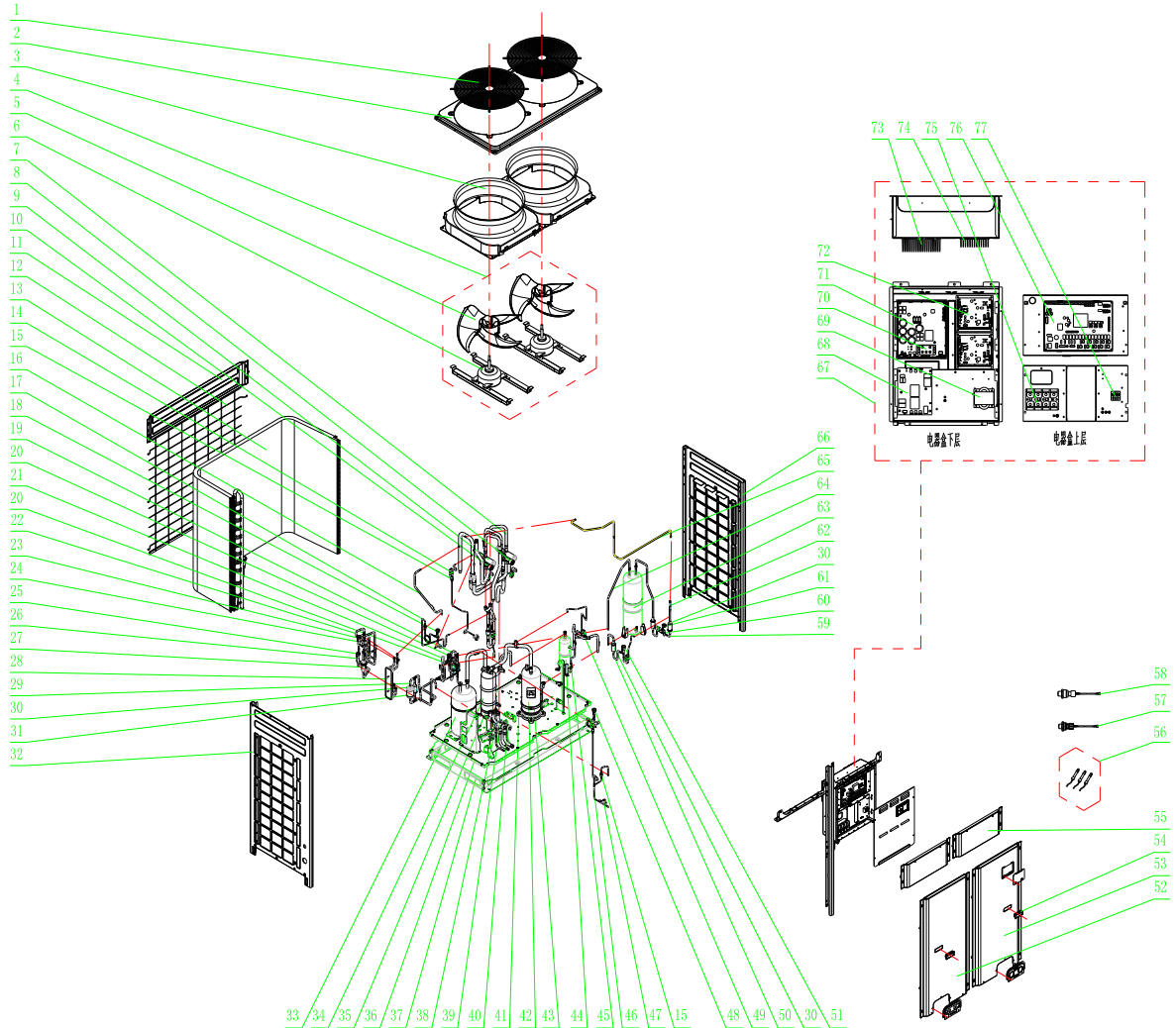

List of Parts

Outdoor unit: GMV-S224W/A-X, GMV-S280W/A-X

NO.	Name of part	Quantity	Part code
	Product code:CN853W0140		
1	Compressor and Fittings	1	204100008
2	Compressor Gasket	4	76814100007
3	Condenser Assy	1	0112410009601
4	Capillary tube	21	81020167
5	Temp Sensor Sleeving	1	5212423
6	Top Cover (front)	2	01264100004P
7	Upper Cover Plate (back)	1	01264100005P
8	Coping	1	01264100006P
9	Rear Grill	2	1574100002
10	Electric Box Cover	1	01264714P

GMV5 Home DC Inverter Multi VRF Units

11	Base Frame Sub-Assy	1	1284100122
12	Left Side Plate	1	01314712P
13	Right Side Plate	1	01314713P
14	Electric Box Assy	1	1394100374
15	Cable Cross Loop	1	26900000008
16	Main Board	1	30223000020
17	Main Board	1	30223000021
18	XY capacitor	1	33020201
19	XY capacitor	1	33030013
20	High Frequency Transformer	1	43110030
21	Fuse	1	46010055
22	Radiator	1	49010252
23	Main Board	1	30228000010
24	Terminal Board	1	42010264
25	Radiator	1	49010252
26	Filter Board	1	30228000015
27	Main Board	2	30229009
28	Radiator	1	49010252
29	Magnetic Ring	1	49010104
30	Magnetic Ring	6	49010109
31	Terminal Board	1	42010247
32	Terminal Board	1	42018000026
33	Reactor	1	4313017401
34	Rectifier	1	46010604
35	Radiator	2	49018000001
36	Radiator	1	49018000002
37	Bolt	1	70210051
38	Cable Clamp	21	71000151
39	Cable Tie	9	7102026504
40	Cable Cross Loop	1	76510021
41	Front Panel (left)	1	01544100003P
42	Front Panel (right)	1	01544100005P
43	Rear Grill	1	1574100001
44	Tube Clip	1	21400053
45	Tube Clip	1	21400055
46	Filter	1	7218603
47	4-way Valve	1	43000339
48	4-Way Valve Sub-Assy	1	4144100002
49	Temp Sensor Sleeving	2	5212423
50	Nozzle for Adding Freon	2	6120012
51	4-way Valve	1	43000339
52	Strainer	1	7415200002
53	One way Valve	1	7335210
54	Oil Balancing Tube Sub-assy 1	1	4224100273
55	Cut off Valve	1	7130239
56	Strainer	2	7415200002
57	Electromagnetic Valve	1	43000054
58	Discharge Tube Sub-assy	1	4534100081
59	Strainer	1	7415200002

GMV5 Home DC Inverter Multi VRF Units

60	Temp Sensor Sleeving	1	5210001
61	Oil Separator	1	7424100023
62	Pressure Protect Switch	1	4602000910
63	Cut off Valve	1	7334100012
64	Gas By-pass sub- assy	1	4634100012
65	Strainer	1	7415200002
66	Electromagnetic Valve	1	43000054
67	Temp Sensor Sleeving	1	5212423
68	Cut off Valve	1	7334100012
69	Connection Pipe	1	5024100671
70	Connection pipe sub-assy	1	5024100672
71	Connection pipe sub-assy	1	5024100728
72	Temp Sensor Sleeving	1	5212423
73	Plate-type Heat Exchanger Sub-Assy	1	904100012
74	Plate-type Heat Exchanger	1	904100005
75	Dry Filter Sub-Assy	1	7414100009
76	Temp Sensor Sleeving	1	5212423
77	Dry Filter	1	7218769
78	Gas Tube Filter	1	72190511
79	Electric Expansion Valve Sub-Assy	1	43044100092
80	One way Valve	1	4324001
81	Temp Sensor Sleeving	1	5212423
82	Bidirection Strainer	1	7210044
83	Discharge Charge Valve	1	7334100002
84	Electronic Expansion Valve	1	7334390
85	Electronic Expansion Valve	1	7334412
86	Electromagnetic Valve	1	43000054
87	Liquid Valve Sub-Assy	1	7304100002
88	Cut off Valve	1	7334100011
89	Discharge Charge Valve Sub-Assy	1	7334100047
90	One way Valve	1	4324001
91	Gas Tube Filter	2	72190511
92	Discharge Charge Valve	1	7334100002
93	Electromagnetic Valve	2	43000054
94	Low Pressure Survey Valve Sub-assy	1	7334100048
95	Cut off Valve	1	7130239
96	Strainer	1	7415200002
97	Capillary tube	1	81020143
98	Accumulator	1	7424100036
99	Oil Separator	1	742418601
100	Gas-liquid Separator	1	7424188
101	Diversion Circle	2	10474100002
102	Motor for Axial Fan Assy	2	15404100018
103	Motor Support Sub-Assy	2	01804771P
104	Motor Support Sub-Assy	1	1804771
105	Axial Flow Fan	1	10434100002
106	Axial Flow Fan nesting	1	2204102
107	Fan Motor	1	15704124
108	Handle	2	26904100016

GMV5 Home DC Inverter Multi VRF Units

109	Temperature Sensor Support	1	26904100025
110	Pressure sensor	1	32218000008
111	Pressure Sensor	1	32218000009
112	Sensor Sub-assy	1	39008000086G
113	Magnet Coil	1	4300040030
114	Magnet Coil	1	4300040064
115	Magnet Coil	1	4304000401
116	Magnet Coil	1	4304000413
117	Magnet Coil	1	4304000414
118	Magnet Coil	1	4304000415
119	Magnet Coil	1	4304000425
120	Magnet Coil	1	4304000428
121	Magnet Coil	1	4304000439
122	Electromagnetic Valve Sub-assy	1	43044100091
123	One way Valve	1	4324001
124	Gas Tube Filter	2	72190511
125	Electromagnetic Valve	1	43000055
126	Electromagnetic Valve Sub-assy	1	43044100100
127	Gas Tube Filter	1	72190511
128	Electromagnetic Valve	1	43000054
129	Electric expand valve fitting	1	4304413203
130	Electric Expand Valve Fitting	1	4304413204
131	M8Xφ22X8	4	70310014
132	Electric Heater(Compressor)	1	7651540713
133	Electrical Heater(Compressor)	1	7651873209

8.2 Hydro Box

Model: NRQD16G/A-S

Exploded View

GMV5 Home DC Inverter Multi VRF Units

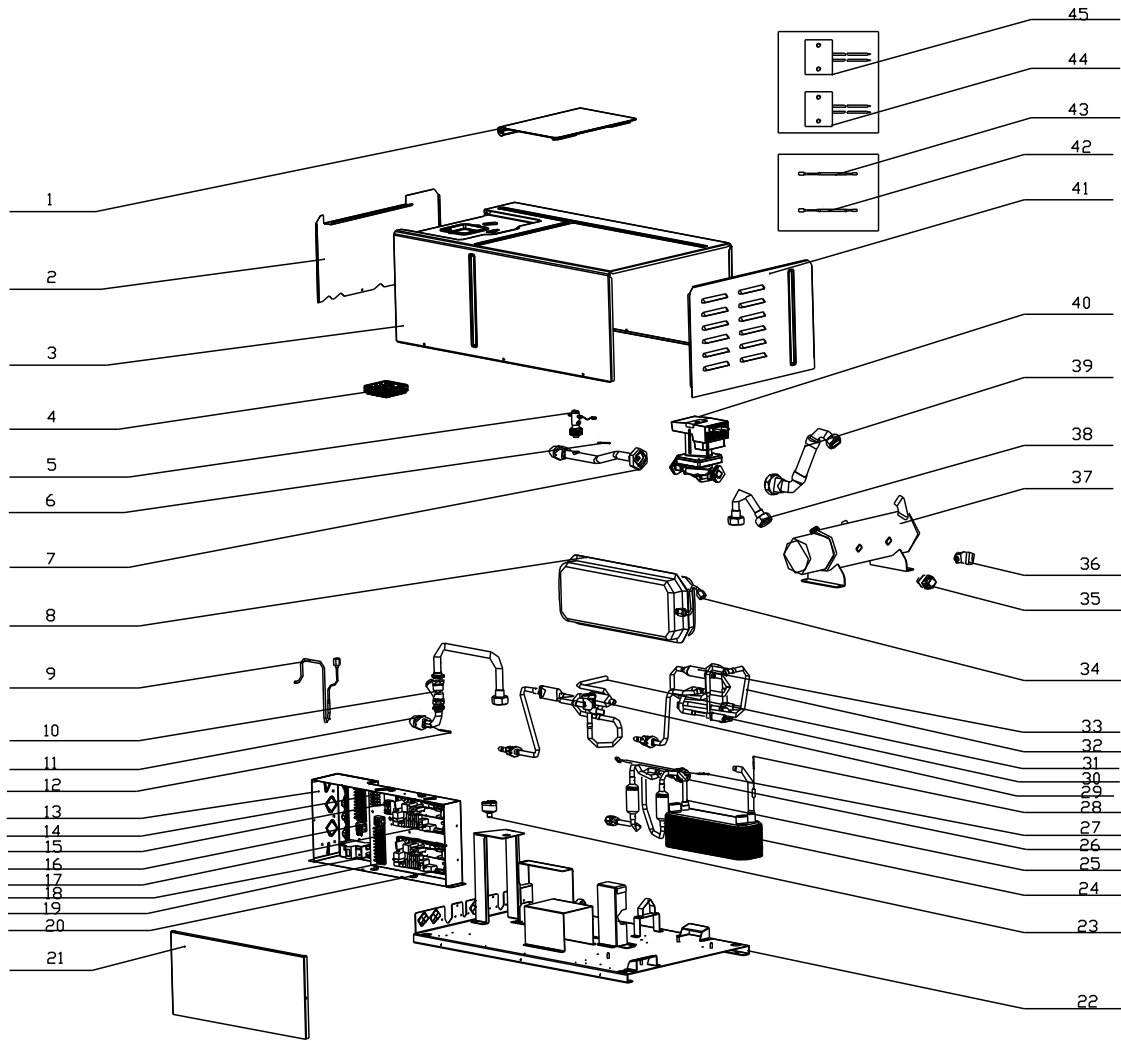

List of parts of NRQD16G/A-S

NO.	Name of part	Quantity	Part code
	Product code:CN700N0010		
1	Plate-type Heat Exchanger Assy	1	902800032
2	Plate-type Heat Exchanger	1	902812
3	Temp Sensor Sleeving	2	5212423
4	Electric Expansion Valve Sub-Assy	1	43042800046
5	Gas Tube Filter	2	72190511
6	Electronic Expansion Valve	1	7334503
7	Chassis Sub-assy	1	01194100002P
8	Electric Box Assy	1	1392800089
9	Guide Strip	0.1	1790001
10	Terminal Baffle	2	26118001
11	Main Board	1	30226000053
12	XY capacitor	2	33030013
13	Fuse	1	46010055
14	Main Board 2	1	30227000008
15	Fuse	1	46010055
16	Terminal Board	2	420101852
17	Terminal Board	1	42011103

GMV5 Home DC Inverter Multi VRF Units

18	Terminal Board	2	42011135
19	Terminal Board	1	4201800002601
20	Circuit breaker	1	4602800301
21	Insulation GasketC	2	70410523
22	Wire Clamp	3	71010102
23	Cable Cross Loop	2	76510021
24	Electric Box Cover	1	1422800035
25	Front Panel Assy	1	1542800039
26	Front panel cover	1	26902800006
27	Bottom Cover Plate	1	1262800013
28	Top Cover	1	1264100003
29	Front Panel	1	1542800004
30	Display Board	1	30296000024
31	Kid board	1	30276000005
32	Tube Clip	1	21400055
33	Discharge pipe Sub-Assy	1	4262800120
34	Temp Sensor Sleevng	1	5212423
35	Steam current Switch sub- Assy	1	45028065
36	Enter Water Pipe Assy	1	4262800121
37	Temp Sensor Sleevng	1	5212423
38	Strainer	1	7412808
39	Water inlet pipe sub-assy(electric heating)	1	4262800123
40	Outlet Water Pipe Sub-Assy	1	4362917
41	pipe connector	2	6652805
42	Auto Air Outlet Valve	1	7108208
43	Auto Air Outlet Valve	1	7108208
44	pressure maintaining valve	1	7333700052
45	Relief Valve	1	7382814
46	Expansion Drum	1	7422800004
47	Electric Heater	1	32000003
48	Temperature Sensor	1	390000372
49	Temperature Sensor	1	3900012121
50	Temperature Sensor	1	390001921
51	Temperature Sensor	1	39000283
52	Temperature Sensor	2	3900028301
53	Tube sensor	1	39000284G
54	Magnetic Ring	1	49010104
55	Magnetic Ring	1	49010109
56	Magnet Coil	1	4304000408
57	Magnet Coil	1	4304000431
58	Electromagnetic Valve Sub-assy	1	43042800047
59	Gas Tube Filter	2	72190511
60	Electromagnetic Valve	1	43000073
61	Electromagnetic Valve Sub-assy	1	43042800048
62	One way Valve	1	7130118
63	Discharge Charge Valve	1	7334100002
64	Electromagnetic Valve	1	43000073
65	Water Pump	1	43138223
66	Cable Cross Loop	3	76515202

Chapter 6 Care

1. Care

Routine checkup and maintenance can prolong service life of unit, please ask for professional personnel to conduct maintenance.

1.1 Outdoor Unit Heat Exchanger

Heat exchanger of outdoor unit should be washed regularly that at least once in two months. Use cleaner and nylon brush to remove dust and impurities; if there is compressed air source, use compressed air to remove the dust in the surface of heat exchanger. Please do not wash with tap water.

1.2 Drain Pipe

Regularly check if the drain pipe is blocked, ensure the condensate water is drained smoothly.

1.3 Notices at the Beginning of Use Season

- (1) Check if there is blockage in air inlet and outlet of indoor and outdoor units;
- (2) Check if the grounding is reliable;
- (3) Check if the batteries of remote controller have been replaced;
- (4) Check if the air filter has been well installed;
- (5) After long-term closedown of unit, before restarting the unit, turn on the power switch of air conditioner 8 hours before starting operation, so as to conduct preheating of crankcase of outdoor compressor;
- (6) Check if outdoor unit is firmly installed, if there is any faults, please contact with Gree maintenance center.

1.4 Notices at the End of Use Season

- (1) Cut off general supply source of air conditioner unit;
- (2) Clean the filter and case of indoor and outdoor units;
- (3) Remove the dust and impurities of indoor and outdoor units;
- (4) If the outdoor unit gets rusty, smear with paint in rusty place to prevent it from expanding.

1.5 Parts Replacement

Acquire parts from nearby Gree agency or Gree franchiser.



Notes:

When conducting air proofness and leak detection, please do not mix oxygen, acetylene and related dangerous gas into pipelines of refrigerant. In order to avoid danger, it is better to use nitrogen or refrigerant to conduct the test.

Chapter 7 Monitoring Software

1 Function Introduction

With the rapid development of building complex, more and more central air conditioners in various models are used in different places, resulting in inconvenience for the management of air conditioners. Integrating with telecommunication technology and computing software, Gree Commissioning Tool Kits can realize the comprehensive monitor, control and commissioning on central air conditioners. It is an efficient solution for the management of central air conditioners that are separated in different parts of a building. Administrator doesn't need to control every unit on site, but rather controls the units by just sitting in front of a computer. This will not only improve the productivity, but also reduce cost on human resources, property and management.

Gree Commissioning Tool Kits can monitor and control the 2nd generation of Gree Multi VRF. User can monitor and control units by monitoring the computer. This software is an efficient tool for the intelligent air conditioning management as well as installation and after-sales service and commissioning. It can debug units and control units' operation status quickly and conveniently. It will not only improve the productivity but also reduce the difficulty and cost of commissioning and maintenance, providing better and faster service to customers.

2 Connection of Computer and Units

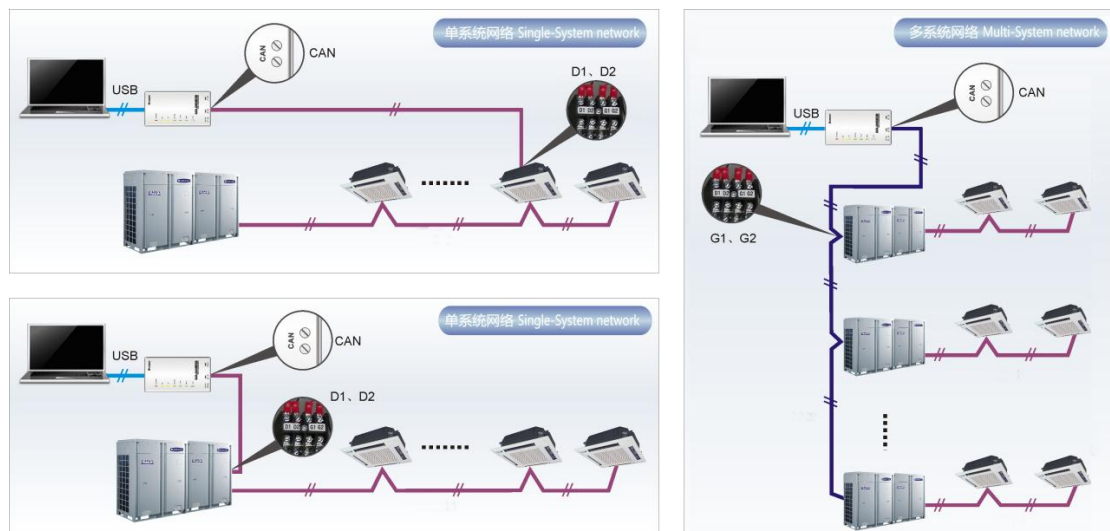

It can be connected with single-system network or multi-system network. In the single-system network, indoor units or outdoor units are connectable, while in the multi-system network, only the master outdoor unit can be connected.

Instructions on Connection Diagram

Seen from the diagram, Gree commissioning network is made up of 3 parts:

The 1st part is the monitoring computer, including Gree debugger and Gree USB converter driver that are installed in the computer.

The 2nd part is Gree USB converter, which is to convert the air conditioning communication into computing communication. This part is made up of Gree USB data converter and USB data

wire.

The 3rd part is air conditioners, including outdoor units, indoor units and the connection wires. If connection wire is not long enough, it's OK to connect via the patching board of the commissioning tool kits. In a single-system network, both indoor units and outdoor units can be connected, while in a multi-system network, only the master outdoor unit can be connected.

3 Hardware Introduction

3.1 List of parts

Name	Model	Material No.	Remarks
Gree USB data converter	MC40-00/B	30118027	Convert the air conditioning communication into computing communication
Gree Commissioning Tool Kits (CD-ROM)	DG40-33/A(C)	3640000003	Include Gree debugger, monitoring software, USB driver and USB converter configuring software.
USB wire	\	40020082	Wire connecting computer's USB interface and converter
Communication board	\	30118015	This board can be used when units are far from the computer.
Board connection wire (1m)	\	4001023229	4-core wire connecting units and converter
Board connection wire (5.5m)	\	4001023214	4-core wire connecting units and converter
Instruction manual	\	64134100023	Instruction manual

3.2 Gree USB Data Converter

3.2.1 Functions Introduction

Gree USB data converter will convert the RS485, HBS and CAN communication within the air conditioners into the communication that is recognizable by computer's USB interface.

3.2.2 Appearance

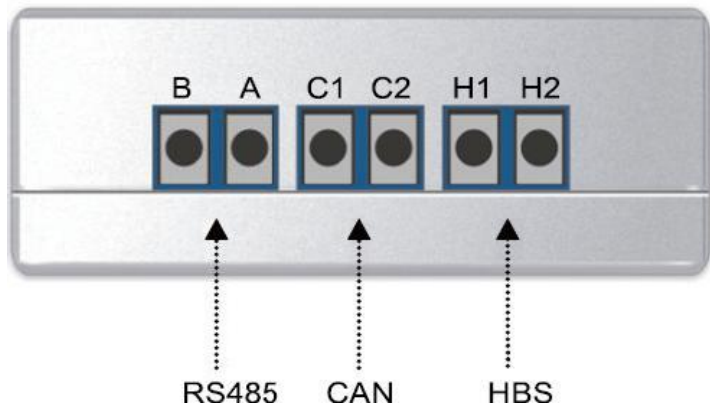
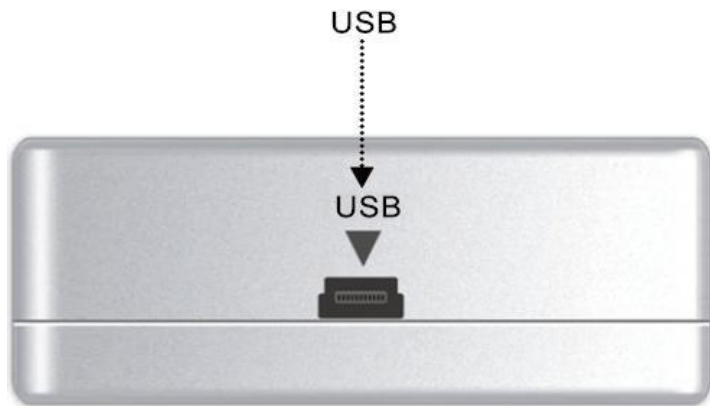
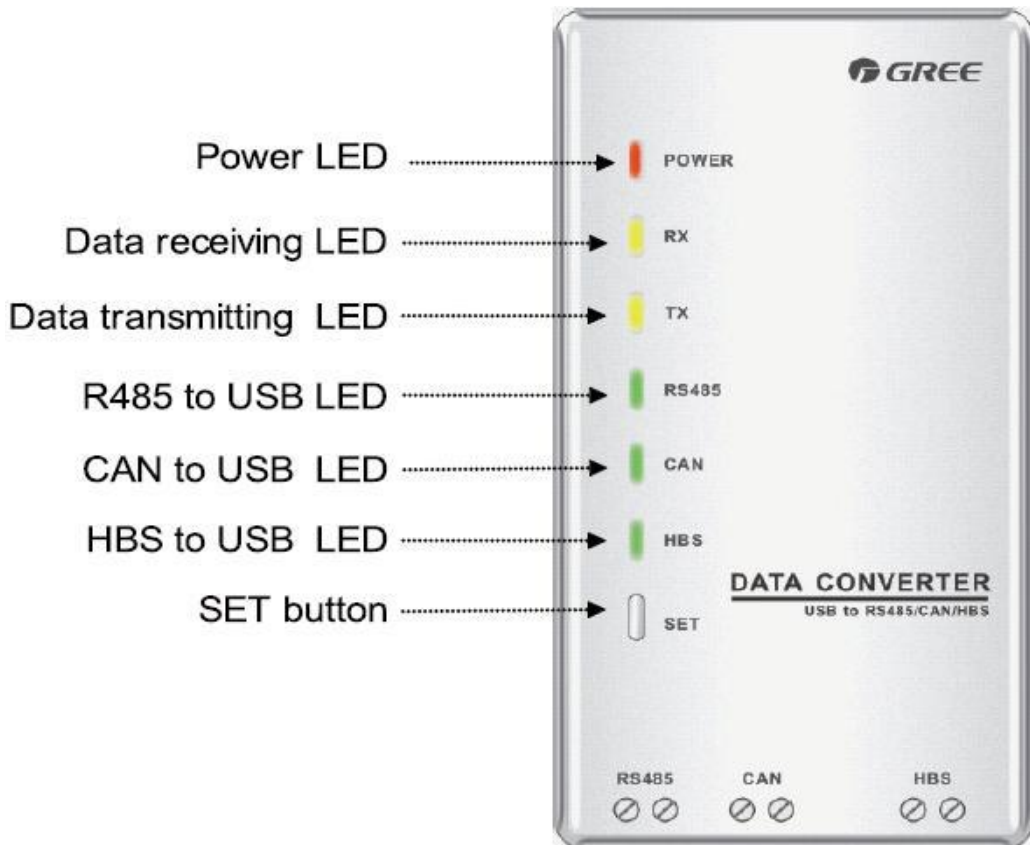

3.2.3 Operation Instruction

- Power LED: a red light. If the red light is on, it indicates normal power supply. If the red light is off, it indicates the power supply of converter is not normal.
- Communication LEDs: yellow lights. When converter is working and the computer is transmitting data, the TX data transmitting light will be flickering. When units are uploading data to the computer, the RX data receiving light will be flickering.
- Function LEDs: green lights
- When converter is under RS485 data transferring mode, the function LED of RS485 to USB will be on.
- When converter is under CAN data transferring mode, the function LED of CAN to USB will be on.
- When converter is under HBS data transferring mode, the function LED of HBS to USB will be on.
- USB interface: connect USB data wire.
- CAN interface: When converter is under CAN communication mode, connect air conditioner's CAN data interface. CAN interface exhibits no polarity (A and B are equal).
- HBS interface: When HBS converter is under HBS communication mode, connect air conditioner's HBS data interface. HBS interface exhibits no polarity (This interface is not yet available for Gree debugger and the monitoring software).
- RS485 interface: When RS485 converter is under RS485 communication mode, connect air conditioner's RS485 data interface. RS485 interface exhibits polarity and terminal A and B are different.

3.2.4 Installation Notices

- Install indoors. To avoid collision, it is suggested to place it in the monitoring room together with the computer.
- No need of power supply. Power is supplied through computer's USB interface.

3.3 Communication Board

Communication board is mainly used for transferring data. It functions similar with a patching board. If units are far away from the monitoring computer, communication board can be used for connection.

3.4 Communication Wire

3.4.1 USB Wire

- Connect USB wire with computer's USB interface at one end and with the USB interface of USB data converter at the other end, as indicated below:

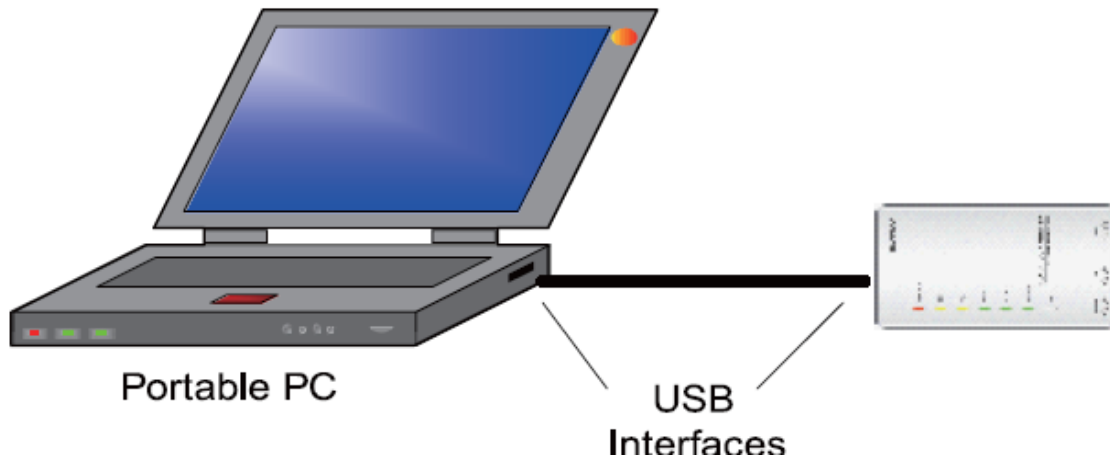

3.4.2 Board Connection Wire

- There are 2 board connection wires supplied for the commissioning tool kits. One is 1 meter long and the other is 5.5 meters long. They are only different in length. One end of the wire shall connect with air conditioner communication interface and the other end shall connect with Gree USB converter CAN interface. As shown below, the wire can be connected to the communication interface of outdoor unit or the communication interface of indoor unit:

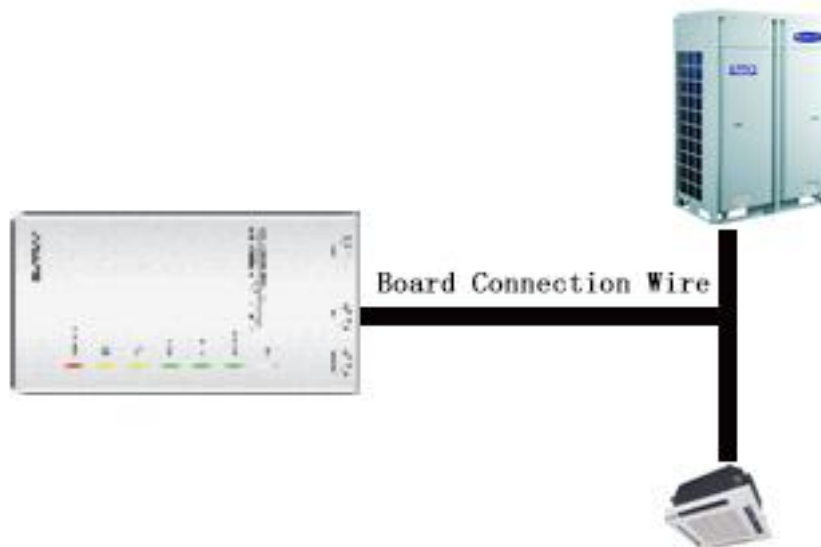

4 Software Introduction

4.1 Installation Requirements

4.1.1 Computer Configuration

Memory	1 GB at least 2 GB or larger is preferred
Hard Disc	10 GB available

CPU	<p>Core 2 or higher</p> <p>1 GHz at least</p> <p>2 GHz or above is preferred</p>
Operation System	<p>Windows Server 2003 SP3 or later versions</p> <p>Windows XP SP3 or later versions</p> <p>Windows Vista</p> <p>Windows 7</p>

4.1.2 CD Playing

Make sure you have administrator access to the computer and there is a CD-ROM in the computer. Put the CD into the CD-ROM. If it's automatically running, then the following display will be shown. Or double-click the file "Launcher.exe".



For the first time to use Gree Commissioning Tool Kits, install these programmes: .Net Framework 4.0, USB Converter Driver, Access Driver (necessary for versions older than OFFICE 2007), Gree Debugger.

4.2 Installation Flowchart

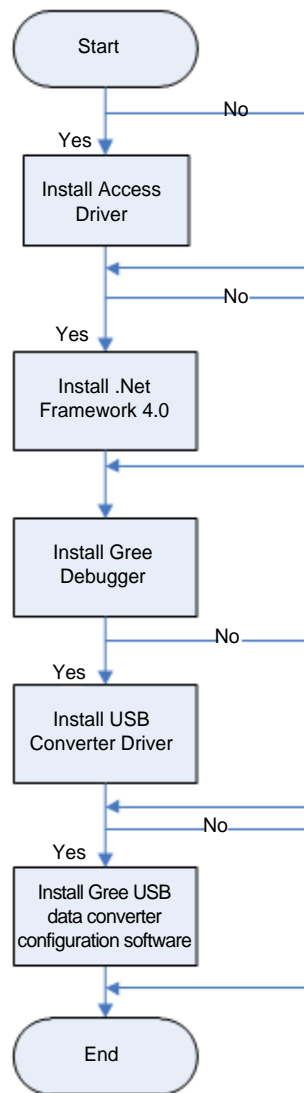

This flowchart describes basically the software installation process. See below for details.

4.3 Installation Procedure

4.3.1 Install .Net Framework 4.0

- If your computer has installed .Net Framework 4.0 or later versions, there's no need to install again. Otherwise, click "Install .Net Framework 4.0".



- Extracting files

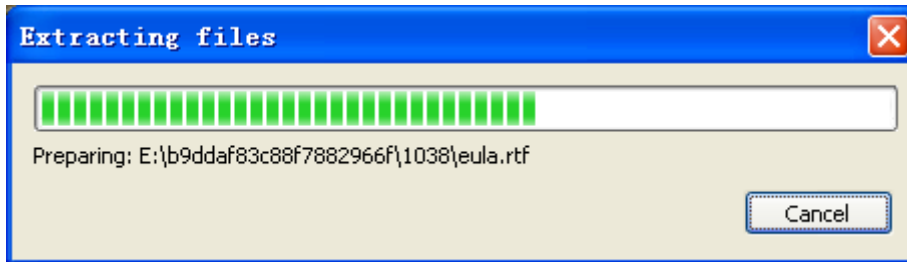

- Click and select "I have read and accept the license terms". Then click "Install".

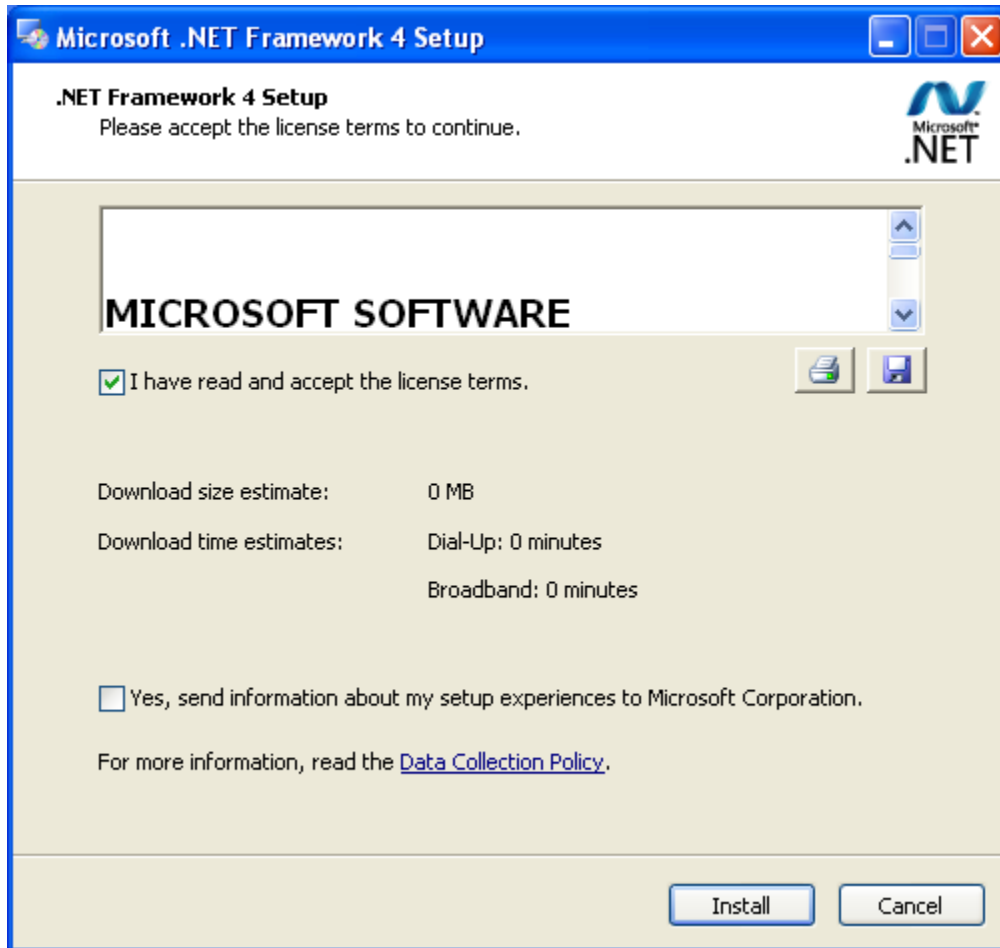

- Installation is in progress.

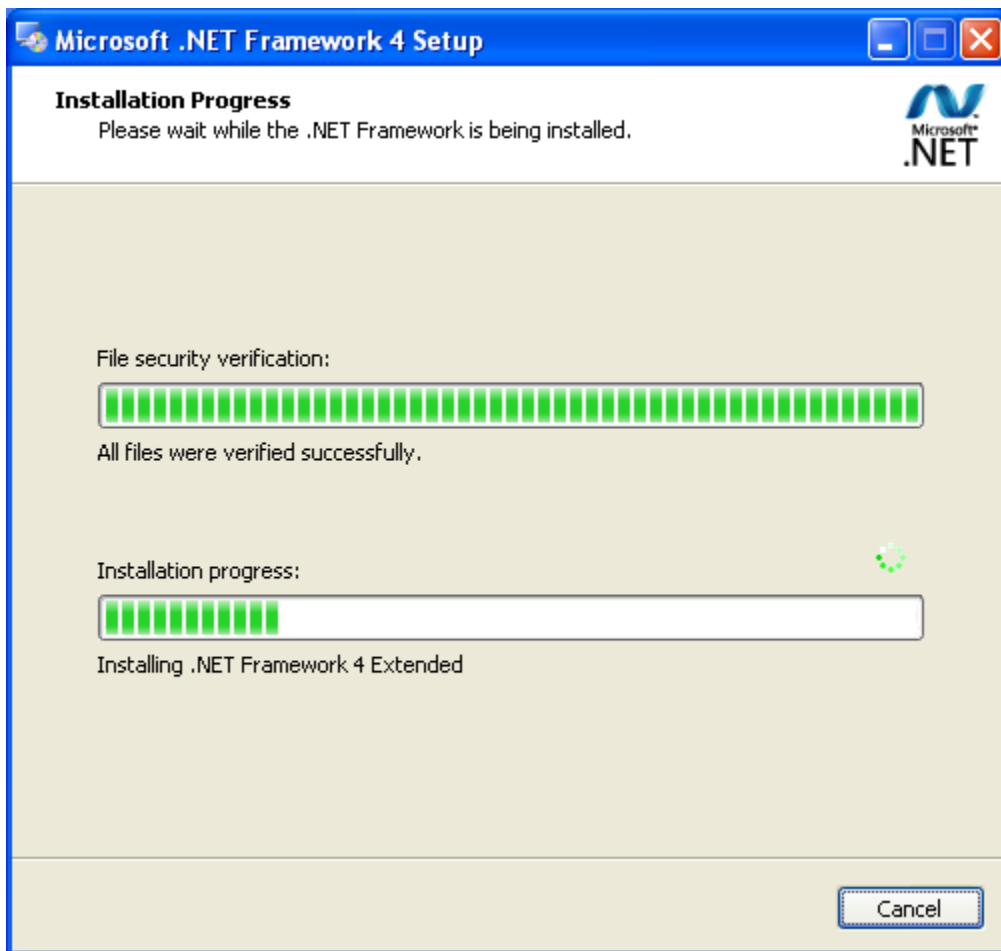

- Click "Finish" to complete the installation.

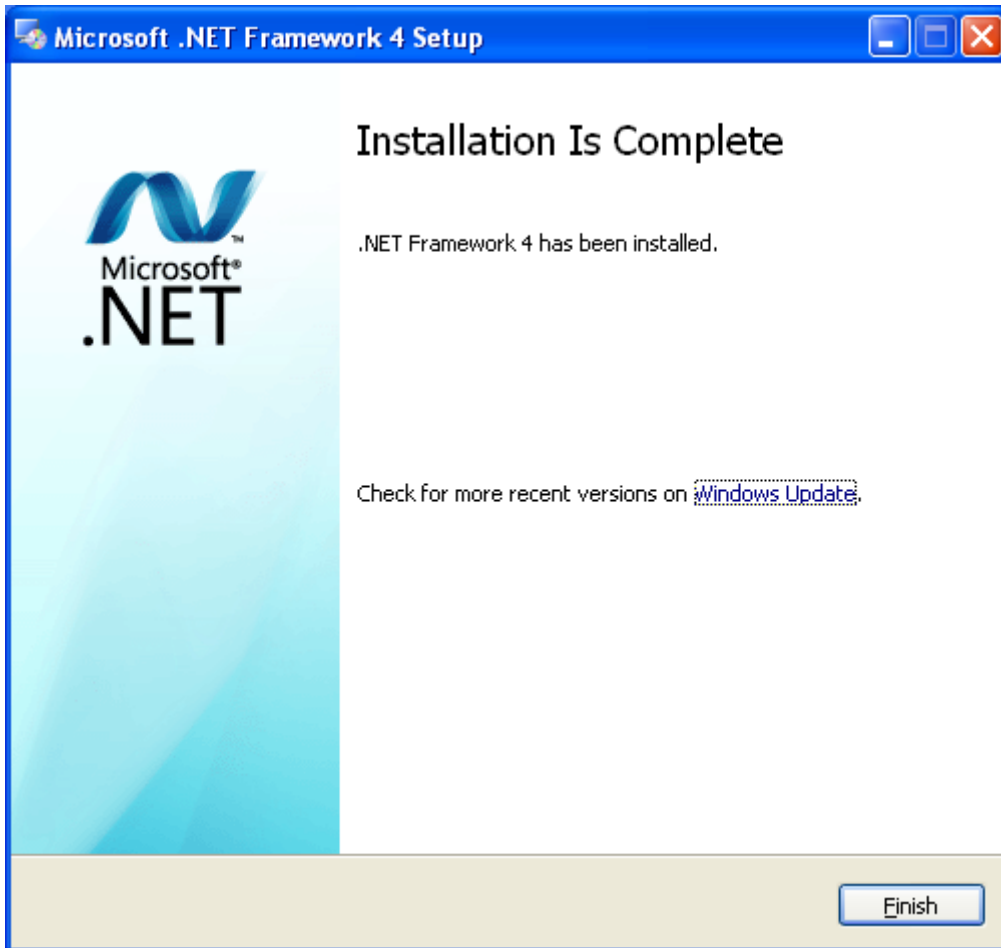

4.3.2 Install Access Driver

- Before operating Gree commissioning software, please first install Access Driver (necessary for versions older than OFFICE 2007). Click "Install Access Driver".



- Click "Next".

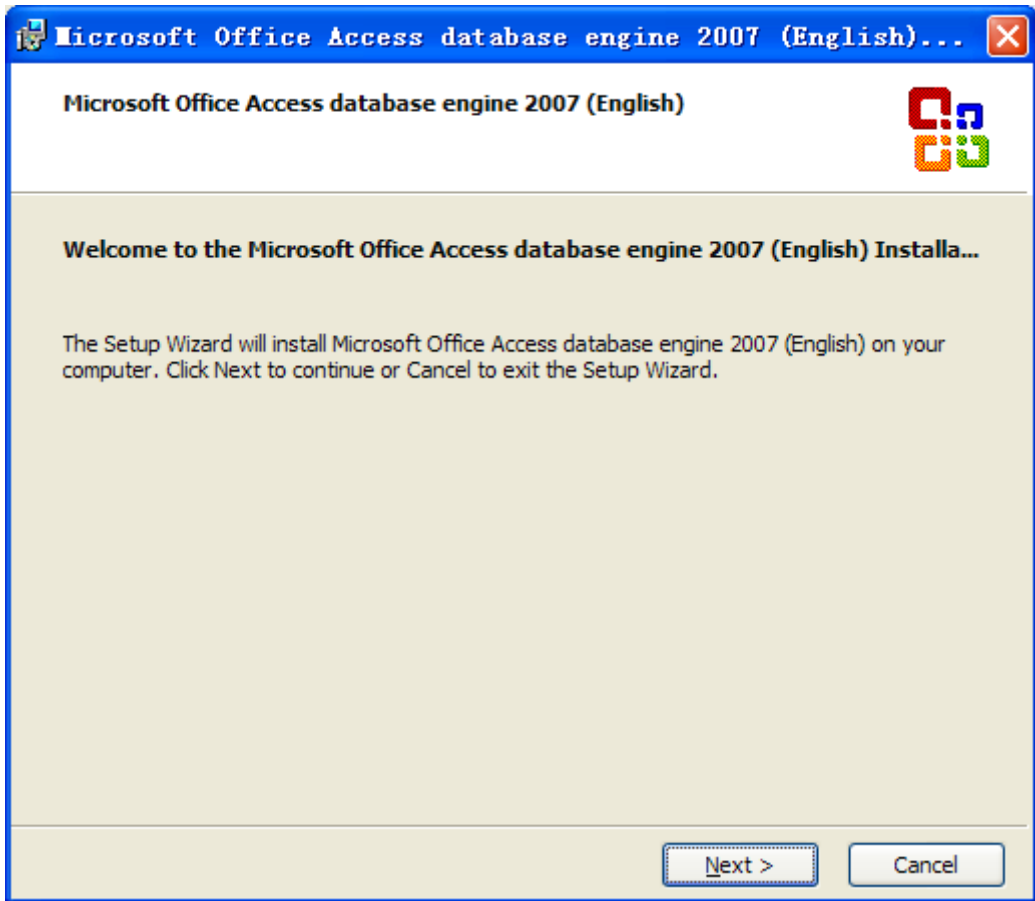

- Tick "I accept the terms in the License Agreement" and then click "Next"



- Click "Browse" to change the default folder to the expected one, or click "Install" to

continue the installation.

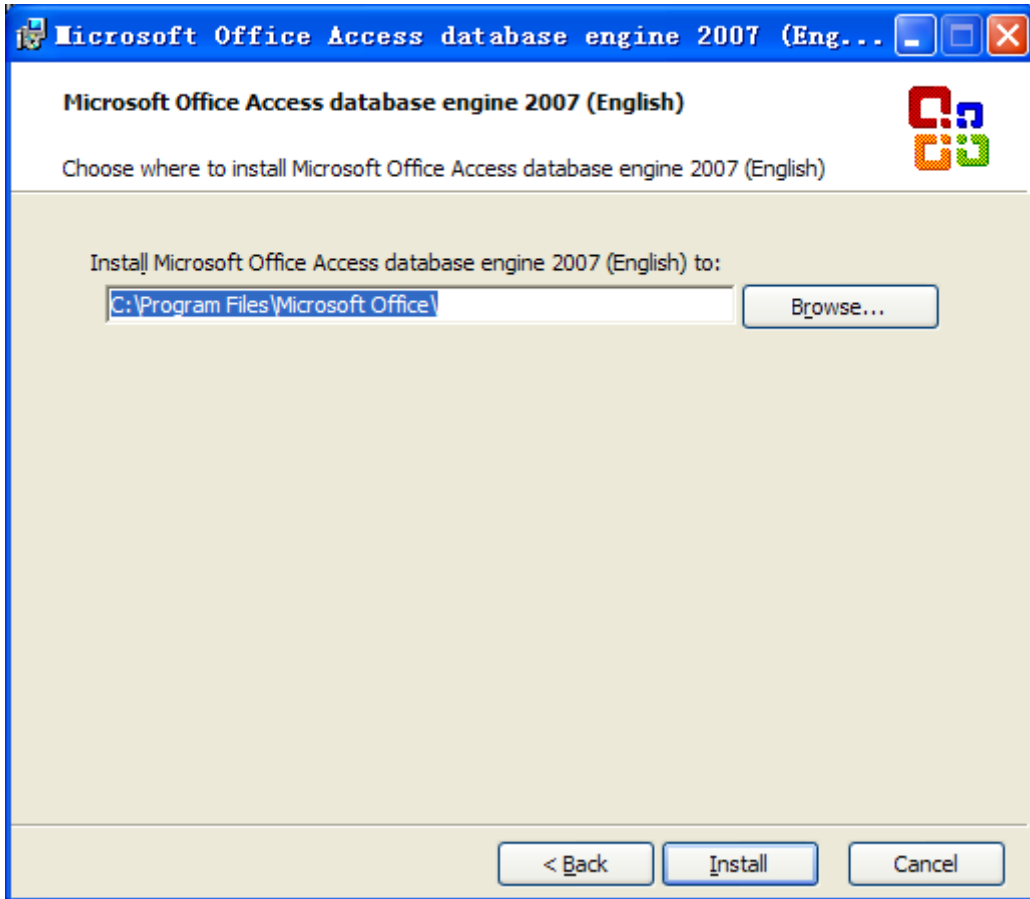

- Installation is in progress.

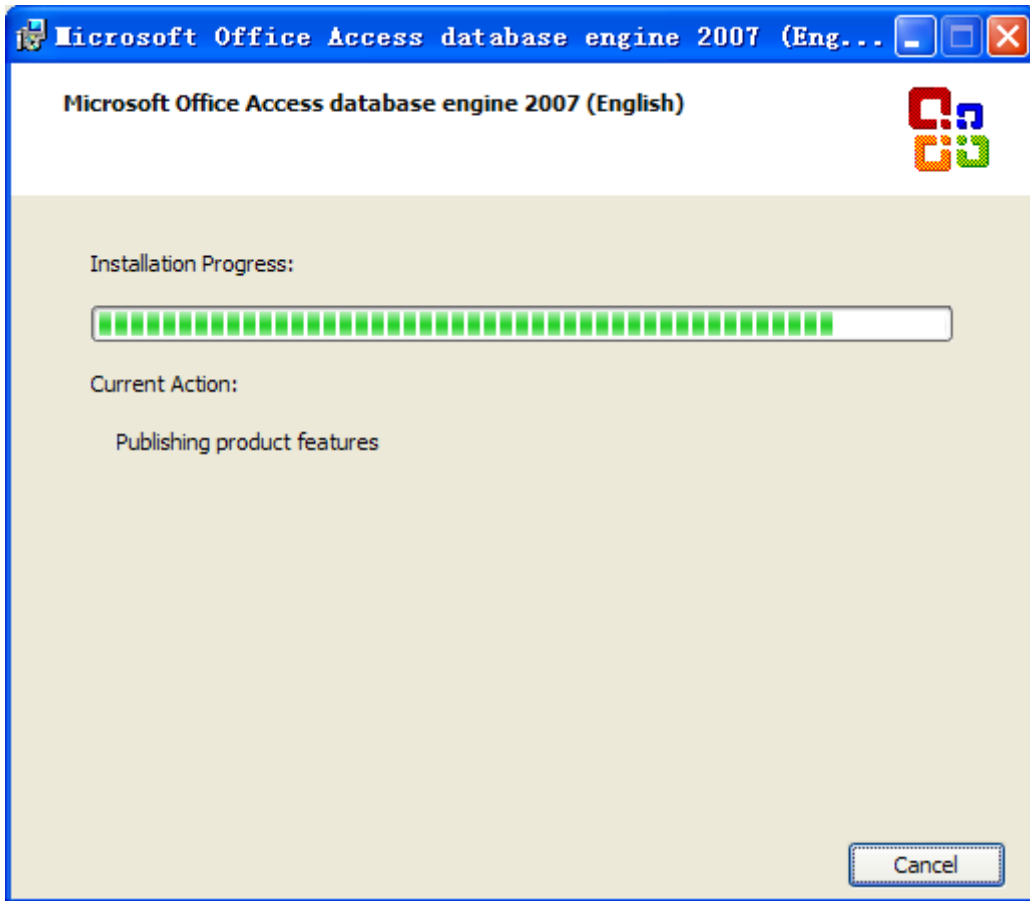

- Click "Ok" to complete the installation.



4.3.3 Install Gree Debugger

- Before installing Gree debugger, make sure that your computer is installed with .Net Framework 4.0 or later versions. Then click "Install Gree Debugger".



- Click "Next".

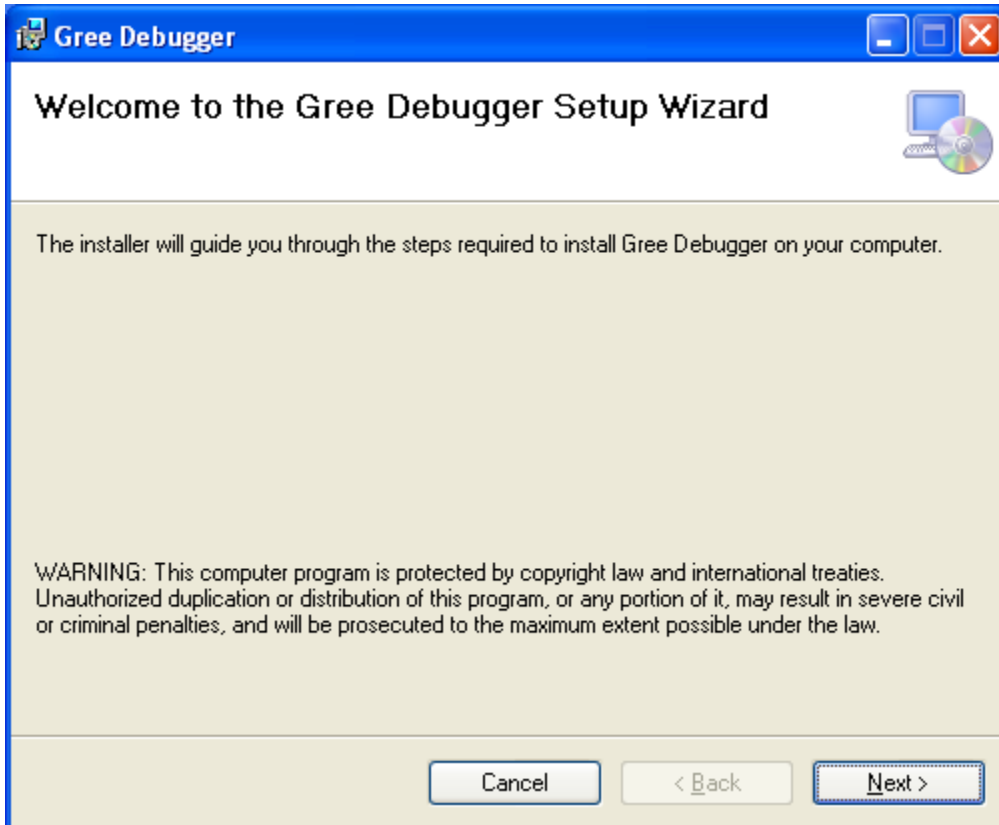

- Click "Browse" to select installation folder. If no change is needed for the folder, click "Next" to continue the installation.

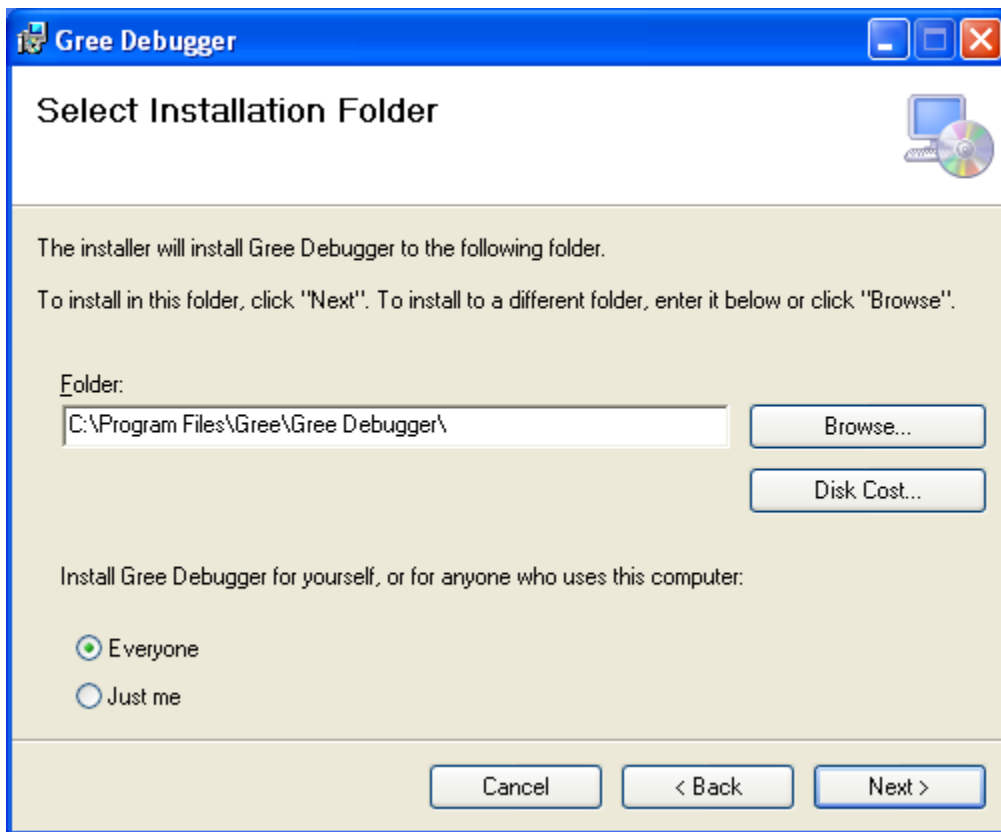

- "Click "Next".

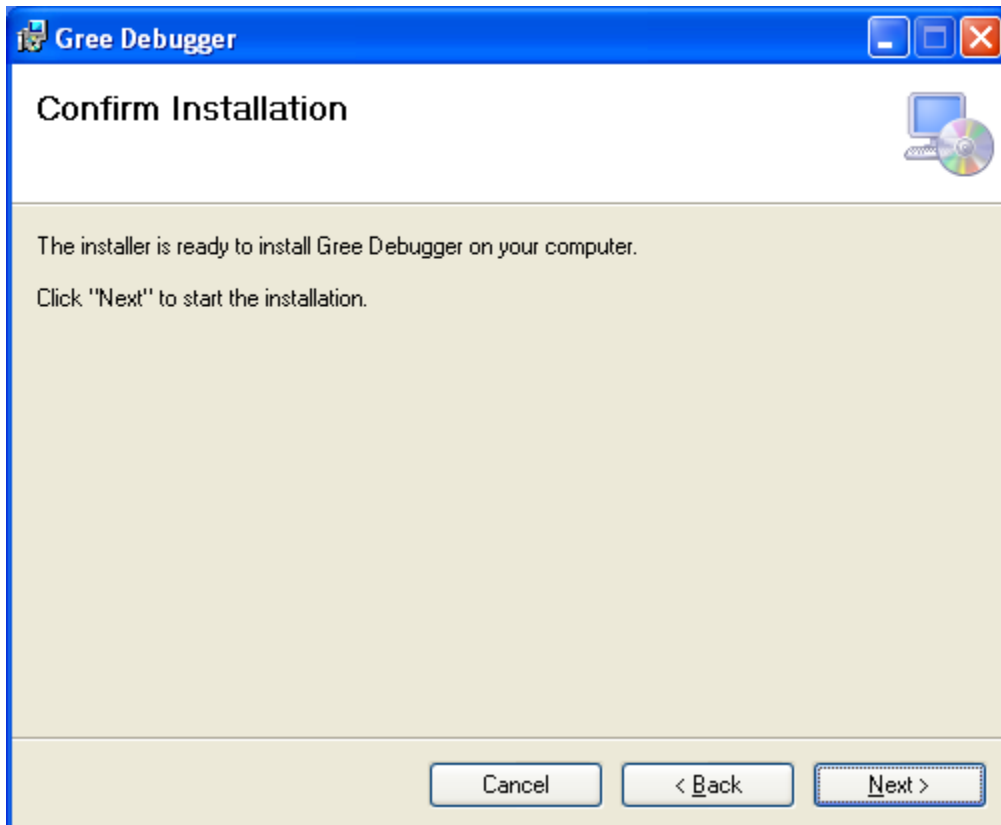

- Installation is in progress.

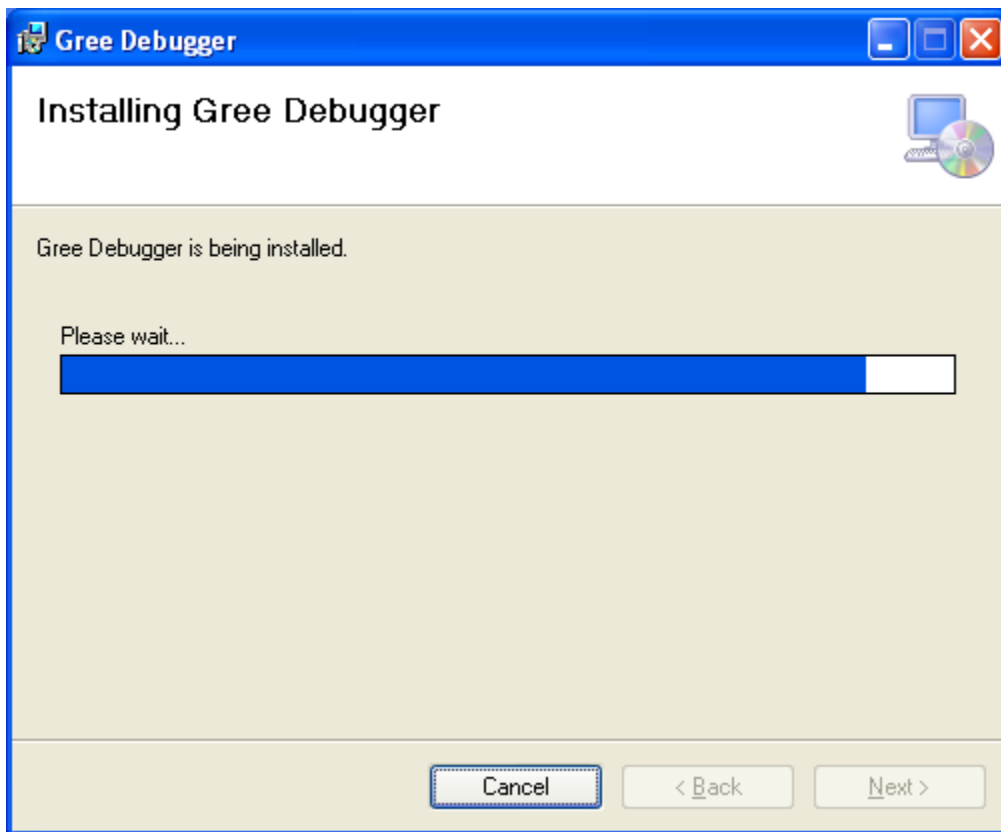

- Click "Close" to complete the installation.

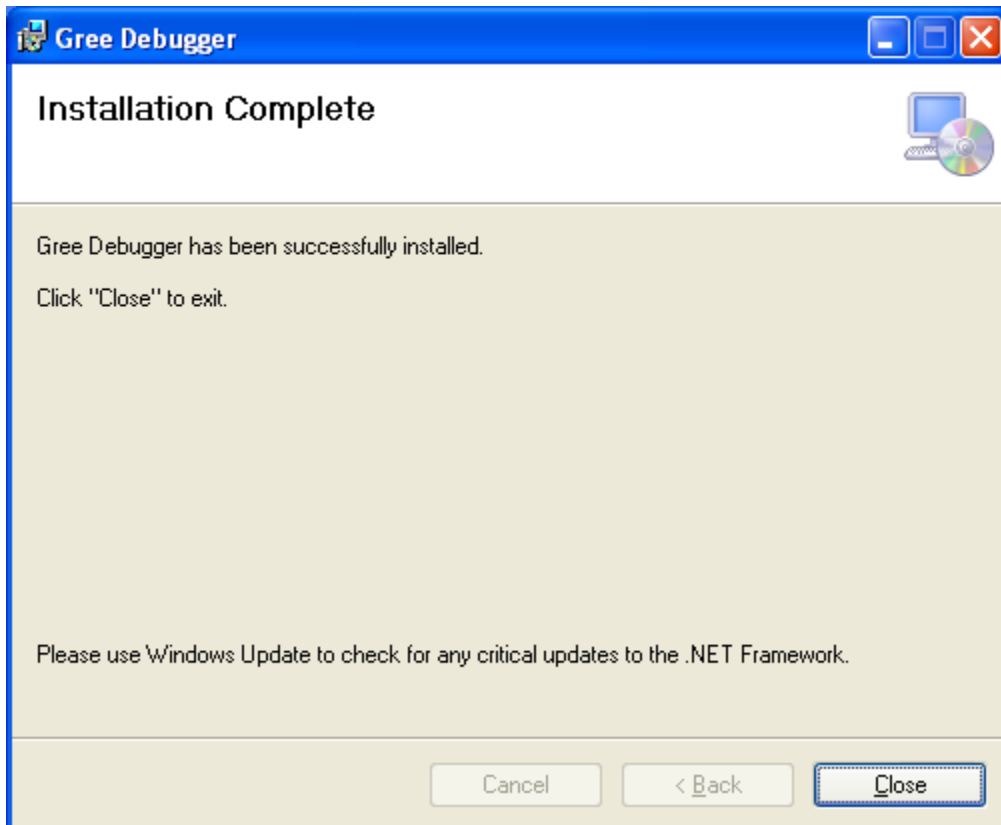

4.3.4 Install USB Converter Driver

If USB converter driver is already installed in your computer, you can skip this step. Otherwise, click "Install USB Converter Driver".



- Then the following installation window will be shown.

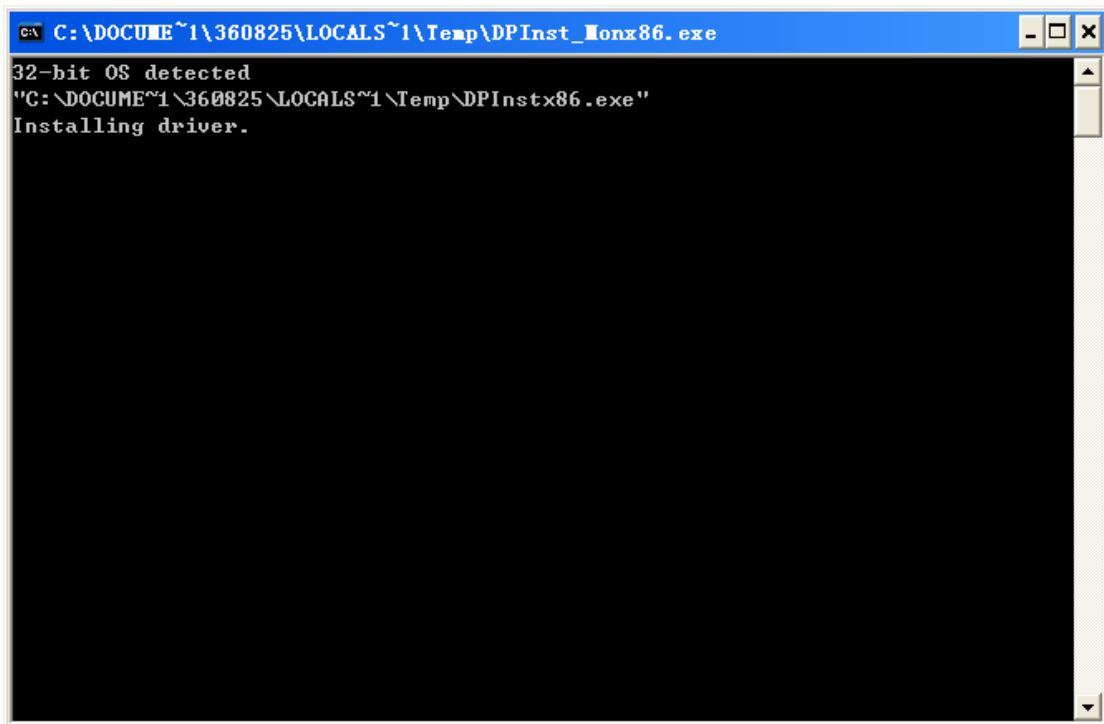

- This window will exit after installation is finished.

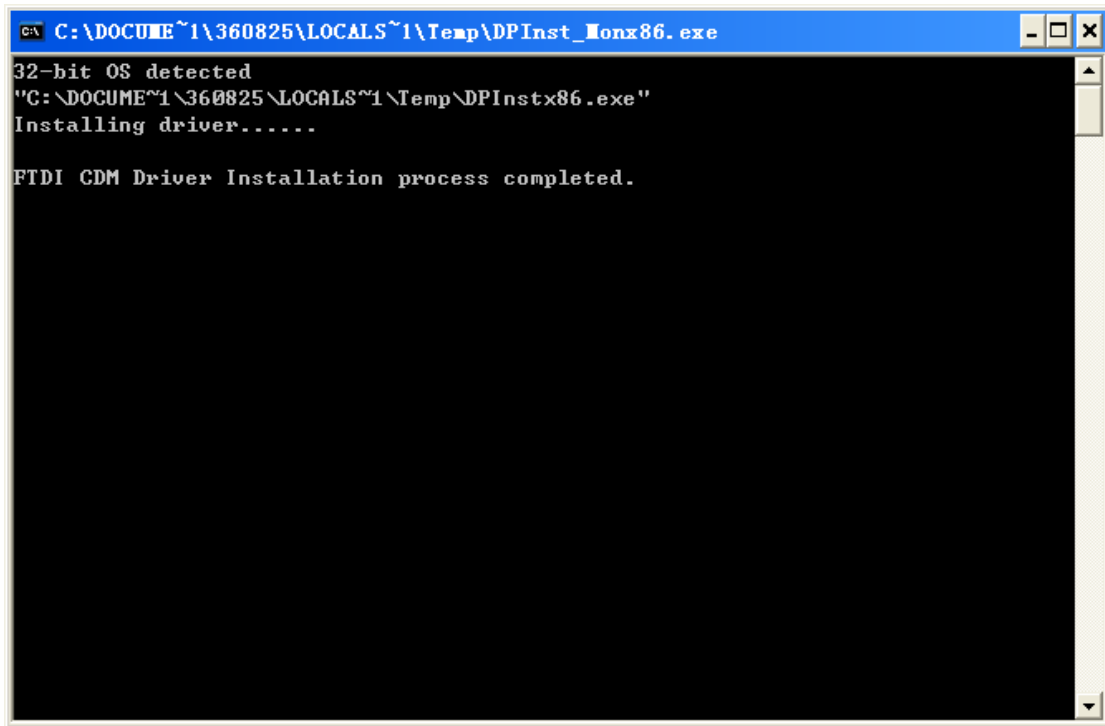

4.3.5 Install Gree USB Data Converter

If converter baud rate is needed to be set, then converter configuring software must be installed. Click "Install Gree USB Data Converter".



- Then select the setup language. You can choose Chinese "simplified", Chinese "traditional" or English. Then click "OK".

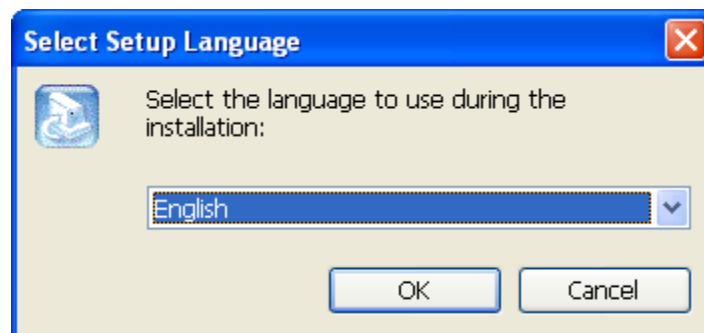

- Click "Next".

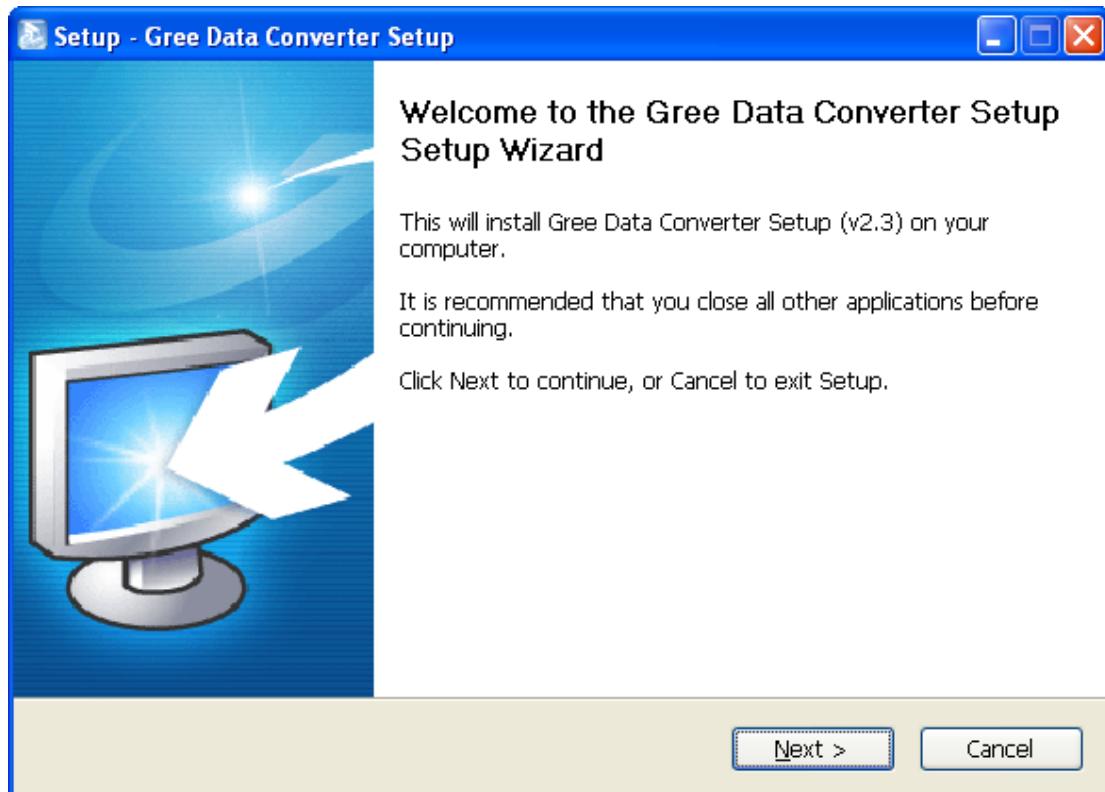

- Tick "I accept the agreement". Then click "Next" to continue installation.

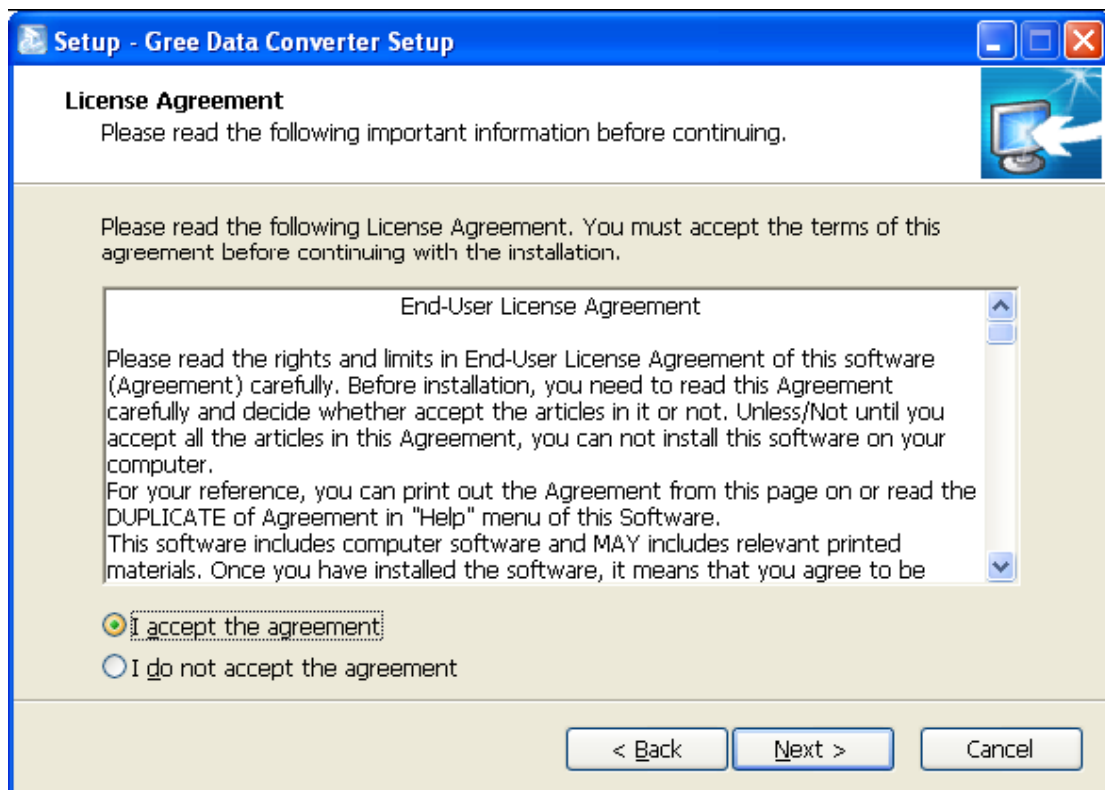

- Click "Browse" to select your expected installation folder. Click "Next" to continue.

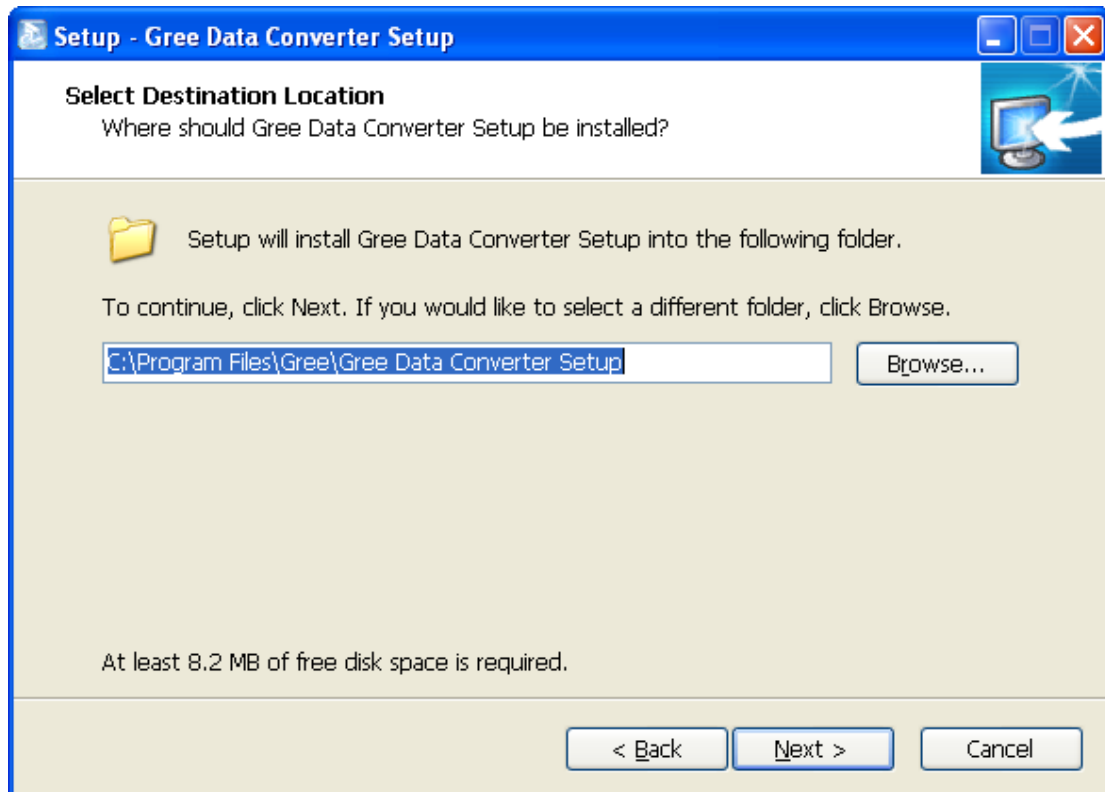

- Click "Browse" to change folder. Click "Next" to continue.

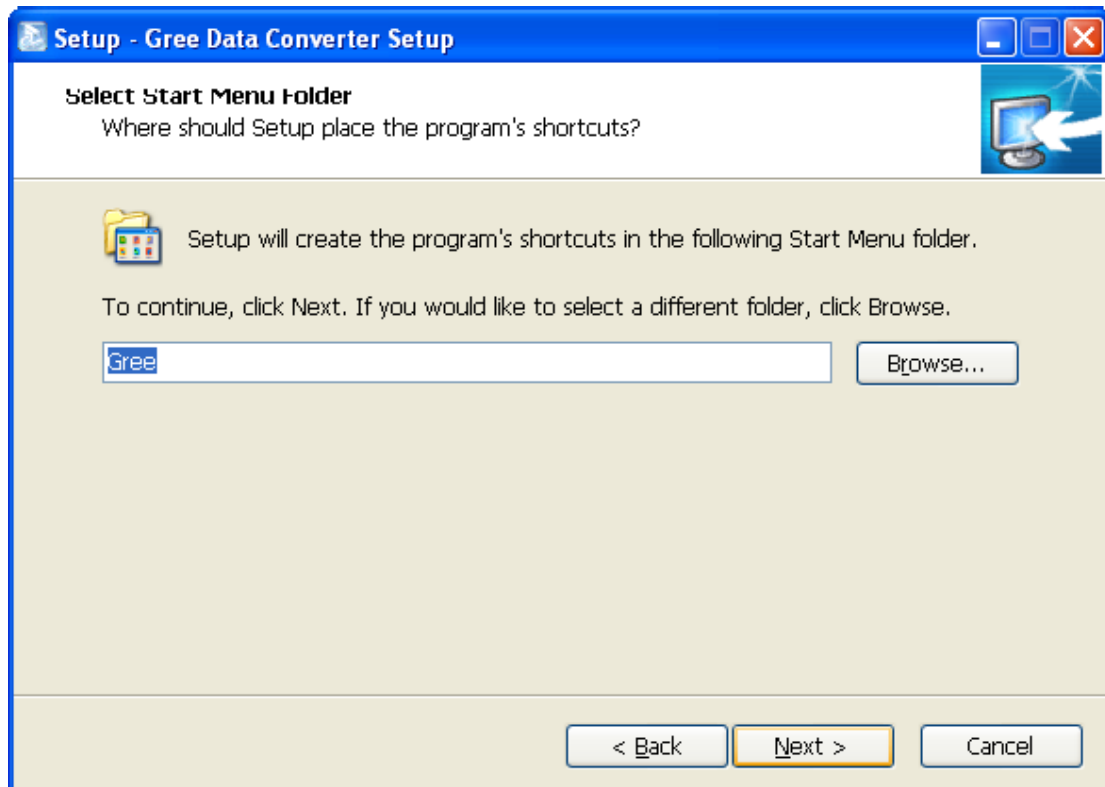

- If you want to create a desktop shortcut, tick "Create a desktop icon". Then click "Next" to continue.

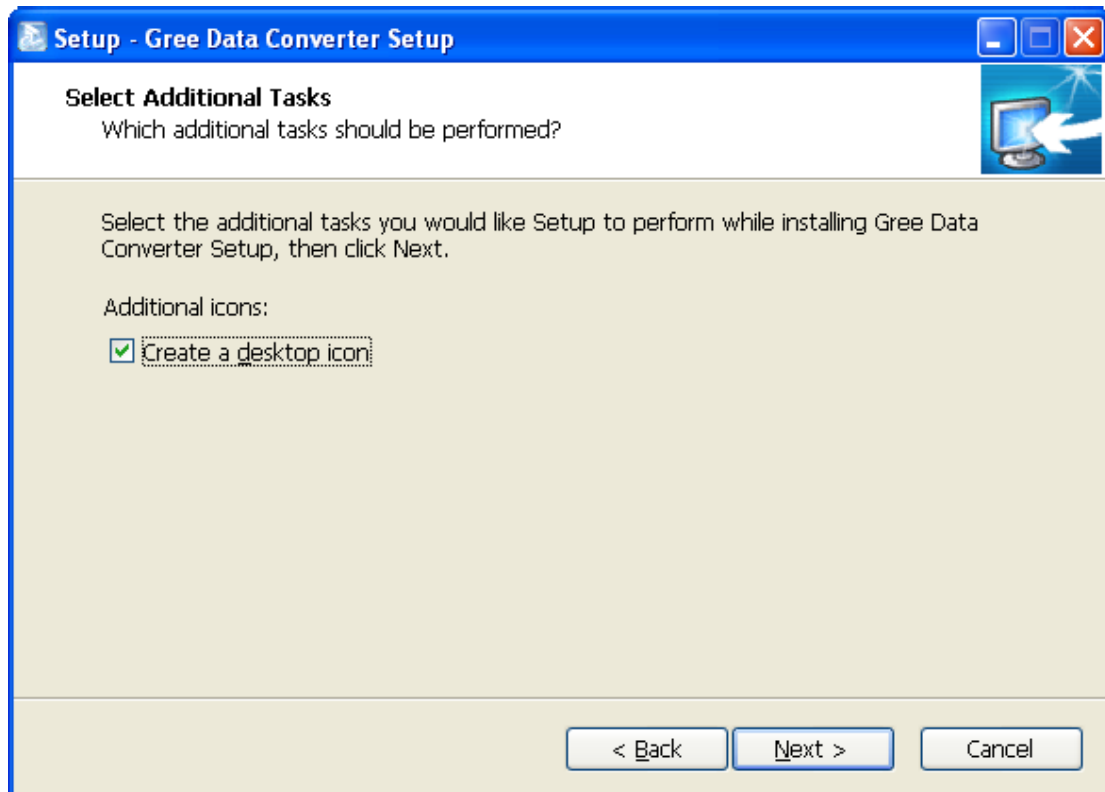

- Destination location, folder and additional task will be shown in the next step. If you need to change any of it, please click "**Back**". If not, click "**Install**" to start installation.

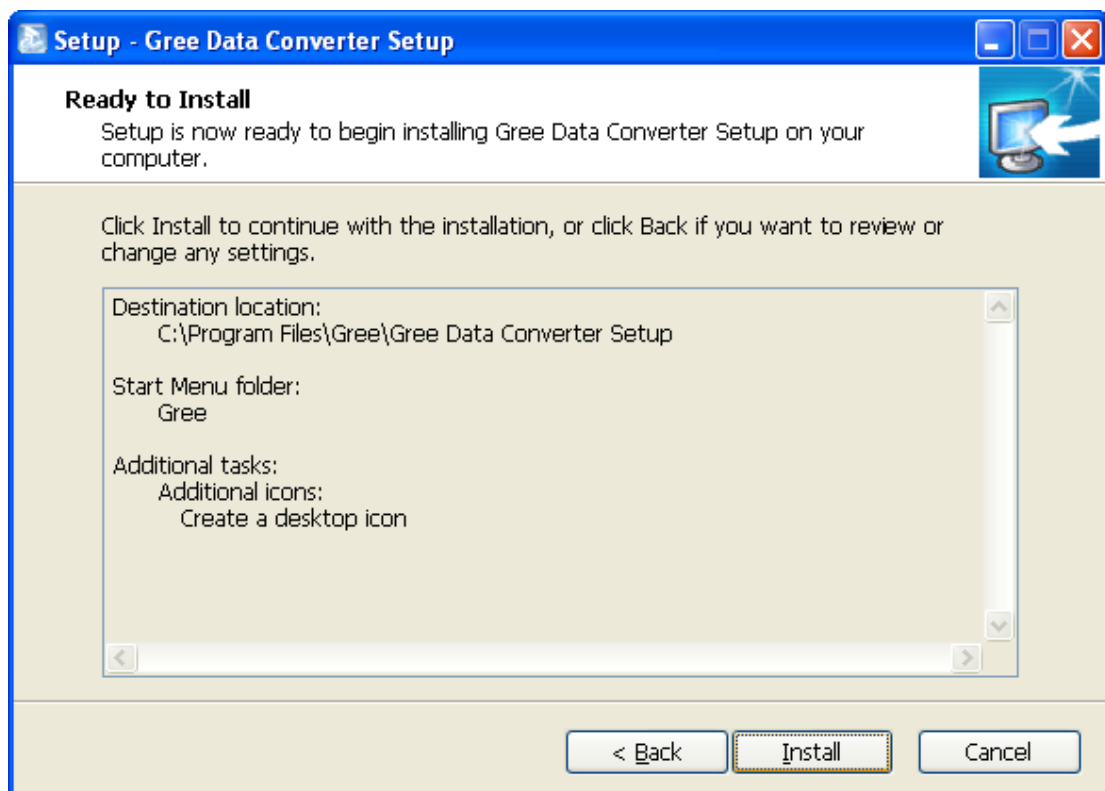

- Installation is in progress.

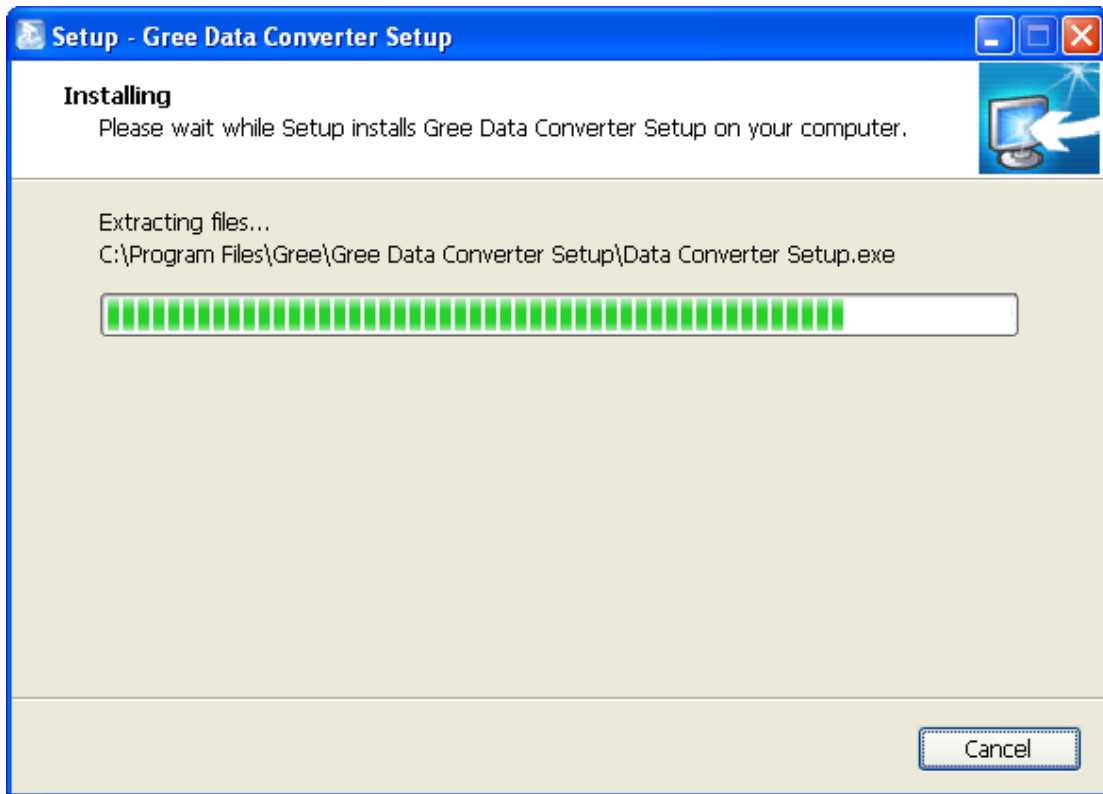

- Click "Finish" to complete the installation.

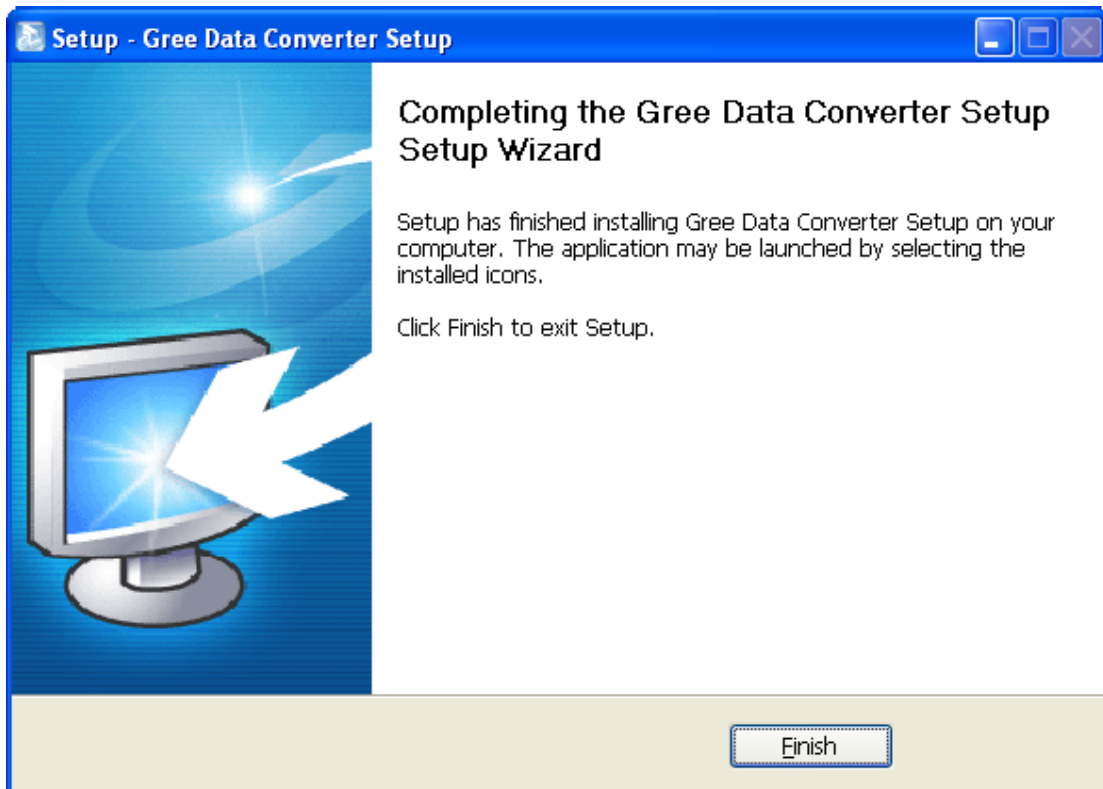

5. Use of Software

5.1 Introduction of Functions

5.1.1 One-button Commissioning

Personnel responsible for the commissioning of air conditioners can start commissioning by pressing one button according to the commissioning logic of software, which will give commissioning order to units. Then commissioning will start automatically step by step. During the commissioning, the corresponding process will be ticked in green on the software interface. If any commissioning process is not normal, it will be displayed in red.

5.1.2 Comprehensive Monitoring

The software can monitor every part of the air conditioning system, including functions, equipment and components operating status. The monitoring results will be displayed in text or curve so that user can acquire the operating status of the entire system conveniently and straightforwardly.

5.1.3 Real-time Control

Air conditioner's operating time and requirements may be different based on areas and functions. User can set units' parameters on computer according to actual needs, such as on/off, temperature, fan speed, mode, etc. Meanwhile, the software can also set or view the function parameters of outdoor units, gateway and other equipment. In this way, the management of central air conditioners is realized.

5.1.4 Applicable to Multiple Series, Models and Users

Gree Commissioning Tool Kits is applicable to air conditioning system that consists of multiple series and models. Later, it will be developed to cover all series of Gree central air conditioners, such as multi VRF, centrifugal chiller, screw chiller, ground source heat pump units, modular units, fan coiled units, close control units, etc. It can be used by system and controller designers to develop and monitor units, or used for maintenance and commissioning.

5.1.5 Other Functions

For the convenience of users, the software has added functions like connection guide, printing screen, opening database folder, rebuilding database, changing database saving path, etc.

5.2 Operation Methods

5.2.1 Data Monitoring

- Start up Gree Debugger.



- On the original interface, user can select language and units system. Click “OK” to confirm the defaulted language and units system and start up the software.

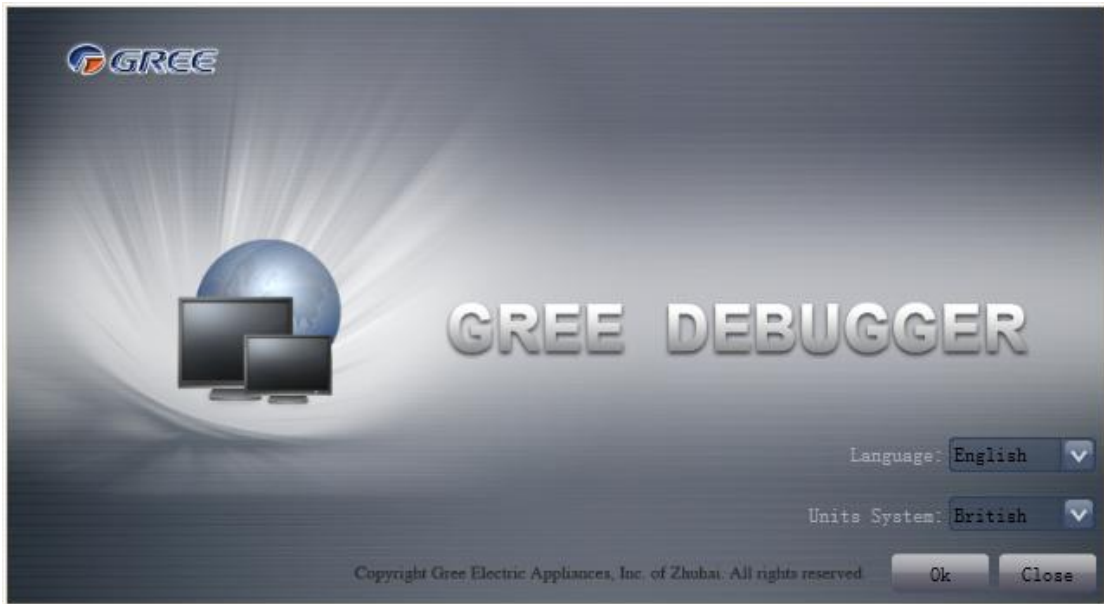

- Select language.

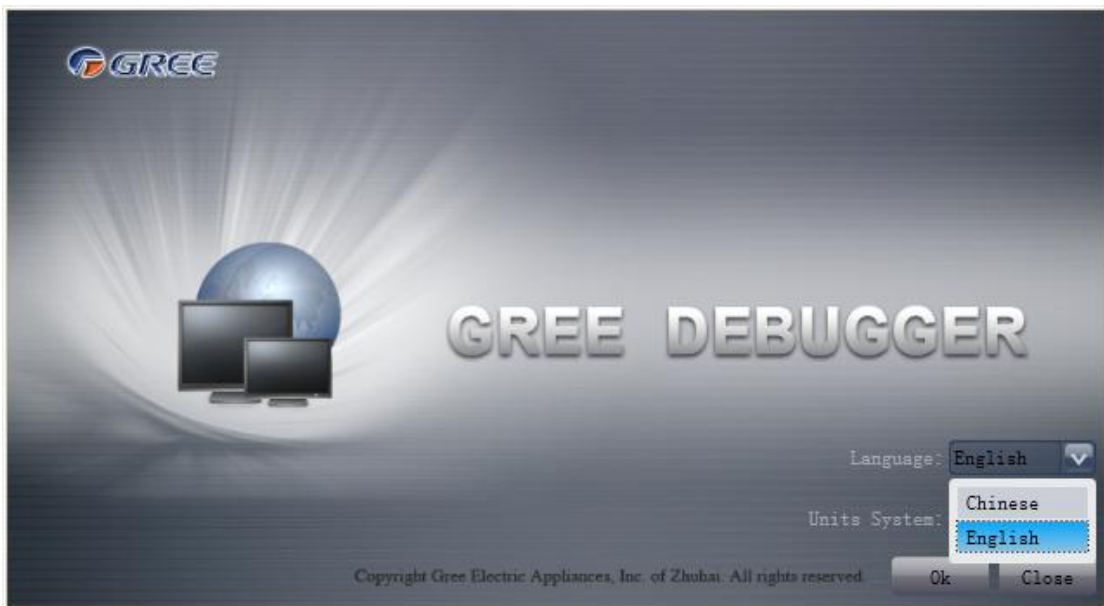

- Select system of units.

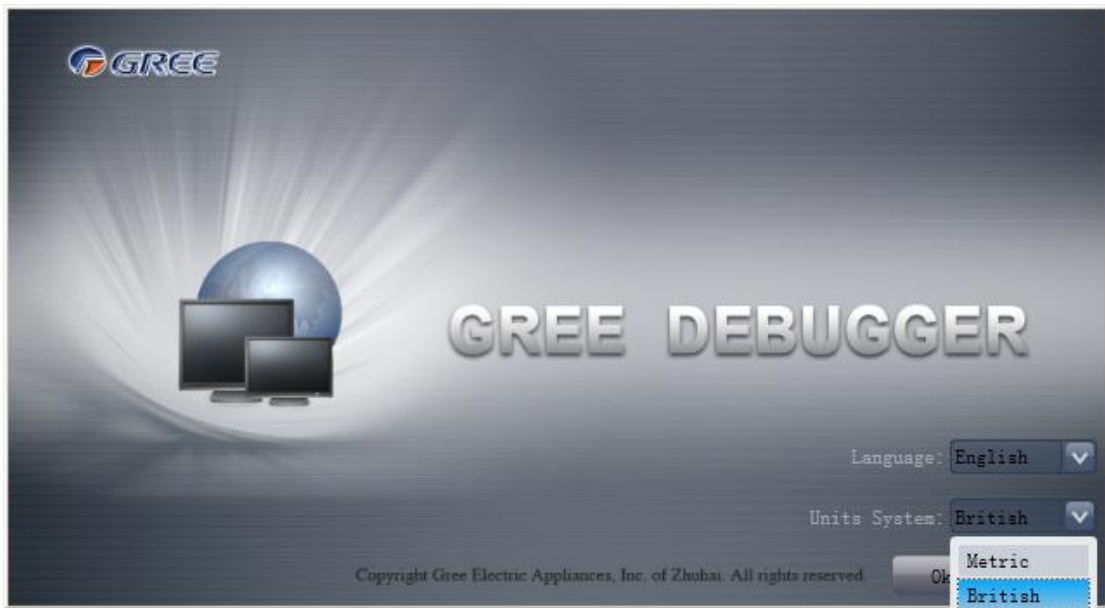

If units you want to monitor are already connected, and able to communicate normally, with correct COM and protocol, then you can click “Connect” to enter the interface of numbers. Otherwise, connect in accordance with the connection diagram shown below.

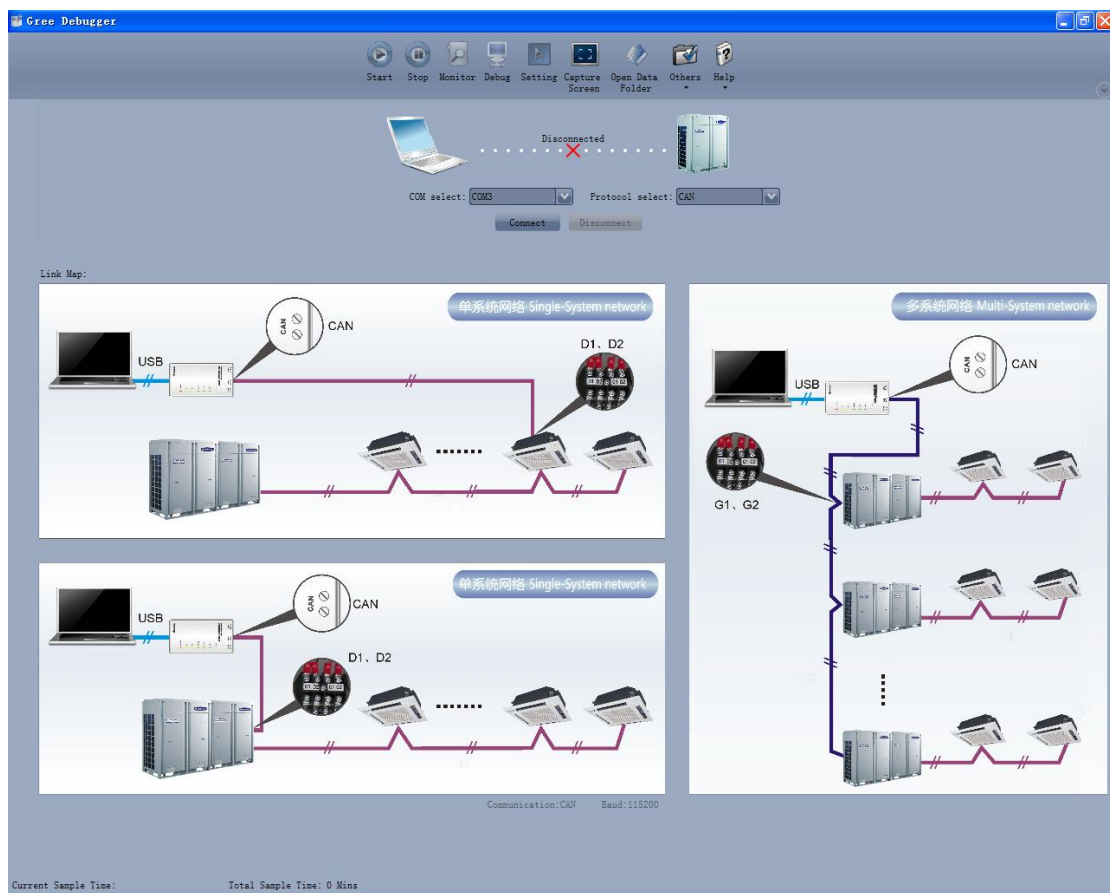

- COM selection: The serial port in your computer can be detected automatically. You just need to select your desired serial port.

GMV5 Home DC Inverter Multi VRF Units

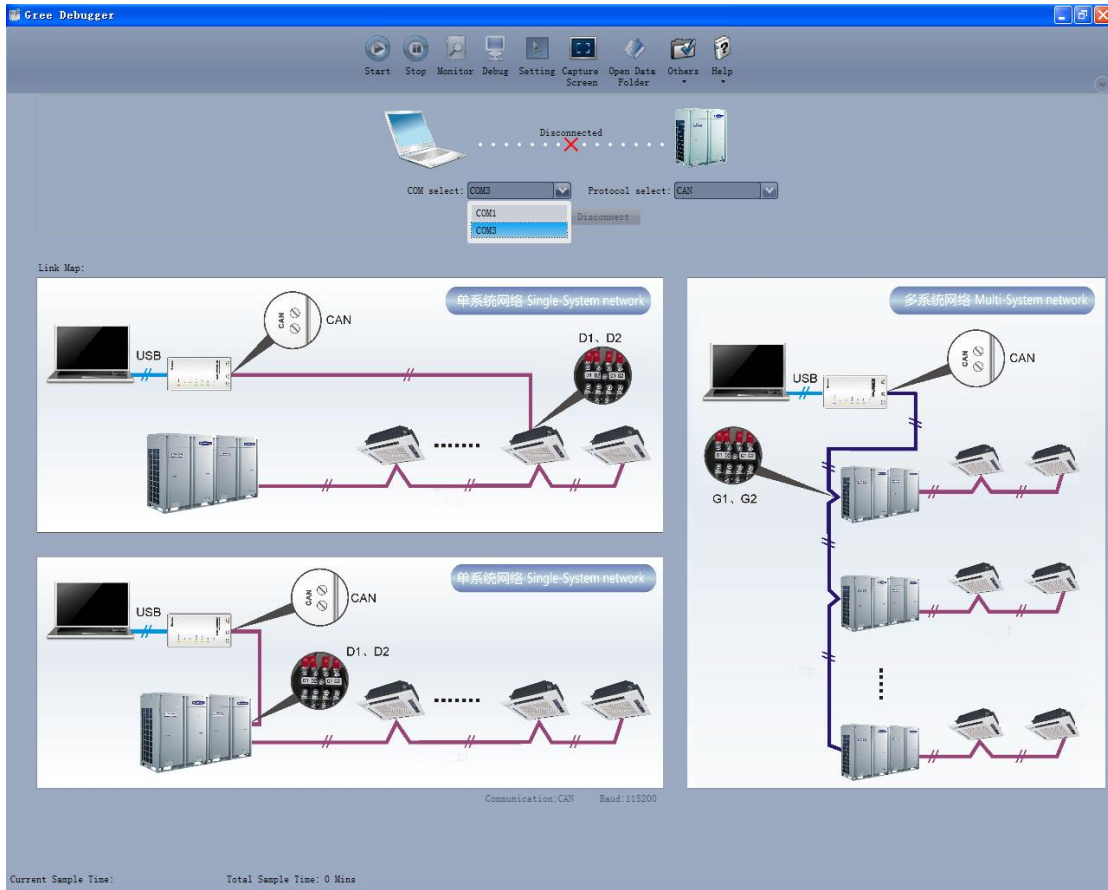

- Protocol selection: This is to select the communication method of your units. Currently, CAN is applicable to the units.

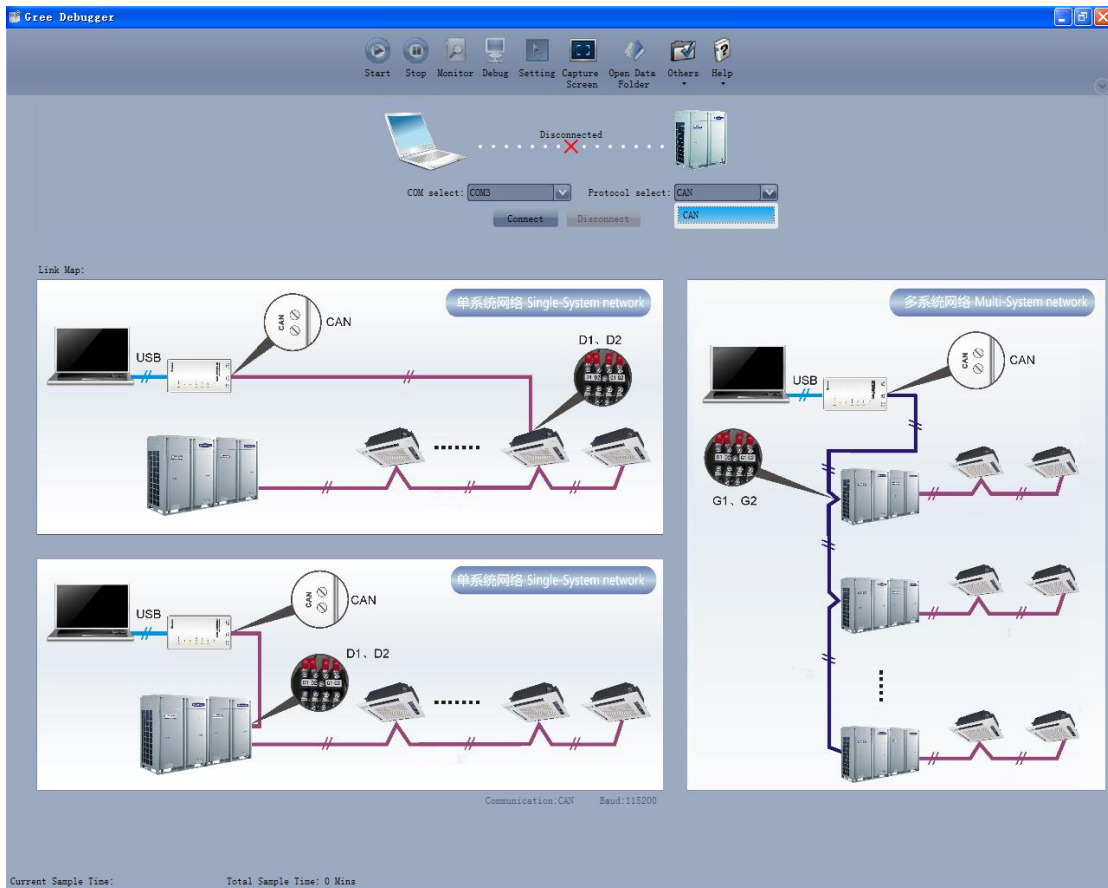

GMV5 Home DC Inverter Multi VRF Units

- After the selection, click “Connect”. If units can communicate normally with computer, then the interface of numbers will be shown soon. Otherwise, “Connecting” will be shown.

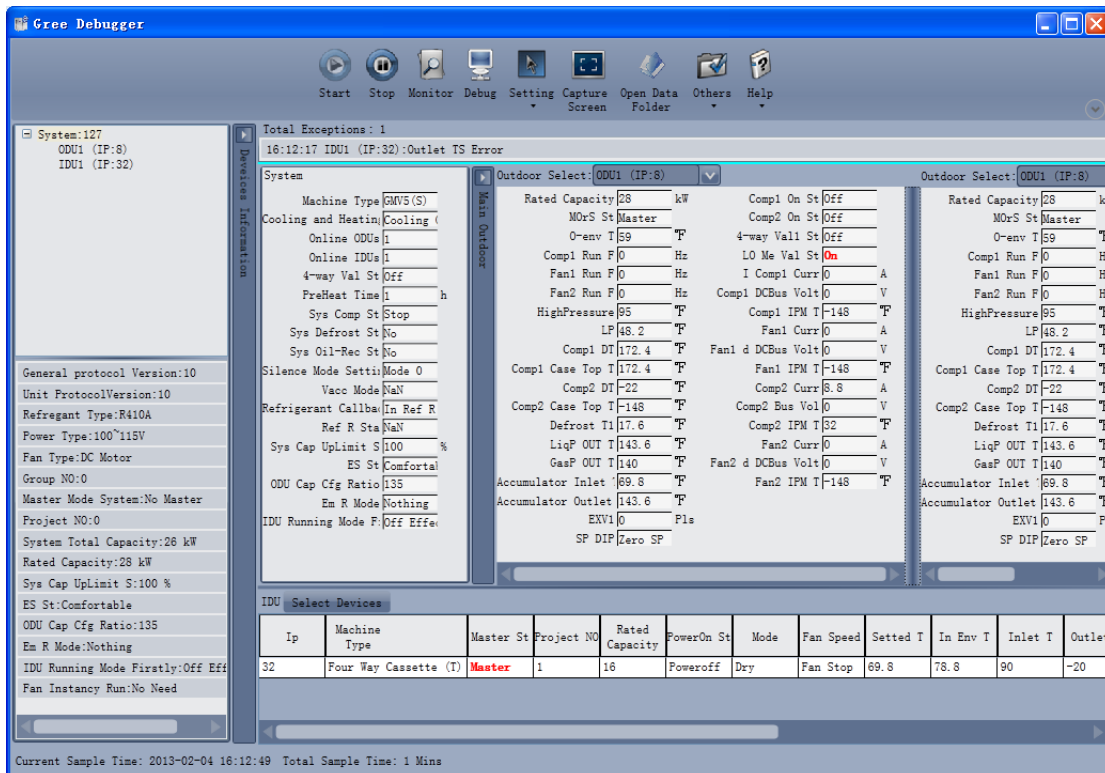
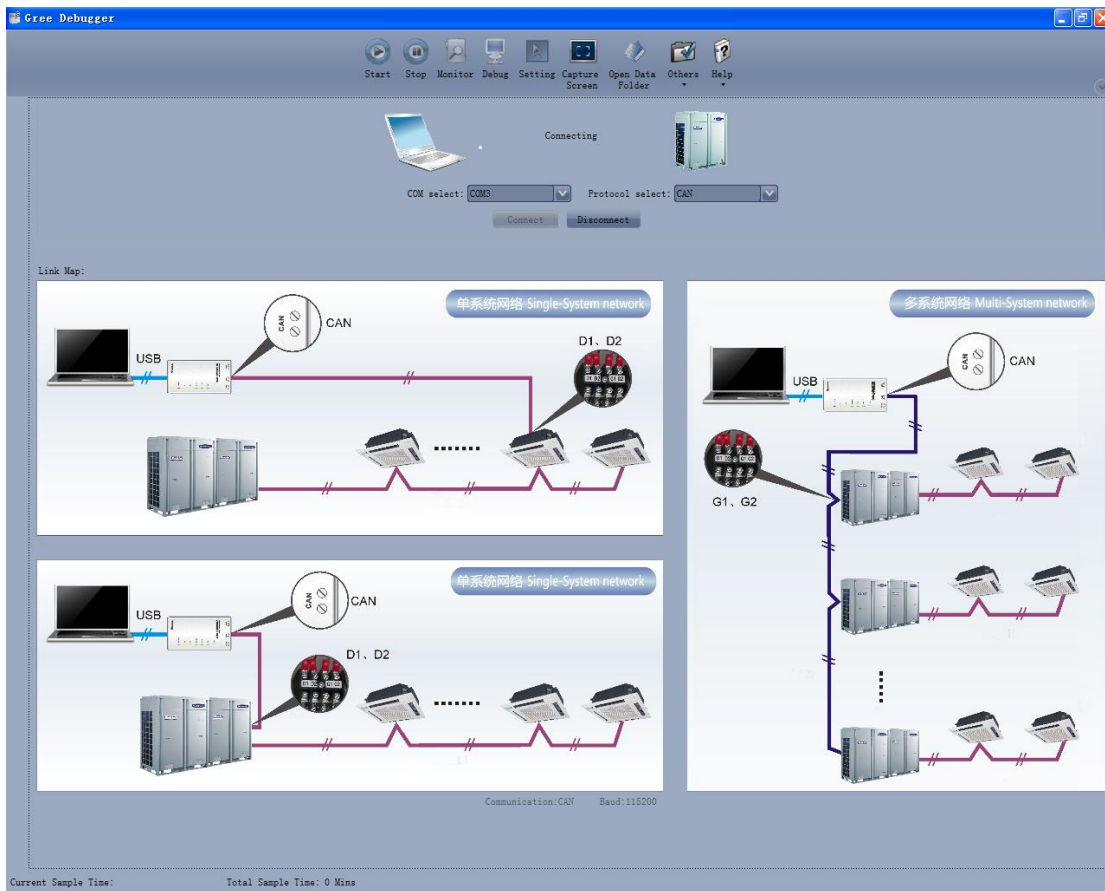

- There are several display zones on this interface. You can hide devices information and system information by clicking devices information icon and system icon . Display zones of indoor unit information and errors can be dragged up and down at the dividing lines. As to the

GMV5 Home DC Inverter Multi VRF Units

display zone of outdoor modules information, it can show information of only one module and hide information of others (two modules are defaulted to be shown). Menu bar can be hidden by

clicking icon . Status bar shows the current time and period for data collection.

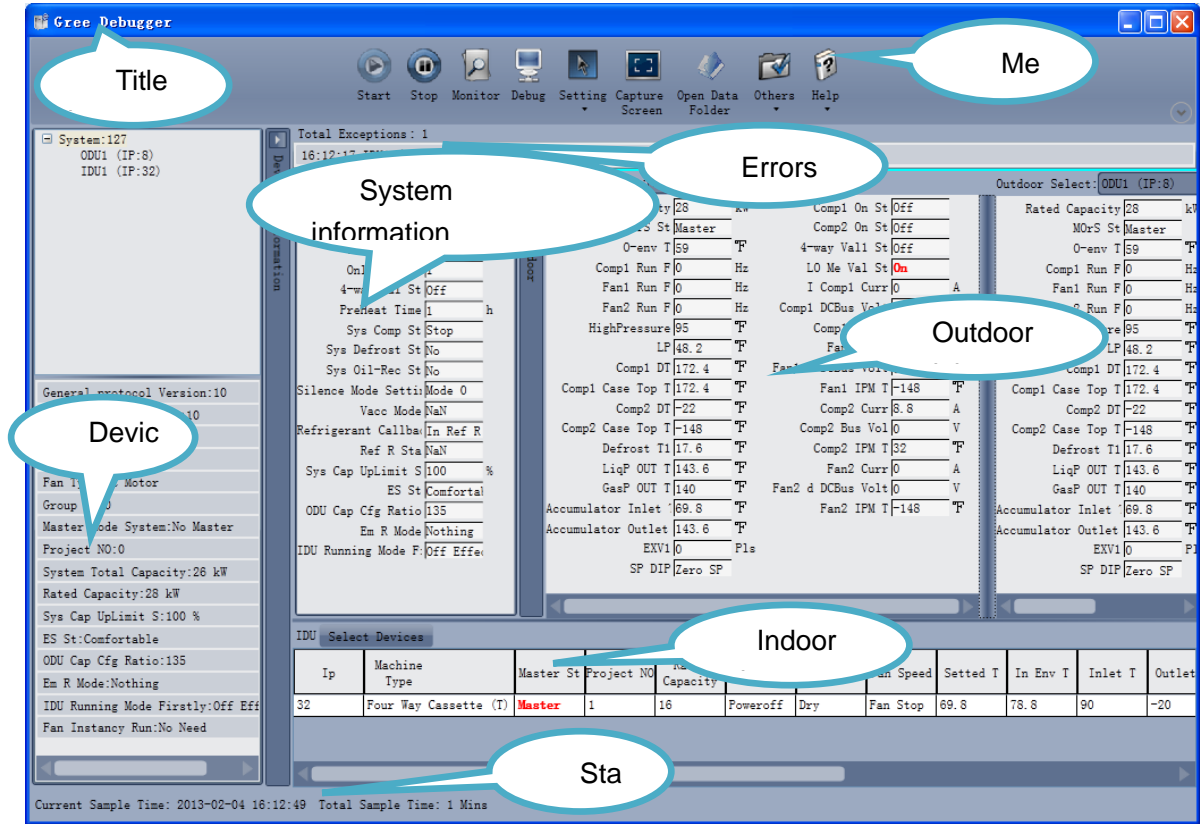

- On the display zone of devices information, you can click to select and view units that need monitoring.

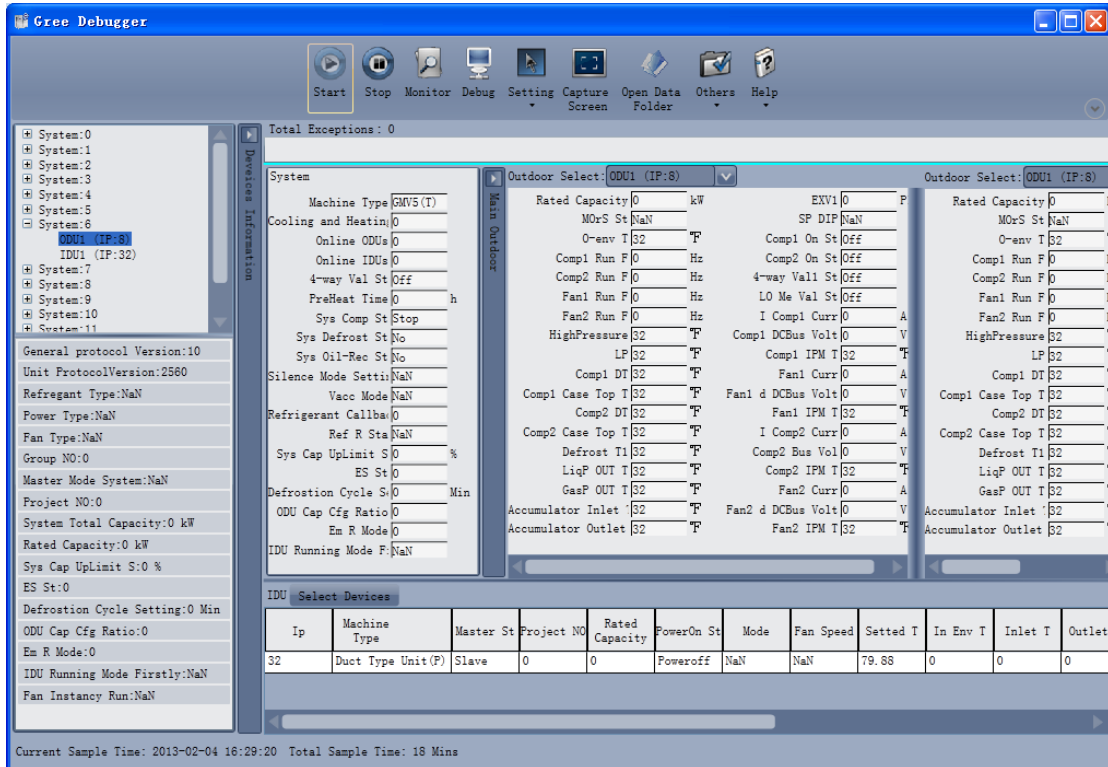

5.2.2 Project Debugging

- Click icon of “Debug” on the menu bar and the interface will be switched to project debugging, where auto debugging will start from up to down and from left to right. Note: Debugging function is only applicable to a single-system network.

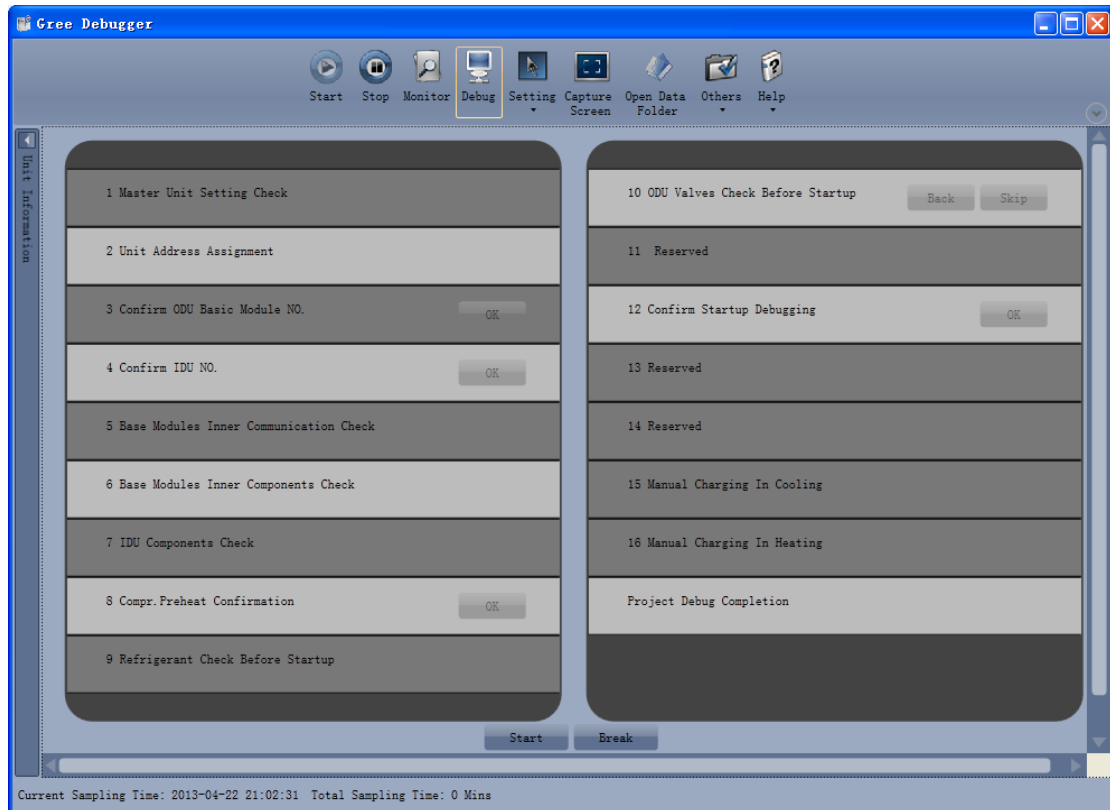

- Click “Start” to enable the debugging function. Then debugging will start automatically. 

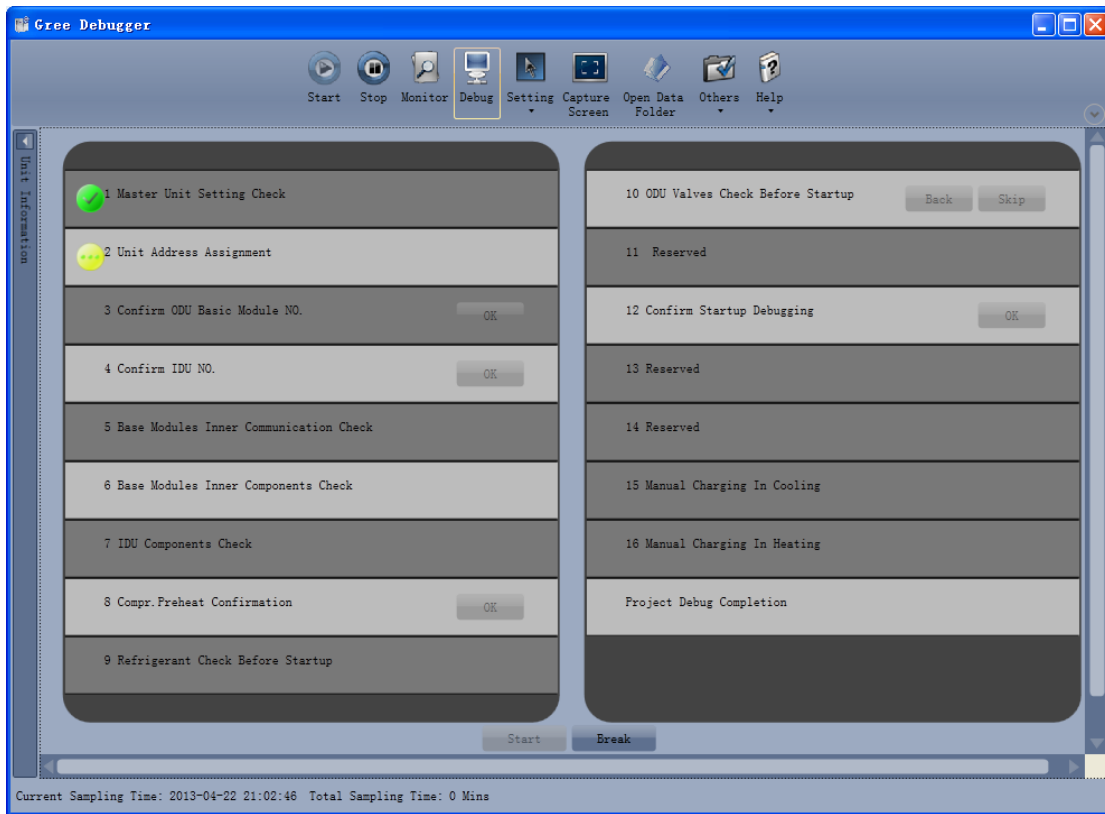

indicates that debugging is in progress while  indicates debugging is completed.

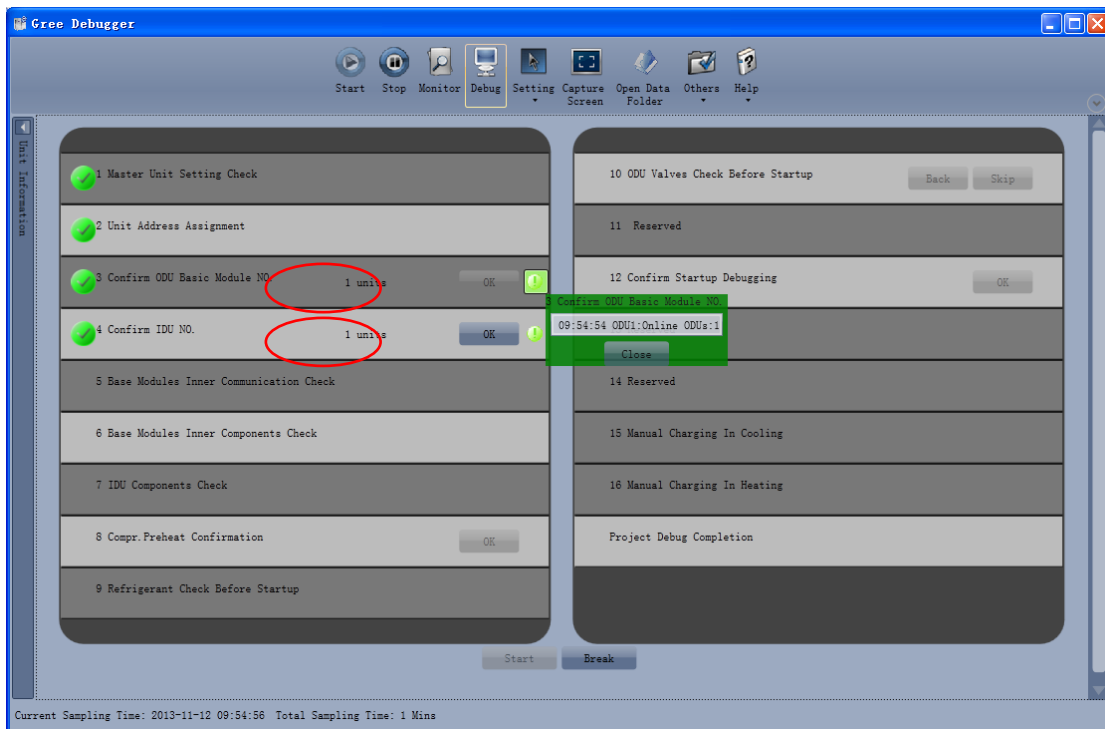

- If “OK” button is displayed, it means user needs to judge whether to continue debugging or not. Click icon  and relevant information will be shown for your reference. Click “Close” to close the pop-up (For No.3 Confirm ODU Basic Module NO. and No.4 Confirm IDU NO., the current number of units under debugging will be displayed. See the following marked with circle. For No.8 Compr. Preheat Confirmation, the preheat time will be displayed. See the following marked with circle).

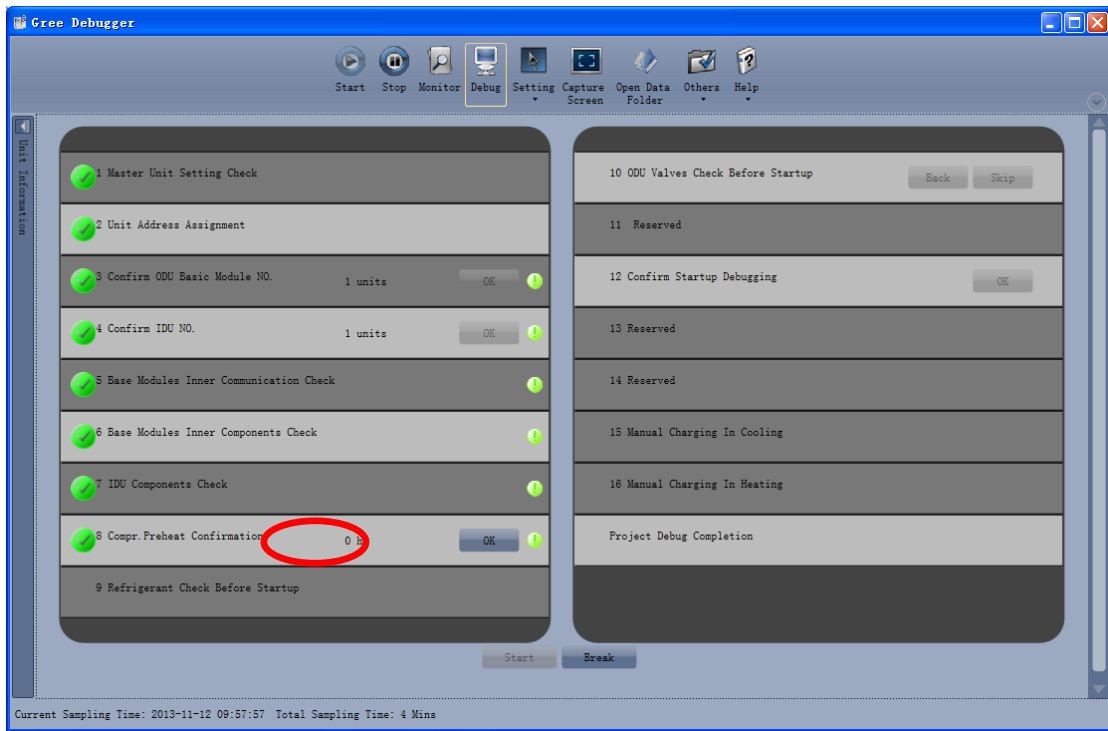



- Icon  indicates that there is problem found during debugging. Debugging will not be completed unless problem is solved (after problem is solved, step without “OK” button will switch to the next step automatically, otherwise user needs to click “OK” to continue). Click icon  and relevant information detected in this step will be displayed for your reference in order to solve problems. Click “Close” to close the pop-up.

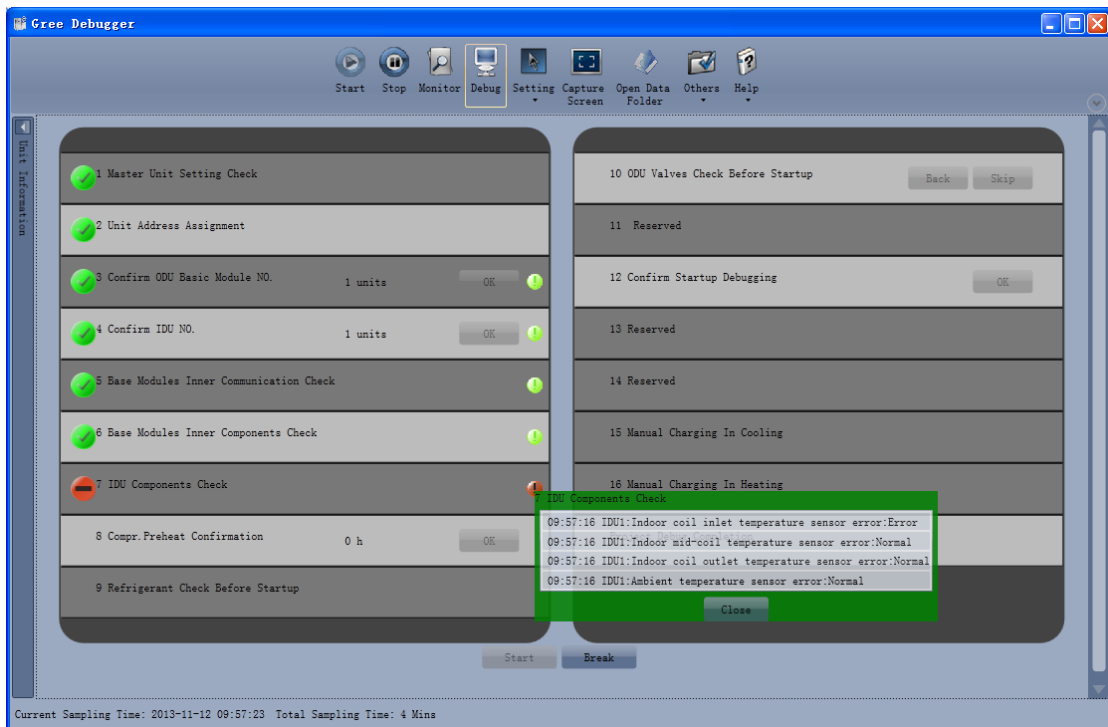

- During debugging, a click on “Break” can stop debugging. Click “Start” to resume debugging and then debugging will be finished step by step. For No.10 ODU Valves Check Before Startup, there are “Back” and “Skip” buttons. If there is error in this step, you can go back to step No.9 and

click “OK” to restart debugging on step No.10. If the error in step No.10 is U6 error (Warning against valve error), you can click “Skip”. In other cases, “Skip” button is null.

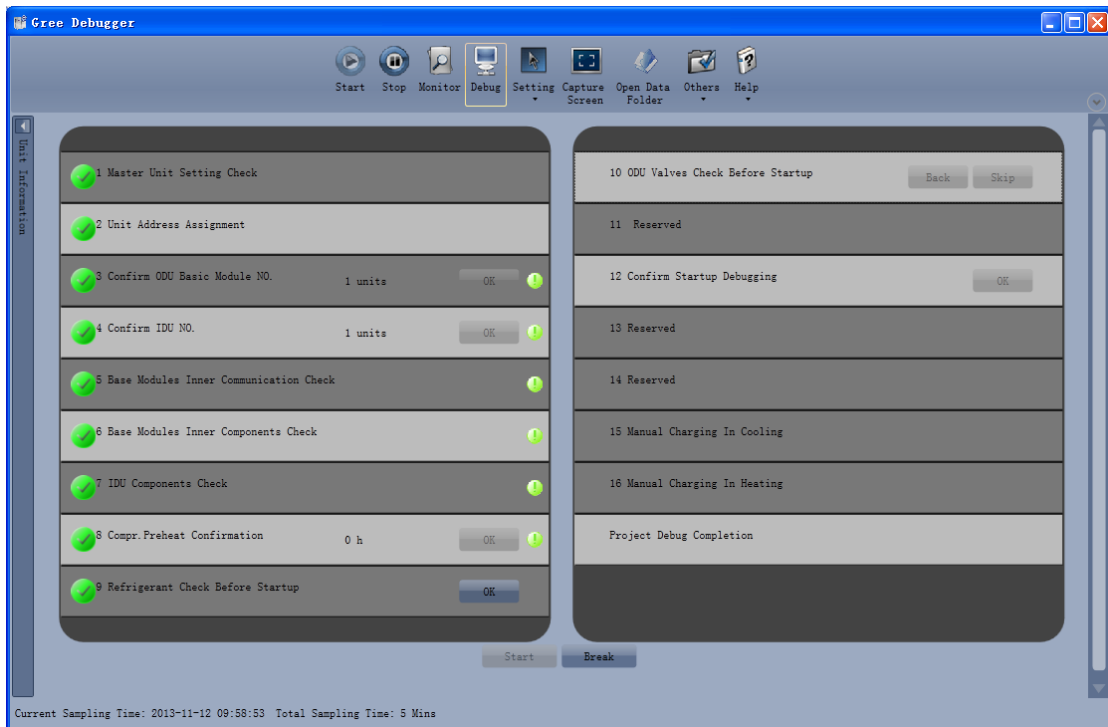
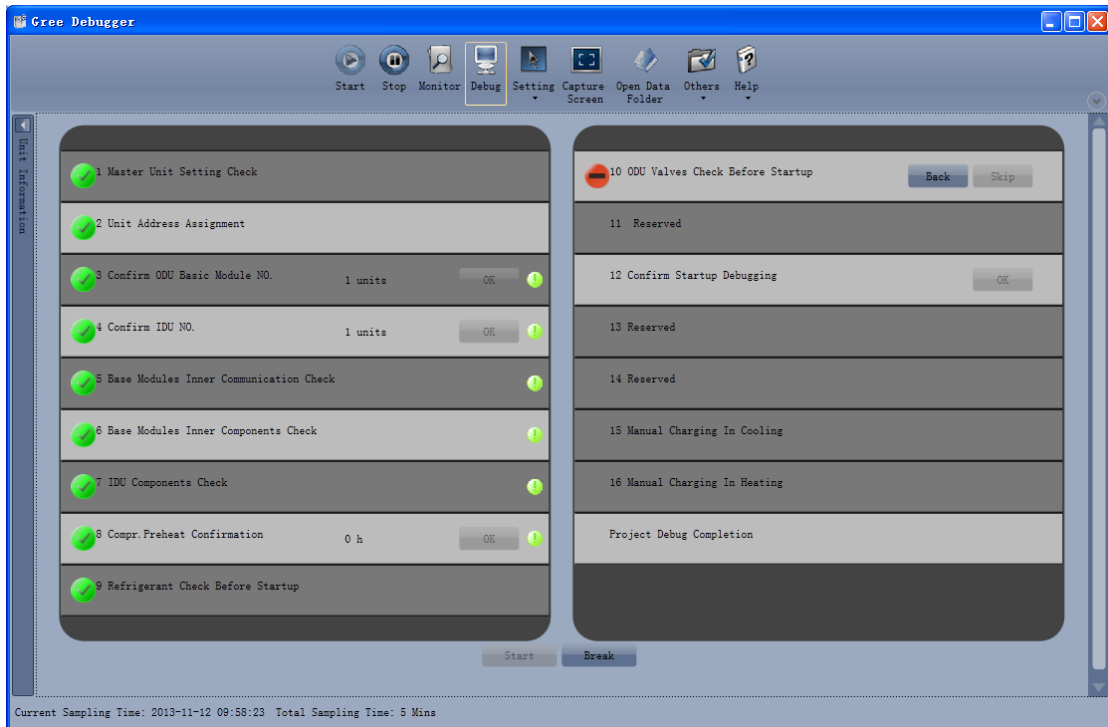

- Step 11, 13 and 14 are reserved steps. And step 13, 14, 15 and 16 are steps in parallel (only one of the four will be selected according to actual needs). In the end, when the step “Project Debug Completion” shows green, debugging is completed.

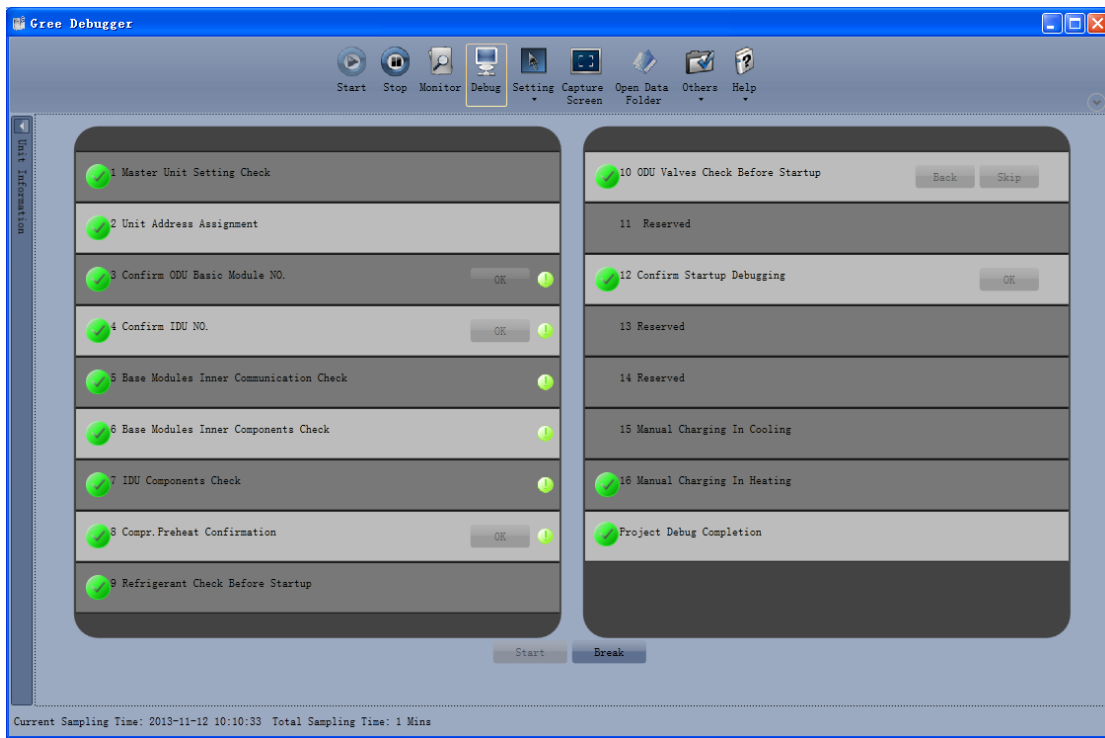

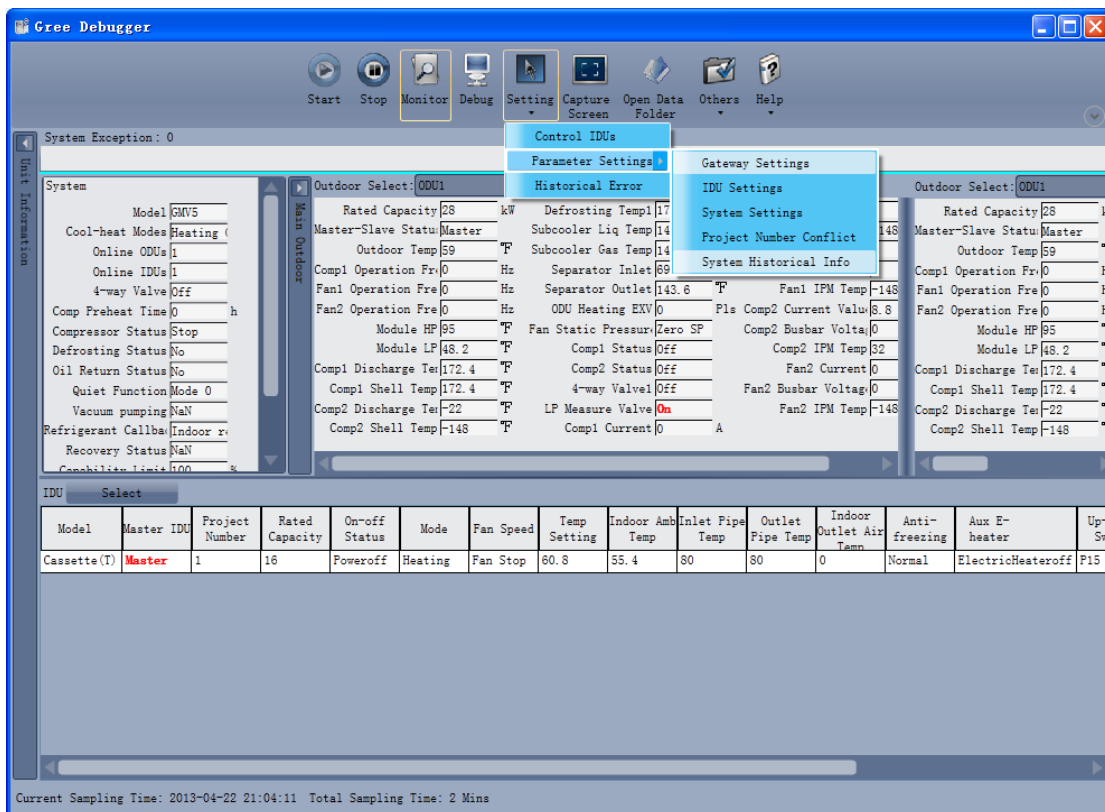

5.2.3 Control Units

- Click icon of “Setting” on menu bar and select parameter settings, which include “Gateway Settings”, “IDU Settings”, “System Settings”, “Project Number Conflict (In case there is project number conflict in indoor units, other functions will be shielded. Then this parameter needs to be set in order to eliminate the conflict)” and “System Historical Info”. Click the corresponding module and adjust the parameters.

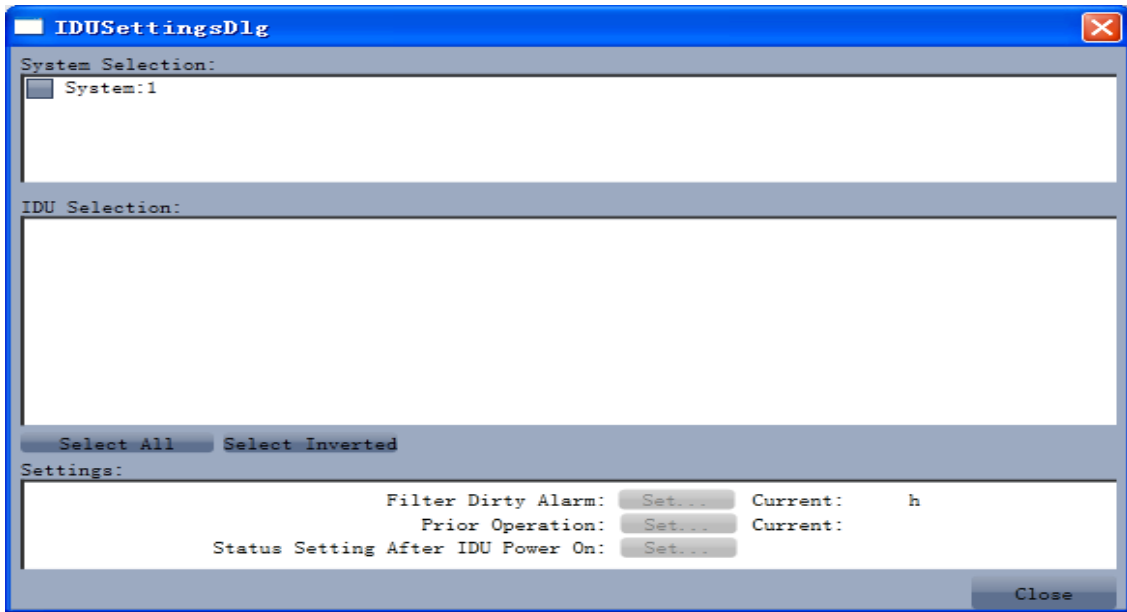

- Take indoor unit as an example. Click “IDU Settings” and a dialog box will pop up.



- Tick the indoor units that need setting in the IDU selection zone or you may click “Select All” to select all of them or “Select Inverted” to select none of them. After selection, the current values of the corresponding parameters will be displayed in the zone of settings. Click “Set” and then click  in the pop-up dialog box to select values. Click “Set” and then the corresponding order will be sent to units. If setting is successful, it will be displayed at the current values.

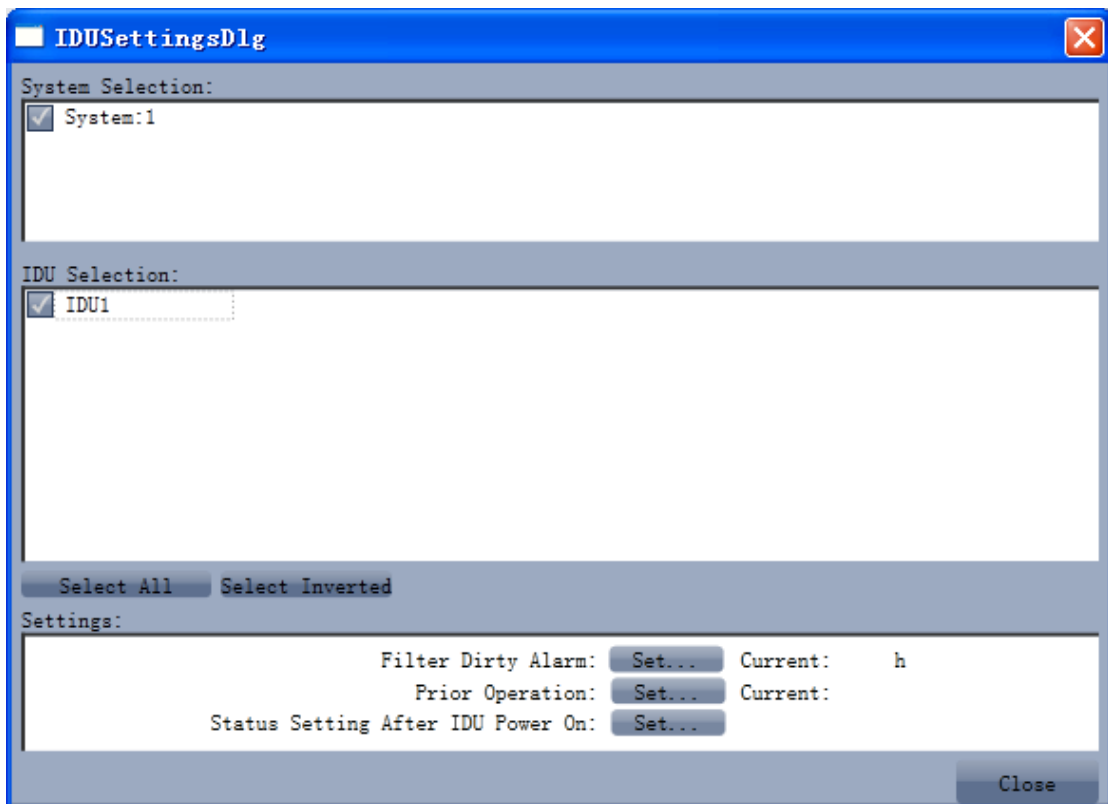

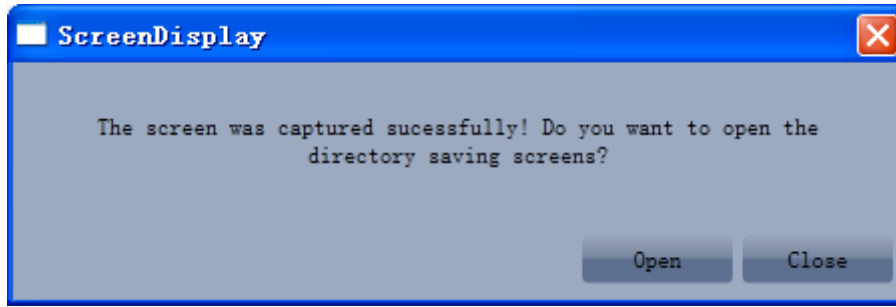

5.2.4 Other Functions

Capture Screen

- Click icon of “Capture Screen” to print the interface. If you want to open the interface, click “Open”.

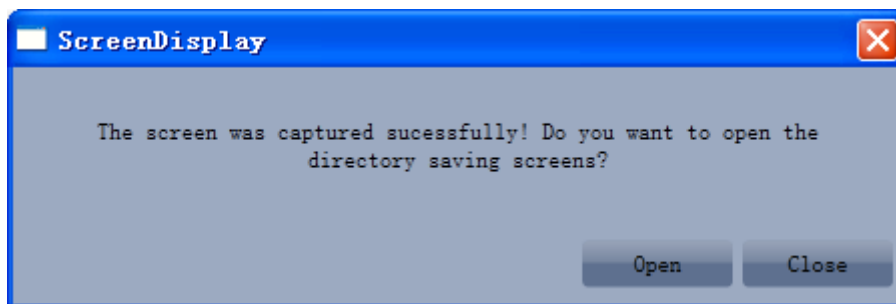
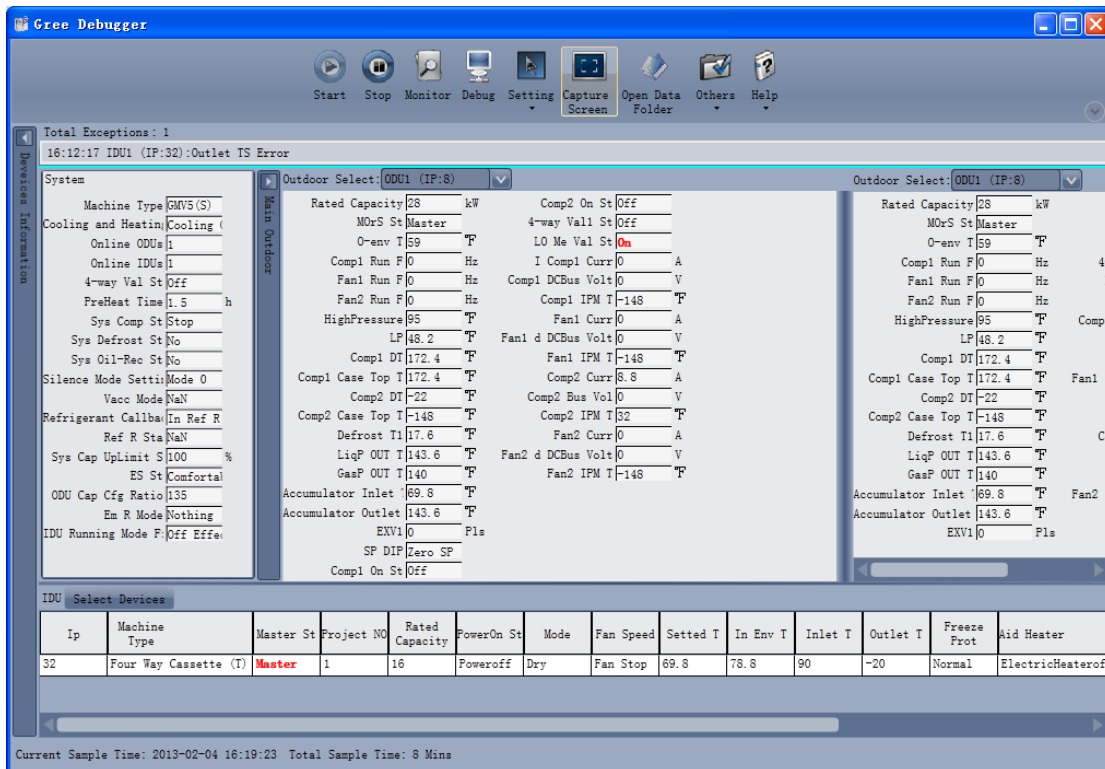

Search for Database Folder

- Click icon of “Open Data Folder” on the menu bar to open database folder.

GMV5 Home DC Inverter Multi VRF Units

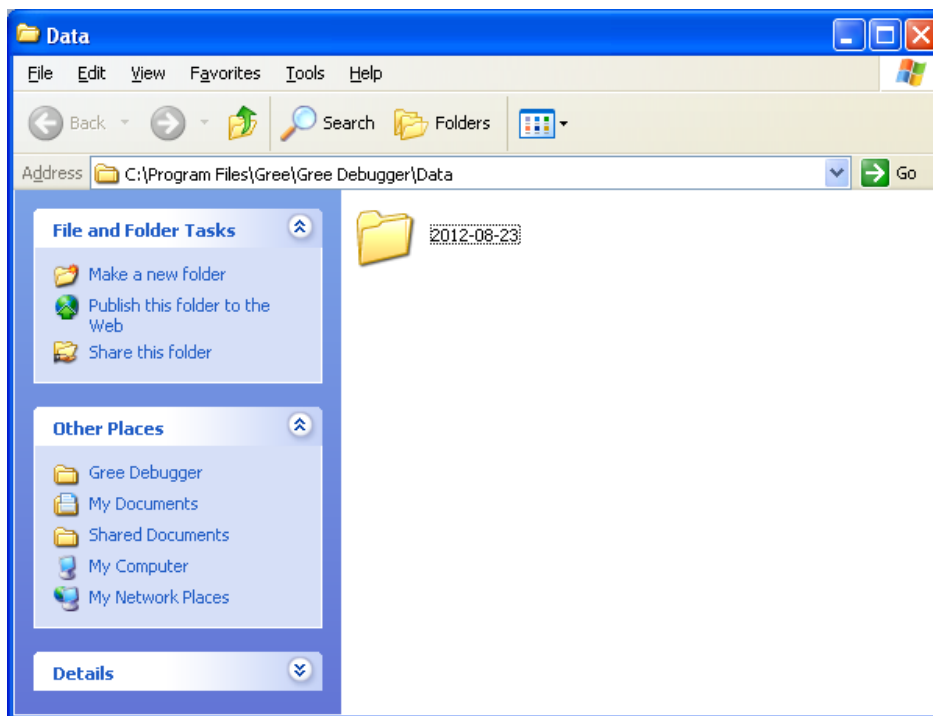
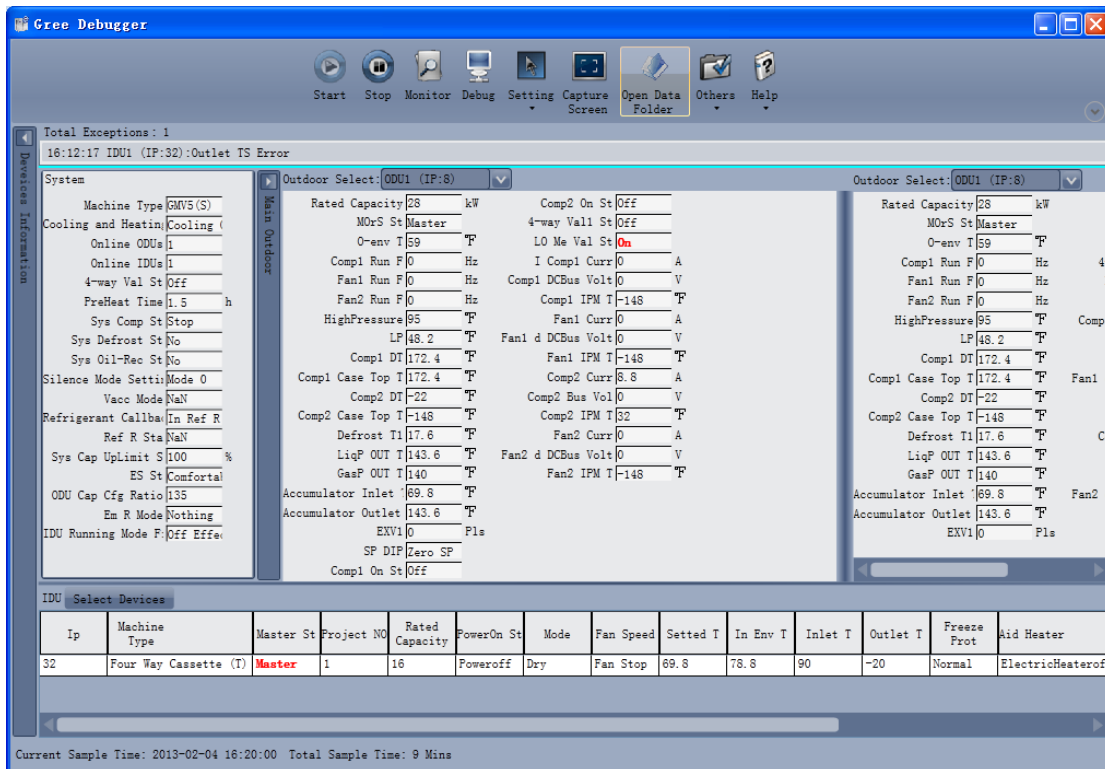

Conversion of Pressure Value

- Click icon of “Others” on the menu bar and then click “Display Settings” to select “High Low Pressure Value” and “Refrigerant Type”. Select “Temperature” and the pressure parameter displayed on the interface will be temperature. Select “Pressure” and the pressure parameter displayed on the pressure interface will be pressure. Refrigerant type will affect the pressure parameter displayed on the interface.

GMV5 Home DC Inverter Multi VRF Units

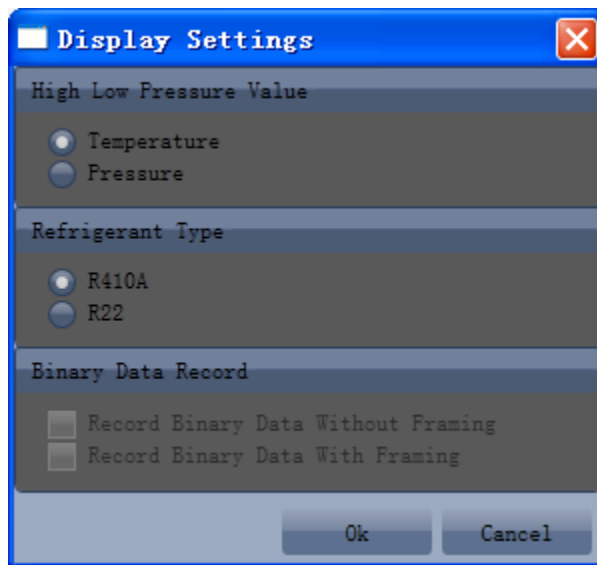
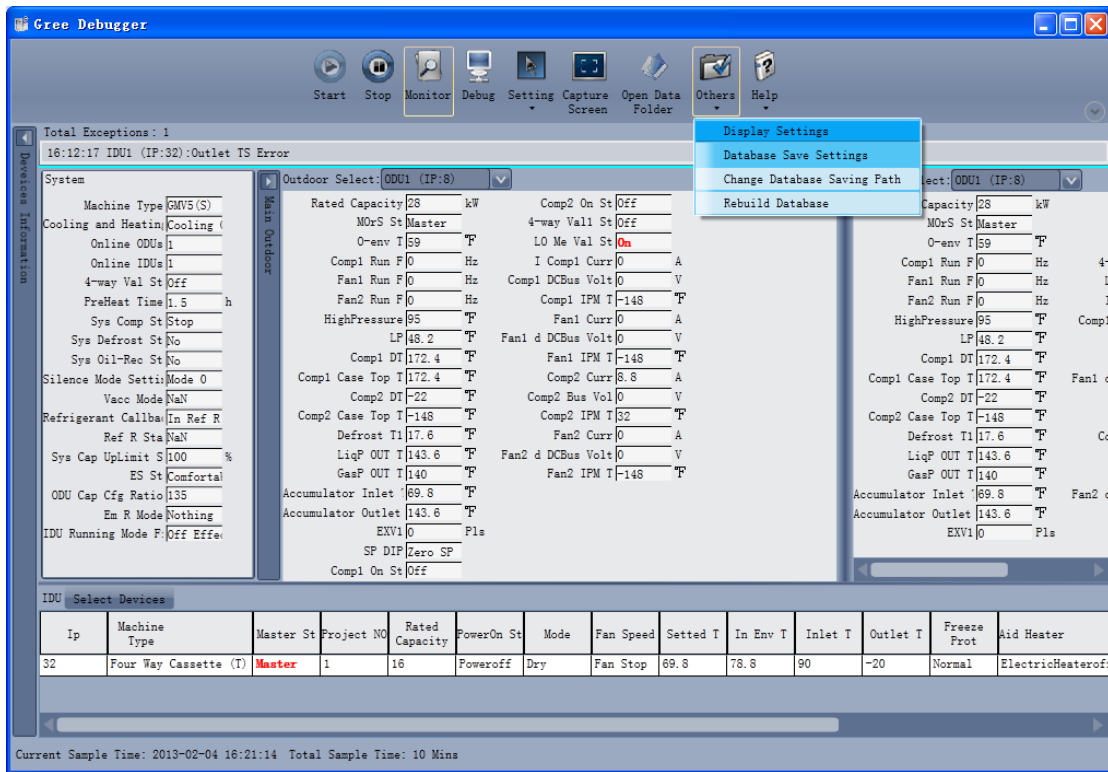

Database Saving of Multiple Systems

- Click icon of "Others" on the menu bar and click "Database Save Settings" to select which system that needs to save database. Because there is a large quantity of data in a network that contains multiple systems, data of only one system can be saved.

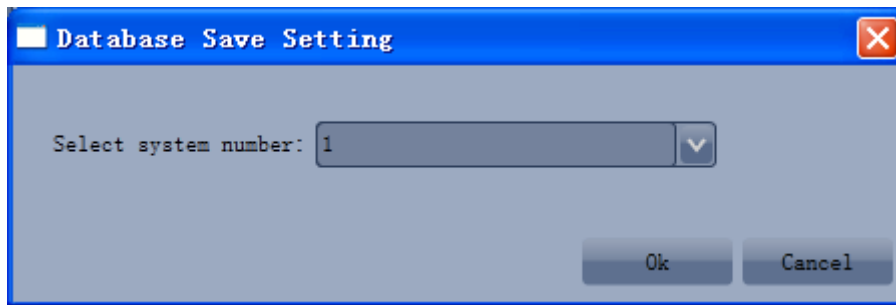
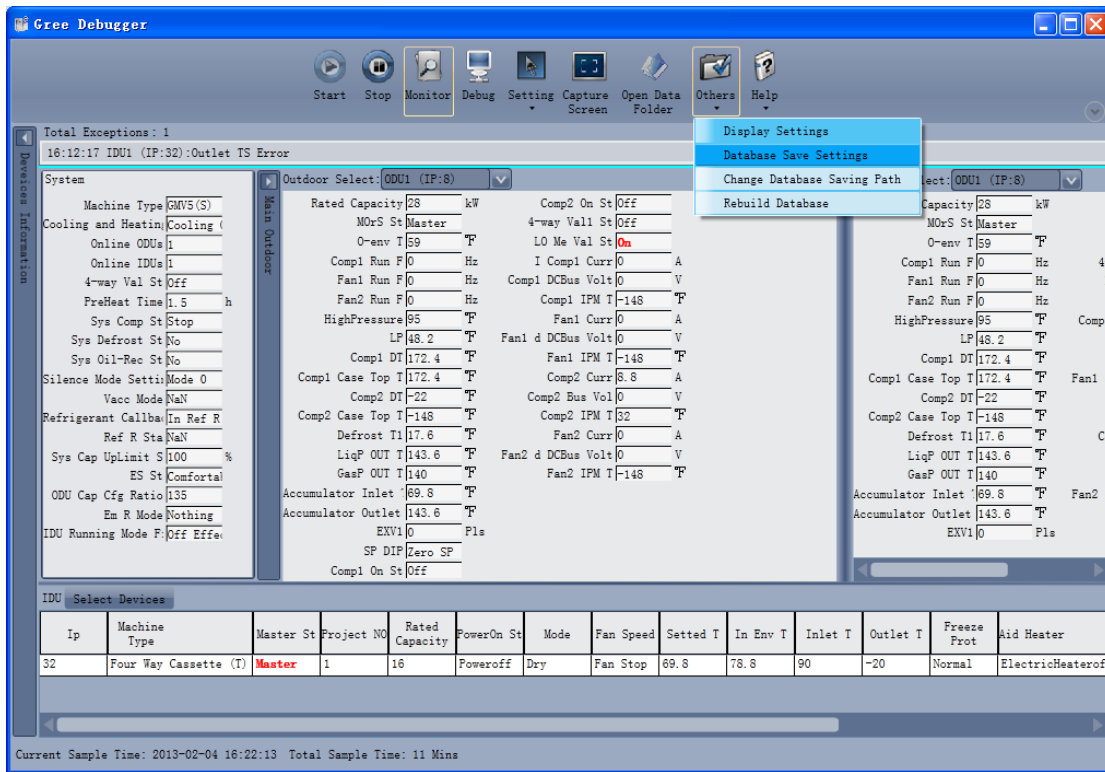

Change Database Saving Path and Rebuild Database

- Change of database saving path and rebuilding of database should be set before the software starts monitoring (see below interface). Click “Change database saving path” and click “Browse” to change the saving path. Click “Rebuild Database” to rebuild the database folder. You can also stop monitoring and turn back to the connection interface to change saving path or rebuild database during monitoring.

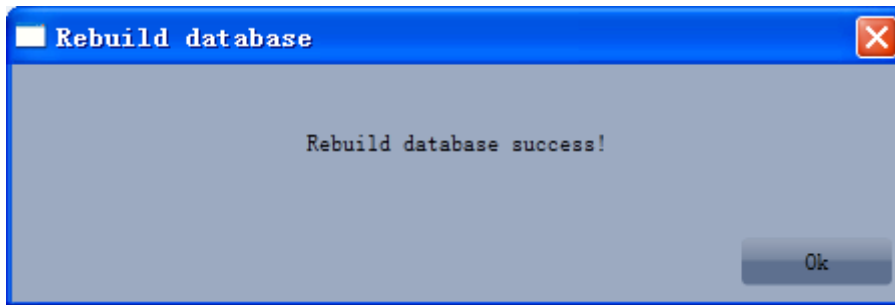
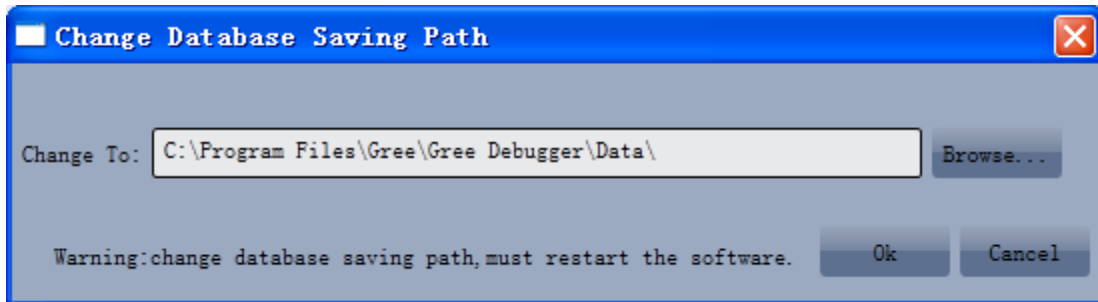
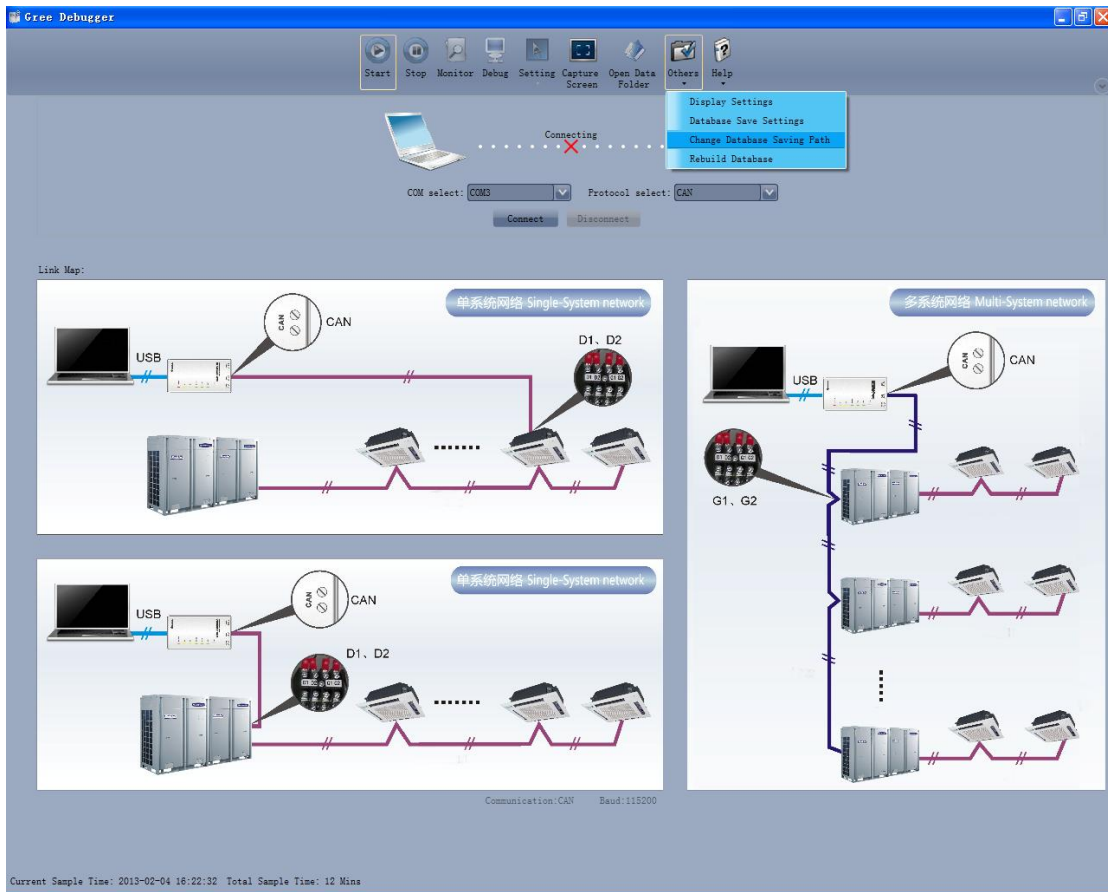

5.2.5 Use of USB Converter

Usage of converter:

- Gree commissioning software should be connected with CAN interface when converter is used. For air conditioners with a single system, connect D1 and D2 interfaces of the wiring board. For air conditioners with multiple systems, connect G1 and G2 interfaces of the wiring board.

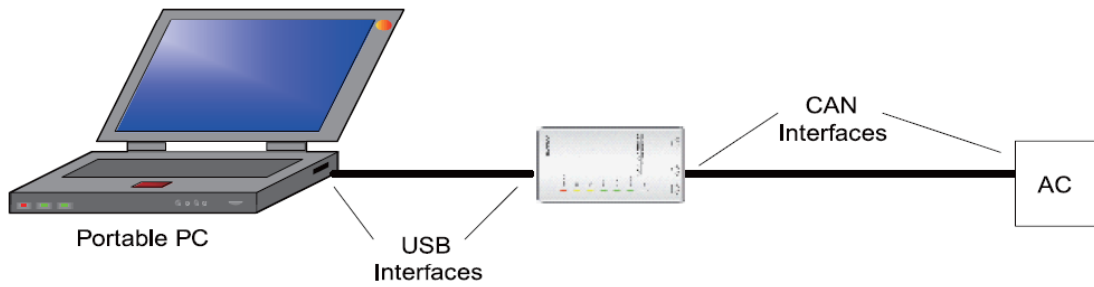

- Gree monitoring software should be connected with RS485 interface when converter is used. Connect outdoor or indoor units or the main board of wired controller according to actual needs.

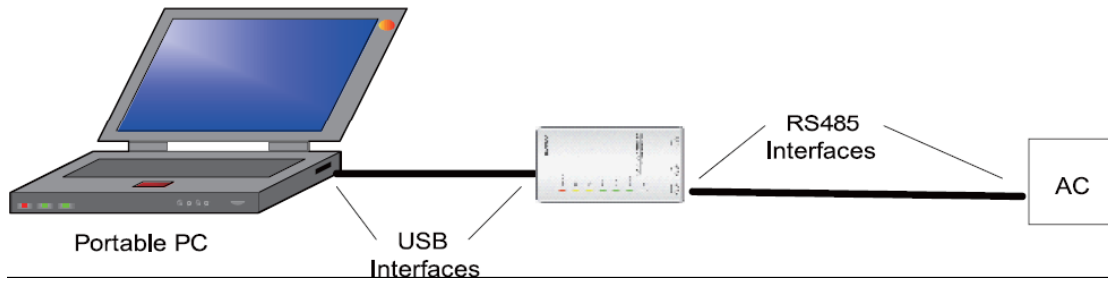

- HBS, CAN and RS485 of the converter can be switched by buttons. Press the button “SET” on the converter to realize conversion among HBS, CAN and RS485 interfaces. You can check the setting through function LEDs.

Notice: If it's the first time your PC uses Gree USB data converter, in order to prevent Gree USB data converter from being mistaken by your computer as other devices and make sure your mouse can work well, it is necessary to turn off the Serial Enumerator of computer after Gree USB data converter is connected. Below are the steps:

Step 1: Right click "My Computer" on the desktop and click "Manage".

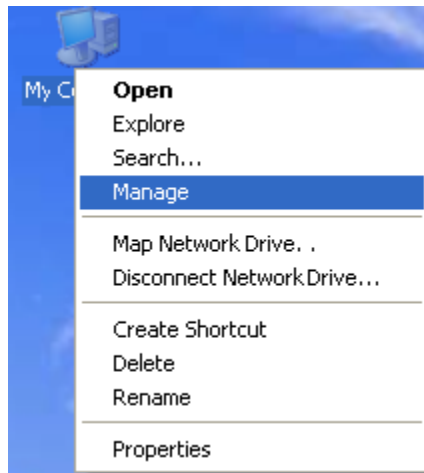

Step 2: In the pop-up window, select “Device Manager” in the left column and then find “Port (COM and LPT)” in the right column. Click its +.

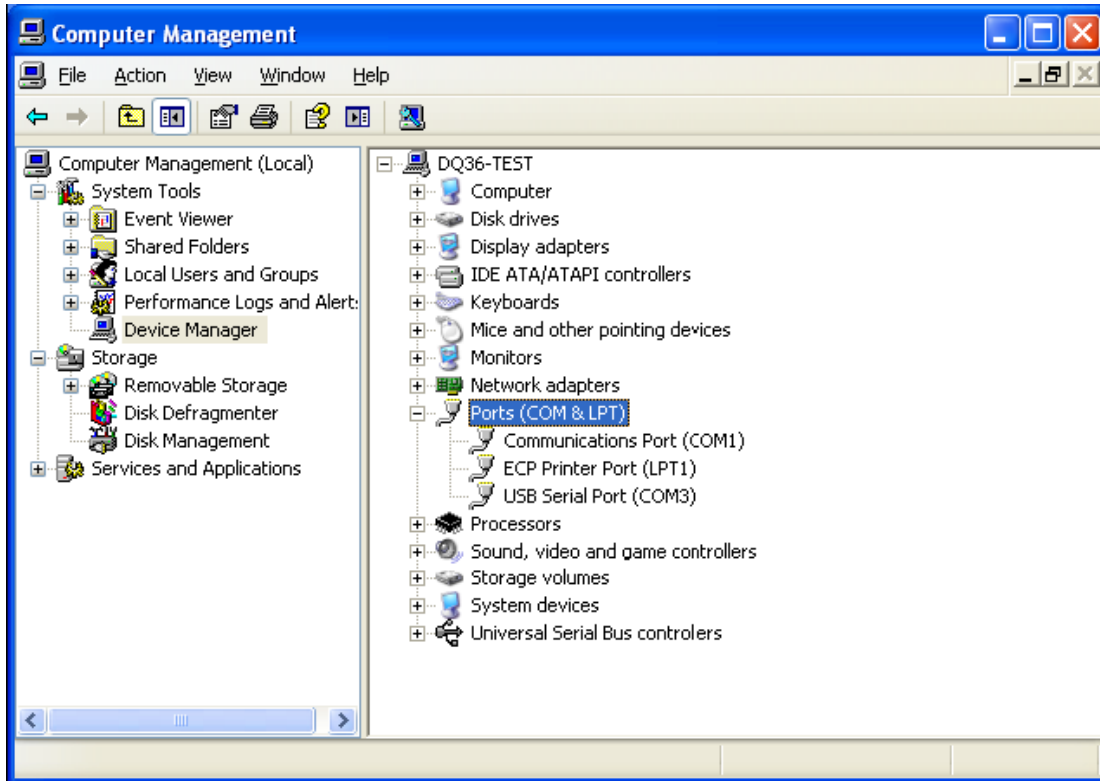
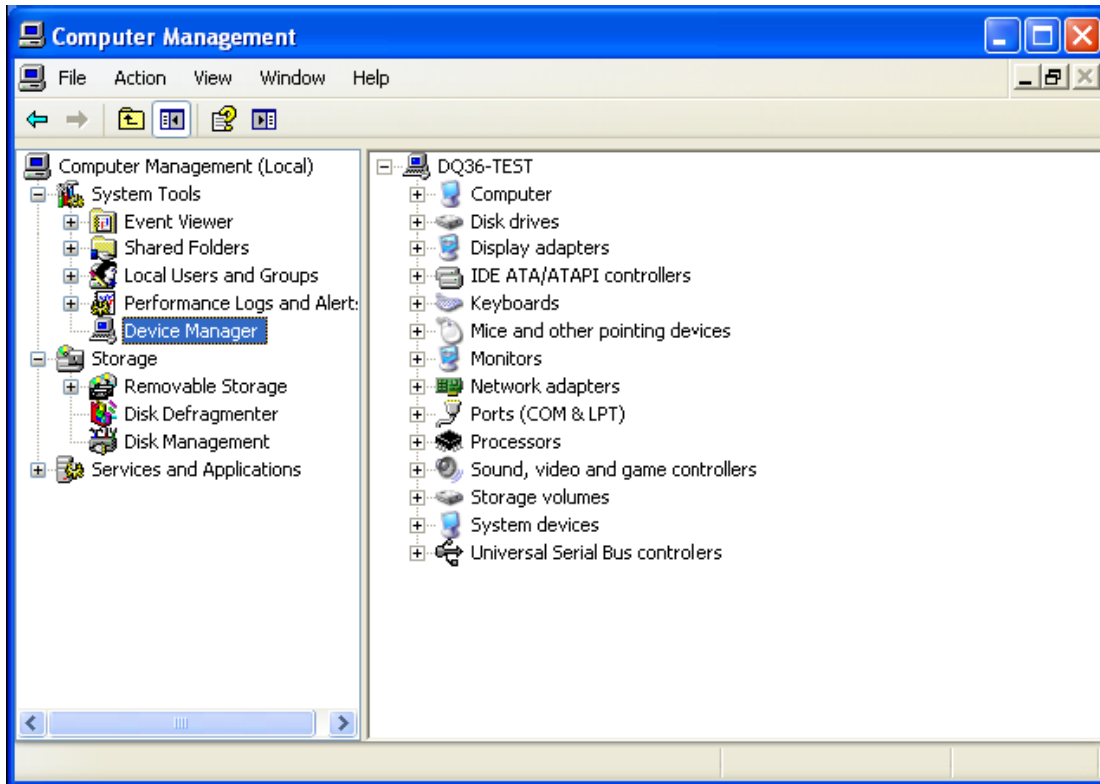

Step 4: Right click "USB Serial Port (COM6)" and then click "Properties". The dialog box of properties will then pop up.

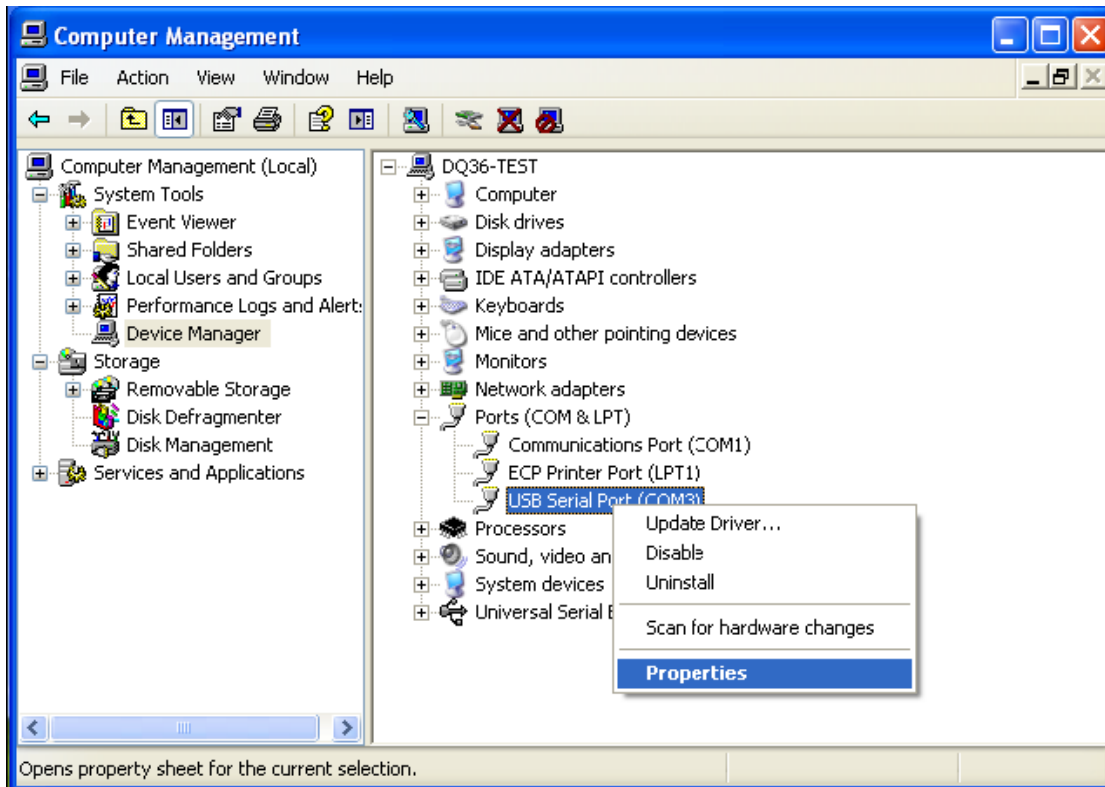

Step 5: Then click "Port Settings" in the dialog box.

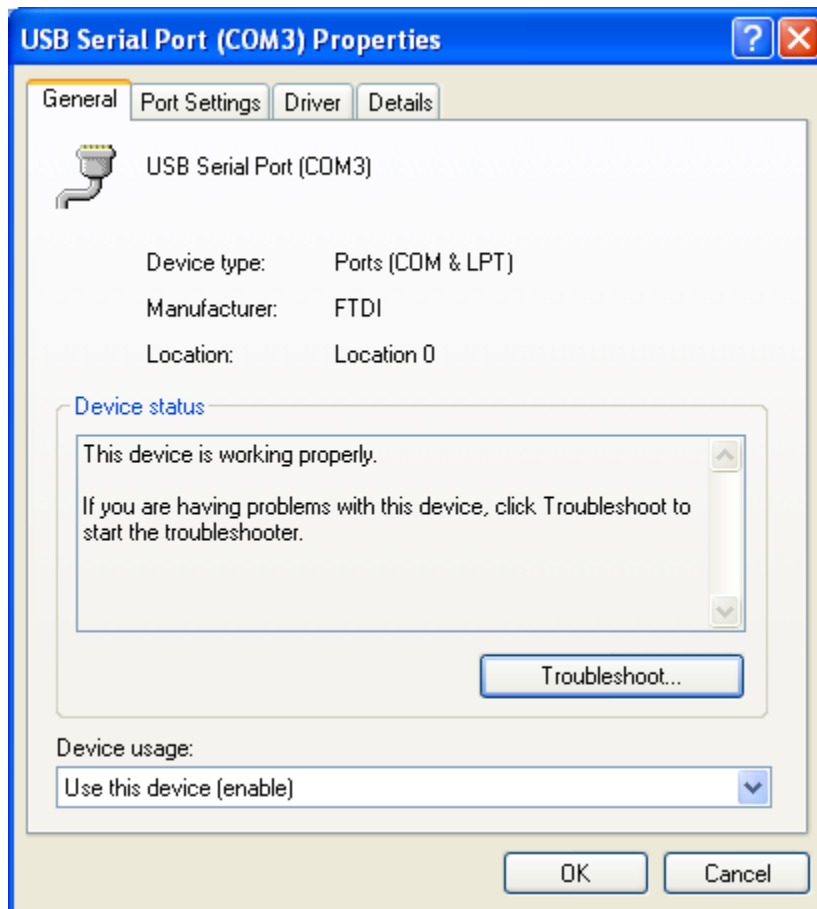

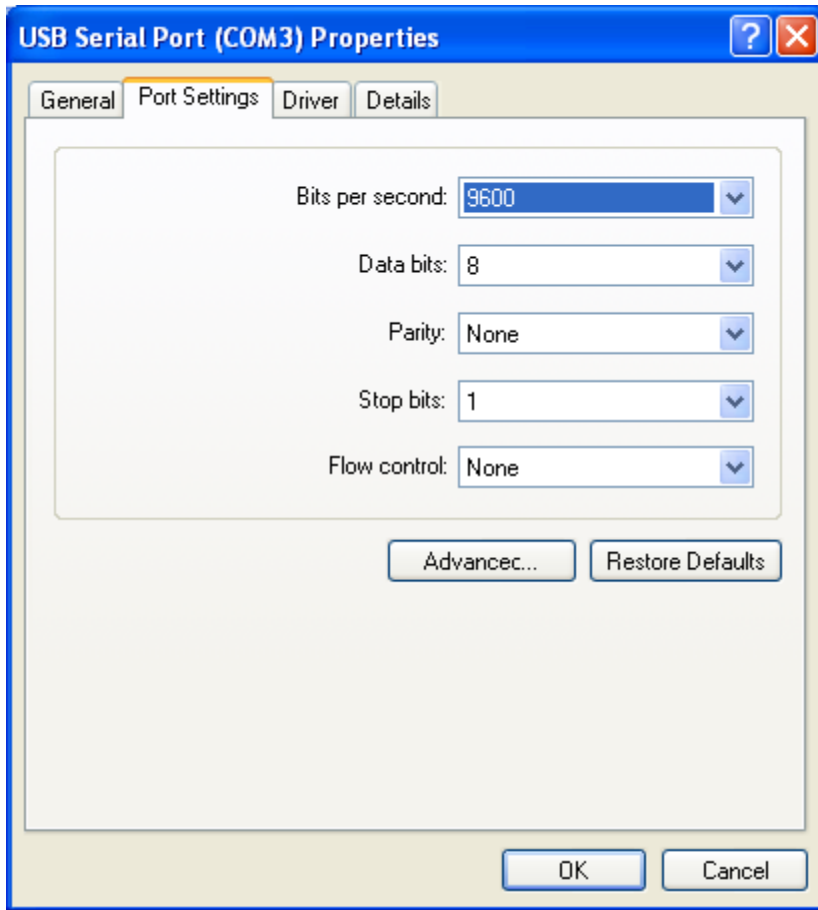

Step 6: Click "Advanced" and then a new dialog box will pop up. Find the "Serial Enumerator" in the miscellaneous options and cancel the tick. Click "OK" to exit.

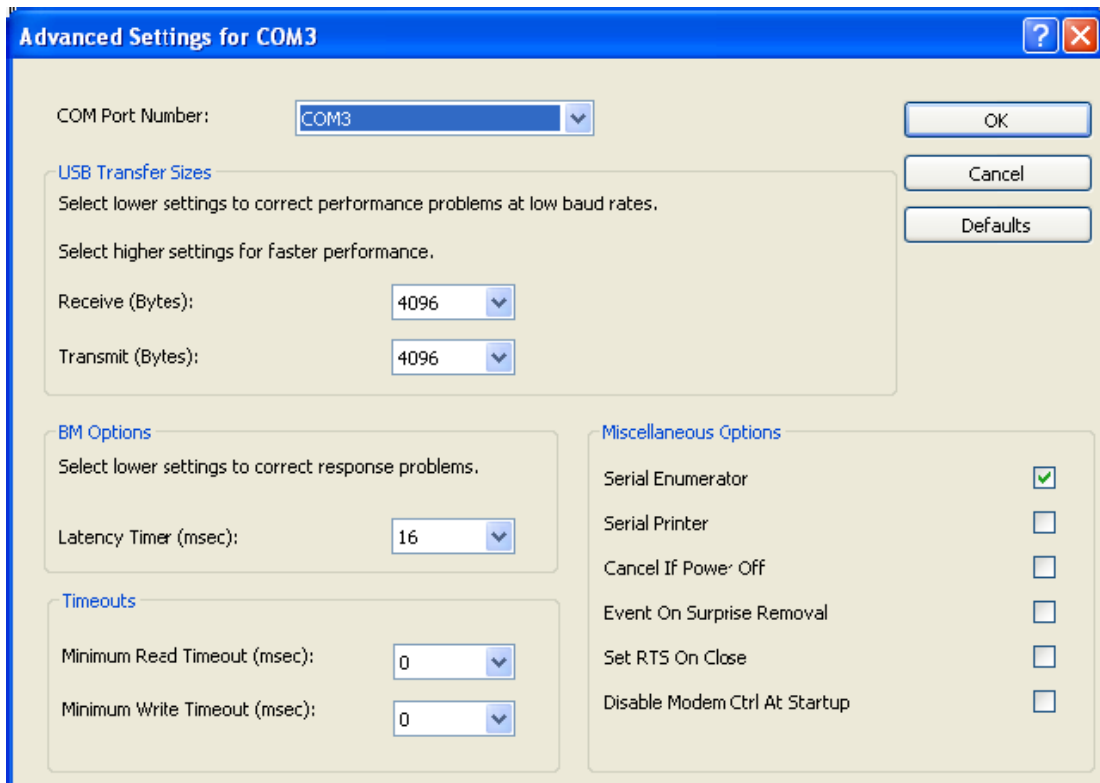

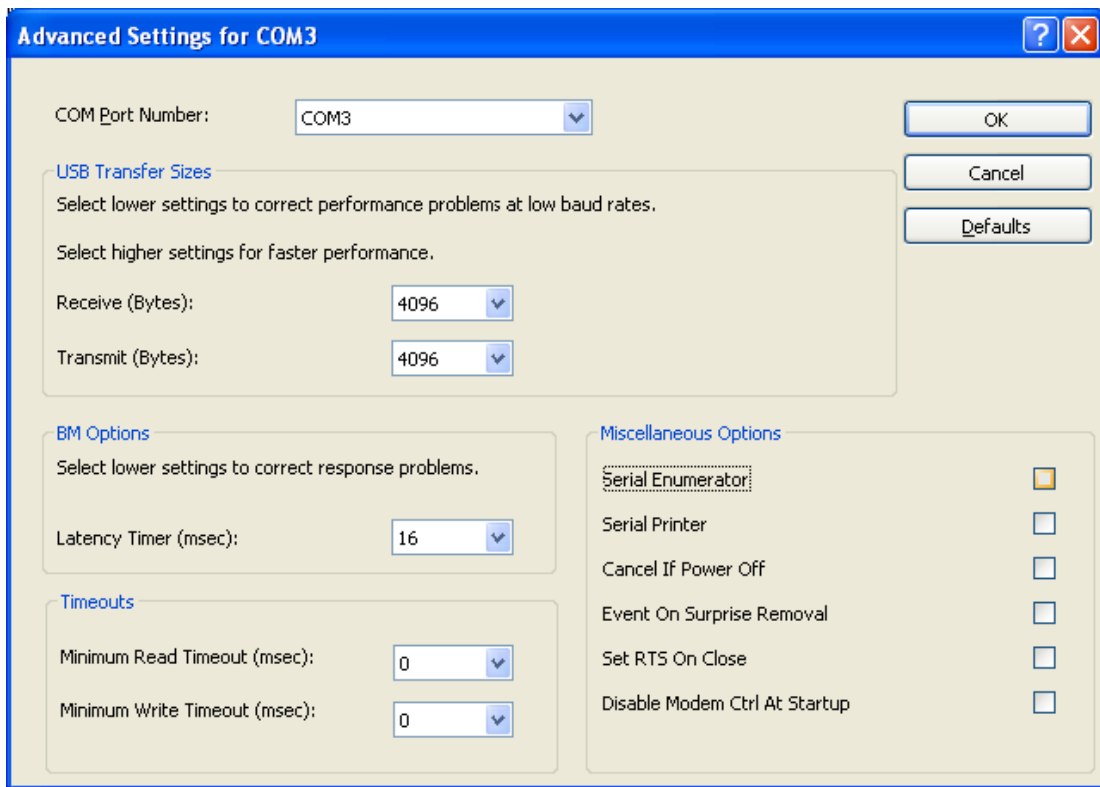

Usage of Converter Configuring Software:

When the converter is working, hold the button "SET" for 5 seconds. Function LED will be flickering, indicating that the converter has entered the baud rate setting mode. Then you can use the converter configuring software to set the baud rate of converter. Baud rate is supported by the converter (baud rate of air conditioner's communication interface matches with the baud rate of USB interface automatically):

Ex-factory defaulted baud rate: (unit: bps)

AC interface	Baud rate of AC interface	Baud rate of USB interface
CAN	20000/50000self-adaptive	115200
HBS	57600	38400
RS485	9600	9600

Baud rate look-up table for RS485 interface (unit: bps)

RS485	4800	9600	19200	38400	57600	115200
USB interface	4800	9600	19200	38400	57600	115200

Baud rate look-up table for HBS interface (unit: bps)

HBS	9600	19200	38400	57600
USB	4800	9600	19200	38400

Baud rate look-up table for CAN interface (unit: bps)

CAN	20000	50000	100000	125000
-----	-------	-------	--------	--------

GMV5 Home DC Inverter Multi VRF Units

USB	115200	115200	256000	256000
-----	--------	--------	--------	--------

- Double click the desktop shortcut.



- Select the needed communication serial port and language in “System Settings”.

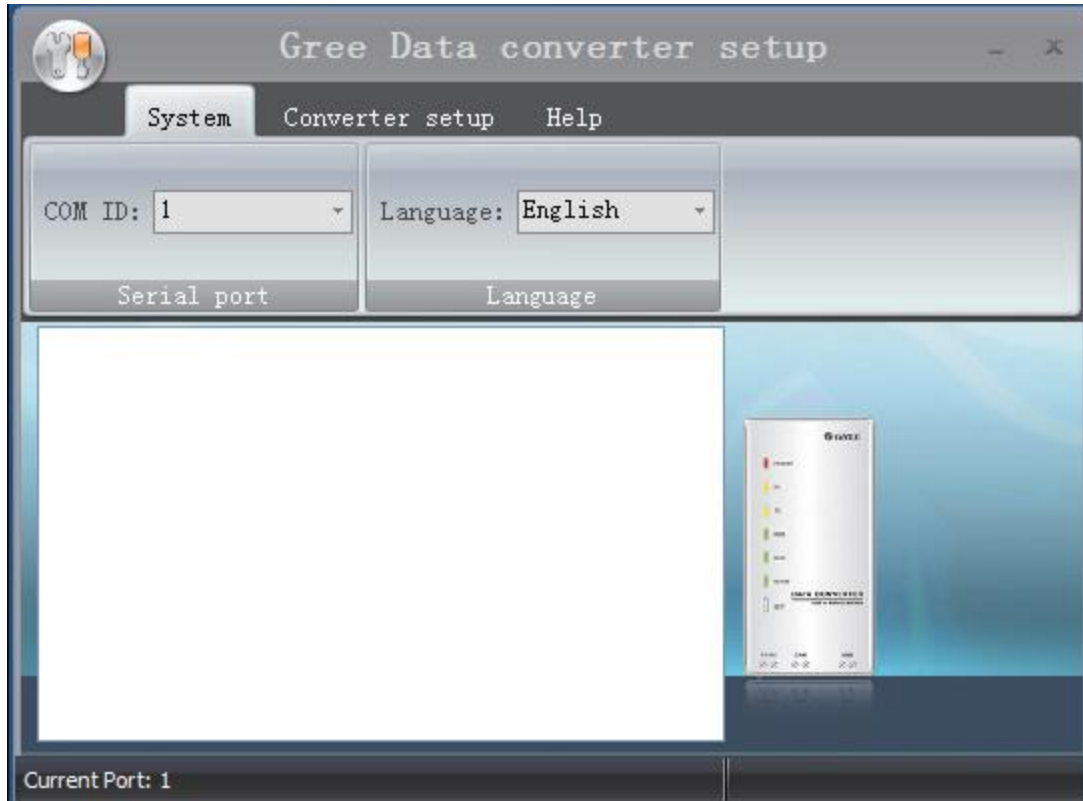

- Select the function that is to be set and the corresponding baud rate (refer to the look-up table) in “Converter Setup”. Then click “Set”.

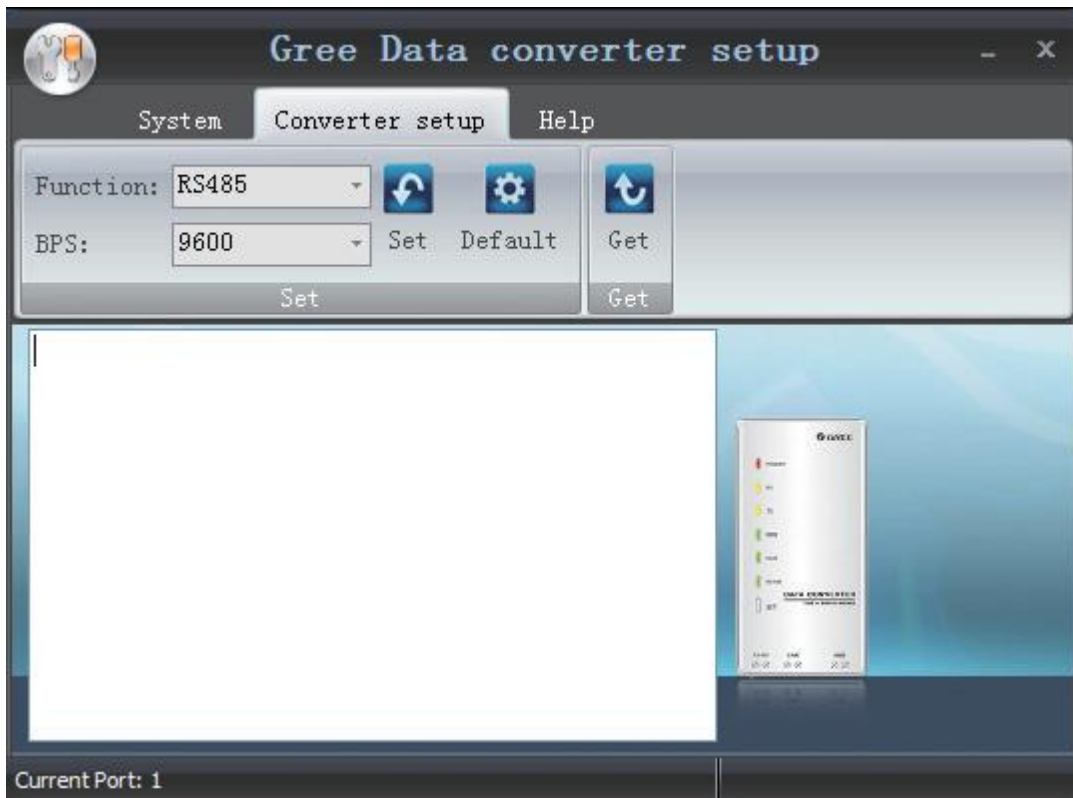

- If you want to restore ex-factory settings, click “Default” to restore the default settings.

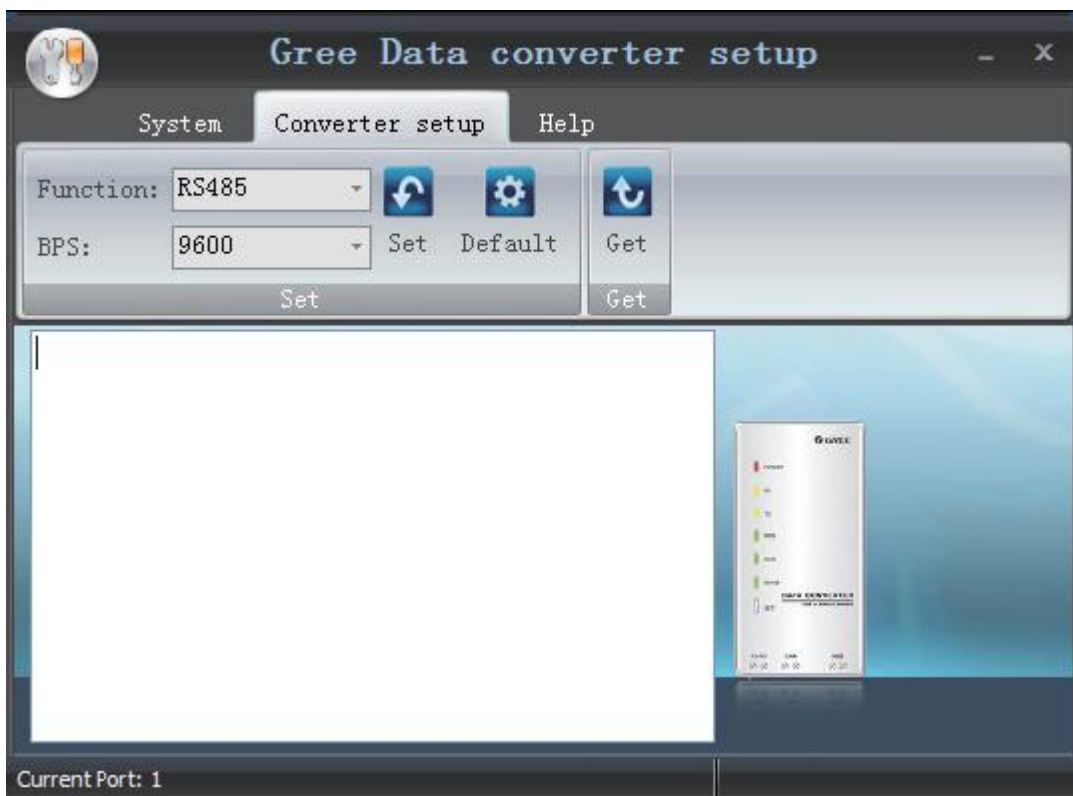

- Click “Get” to get the current setting details of converter.

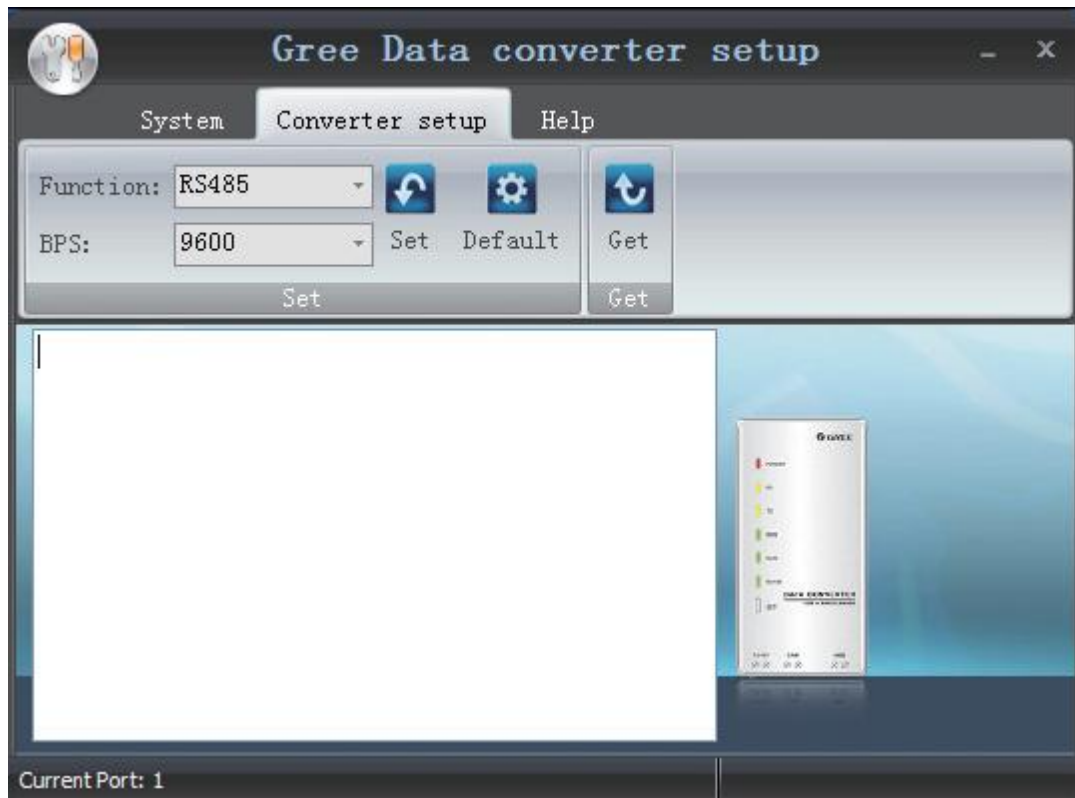

6. Debugging of Software

6.1 Flowchart of Debugging

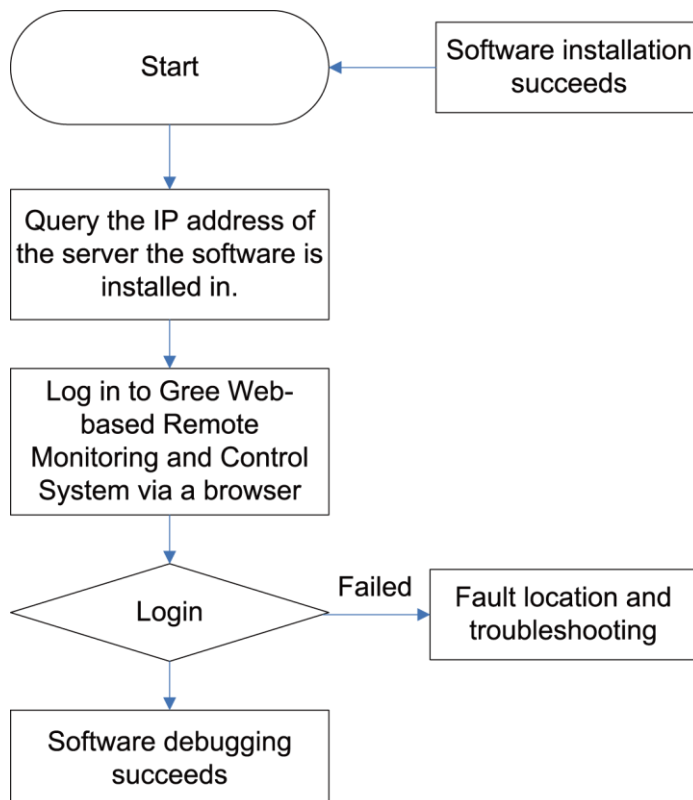

This is a simplified software debugging procedure. For details, please read the following section.

6.2 Troubleshooting

6.2.1 Installation Faults

- Faults that may occur during Gree Debugger setup.

After you click "Install Gree Debugger" to run, the following prompt is displayed.

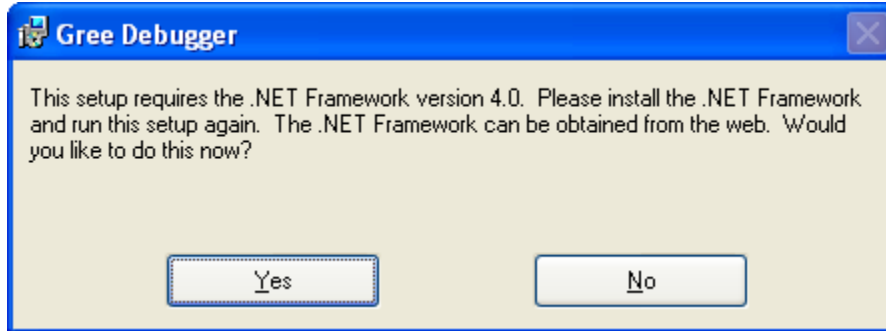

Cause:

.Net Framework 4.0 is not installed.

Troubleshooting: Install .Net Framework 4.0 first and then install Gree Debugger.



JF00302675

GREE ELECTRIC APPLIANCES, INC. OF ZHUHAI

Add: West Jinji Rd, Qianshan, Zhuhai, Guangdong, China, 519070

Tel: (+86-756) 8522218 Fax: (+86-756) 8669426

E-mail: gree@gree.com.cn www.gree.com

For continuous improvement in the products, Gree reserves the right to modify the product specification and appearance in this manual without notice and without incurring any obligations.