



Service Manual

DC INVERTER VRF SYSTEM SERVICE MANUAL(R410A)

CONTENTS

PRODUCT	1
1 PRODUCT LIST	1
2 NOMENCLATURE	2
2.1 Nomenclature of outdoor units	2
3 PRODUCT FEATURES	3
3.1 General introduction	3
3.2 Features	3
4 SPECIFICATIONS	4
4.1 Specifications	4
4.2 Operation range	6
5 PRODUCT CAPACITY CORRECTION	7
5.1 Correction factor of indoor and outdoor temperature	7
5.2 Correction factor of pipe length and height difference	8
6 PRINCIPAL OF OPERATION	8
CONTROL	11
1 UNITS' CONTROL	11
1.1 Schematic diagram of units' control	11
1.2 Interpretation on the schematic diagram	11
2 REMOTE MONITORING SYSTEM	11
2.1 General introduction	11
3 MONITORING SOFTWARE	12
3.1 Function introduction	12
3.2 Connection of computer and units	12
3.3 Parts introduction	13
INSTALLATION	57
1 ENGINEERING INSTALLATION PREPARATION AND NOTICE	57
1.1 Installation notice	57
1.2 Installation key points and importance	57
2 INSTALLATION MATERIALS SELECTION	58
2.1 Refrigerant piping	58
2.2 Condensate water pipe	59
2.3 Insulation material	59
2.4 Communication cable and control cable	59
2.5 Power cable	60
2.6 Hanger rod and support	60
3 INSTALLATION OF OUTDOOR UNIT	60
3.1 Check before installation	60
3.2 Selection of installation site	60
3.3 Carrying and installing outdoor unit	60
3.4 Installation notices	61
3.5 Fixing and damping of unit	61
3.6 Outline dimension and position of installation hole	61
3.7 Installation space requirement	63
DEBUGGING & MAINTENANCE	64
DEBUGGING & MAINTENANCE	65
1 DEBUGGING OF UNIT	65
1.1 Preparation for debugging	65
1.2 Debugging of unit	66
1.3 Parameters reference value for the normal operation of unit	69
2 MALFUNCTION LIST	70
2.1 Malfunction list for the wired controller	70
2.2 Status display table for indicators on main board of outdoor unit	71
3 TROUBLESHOOTING	73
4 POWER DISTRIBUTION OF UNIT	83
4.1 Power distribution of unit	83
4.2 Main electric parts	83

4.3 Circuit diagram	84
5 REMOVAL OF PARTS.....	88
5.1 Key parts	88
5.2 Removal of key parts	90
6 COMMON MAINTENANCE	111
6.1 Vacuum drying for the system	111
6.2 Fill and charge refrigerant	112
6.3 Airtightness test.....	116
7 EXPLODED VIEW OF UNIT AND PARTS' LIST	117
7.1 Exploded view for outdoor unit and parts' list.....	117

PRODUCT

PRODUCT

1 Product List

Model	Product Code	Cooling Capacity (kW)	Heating Capacity (kW)	Power Supply	Refrigerant	Appearance
GMV-80WL/A-T	CN850W0530	8	9	220-240V 50Hz 208-230V 60Hz	R410A	
GMV-100WL/A-T	CN850W0430	10	11			
GMV-121WL/A-T	CN850W0420	12.1	13.0			
GMV-80WL/C-T	CN850W0590	8	9			
GMV-100WL/ C -T	CN850W0600	10	11			
GMV-121WL/C-T	CN850W0640	12.1	13.0			
GMV-120WL/A-T	CN850W0180	12.1	14	220-240V 50Hz 208-230V 60Hz	R410A	
GMV-140WL/A-T	CN850W0170	14	16.5			
GMV-160WL/A-T	CN850W0160	16	18.5			
GMV-120WL/A-X	CN850W0260	12.1	14	380-415V 3N~50Hz 380-415V 3N~60Hz	R410A	
GMV-140WL/A-X	CN850W0250	14	16.5			
GMV-160WL/A-X	CN850W0240	16	18.5			
GMV-120WL/C-T	CN850W0440	12.1	14.0	220-240V 50Hz 208-230V 60Hz	R410A	
GMV-140WL/C-T	CN850W0450	14.0	16.5			
GMV-160WL/C-T	CN850W0460	16.0	18.0			
GMV-120WL/C-X	CN850W0470	12.1	14.0	380-415V 3N~50Hz 380-415V 3N~60Hz	R410A	
GMV-140WL/C-X	CN850W0480	14.0	16.5			
GMV-160WL/C-X	CN850W0490	16.0	18.5			

Model	Product Code	Cooling Capacity (kW)	Heating Capacity (kW)	Power Supply	Refrigerant	Appearance
GMV-H224WL/A-X	CN850W0330	22.2	24	380-415V 3N~50Hz 380-415V 3N~60Hz	R410A	
GMV-H280WL/A-X	CN850W0340	27.9	30			
GMV-H335WL/A-X	CN850W0350	33.3	35.1			
GMV-H224WL/A-X	CN850W0331	22.4	24	380-415V 3N~50Hz 380-415V 3N~60Hz	R410A	
GMV-H280WL/A-X	CN850W0341	28	30			
GMV-H335WL/A-X	CN850W0351	33.5	35			
GMV-224WL/C-X	CN850W0510	22.4	24	380-415V 3N~50Hz 380-415V 3N~60Hz	R410A	
GMV-280WL/C-X	CN850W0520	28	30			
GMV-335WL/C-X	CN850W0500	33.5	35			

2 Nomenclature

2.1 Nomenclature of outdoor units

GMV	□	-	□	□	H	□	W	□	/	□	□	□	□
1	2		3	4	5	6	7	8		9	10	11	12

No.	Description	Options
1	Product code	GMV-Gree Multi VRF Units
2	Suitable climate	Blank-T1 condition; T2-low temperature climate; T3-high temperature climate
3	Unit type	DC Inverter —omit
4	Function code	Q—Heat Recovery; S—Water Heater; W—Water-cooled Unit; X—Fresh Air Unit Leave blank if above functions are unavailable.
5	Code	H – Only for GMV-H224WL/A-X, GMV-H280WL/A-X, GMV-H335WL/A-X
6	Code of cooling capacity	Nominal capacity/100(W)
7	Code of outdoor unit	W
8	Unit structure	M—Modular (top discharge); L—Non-modular (side discharge); blank—Non-modular (top discharge)
9	Refrigerant	R410A —omit
10	Design No.	Named in order of A, B, C, or combined with 1, 2, 3...
11	Power supply	7000~18000W, 1 phase—omit
12	Export	T – 220-240V 50Hz or 208-230V 60Hz X – 380-415V 3N~50Hz or 380-415V 3N~60Hz

3 Product Features

3.1 General introduction

Gree DC Inverter Multi VRF System II is the latest generation of DC inverter units. One set of air-cooled outdoor unit can be connected with multiple direct evaporation indoor units that are of the same or different forms and capacity. This refrigerating system can directly provide air conditioning for one or more areas, and is applicable for residential and light commercial uses. It features high energy efficiency, strong anti-interference capability, long connectable pipe, wide operation range, good sound quality, intelligent capacity regulation, complete protection, etc.

3.2 Features

(1) Super high energy efficiency

The 2nd generation of DC Inverter Multi VRF System adopts DC motor to realize complete direct current and upgrade the energy efficiency. EER is up to 3.97 and COP can reach 4.28.

(2) New generation CAN bus communication

Due to the latest communication method—CAN Bus Communication, system's anti-interference capability is stronger and the control on indoor units is more accurate, with higher reliability. Specialized shield wire is no more needed and ordinary communication wire can be applied in the construction, which has increased the installation flexibility.

(3) Long connection pipe

The maximum length of connection pipe is 300m (in total) and the farthest connection pipe between indoor and outdoor units can be 120m's long, which has extended the installation condition and reduced the limit of installation distance.

(4) Wide operation range

Units can operate reliably in a wide temperature range (cooling: -5~52°C, heating: -20~27°C).

(5) Fine sound quality

Through a series of optimized measures, system has reduced the throttle noise and oil return noise of indoor units, gas bypass noise, etc. so that units are more comfortable regarding sound quality.

(6) Intelligent PID capacity regulation

With the independently developed PID capacity regulation technology, units are able to control the indoor ambient temperature more quickly and reduce the fluctuation of room temperature.

(7) Complete protection

Units are equipped with a series of protection to accurately identify errors and protect the units, which has ensured reliable and safe operation.

4 Specifications

4.1 Specifications

Model		GMV-120 WL/A-T	GMV-140 WL/A-T	GMV-160 WL/A-T	GMV-120 WL/A-X	GMV-140 WL/A-X	GMV-160 WL/A-X	GMV-H224 WL/A-X	GMV-H280 WL/A-X	GMV-H335 WL/A-X	
Cooling capacity	kW	12.1	14	16	12.1	14	16	22.2	27.9	33.3	
Heating capacity	kW	14	16.5	18.5	14	16.5	18.5	24	30	35.1	
Circulating air volume	m ³ /h	6000	6300	6600	6000	6300	6600	8000	11000	11000	
Noise	dB (A)	55	56	58	55	56	58	60	62	63	
Refrigerant charge volume	kg	5	5	5	5	5	5	5.5	7.1	8	
Energy efficiency level	Level	1	1	1	1	1	1	1	1	1	
Power supply		220-240V ~ 50Hz 208-230V ~ 60Hz	220-240V ~ 50Hz 208-230V ~ 60Hz	220-240V ~ 50Hz 208-230V ~ 60Hz	380-415V 3N~50Hz 380-415V 3N~60Hz	380-415V 3N~50Hz 380-415V 3N~60Hz	380-415V 3N~50Hz 380-415V 3N~60Hz	380-415V 3N~50Hz 380-415V 3N~60Hz	380-415V 3N~50Hz 380-415V 3N~60Hz	380-415V 3N~50Hz 380-415V 3N~60Hz	
Rated power input	Cooling	kW	3.05	3.98	4.85	3.05	3.98	4.85	5.8	7.2	9.1
	Heating	kW	3.27	3.99	4.67	3.27	3.99	4.67	5.4	6.9	8.2
Unit Dimensions (mm)(WxDxH)		900×340×1345						940×320×1430	940×460×1615	940×460×1615	
Package Dimensions (mm)(WxDxH)		998×458×1515						1038×438×1580	1038×578×1765	1038×578×1765	
Compressor		QXAS-F428zX050A			QXAS-F428zX050C			LNB53FC AMC	E656DHD- 65D2G	E706DHD- 72D2G	
Water-proof level		IPX4	IPX4	IPX4	IPX4	IPX4	IPX4	IPX4	IPX4	IPX4	
Suitable climate		T1	T1	T1	T1	T1	T1	T3	T3	T3	
Connection pipe	Gas	m m	Φ15.9	Φ15.9	Φ19.05	Φ15.9	Φ15.9	Φ19.05	Φ19.05	Φ22.0	Φ25.4
	Liquid	m m	Φ9.52	Φ9.52	Φ9.52	Φ9.52	Φ9.52	Φ9.52	Φ9.52	Φ9.52	Φ12.7
	Connection Method		Bell mouth connection	Bell mouth connection	Bell mouth connection	Bell mouth connection	Bell mouth connection	Bell mouth connection	BRAZE connection	BRAZE connection	BRAZE connection
Net weight		kg	110	110	110	120	120	120	133	166	177

Model		GMV-12 0 WL/C-T	GMV-14 0 WL/C-T	GMV-16 0 WL/C-T	GMV-12 0 WL/C-X	GMV-14 0 WL/C-X	GMV-16 0 WL/C-X	GMV-224WL /C-X	GMV-280WL /C-X	GMV-335WL /C-X	
Cooling capacity	kW	12.1	14.0	16.0	12.1	14.0	16.0	22.4	28	33.5	
Heating capacity	kW	14.0	16.5	18.0	14.0	16.5	18.0	24	30	35	
Circulating air volume	m ³ /h	6000	6300	6600	6000	6300	6600	8000	11000	11000	
Noise (Sound Power Level)	dB(A)	68	69	69	68	69	69	74	74	76	
Refrigerant charge volume	kg	3.3	3.3	3.3	3.3	3.3	3.3	5.5	7.1	8	
Energy efficiency level	Level	1	1	1	1	1	1	1	1	1	
Power supply		220-240 V~ 50Hz 208-230 V~ 60Hz	220-240 V~ 50Hz 208-230 V~ 60Hz	220-240 V~ 50Hz 208-230 V~ 60Hz	380-415 V 3N~50 Hz 380-415 V 3N~60 Hz	380-415 V 3N~50 Hz 380-415 V 3N~60 Hz	380-415 V 3N~50H z 380-415 V 3N~60H z	380-415V 3N~50Hz 380-415V 3N~60Hz	380-415V 3N~50Hz 380-415V 3N~60Hz	380-415V 3N~50Hz 380-415V 3N~60Hz	
Rated power input	Cooling	kW	3.03	3.59	4.75	3.03	3.59	4.75	6.12	7.78	9.57
	Heating	kW	3.27	3.95	4.65	3.27	3.95	4.65	4.90	6.12	7.14
Unit Dimensions (mm)(WxDxH)		900×340×1345						940×320×1430	940×460×1615	940×460×1615	
Package Dimensions (mm)(WxDxH)		998×458×1515						1038×438×1580	1038×578×1765	1038×578×1765	
Compressor		QXAS-F428zX050A			QXAS-F428zX050C			LNB53FCAMC	E656DHD-65D2G	E706DHD-72D2G	
Water-proof level		IPX4	IPX4	IPX4	IPX4	IPX4	IPX4	IPX4	IPX4	IPX4	
Suitable climate		T1	T1	T1	T1	T1	T1	T1	T1	T1	
Connection pipe	Gas	mm	Φ15.9	Φ15.9	Φ19.05	Φ15.9	Φ15.9	Φ19.05	Φ19.05	Φ22.0	Φ25.4
	Liquid	mm	Φ9.52	Φ9.52	Φ9.52	Φ9.52	Φ9.52	Φ9.52	Φ9.52	Φ9.52	Φ12.7
	Connection Method		Flare	Flare	Flare	Flare	Flare	Flare	BRAZE connection	BRAZE connection	BRAZE connection
Net weight		kg	112	112	112	122	122	122	133	166	177

Model		GMV-80WL/A-T	GMV-100WL/A-T	GMV-121WL/A-T	GMV-80WL/C-T	GMV-100WL/C-T	GMV-121WL/C-T	
Cooling capacity	kW	8	10	12.1	8	10	12.1	
Heating capacity	kW	9	11	13.0	9	11	13.0	
Circulating air volume	m ³ /h	3900	4000	4400	3900	4000	4400	
Noise (Sound Power Level)	dB(A)	67	67	68	68	69	70	
Refrigerant charge volume	kg	1.8	1.8	2.0	1.8	1.8	2.0	
Energy efficiency level	Level	1	1	1	1	1	1	
Power supply		220~240V 50Hz 208~230V 60Hz	220~240V 50Hz 208~230V 60Hz	220~240V 50Hz 208~230V 60Hz	220~240V 50Hz 208~230V 60Hz	220~240V 50Hz 208~230V 60Hz	220~240V 50Hz 208~230V 60Hz	
Rated power input	Cooling	kW	2.00	2.70	3.20	2.05	2.70	3.45
	Heating	kW	1.90	2.40	3.00	1.90	2.50	2.70
Unit Dimensions (mm)(WxDxH)		980×360×790						
Package Dimensions (mm)(WxDxH)		1126x474x817						
Compressor		QXAS-D32zX090A						
Water-proof level		IPX4	IPX4	IPX4	IPX4	IPX4	IPX4	
Suitable climate		T1	T1	T1	T1	T1	T1	
Connection pipe	Gas	mm	Φ15.9	Φ15.9	Φ15.9	Φ15.9	Φ15.9	
	Liquid	mm	Φ9.52	Φ9.52	Φ9.52	Φ9.52	Φ9.52	
	Connection Method		Flare	Flare	Flare	Flare	Flare	
Net weight	kg	80	80	85	80	80	85	

Note:

- ① Units conform to design standard: EN 14511.
- ② Specifications may be changed due to product improvement. Please refer to nameplates of the units.
- ③ Noise data are collected from a semi-anechoic room. Decibels may be slightly higher in actual operation due to environmental change.
- ④ Refrigerant charge volume listed in the table is based on the condition where indoor and outdoor units are at a same level and with no connection pipe. Supplementary refrigerant needs to be charged according to actual circumstance.
- ⑤ The sectional area of conducting wire is only applicable when the length is within 15m. If it's over 15m's long, sectional area must be increased accordingly, otherwise, over-current may burn the wires.

4.2 Operation range

Cooling	Outdoor temperature: -5~52℃
Heating	Outdoor temperature: -20℃~27℃

5 Product Capacity Correction

5.1 Correction factor of indoor and outdoor temperature

1) Correction factor of cooling capacity

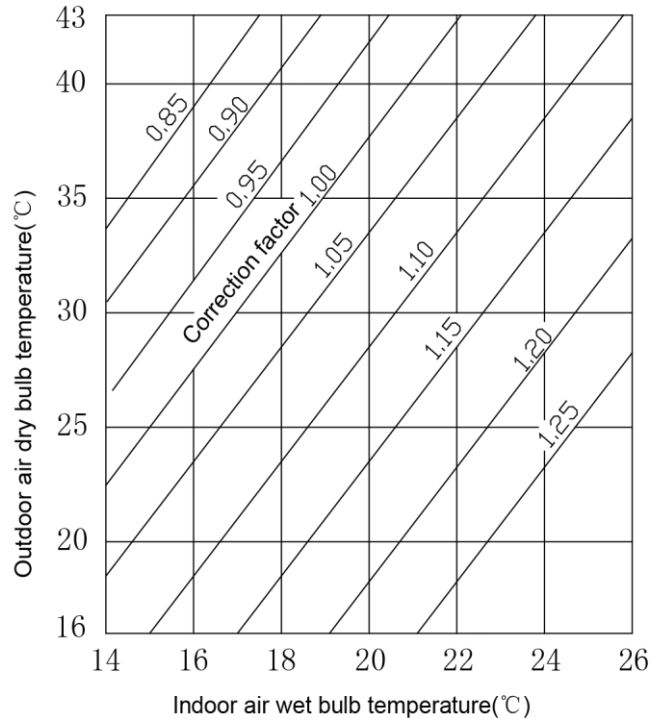

2) Correction factor of heating capacity

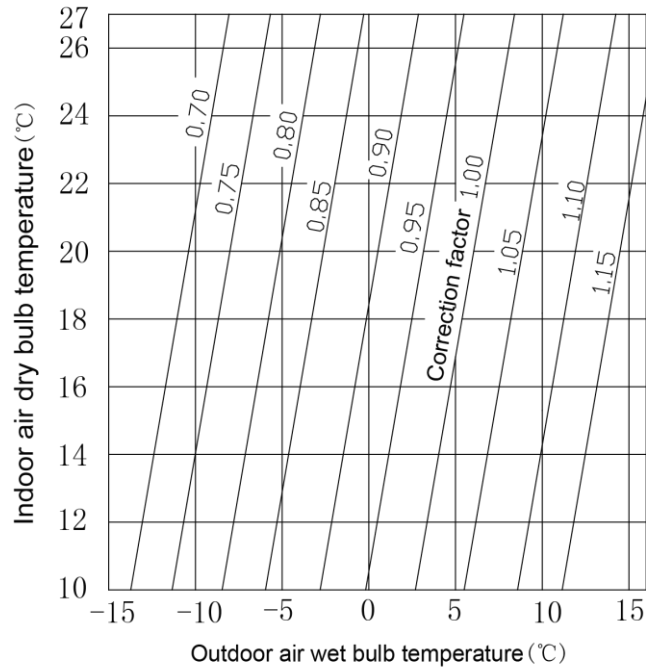

5.2 Correction factor of pipe length and height difference

- Symbol description:

Hp: Height difference in case indoor unit is below outdoor unit (m);

Hm: Height difference in case indoor unit is above outdoor unit (m);

L: Length of one-way equivalent pipe

- Below table shows the capacity variance ratio for 100% full load in standard working condition (thermostat setting is 16°C for cooling and 30°C for heating).

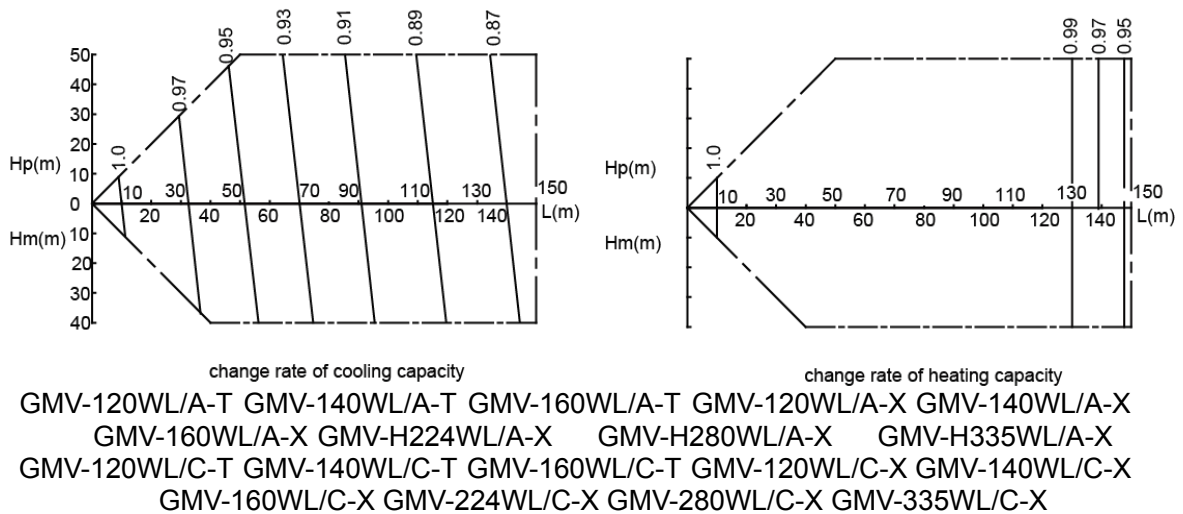
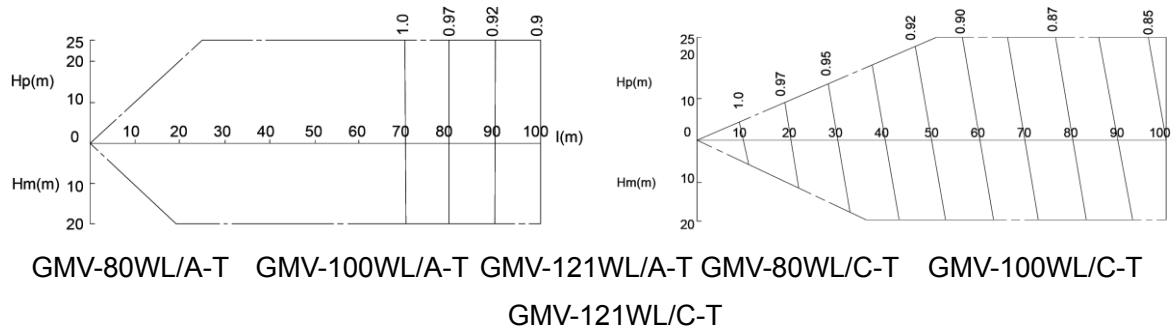

6 Principal of Operation

Components in flowcharts are presented according to the following table:

Name	Compressor	4-way valve	Cut-off valve	One-way valve	Capillary tube
Symbol					
Name	Gas-liquid separator	Pressure switch	Pressure sensor	Axial-flow finned heat exchanger	Electronic expansion valve
Symbol					

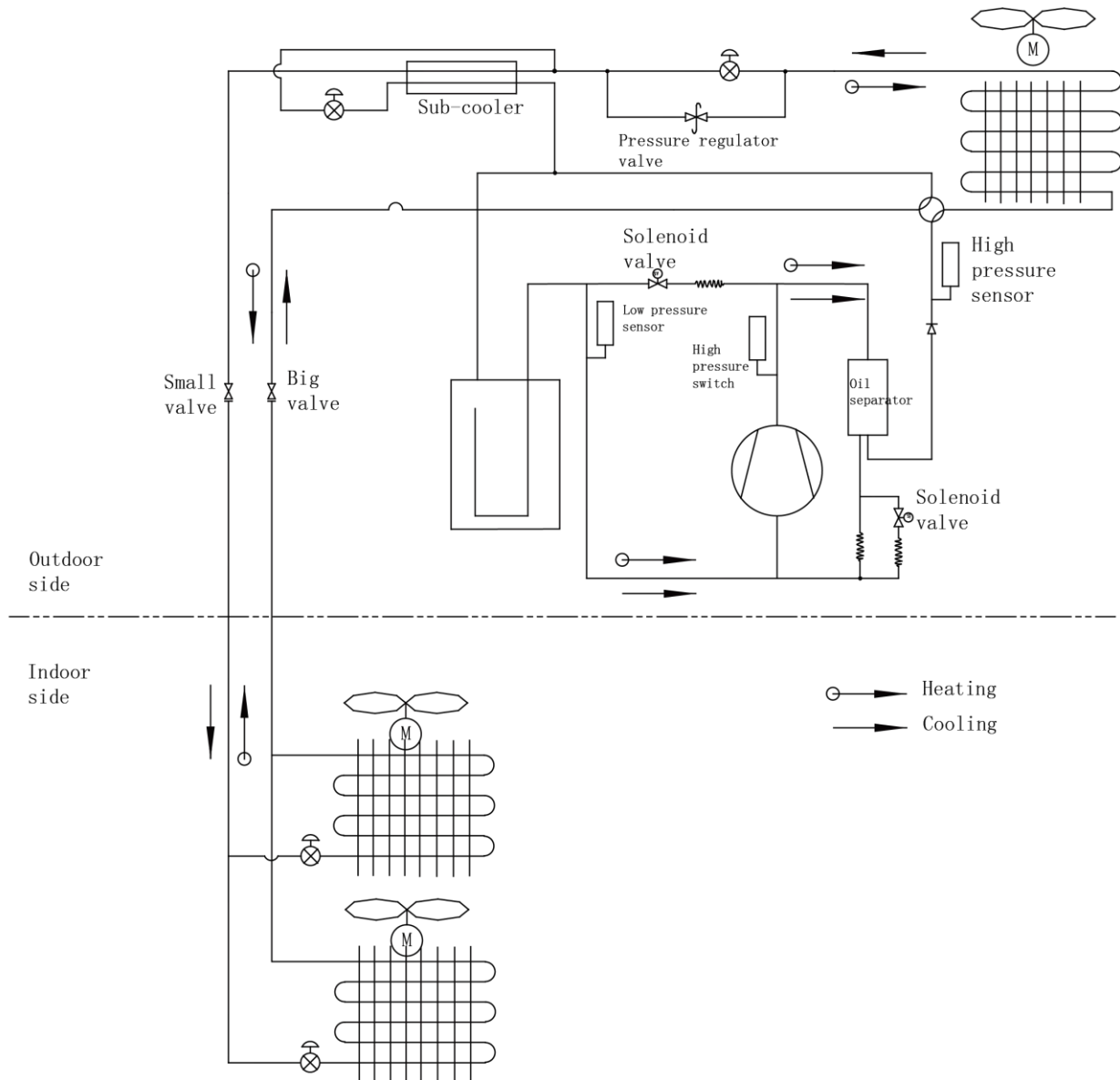

In cooling, the low-temperature and low-pressure refrigerant gas from each indoor heat exchanger will be merged and inhaled by the compressor and then become high-temperature and high-pressure gas, which will later be discharged into outdoor heat exchangers. By exchanging heat with outdoor air, refrigerant will turn to liquid and flow to each indoor unit via Y-type branch or manifold. Pressure and temperature of the refrigerant will then be lowered by throttle elements before it flows into indoor heat exchangers. After exchanging heat with indoor air, refrigerant will become low-temperature and low-pressure gas again and repeat the circulation so as to realize the cooling effect. In heating, 4-way valve will be energized to make refrigerant circulate in a reverse direction of cooling. Refrigerant will release heat in indoor heat exchangers (electric heating elements will also work under certain circumstance and release heat) and absorb heat in outdoor heat exchangers circularly so as to realize the heating effect.

CONTROL

CONTROL

1 Units' Control

1.1 Schematic diagram of units' control

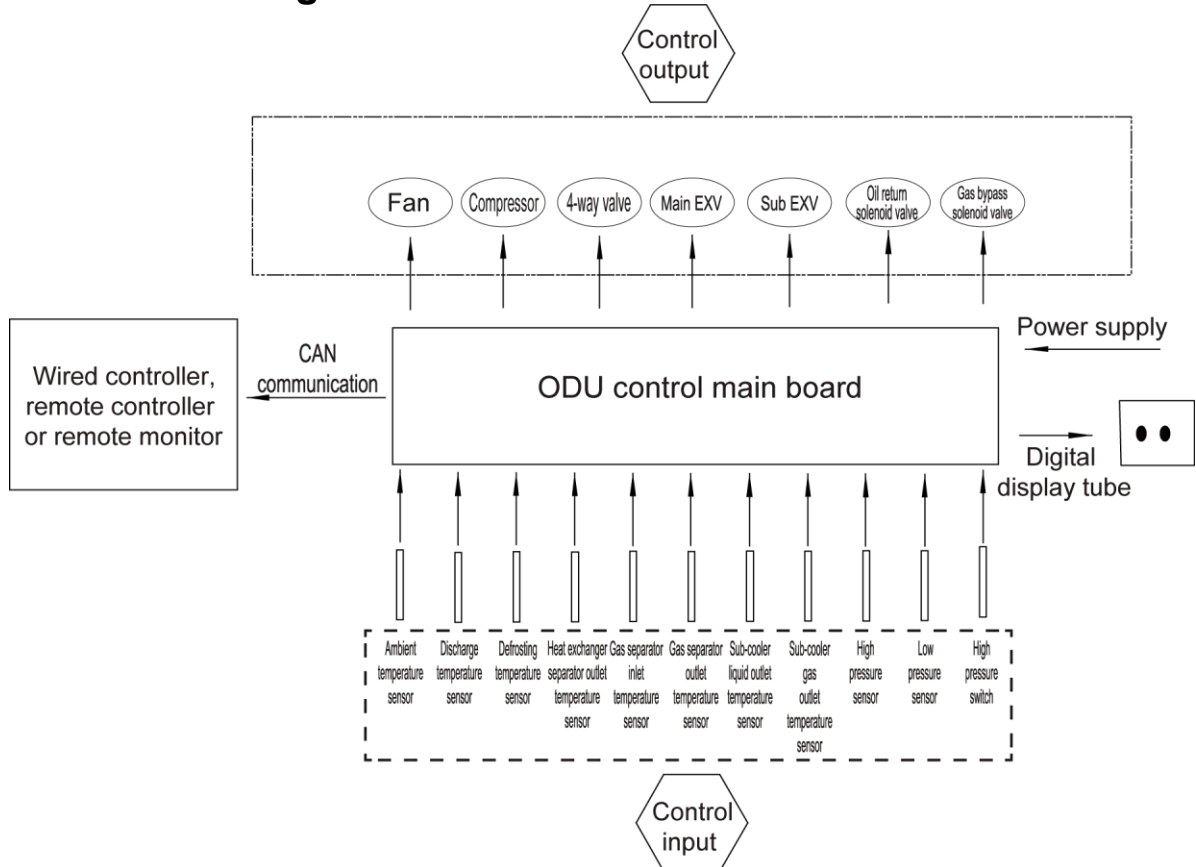

1.2 Interpretation on the schematic diagram

- ◆ High pressure switch is used to identify system's high and low pressure. When pressure is too high, the switch will break off and send a signal to main board. Main board will pass this signal to controller, where the error will be displayed, and stop unit from working.
- ◆ High/low pressure sensor is used to test unit's high/low pressure and send real-time data to controller, which will control each unit's output according to the control logic.
- ◆ Temperature sensors are used to test the tube temperature of the unit and send data to the controller, which will control each unit's output according to the control logic.

2 Remote Monitoring System

2.1 General introduction

Gree CAC Remote Monitoring System is an automatic central management system as well as an intelligent power management system based on internet or local area network. It can provide a complete set of air conditioning solutions, including remote monitor, malfunction alarms and visual management, for the real-time, safe and efficient management of air conditioners.

Gree CAC Remote Monitoring System can save your cost on human resources and equipment management. User can check the running status of air conditioners, turn units on or off, set temperature or other functions just by means of a browser (e.g. IE, Firefox, Chrome) in every corner of the world.

3 Monitoring Software

3.1 Function introduction

With the rapid development of building complex, more and more central air conditioners in various models are used in different places, resulting in inconvenience for the management of air conditioners. Integrating with telecommunication technology and computing software, Gree Commissioning Tool Kits can realize the comprehensive monitor, control and commissioning on central air conditioners. It is an efficient solution for the management of central air conditioners that are separated in different parts of a building. Administrator doesn't need to control every unit on site, but rather controls the units by just sitting in front of a computer. This will not only improve the productivity, but also reduce cost on human resources, property and management.

Gree Commissioning Tool Kits can monitor and control the 2nd generation of Gree Multi VRF. User can monitor and control units by monitoring the computer. This software is an efficient tool for the intelligent air conditioning management as well as installation and after-sales service and commissioning. It can debug units and control units' operation status quickly and conveniently. It will not only improve the productivity but also reduce the difficulty and cost of commissioning and maintenance, providing better and faster service to customers.

3.2 Connection of computer and units

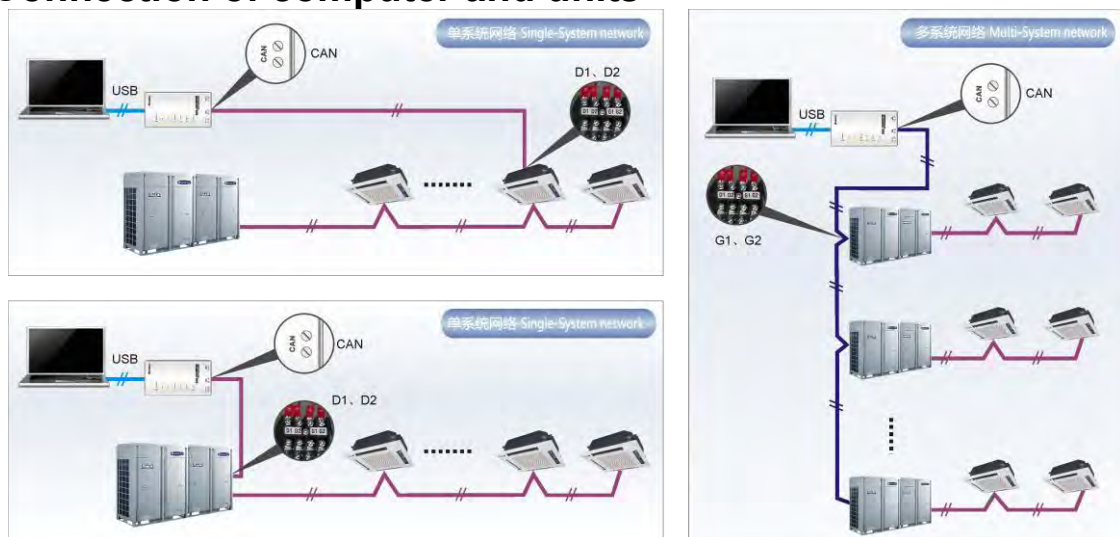

It can be connected with single-system network or multi-system network. In the single-system network, indoor units or outdoor units are connectable, while in the multi-system network, only the master outdoor unit can be connected.

Seen from the diagram, Gree commissioning network is made up of 3 parts:

The 1st part is the monitoring computer, including Gree debugger and Gree USB converter driver that are installed in the computer.

The 2nd part is Gree USB converter, which is to convert the air conditioning communication into computing communication. This part is made up of Gree USB data converter and USB data wire.

The 3rd part is air conditioners, including outdoor units, indoor units and the connection wires. If connection wire is not long enough, it's OK to connect via the patching board of the commissioning tool

kits. In a single-system network, both indoor units and outdoor units can be connected, while in a multi-system network, only the master outdoor unit can be connected.

3.3 Parts introduction

3.3.1 List of parts

Name	Model	Material no.	Remark
Gree USB data converter	MC40-00/B	30118027	Convert the air conditioning communication into computing communication
Gree Commissioning Tool Kits (CD-ROM)	DG40-33/A(C)	36400000003	Include Gree debugger, monitoring software, USB driver and USB converter configuring software.
USB wire	\	40020082	Wire connecting computer's USB interface and converter
Communication board	\	30118015	This board can be used when units are far from the computer.
Board connection wire (1m)	\	4001023229	4-core wire connecting units and converter
Board connection wire (5.5m)	\	4001023214	4-core wire connecting units and converter
Instruction manual	\	66174100018	Instruction manual

3.3.2 Gree USB data converter

3.3.2.1 Functions introduction

Gree USB data converter will convert the RS485, HBS and CAN communication within the air conditioners into the communication that is recognizable by computer's USB interface.

3.3.2.2 Appearance

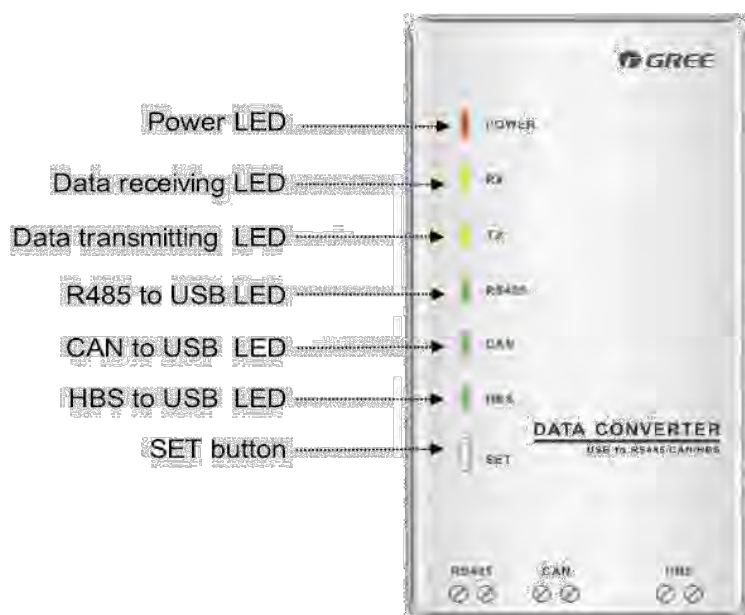

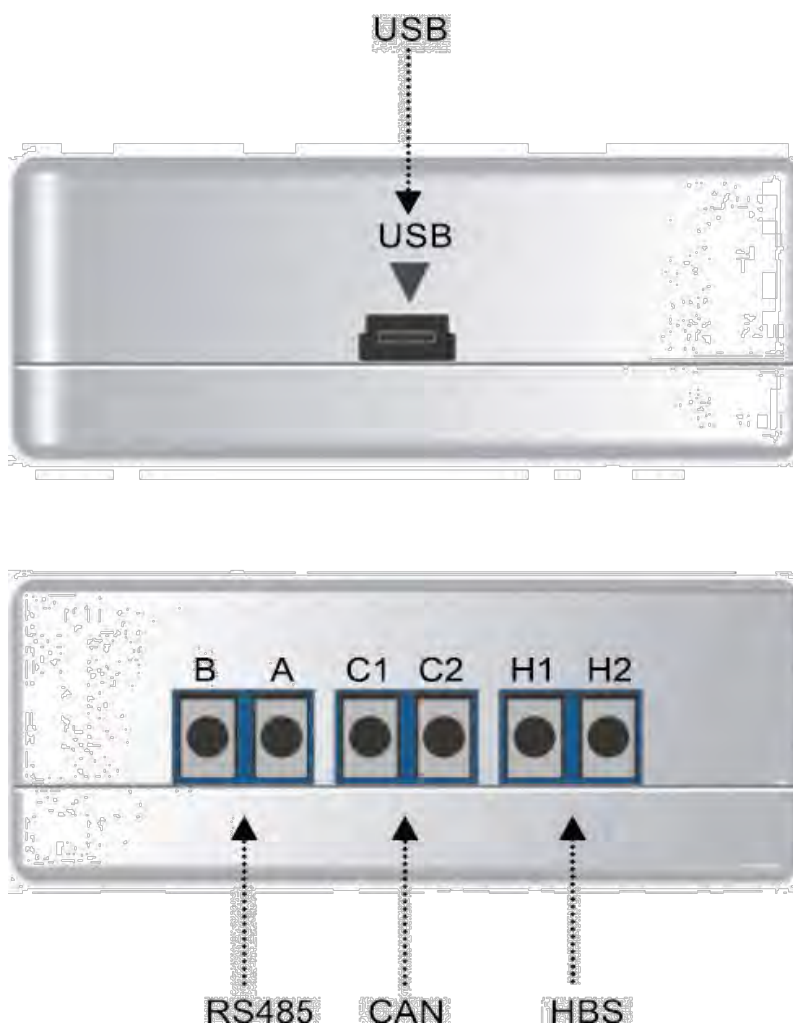

3.3.2.3 Operation instruction

- Power LED: a red light. If the red light is on, it indicates normal power supply. If the red light is off, it indicates the power supply of converter is not normal.
- Communication LEDs: yellow lights. When converter is working and the computer is transmitting data, the TX data transmitting light will be flickering. When units are uploading data to the computer, the RX data receiving light will be flickering.
- When converter is under RS485 data transferring mode, the function LED of RS485 to USB will be on.
- When converter is under CAN data transferring mode, the function LED of CAN to USB will be on.
- When converter is under HBS data transferring mode, the function LED of HBS to USB will be on.
- USB interface: connect USB data wire.
- CAN interface: When converter is under CAN communication mode, connect air conditioner's CAN data interface. CAN interface exhibits no polarity (A and B are equal).

- HBS interface: When HBS converter is under HBS communication mode, connect air conditioner's HBS data interface. HBS interface exhibits no polarity (This interface is not yet available for Gree debugger and the monitoring software).
- RS485 interface: When RS485 converter is under RS485 communication mode, connect air conditioner's RS485 data interface. RS485 interface exhibits polarity and terminal A and B are different.

3.3.2.4 Installation notice

- Install indoors. To avoid collision, it is suggested to place it in the monitoring room together with the computer.
- No need of power supply. Power is supplied through computer's USB interface.

3.3.3 Communication board

Communication board is mainly used for transferring data. It functions similar with a patching board.

Provided that units are far away from the monitoring computer, communication board can be used for connection.

3.3.4 Communication cord

3.3.4.1 USB wire

- Connect USB wire with computer's USB interface at one end and with the USB interface of USB data converter at the other end, as indicated below:



3.3.4.2 Board Connection Wire

- There are 2 board connection wires supplied for the commissioning tool kits. One is 1 meter's long and the other is 5.5 meters' long. They are only different in length. One end of the wire shall connect with air conditioner's communication interface and the other end shall connect with CAN interface of Gree USB converter. As shown below, the wire can be connected to the communication interface of outdoor unit or the communication interface of indoor unit:

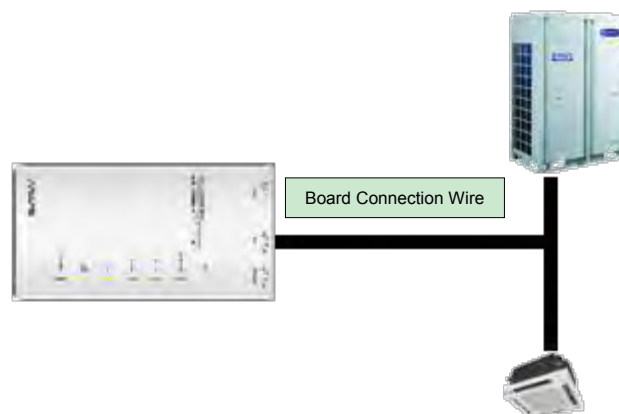

3.4 Software introduction

(1) One-button commissioning

Personnel responsible for the commissioning of air conditioners can start commissioning by pressing one button according to the commissioning logic of software, which will give the commissioning order to units. Then commissioning will be started up automatically step by step. During the commissioning, the corresponding process will be ticked in green on the software interface. If any commissioning process is not normal, it will be displayed in red.

(2) Comprehensive monitoring

The software can monitor every part of the air conditioning system, including functions, equipment and components operating status. The monitoring results will be displayed in text or curve so that user can acquire the operating status of the entire system conveniently and straightforwardly.

(3) Real-time control

Air conditioner's operating time and requirements may be different based on areas and functions. User can set units' parameters on computer according to actual needs, such as the on/off, temperature, fan speed, mode, etc. Meanwhile, the software can also set or view the function parameters of outdoor units, gateway and other equipment. In this way, the management of central air conditioners is realized.

(4) Replay history

Software can replay and save the historical monitoring information in the data base. The replay speed can be selected and the information will be shown in text or curve. This function has greatly saved the time to track problem cause and resolved the difficulty of problem reproduction.

(5) Applicable to multiple series, models and users

Gree Commissioning Tool Kits is applicable to air conditioning system that consists of multiple series and models. Later, it will be developed to cover all series of Gree central air conditioners, such as multi VRF, centrifugal chiller, screw type chiller, ground source heat pump units, modular units, fan coiled units, close control units, etc. It can be used by system and controller designers to develop and monitor units, or used for maintenance and commissioning.

(6) Other functions

For the convenience of users, the software has added functions like connection guide, printing screen, opening database folder, rebuilding database, changing database saving path, etc.

3.4.1 Software installation

3.4.1.1 Installation requirements

(1) Computer Configuration

Memory	1 GB at least 2 GB or above is preferred
Hard Disc	10 GB available
CPU	Core 2 or higher 1 GHz at least 2 GHz or above is preferred
Operation System	Windows Server 2003 SP3 or higher Windows XP SP3 or higher Windows Vista Windows 7

(2) CD Playing

Make sure you have administrator access to the computer and there is a CD-ROM in the computer. Put the CD into the CD-ROM. If it's automatically running, then the following display will be shown. Or double-click the file "Launcher.exe".



For the first time to use Gree Commissioning Tool Kits, install these programmes: .Net Framework 4.0, USB Data Converter, Access Driver (necessary for versions below OFFICE 2007), Gree Debugger.

3.4.1.2 Installation flowchart

Button Graphics

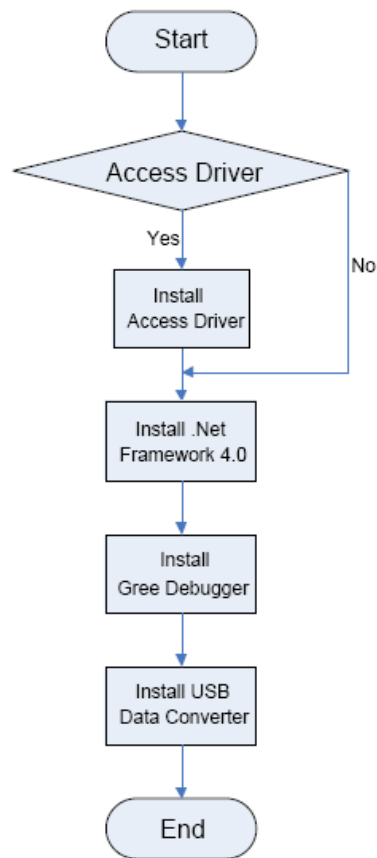

This flowchart describes basically the software installation process. See below for details.

3.4.1.3 Installation process

(1) Install .Net Framework 4.0

- If your computer has installed .Net Framework 4.0 or versions above, there's no need to install again. Otherwise, click "Install .Net Framework 4.0".



- Extracting files

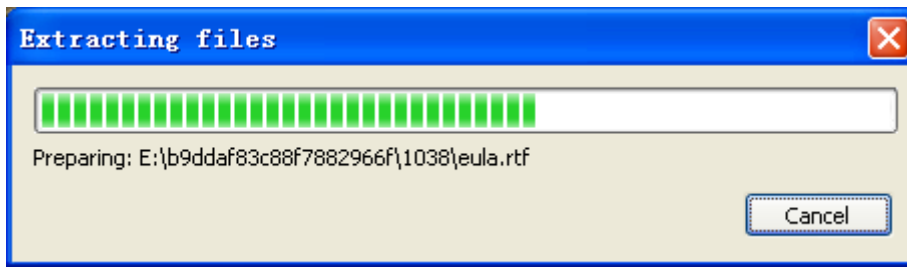

- Click and select "I have read and accept the license terms". Then click "Install".

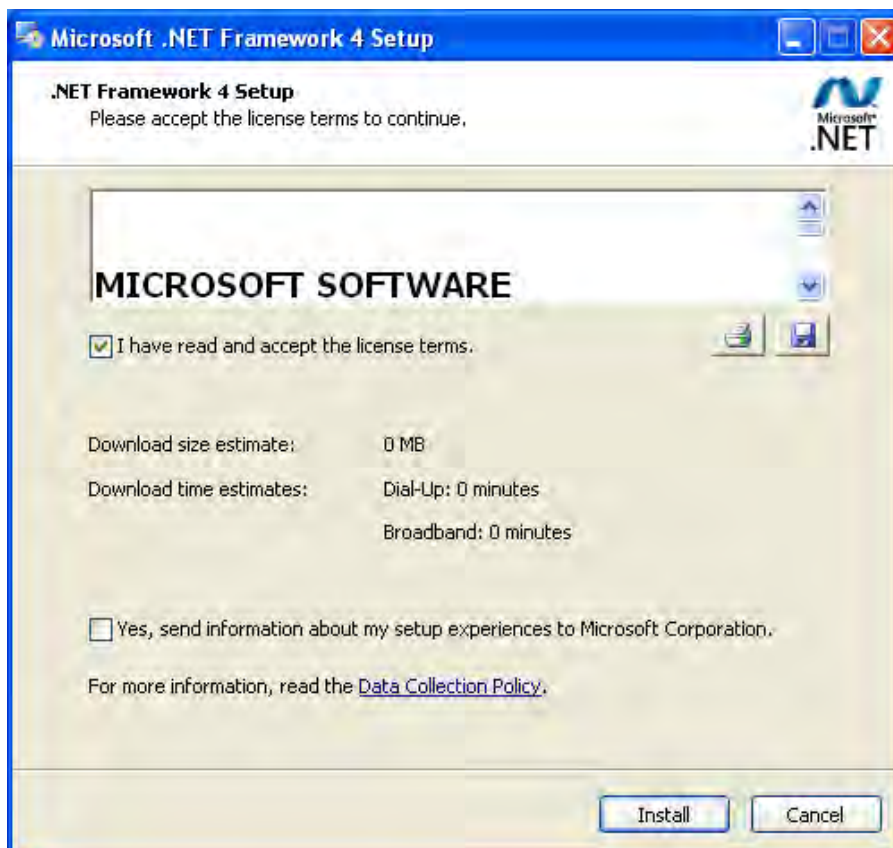

- Installation is in progress.

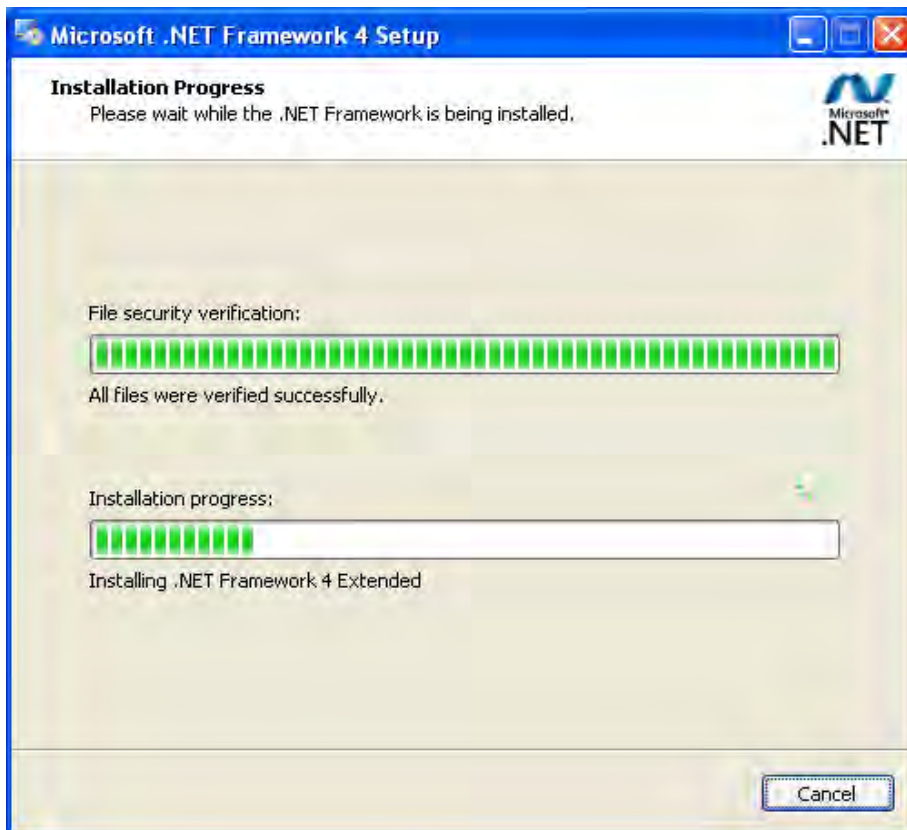

- Click "Finish" to complete the installation.

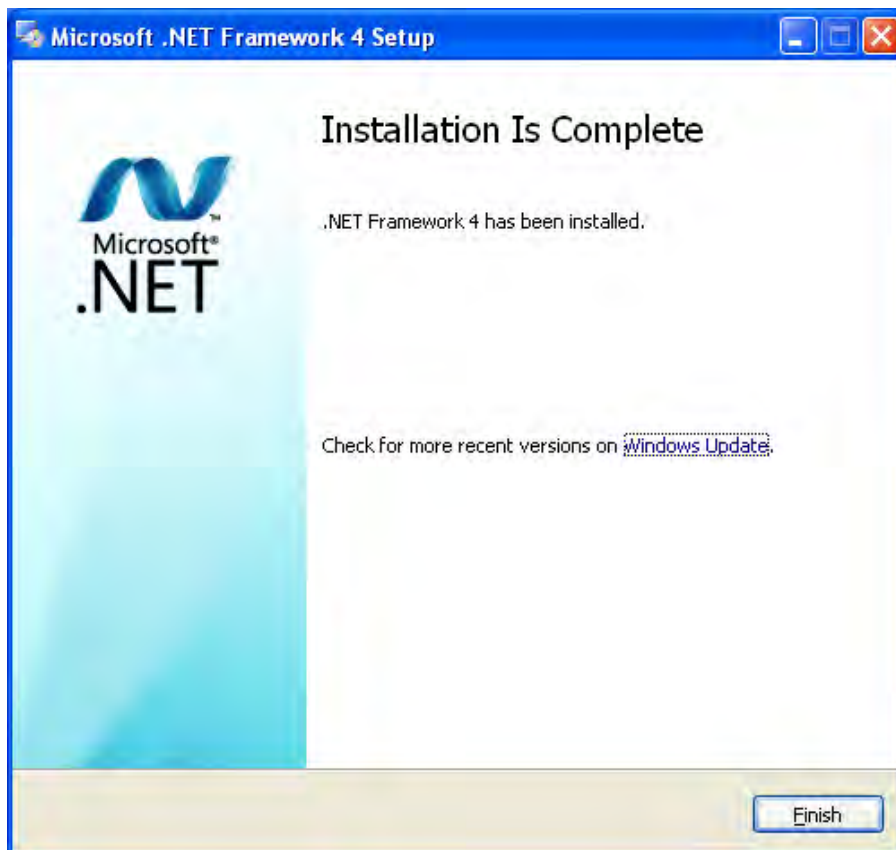

(2) Install Access Driver

- Before operating Gree commissioning software, please first install Access Driver (necessary for versions below OFFICE 2007). Click "Install Access Driver".



- Click "Next".

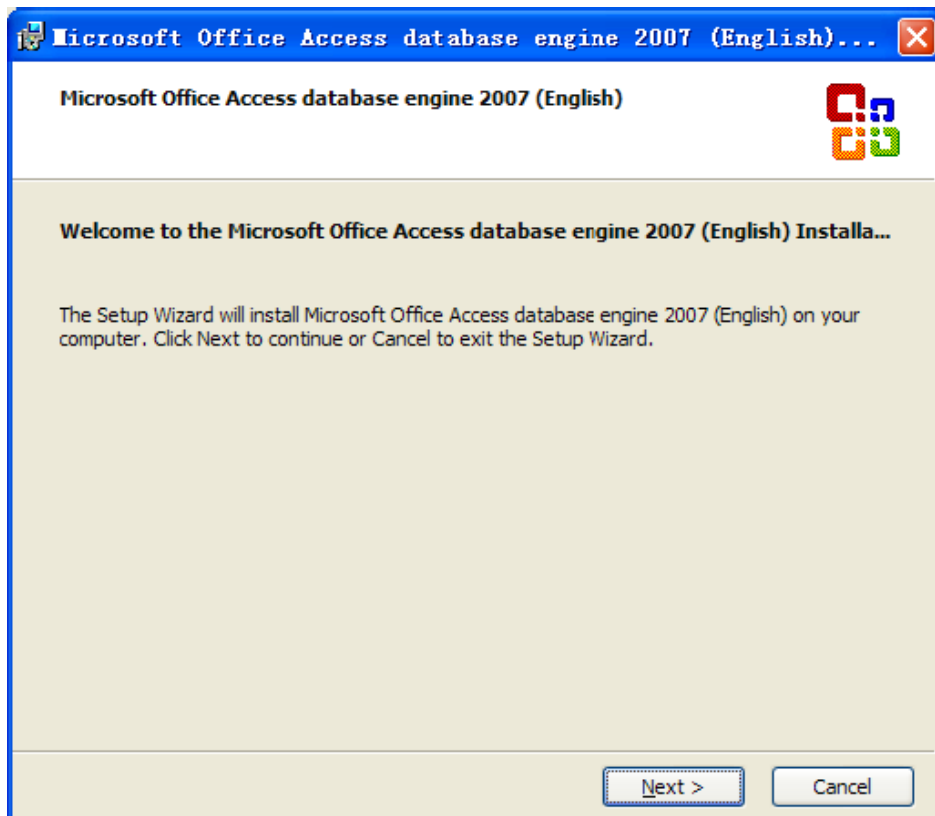

- Tick "I accept the terms in the License Agreement" and then click "Next"



- Click "Browse" to change the default folder to the expected one, or click "Install" to continue the installation.

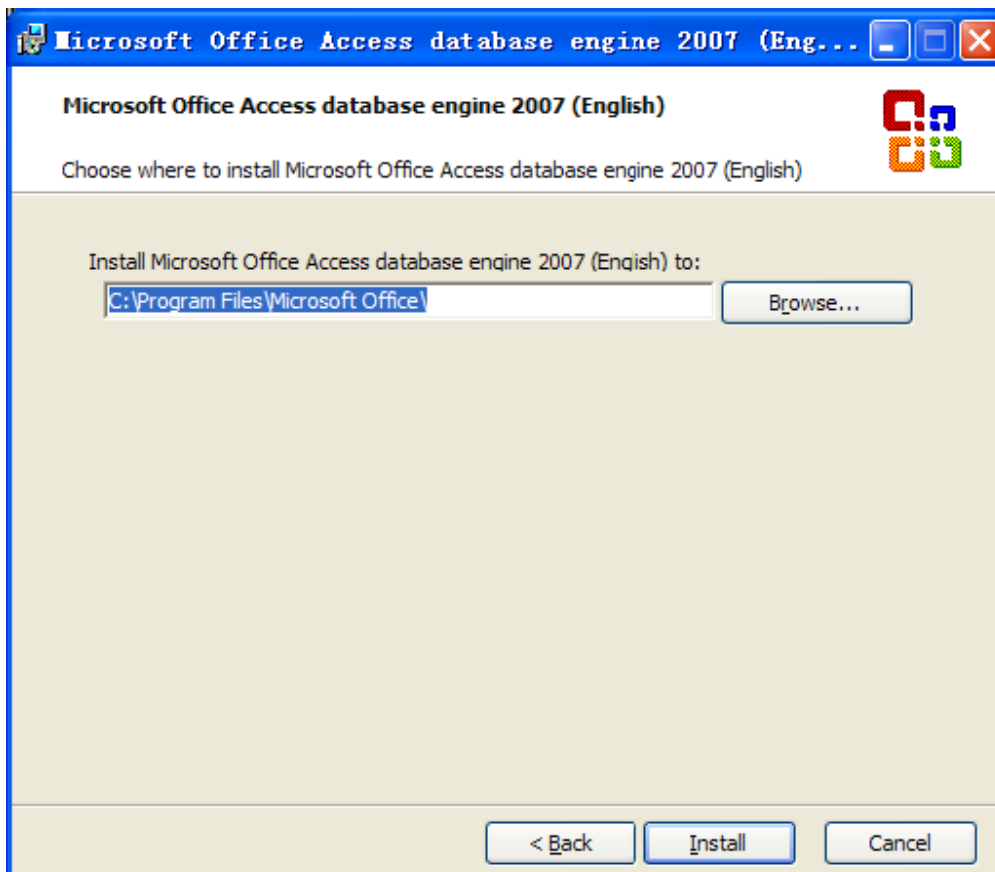

- Installation is in progress.

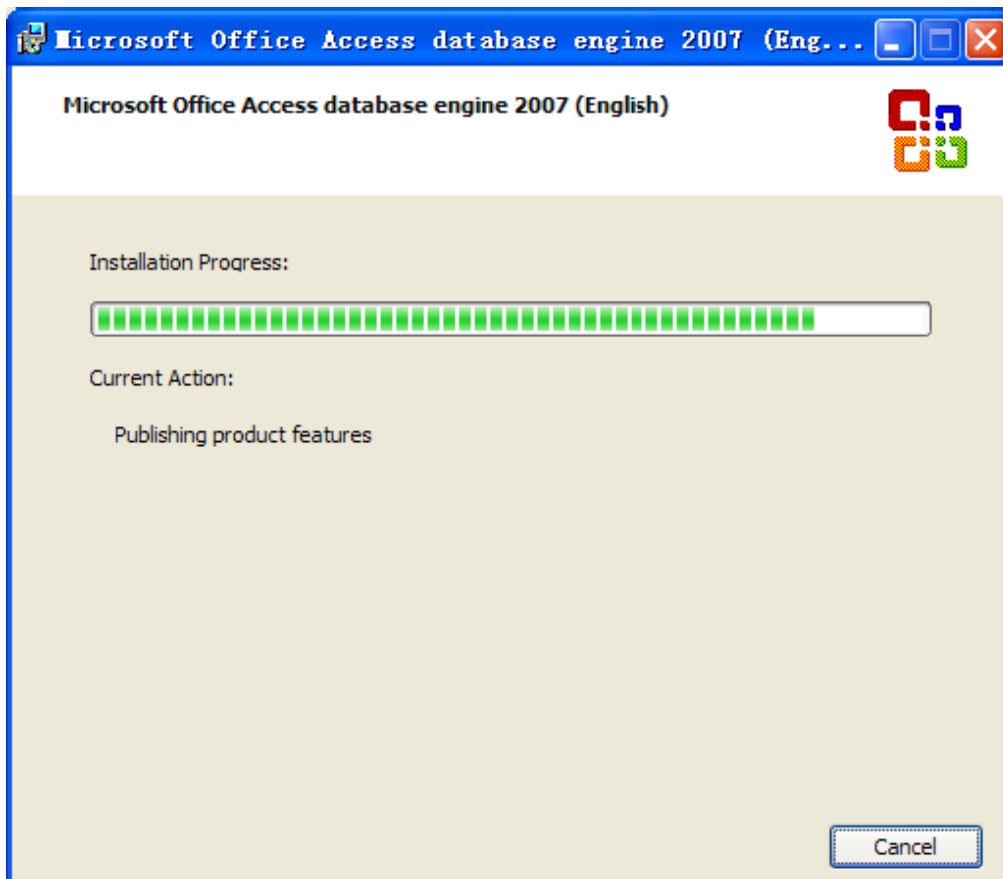

- Click “Ok” to complete the installation.



(3) Install Gree Debugger

- Before installing Gree debugger, make sure that your computer is installed with .Net Framework 4.0 or versions above. Then click “Install Gree Debugger”.



- Click “Next”.

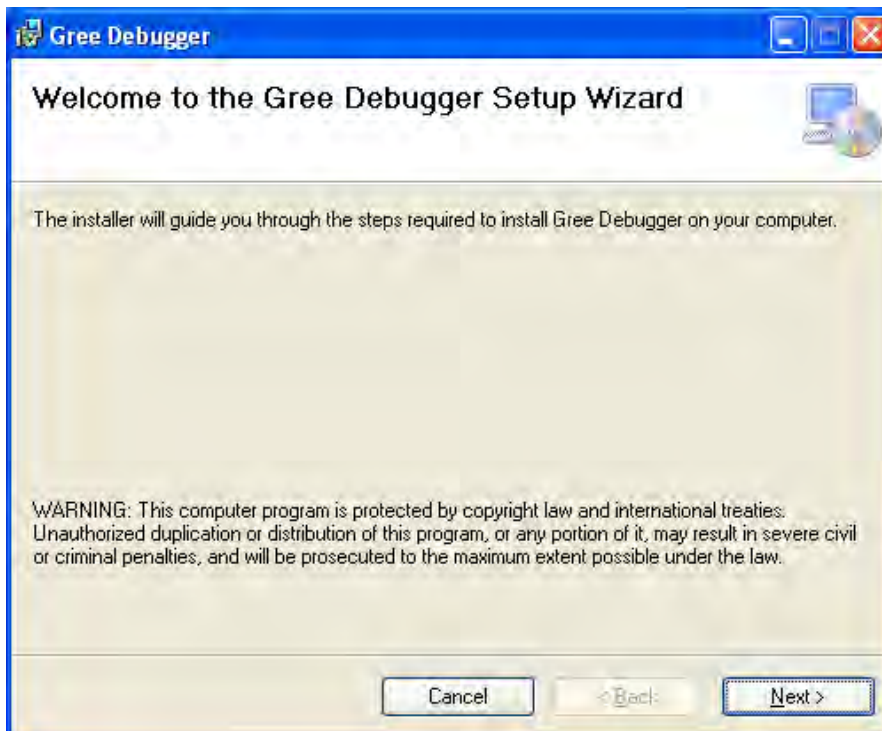

- Click “Browse” to select installation folder. If no change is needed for the folder, click “Next” to continue the installation.

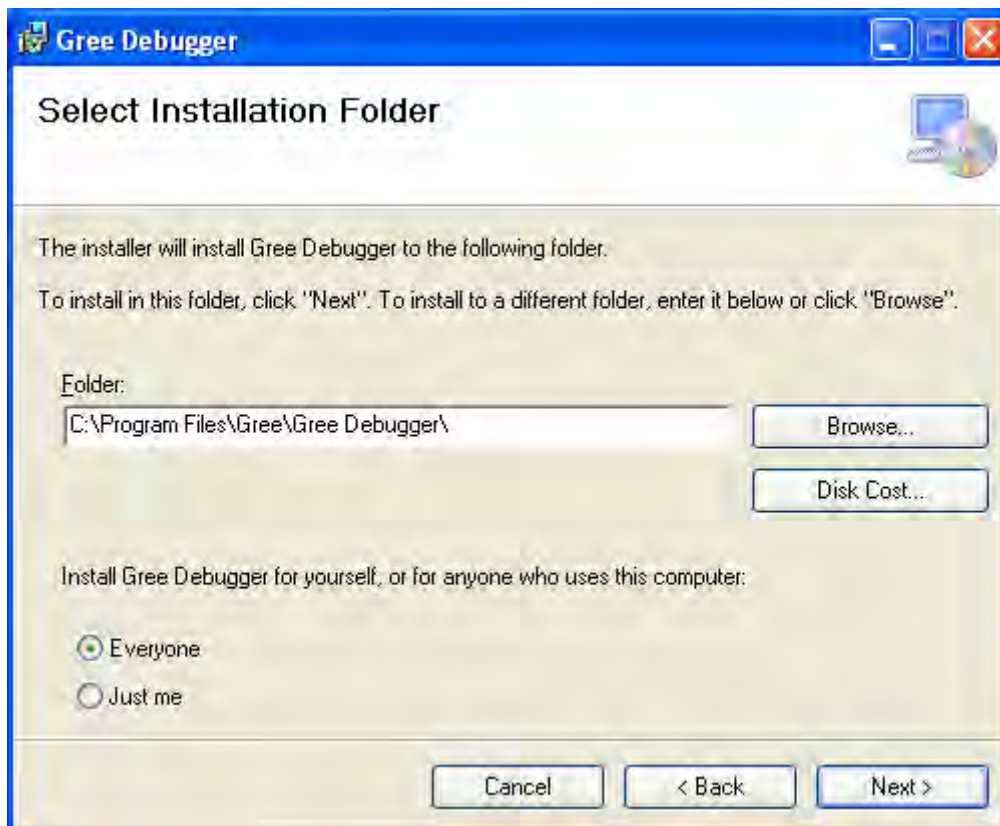

- Click "Next".

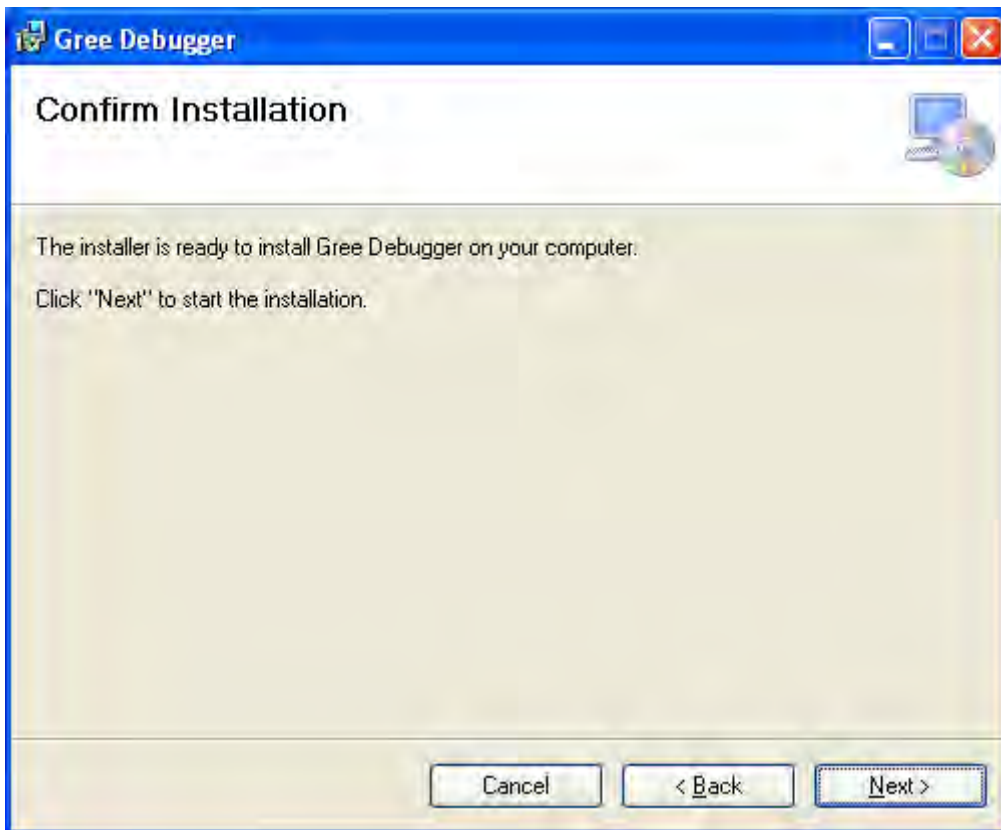

- Installation is in progress.

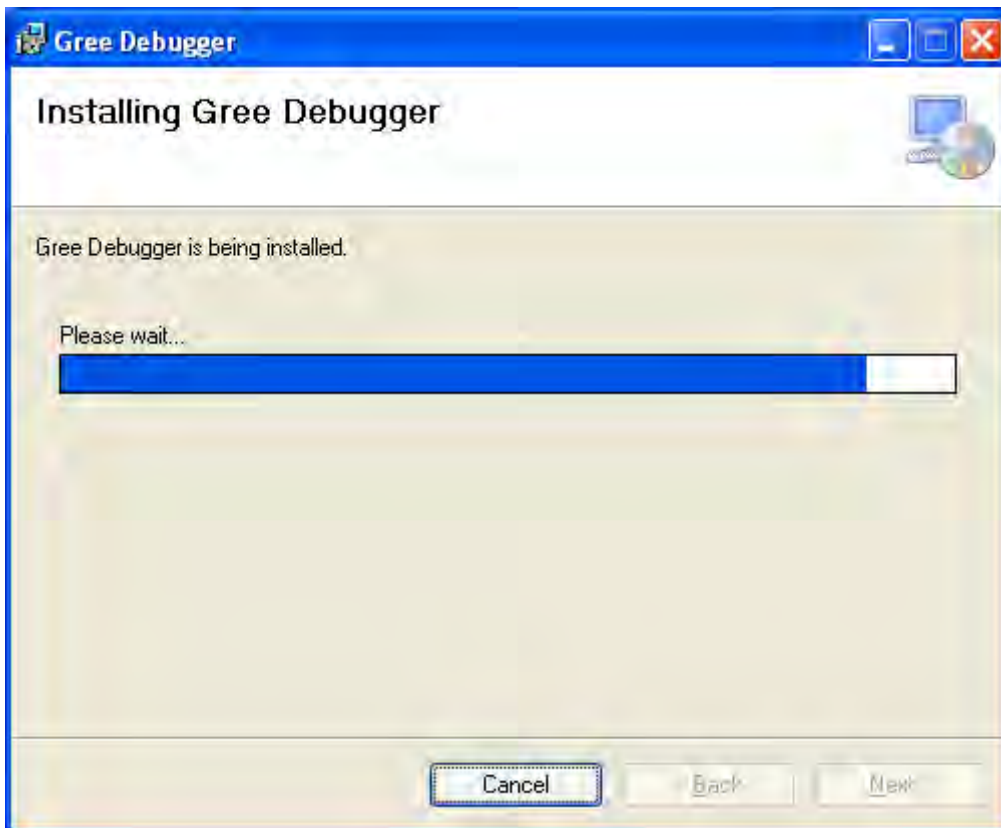

- Click “Close” to complete the installation.

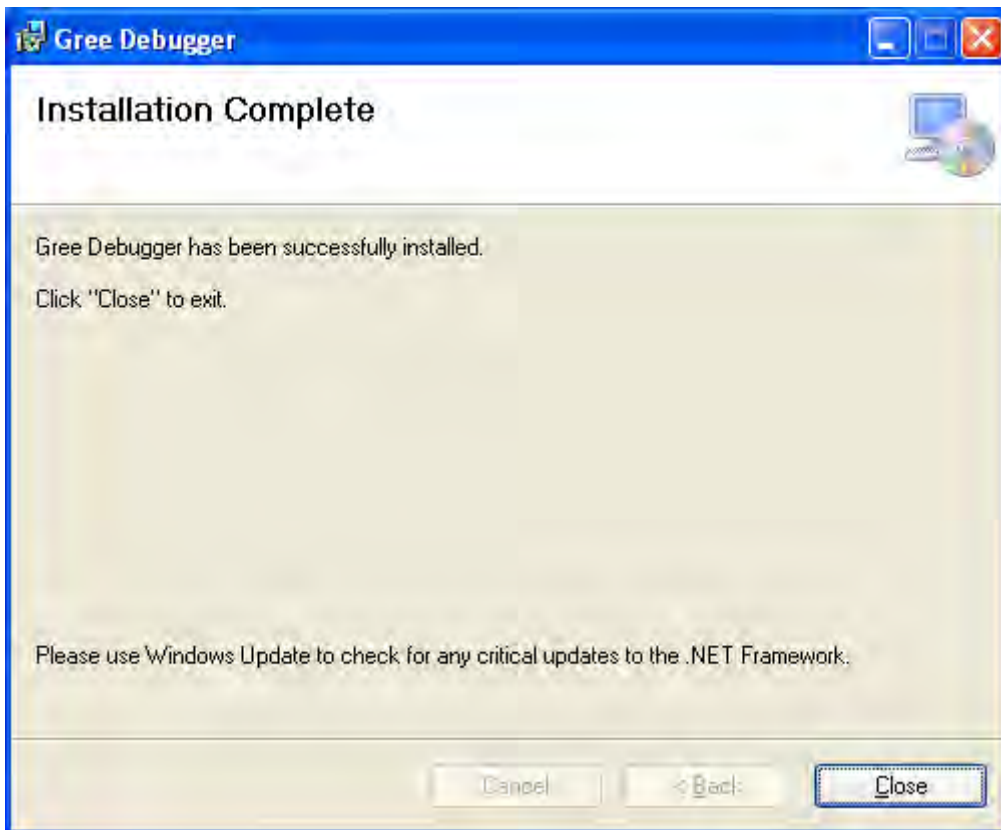

(4) Install USB Converter Driver

- If USB converter driver is already installed in your computer, this part can be skipped. Otherwise, click “Install USB Converter Driver”.



- Then the following installation window will be shown.

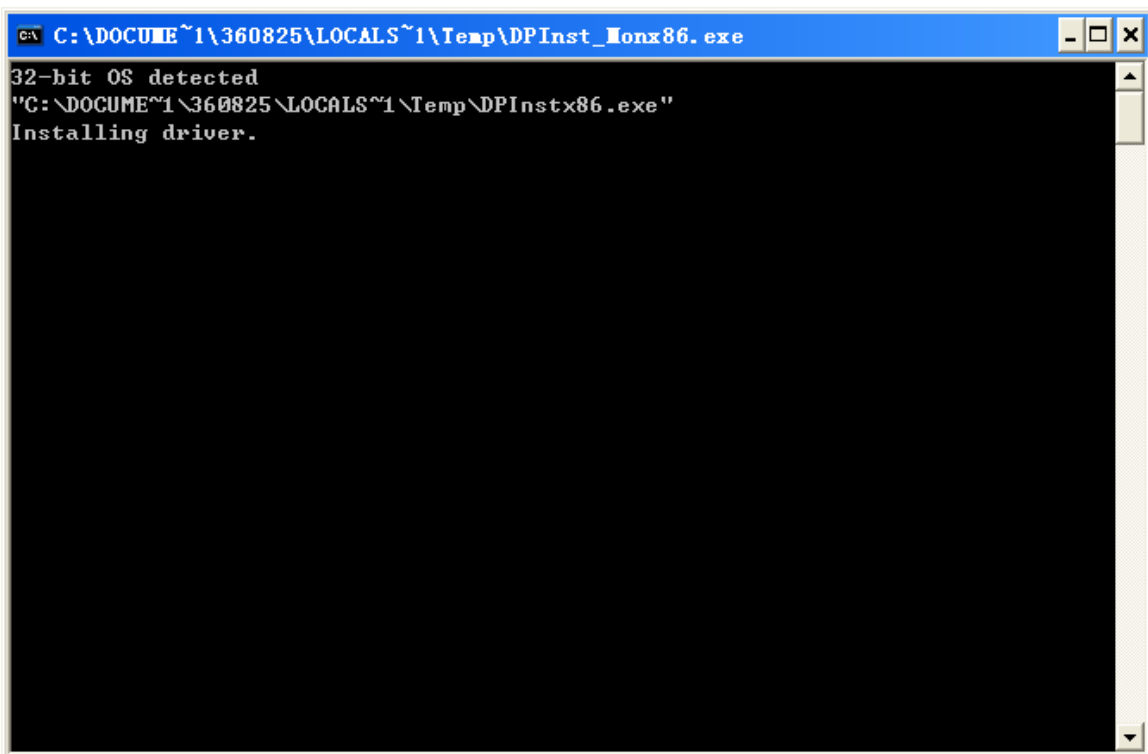

```
C:\> C:\DOCUMENT~1\360825\LOCALS~1\Temp\DPInst_Monx86.exe
32-bit OS detected
"C:\DOCUMENT~1\360825\LOCALS~1\Temp\DPInstx86.exe"
Installing driver.
```

- This window will exit after installation is finished.

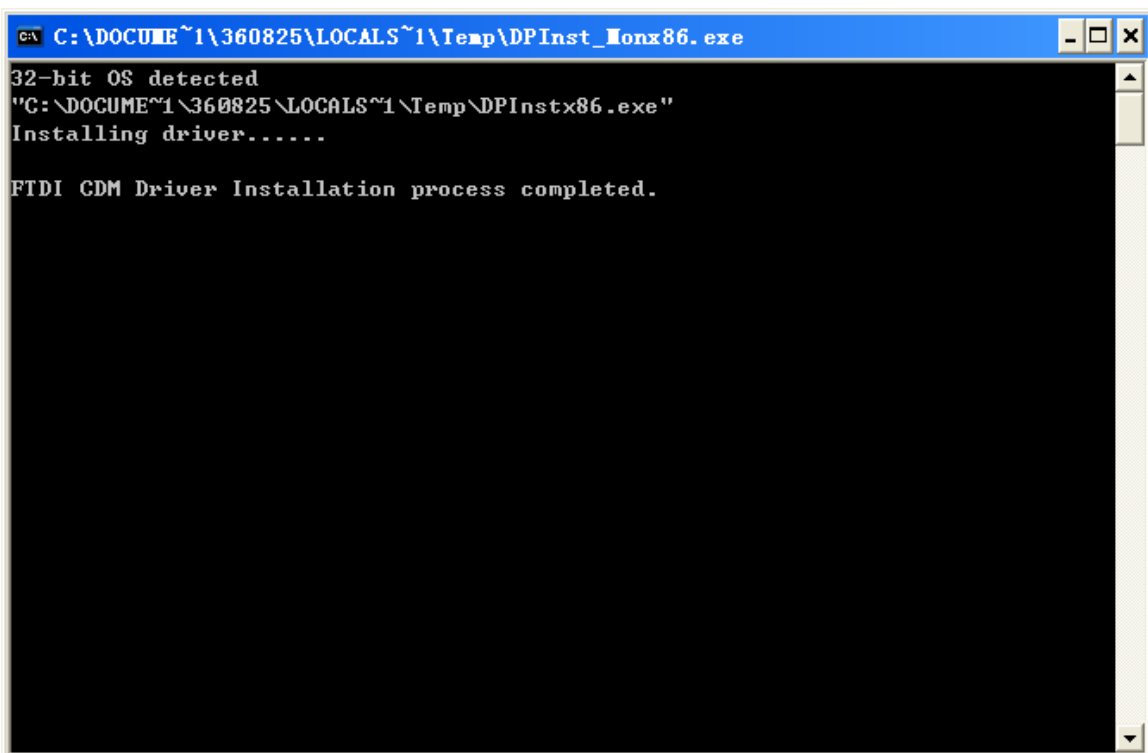

```
C:\> C:\DOCUMENT~1\360825\LOCALS~1\Temp\DPInst_Monx86.exe
32-bit OS detected
"C:\DOCUMENT~1\360825\LOCALS~1\Temp\DPInstx86.exe"
Installing driver.....

FTDI CDM Driver Installation process completed.
```

(5) Install Gree USB Data Converter

- If converter baud rate is needed to be set, then converter configuring software must be installed.
Click “Install Gree USB Data Converter”.



- Then select the setup language. You can choose Chinese “simplified”, Chinese “traditional” or English. Then click “OK”.

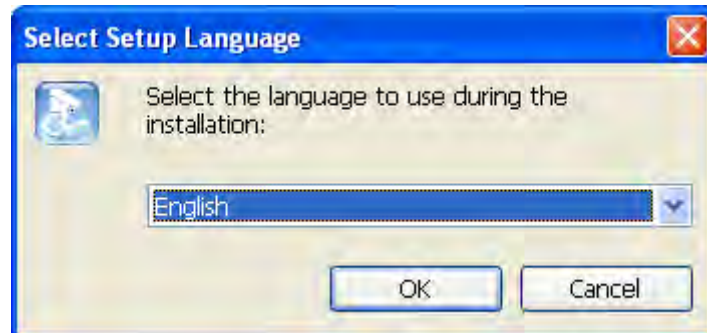

- Click “Next”.

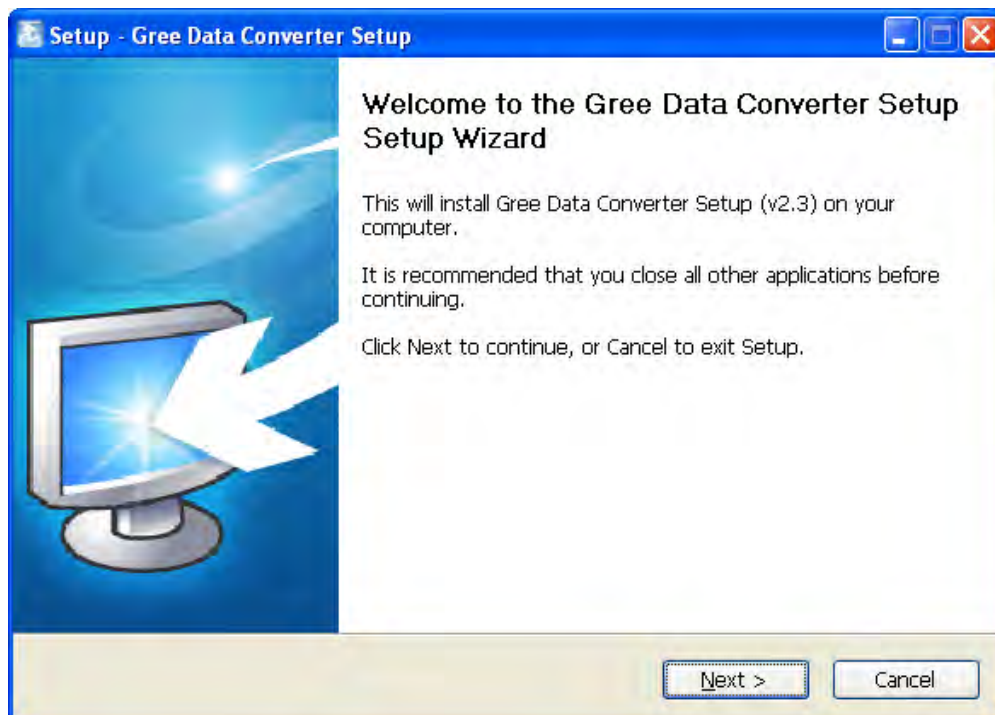

- Click "I accept the agreement". Then click "Next" to continue installation.

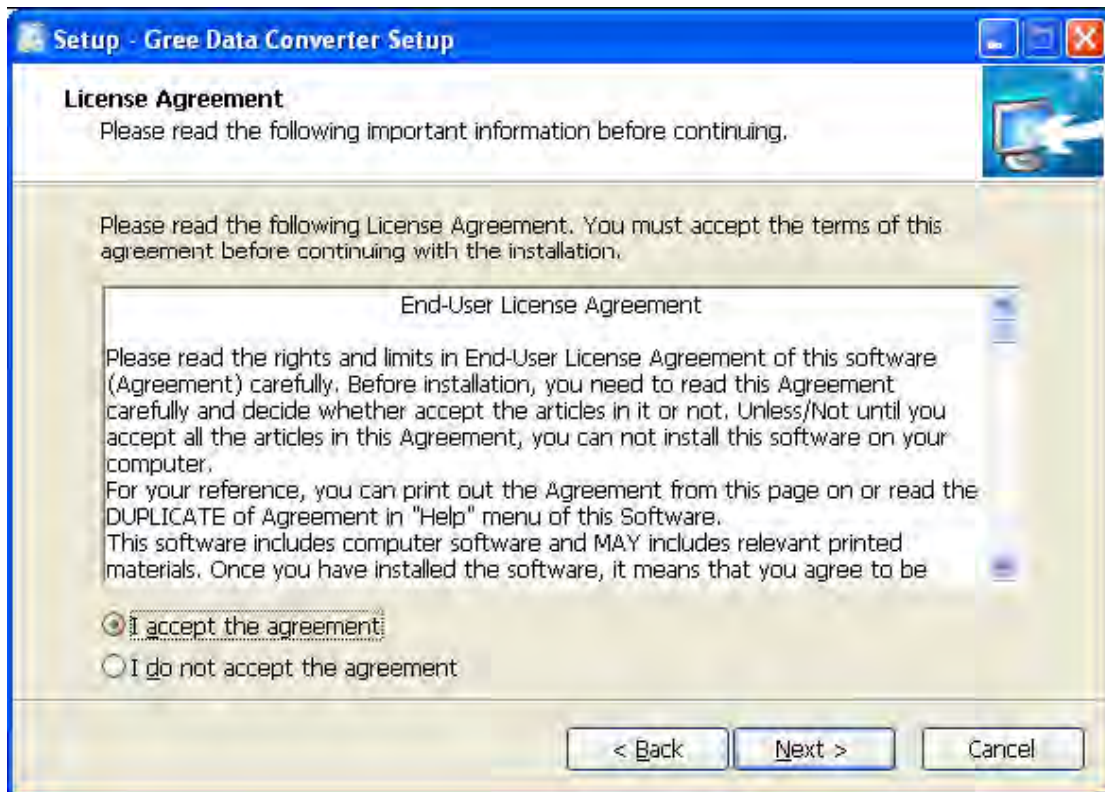

- Click "Browse" to select your expected installation folder. Click "Next" to continue.

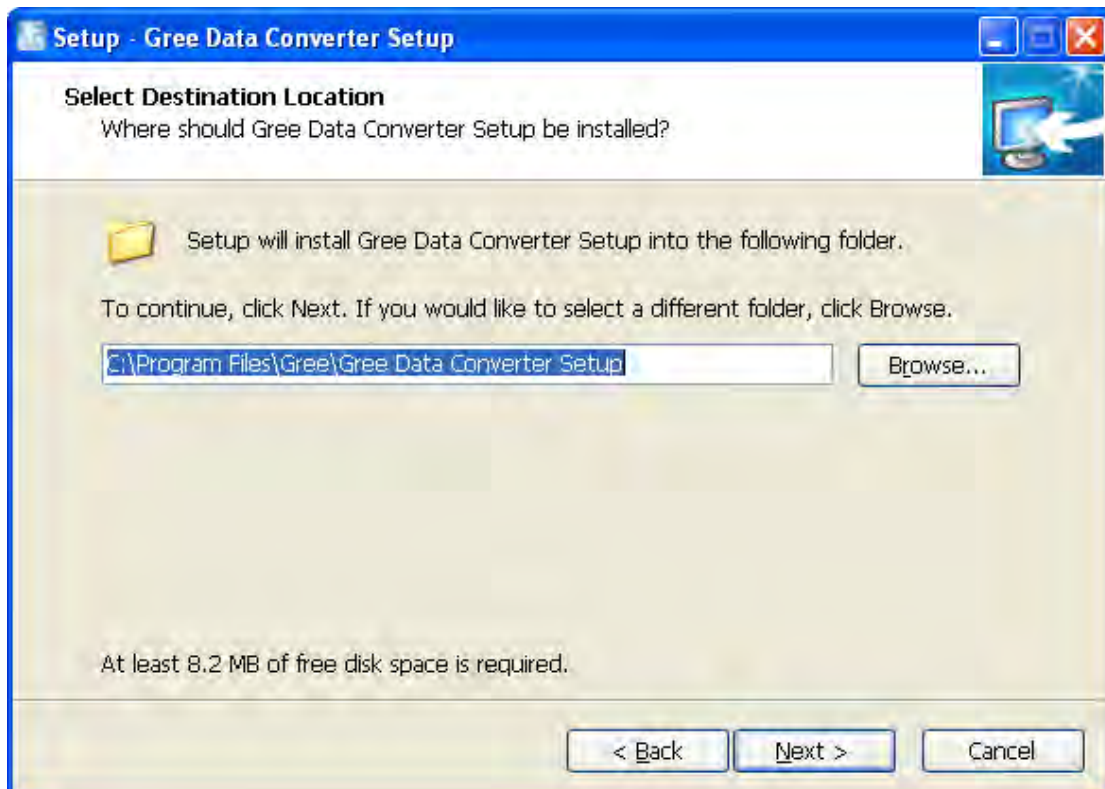

- Click “Browse” to change folder. Click “Next” to continue.

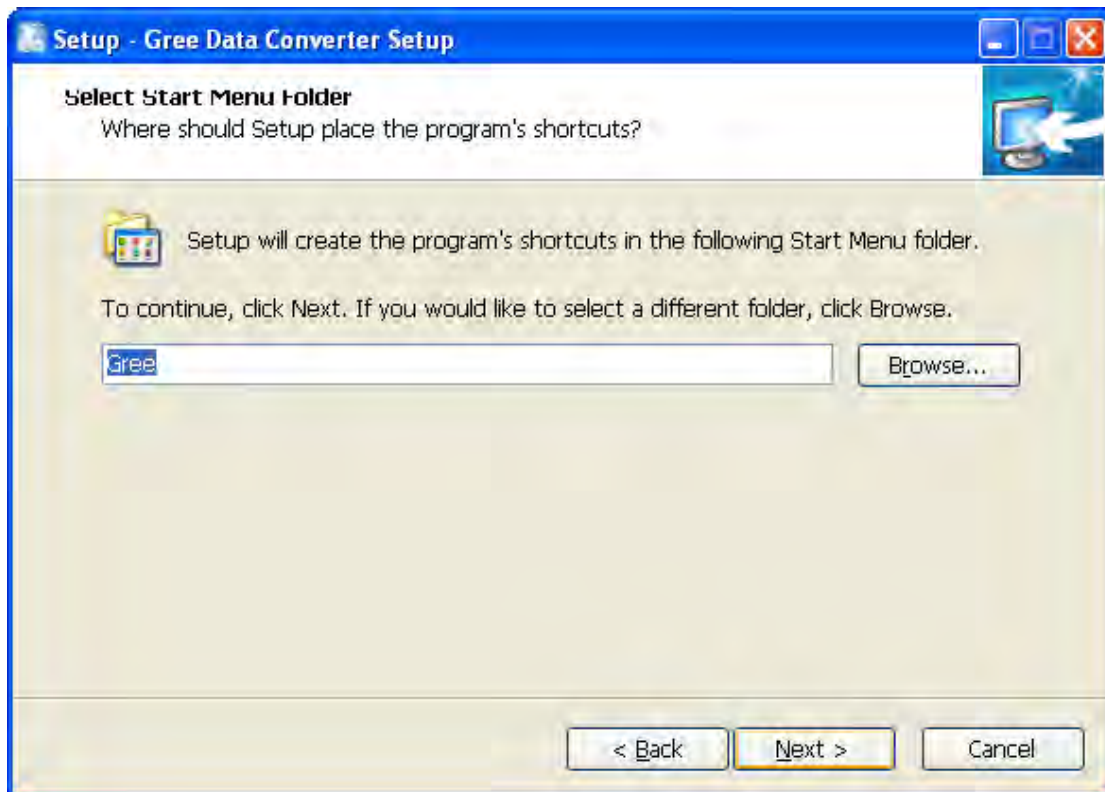

- If you want to create a desktop shortcut, tick “Create a desktop icon”. Then click “Next” to continue.

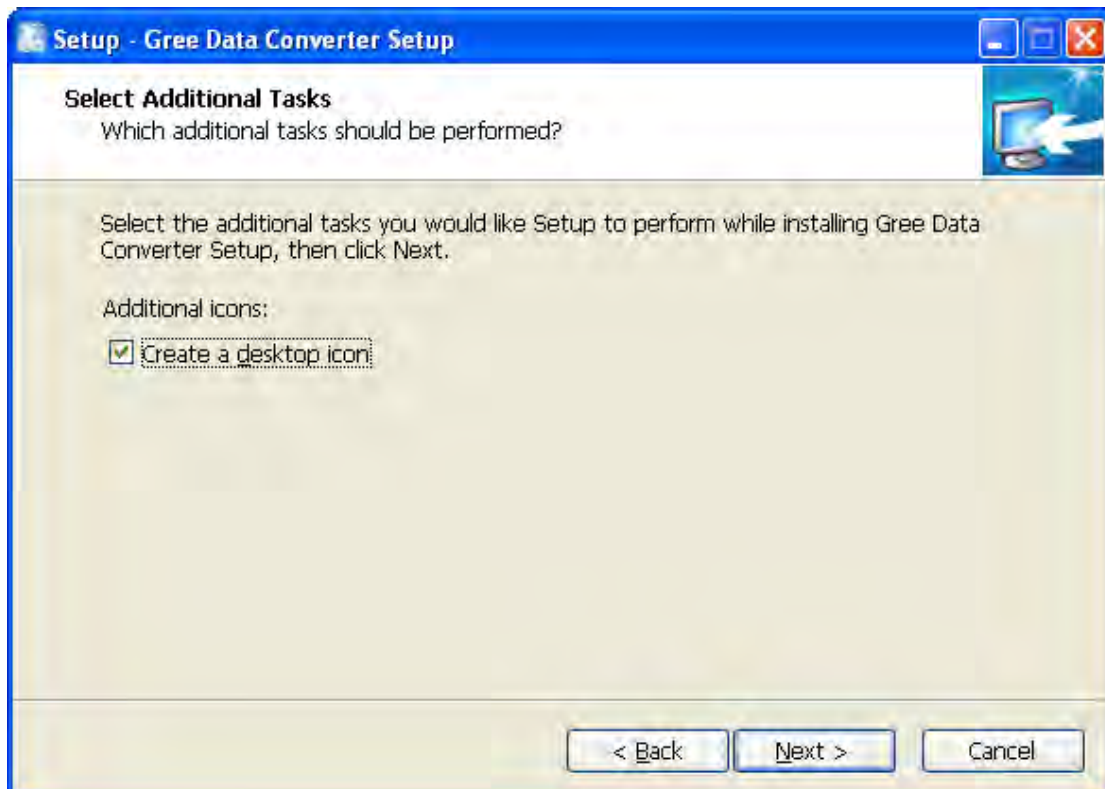

- Destination location, folder and additional task will be shown in the next step. If you need to change any of it, please click “Back”. If not, click “Install” to start installation.

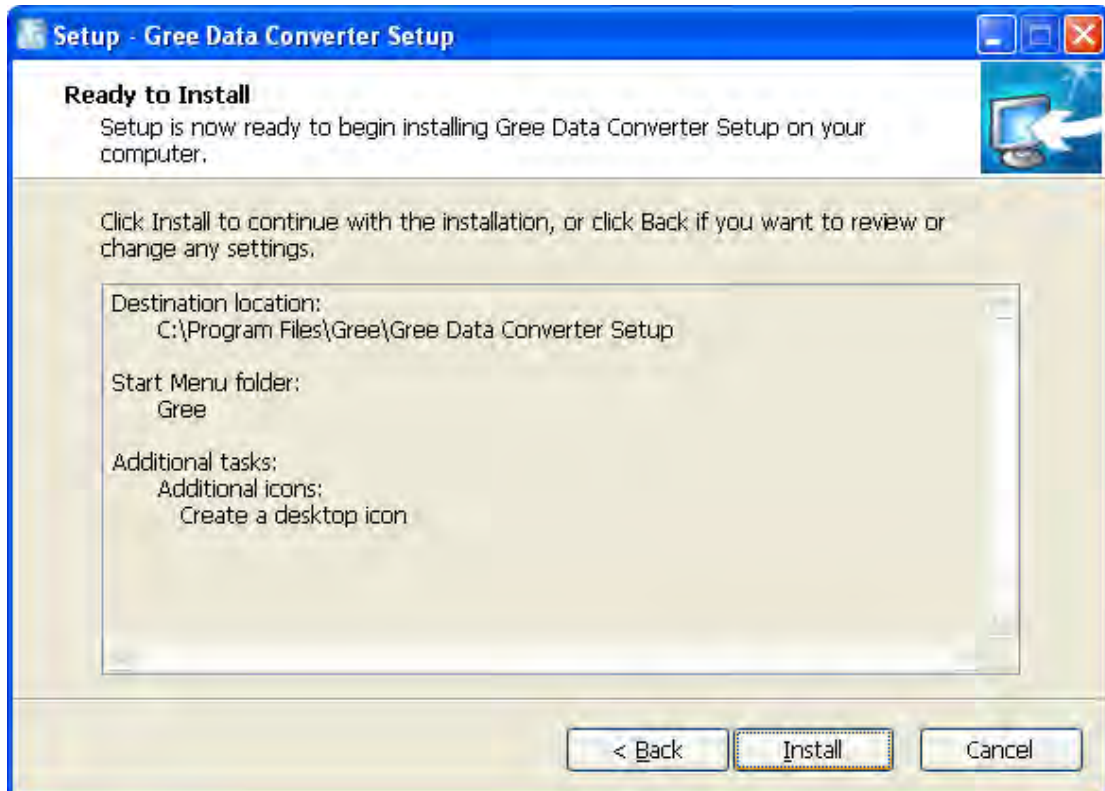

- Installation is in progress.

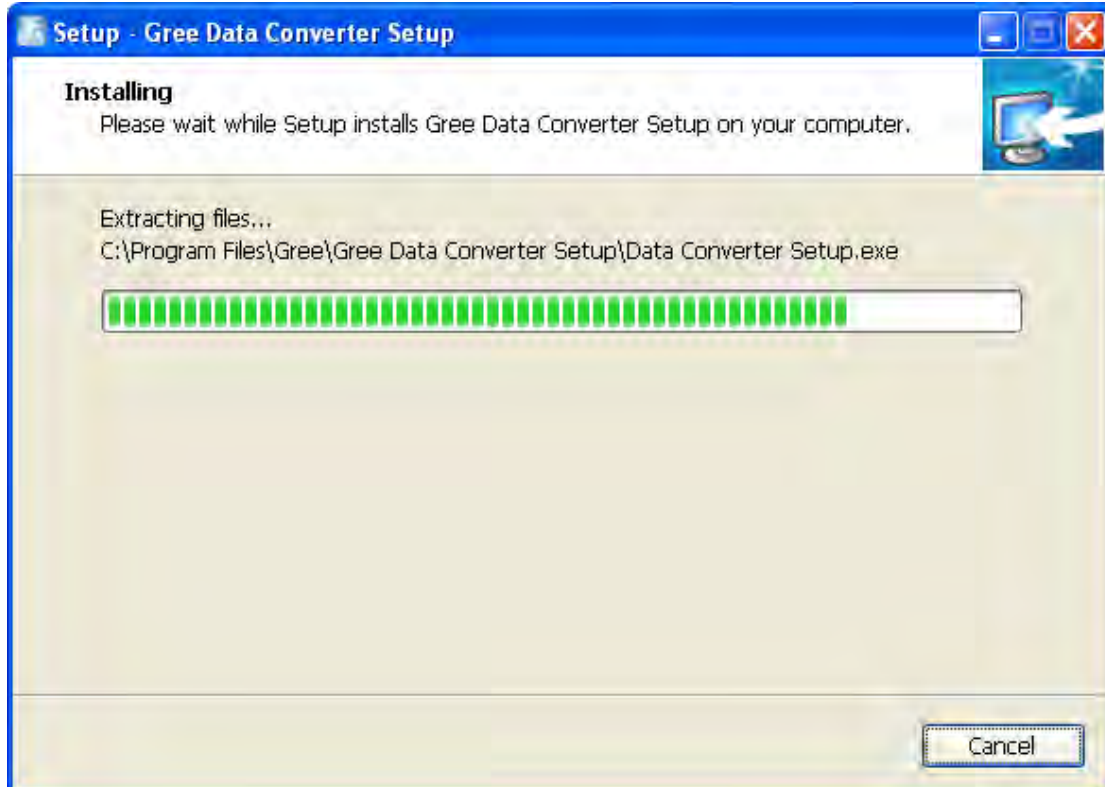

- Click “Finish” to complete the installation.

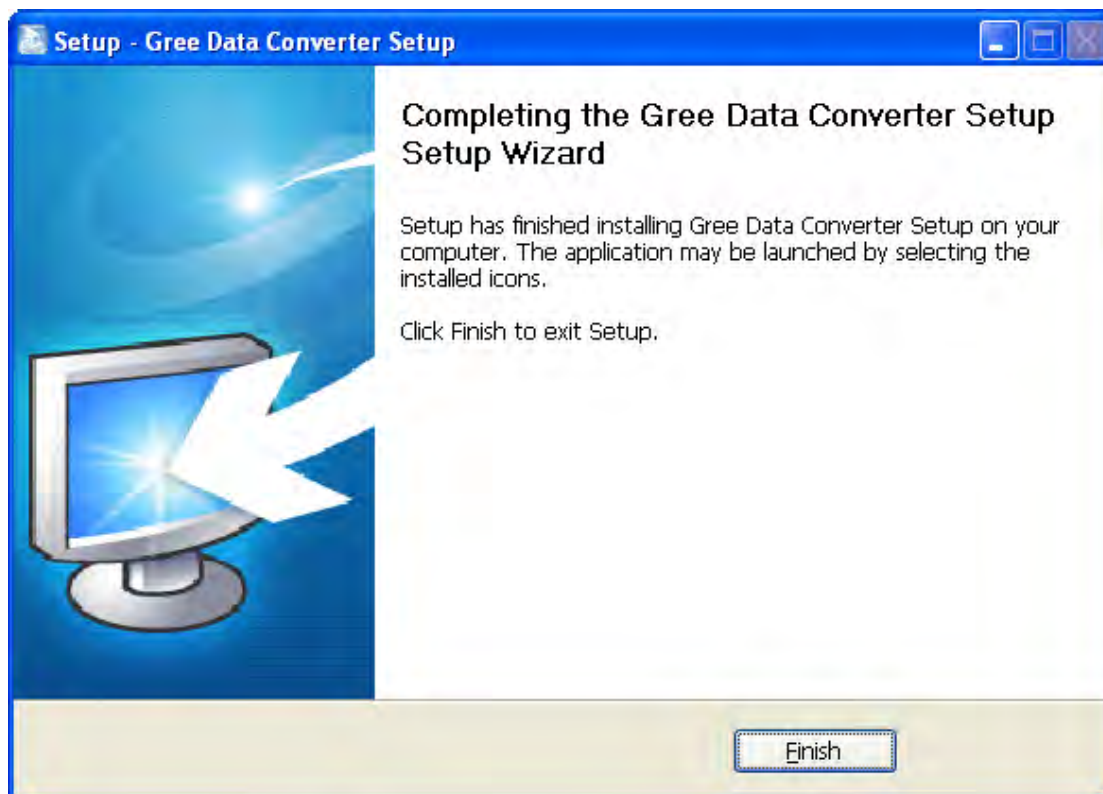

3.4.2 Data monitoring

- Start up Gree Debugger.



- On the original interface, user can select language and units system. Click “OK” to confirm the defaulted language and units system and start up the software.

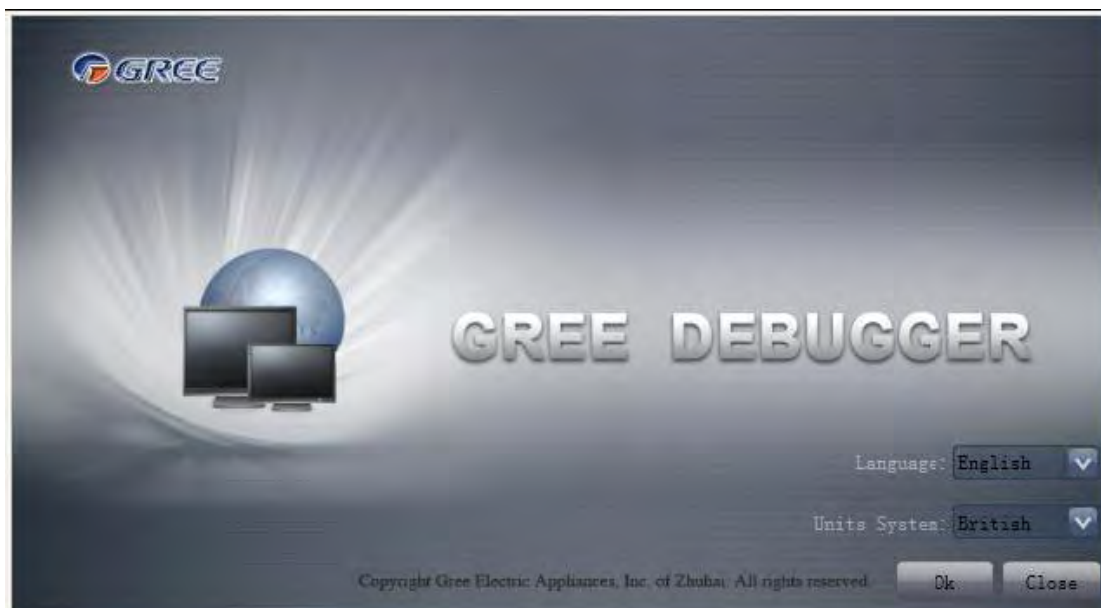

- Select language.

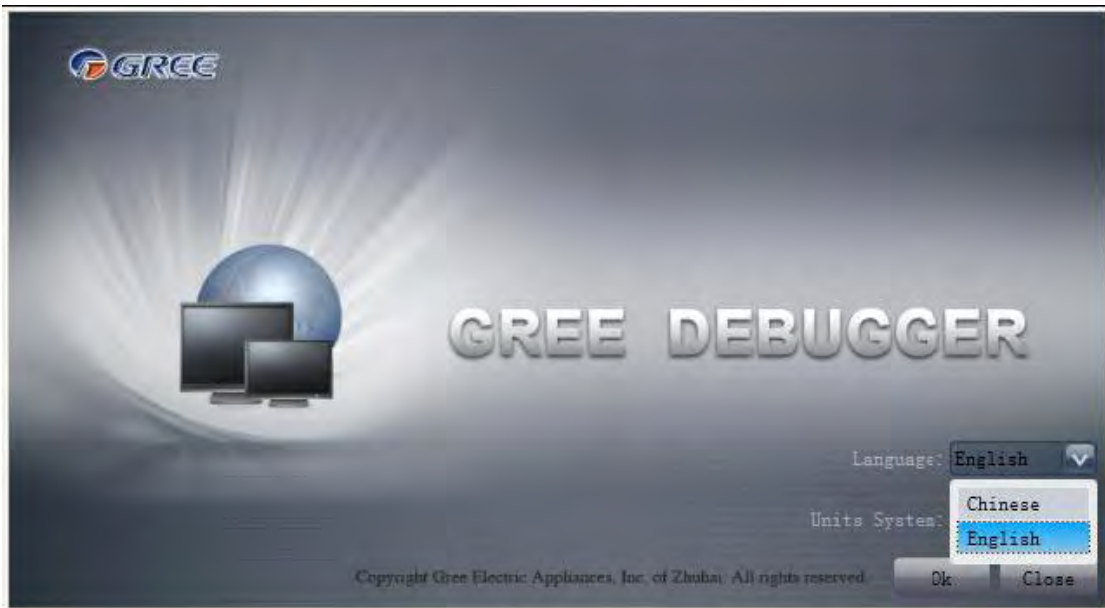

- Select system of units.

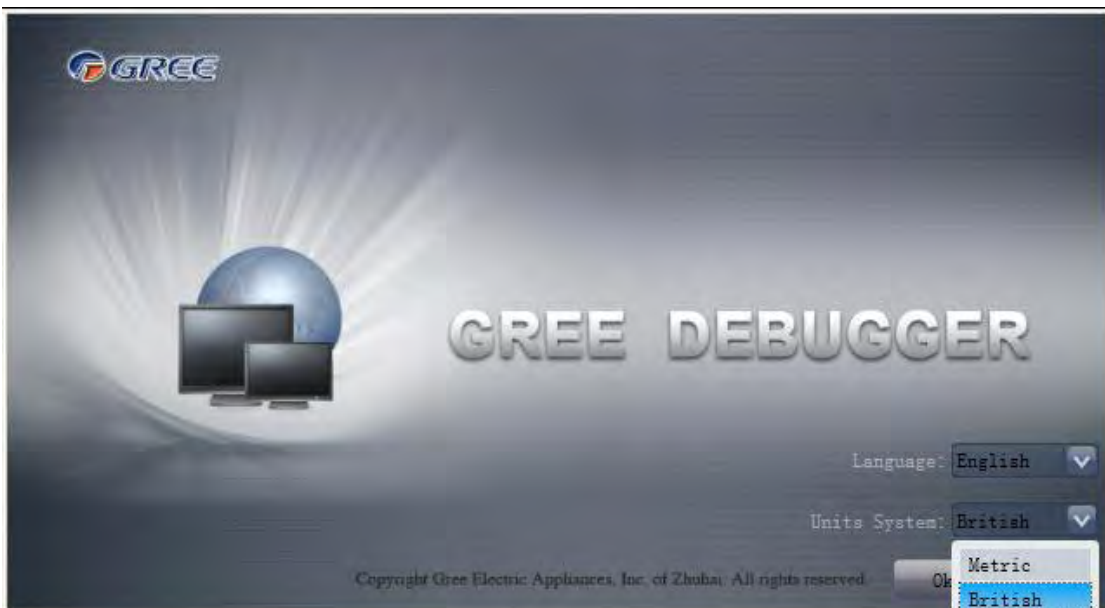

- If units you want to monitor are already connected, and able to communicate normally, with correct COM and protocol, then you may click “Connect” to enter the interface of numbers. Otherwise, connect in accordance with the connection diagram shown below.

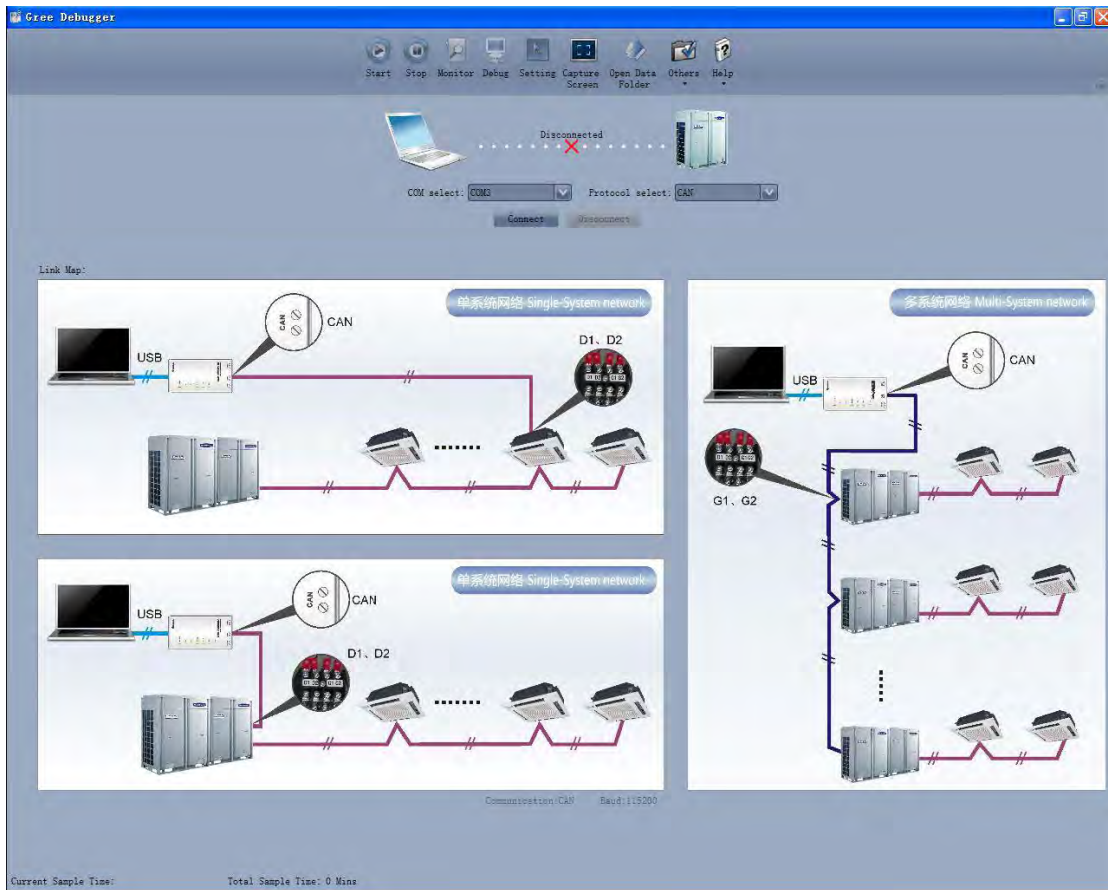

- COM selection: the serial port in your computer can be detected automatically. You just need to select your desired serial port.

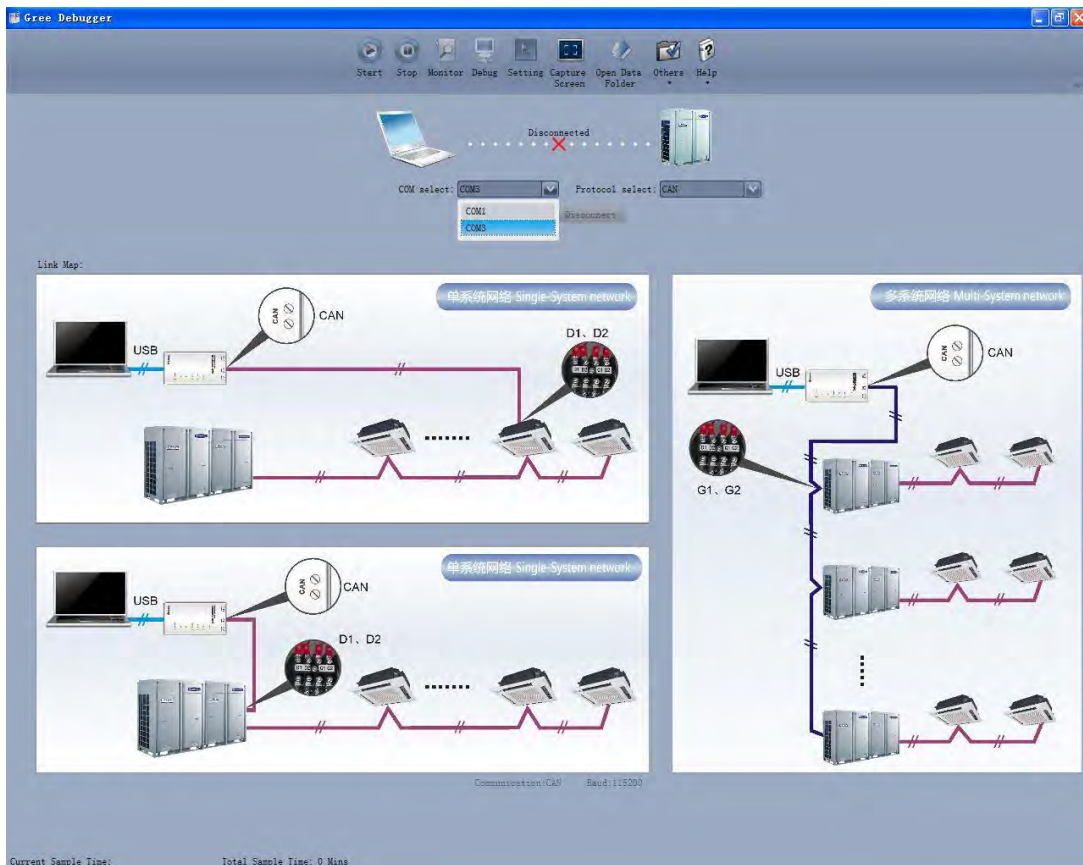

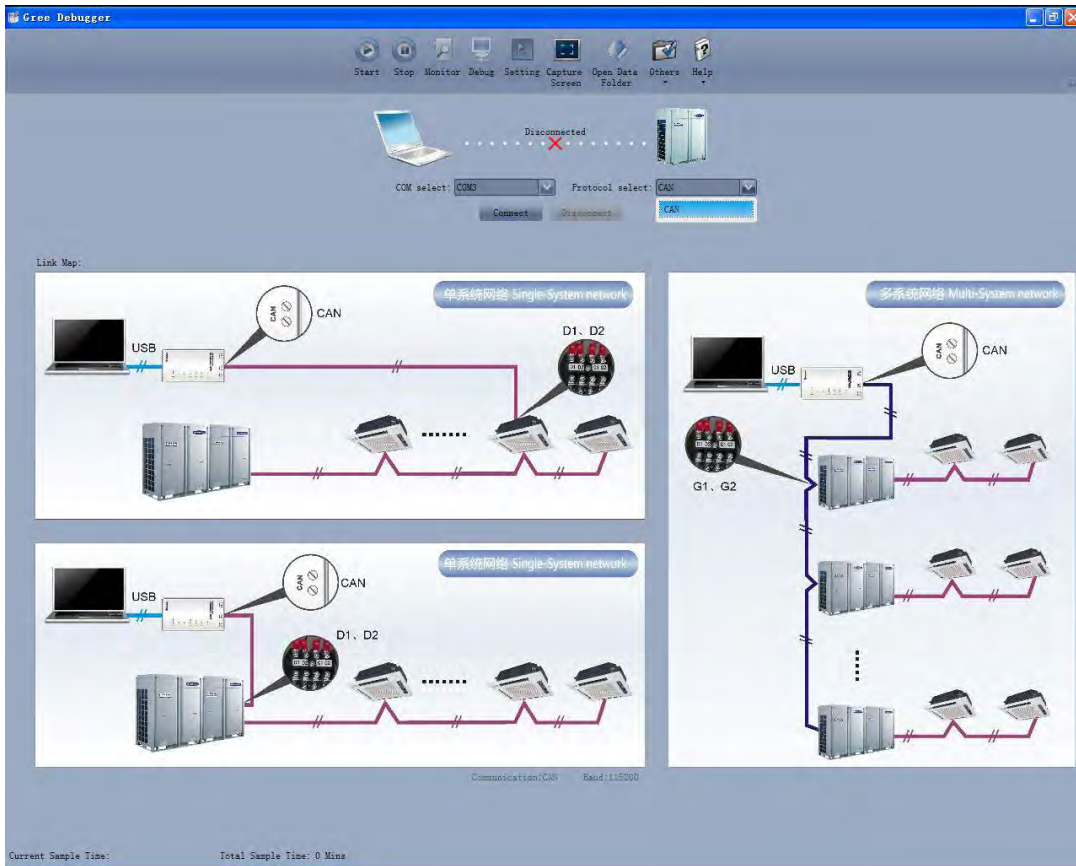

- Protocol selection: This is to select the communication method of your units. Currently, CAN is applicable to the units.

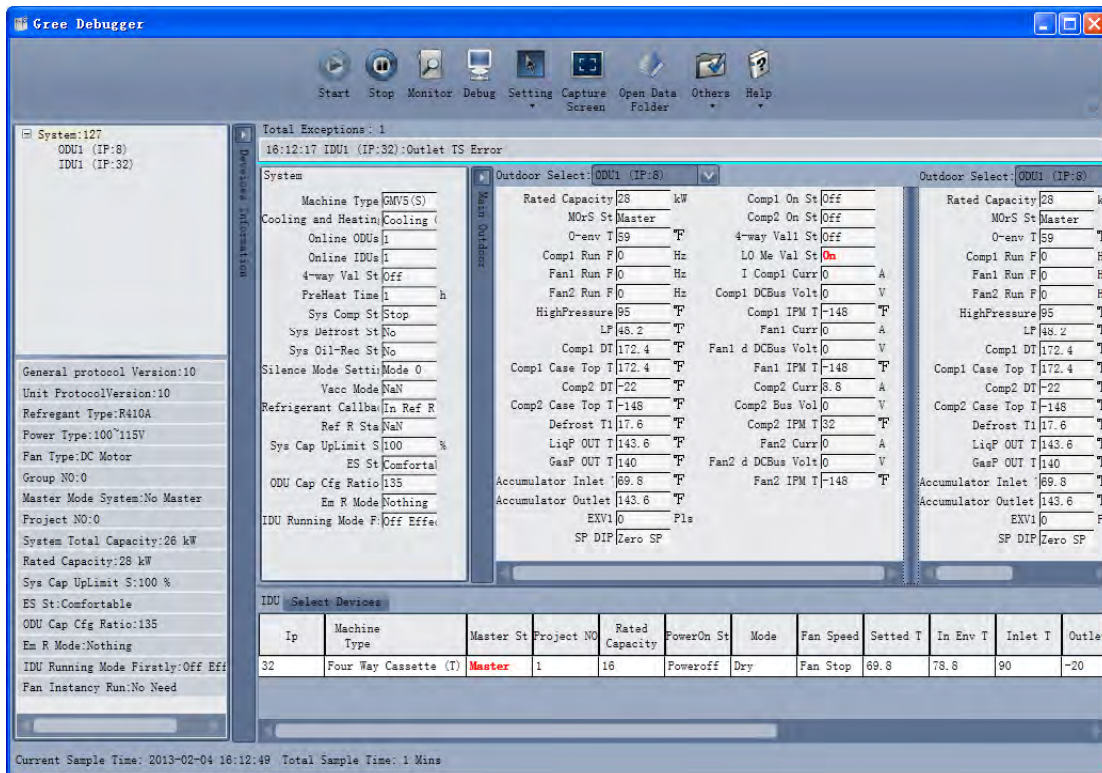
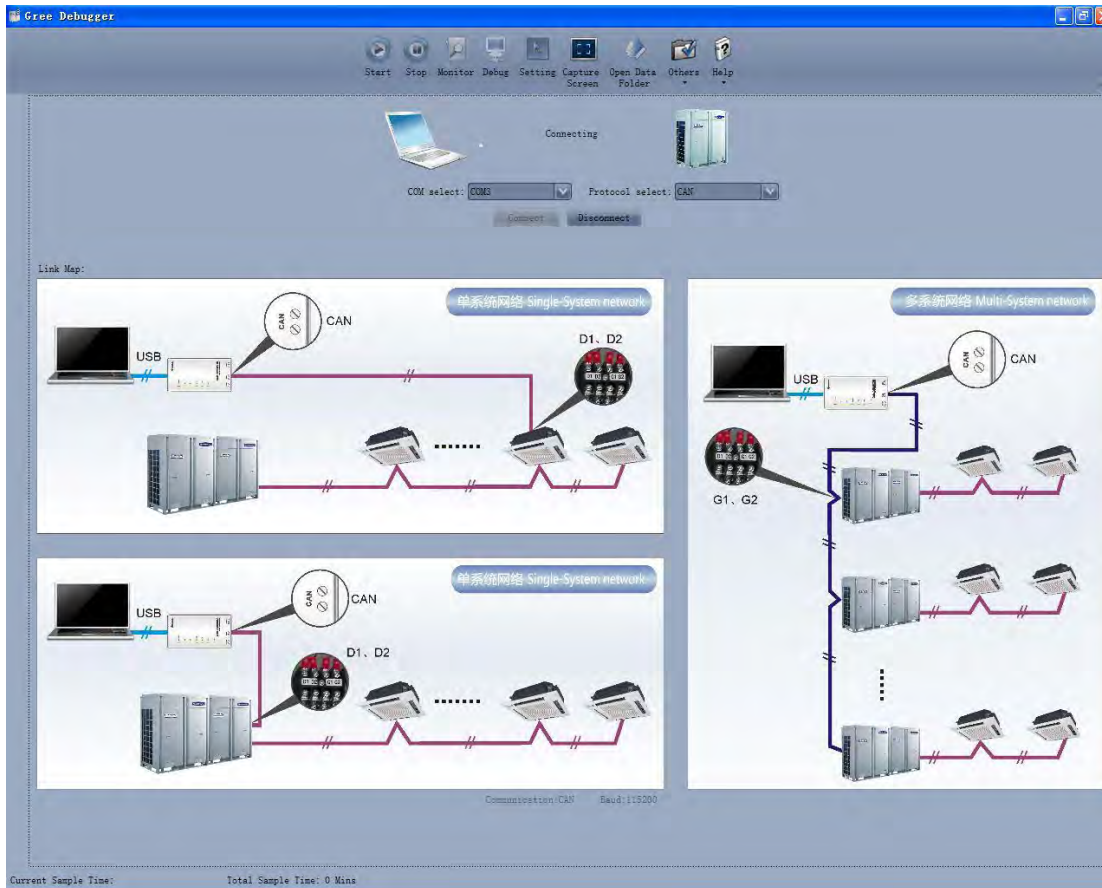

- After the selection, click “Connect”. If units can communicate normally with computer, then the interface of numbers will be shown soon. Otherwise, “Connecting” will be shown.



- There are several display zones on this interface. You can hide devices information and system information by clicking devices information icon  and system icon . Display zones of indoor unit information and errors can be dragged up and down at the dividing lines. As to the display zone of outdoor modules information, it can show information of only one module and hide information of others (two modules are defaulted to be shown). Menu bar can be hidden by clicking icon . Status bar shows the current time and period for data collection.

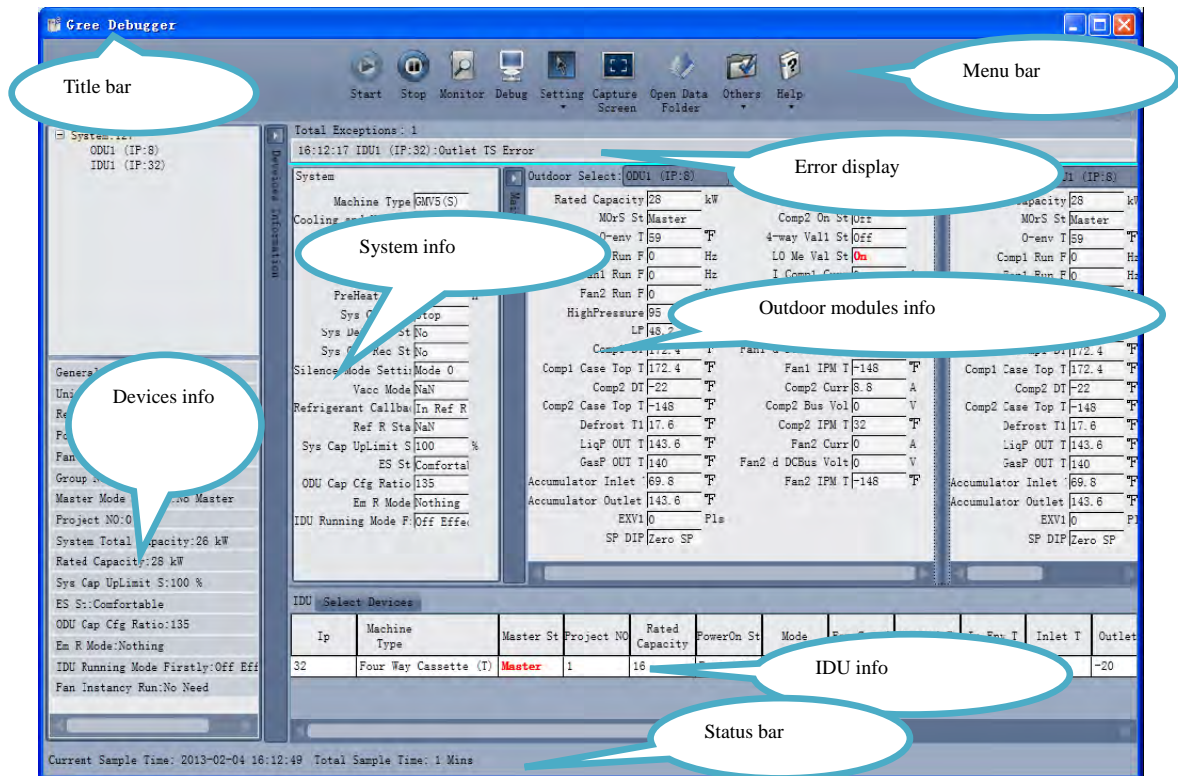



- On the display zone of devices information, you may click to select and view units that need monitoring.



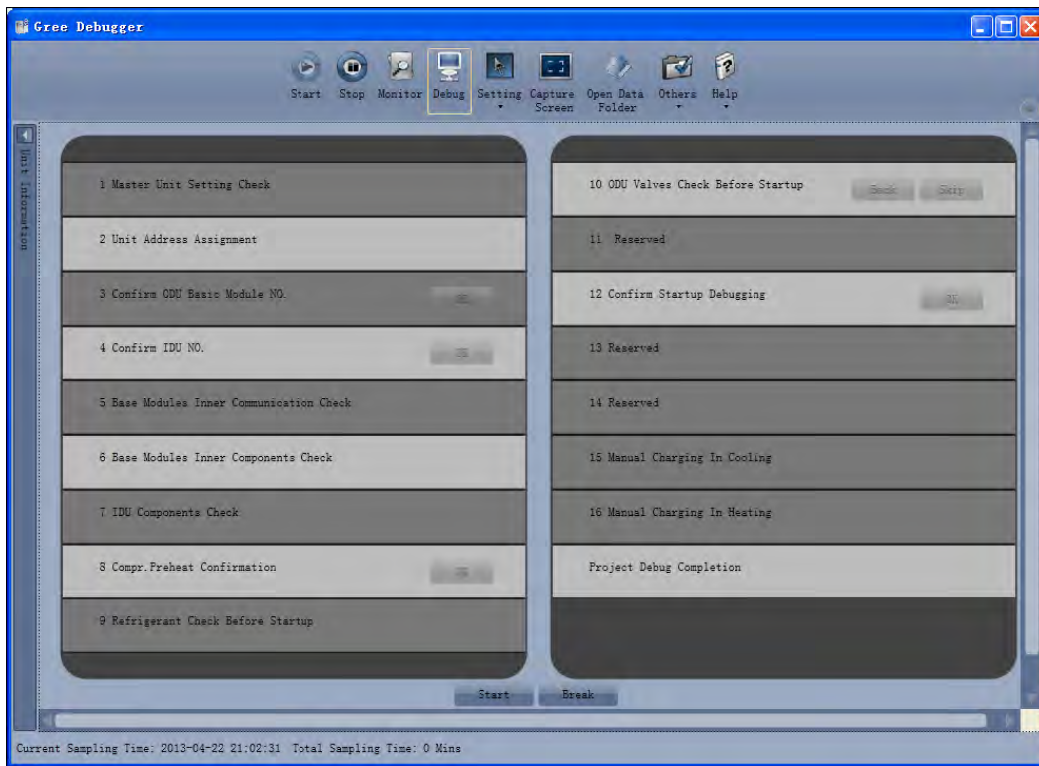

3.4.3 Project debugging

- Click icon of “Debug” on the menu bar and the interface will be switched to project debugging, where auto debugging will be started from up to down and from left to right. Note: Debugging function is only applicable to a single-system network.



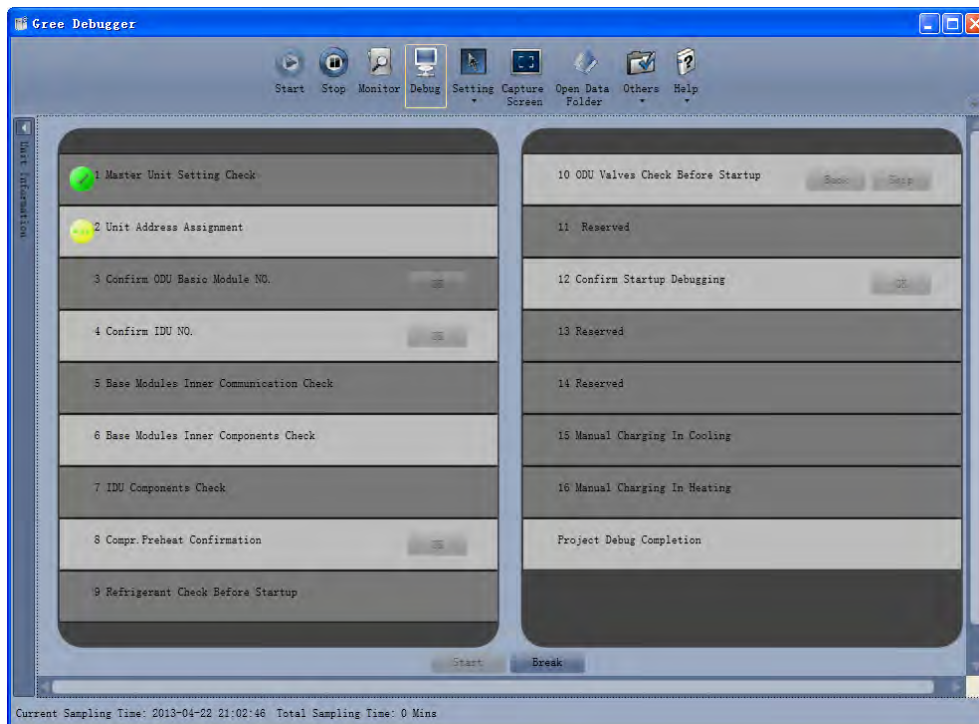

- Click “Start” to enable the debugging function. Then debugging will be started up automatically.  indicates that debugging is in progress while  indicates debugging is completed.

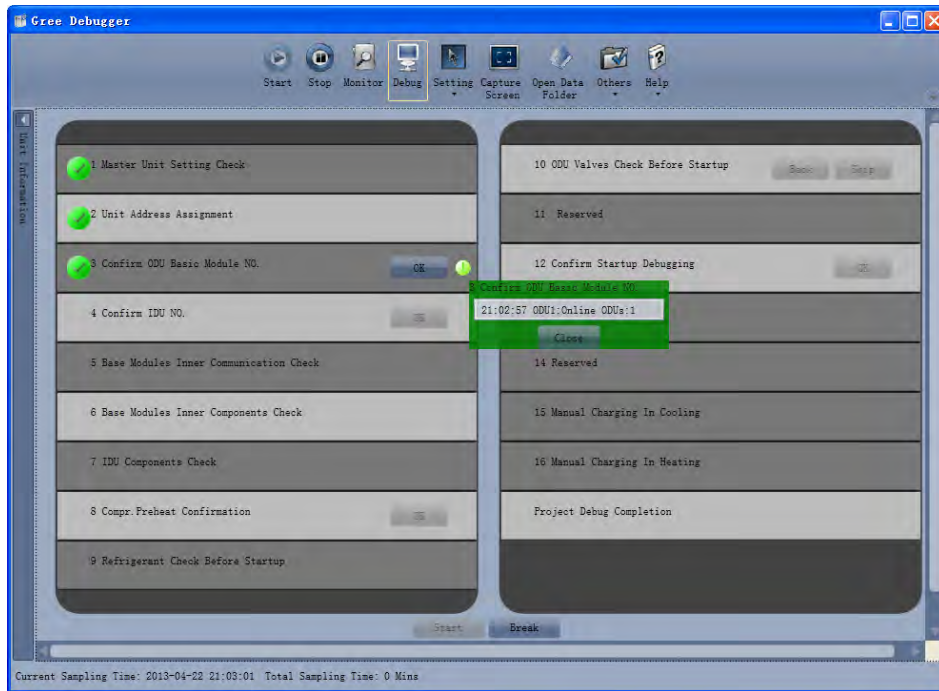

- If “OK” button is displayed, it means user needs to judge whether to continue debugging or not. Click icon  and relevant information will be shown for your reference. Click “Close” to close the pop-up (For No.3 Confirm ODU Basic Module NO. and No.4 Confirm IDU NO., the current number of units under debugging will be displayed. See the following marked with circle. For No.8 Compr. Preheat Confirmation, the preheat time will be displayed. See the following marked with circle).



- Icon  indicates that there is problem found during debugging. Debugging will not be completed unless problem is solved (after problem is solved, step without “OK” button will switch to the next step automatically, otherwise user needs to click “OK” to continue). Click icon  and relevant information detected in this step will be displayed for your reference in order to solve problems. Click “Close” to close the pop-up.

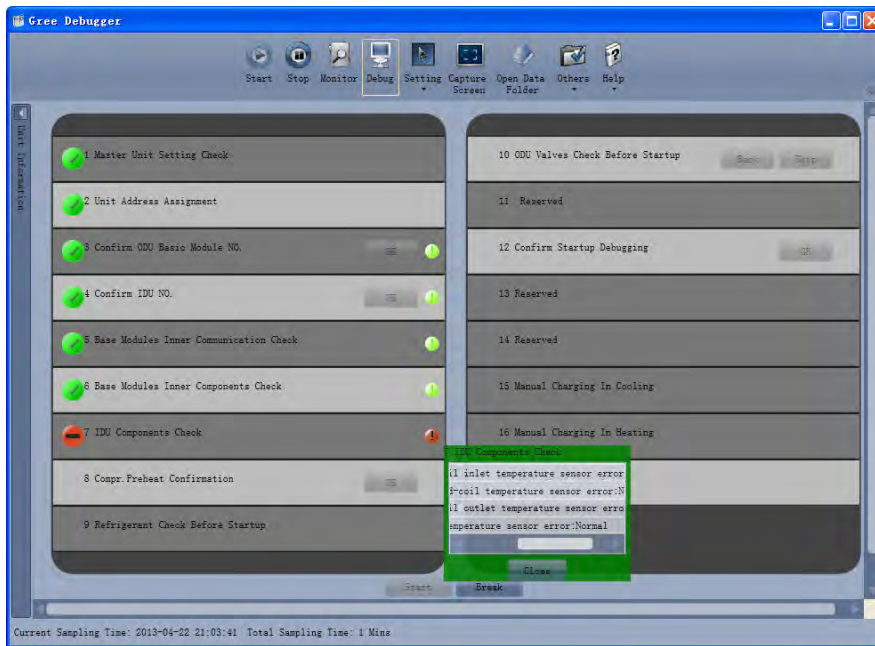

- During debugging, a click on “Break” can stop debugging. Click “Start” to resume debugging and then debugging will be finished step by step. For No.10 ODU Valves Check Before Startup, there are “Back” and “Skip” buttons. If there is error in this step, you can back to step No.9 and click “OK” to restart debugging on step No.10. If the error in step No.10 is U6 error (valve error alarm), you can click “Skip”. In other cases, “Skip” button is null.
- Step 11, 13 and 14 are reserved steps. And step 13, 14, 15 and 16 are steps in parallel (only one of the four will be selected according to actual needs).

3.4.4 Control units

- Click icon of “Setting” on menu bar and select parameter settings, which include “Gateway Settings”, “IDU Settings”, “System Settings”, “Project Number Conflict (In case there is project number conflict in indoor units, other functions will be shielded. Then this parameter needs to be set in order to eliminate the conflict)” and “System Historical Info”. Click the corresponding set and adjust the parameters.

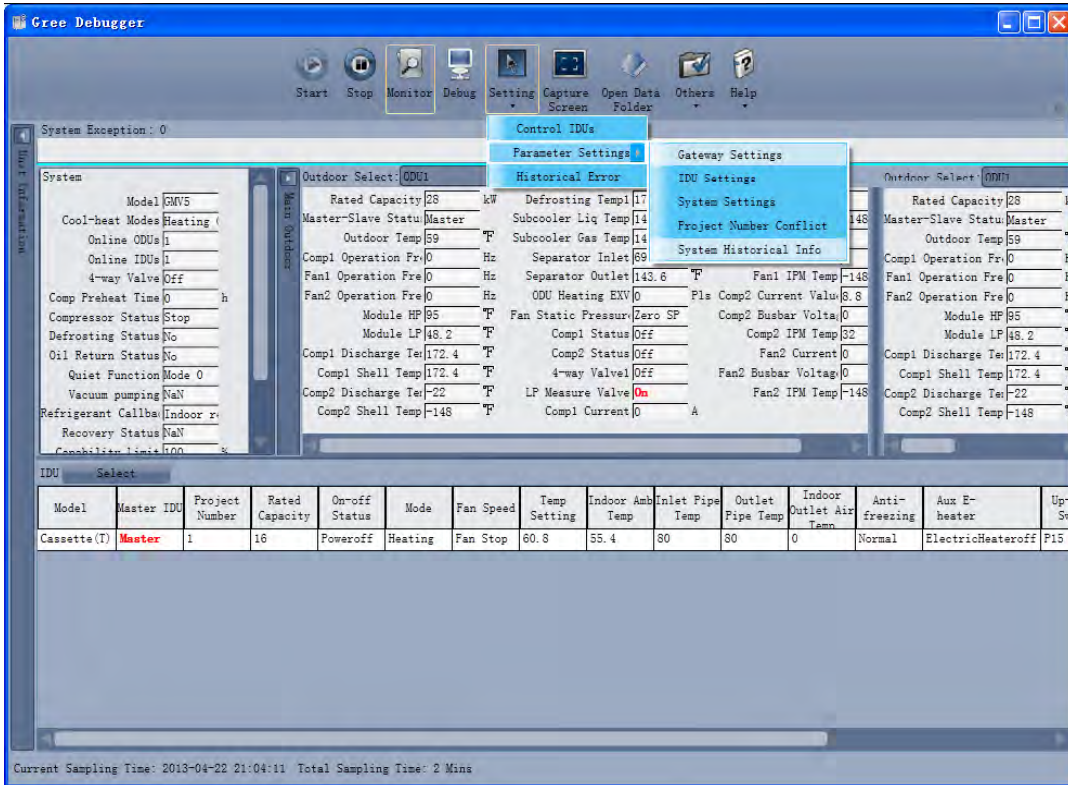

- Take indoor unit as an example. Click “IDU Settings” and a dialog box will pop up.

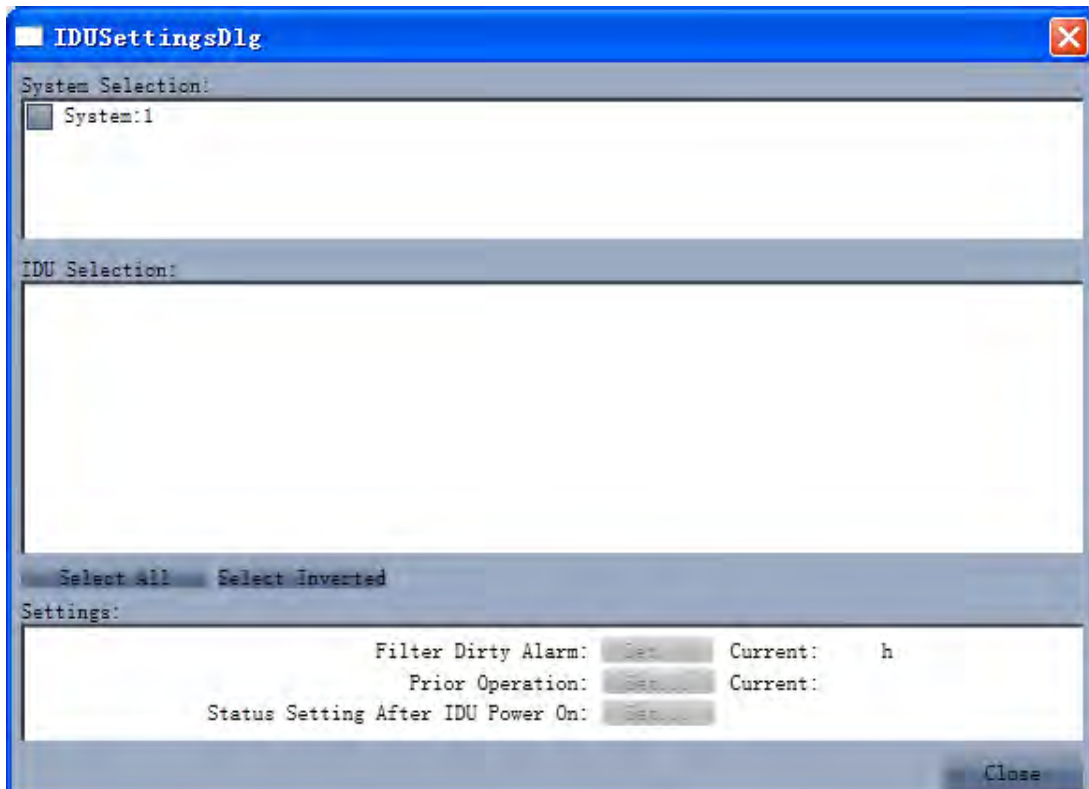

- Tick the indoor units that need setting in the IDU selection zone or you may click “Select All” to select all of them or “Select Inverted” to select none of them. After selection, the current values of the corresponding parameters will be displayed in the zone of settings. Click “Set” and then click  in the pop-up dialog box to select values. Click “Set” and then the corresponding order will be sent to units. If setting is successful, it will be displayed at the current values.

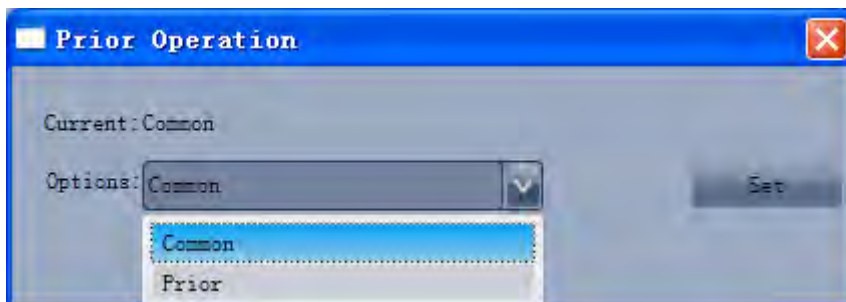
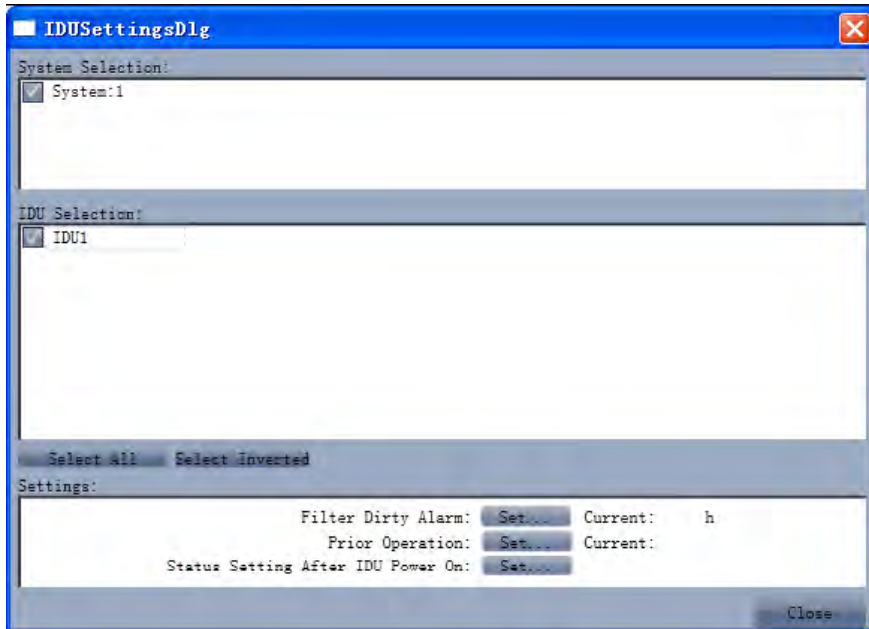

3.4.5 Other functions

Capture screen

- Click icon of “Capture Screen” to print the interface. If you want to open the interface, click “Open”.

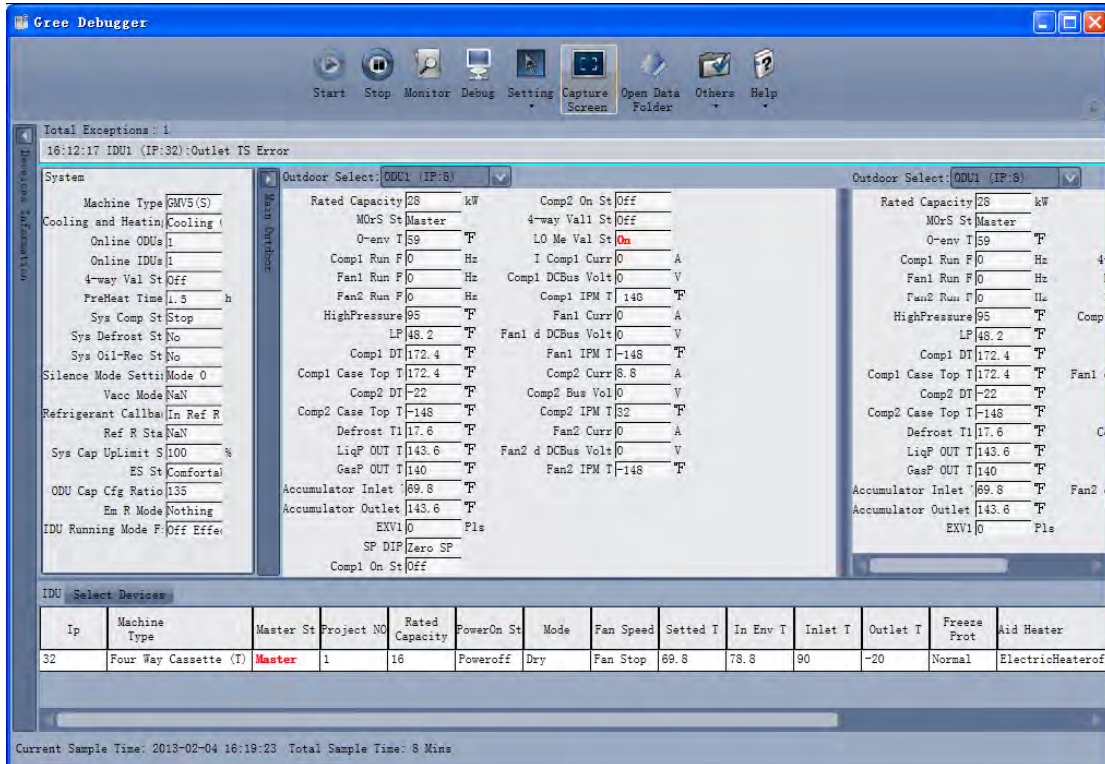
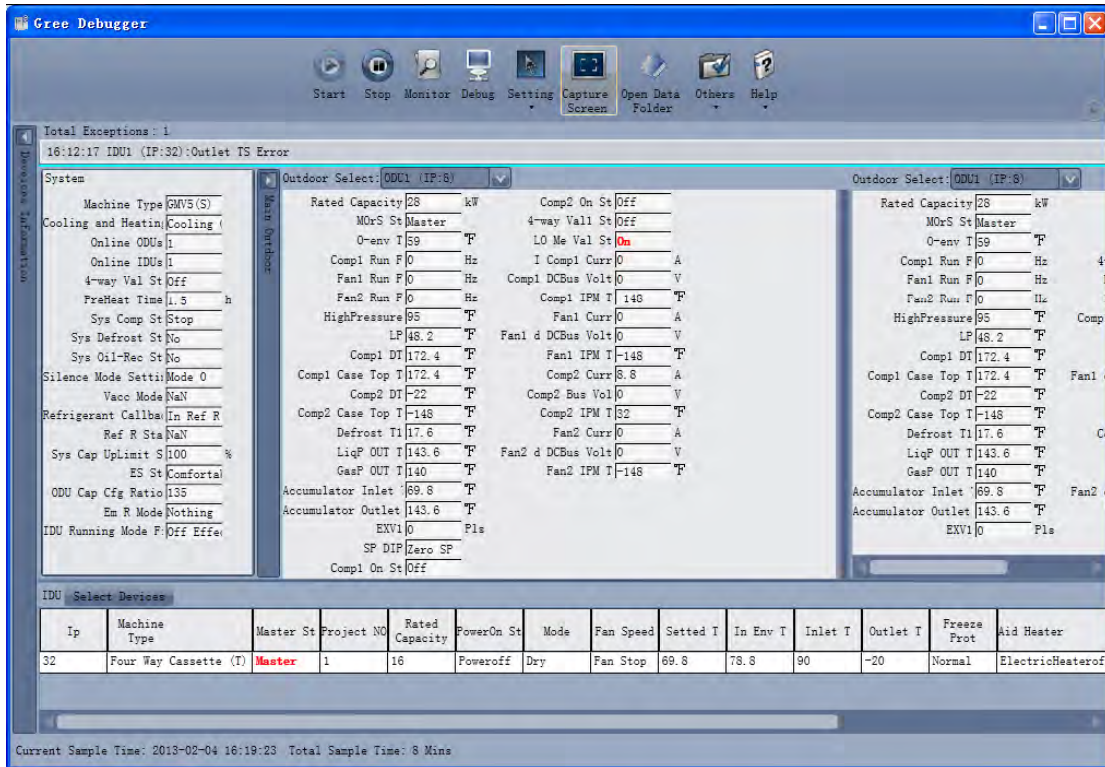

Search for database folder

- Click icon of “Open Data Folder” on the menu bar to open database folder.

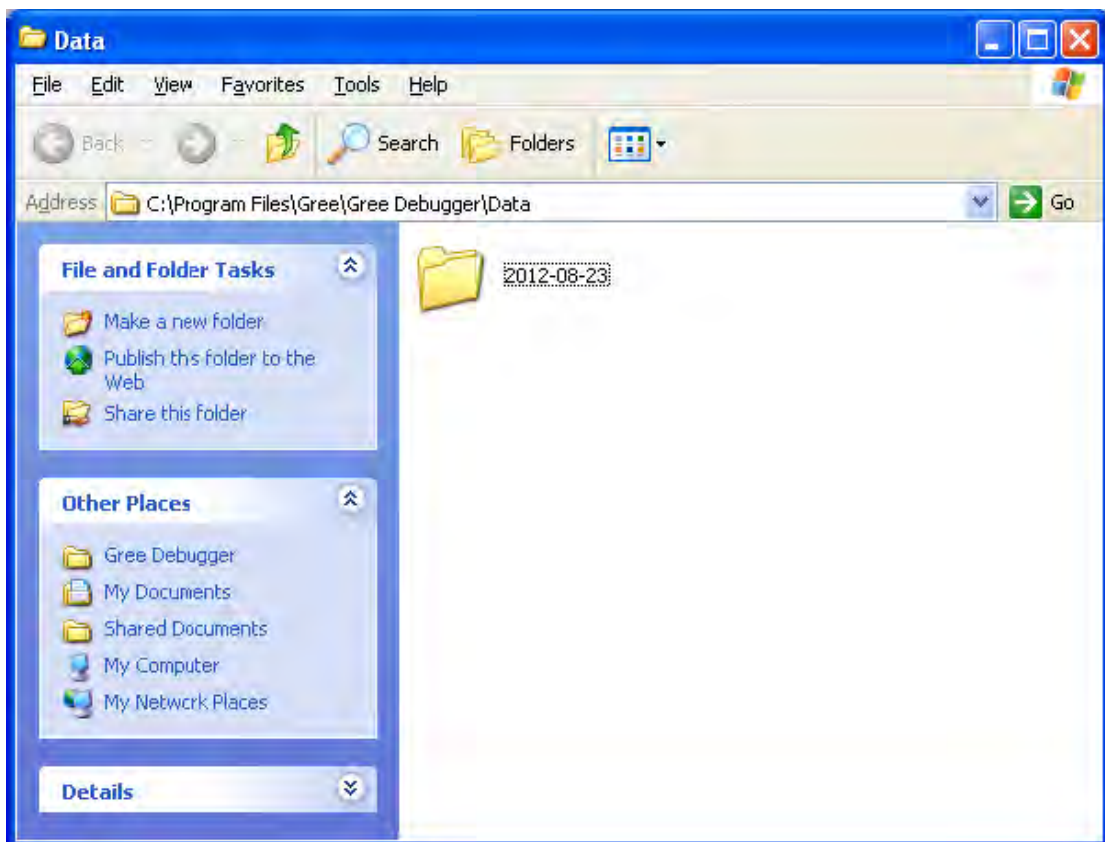
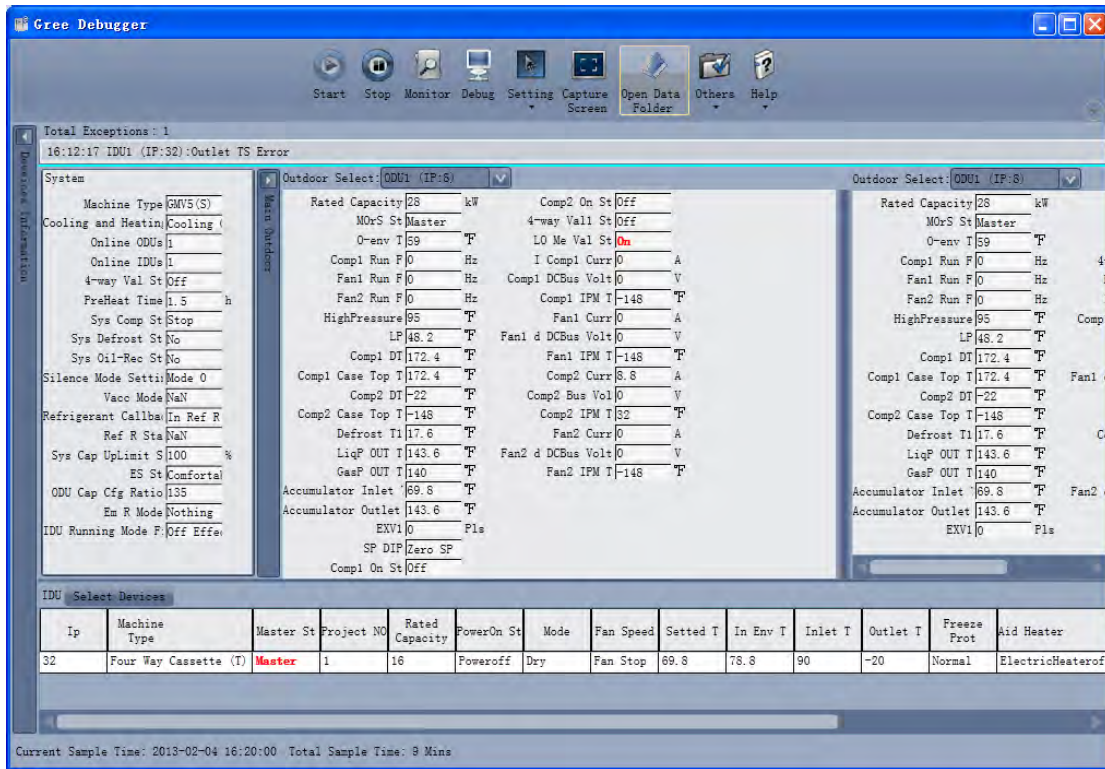

Conversion of pressure value

- Click icon of “Others” on the menu bar and then click “Display Settings” to select “High Low Pressure Value” and “Refrigerant Type”. Select “Temperature” and the pressure parameter

displayed on the interface will be temperature. Select “Pressure” and the pressure parameter displayed on the pressure interface will be pressure. Refrigerant type will affect the pressure parameter displayed on the interface.

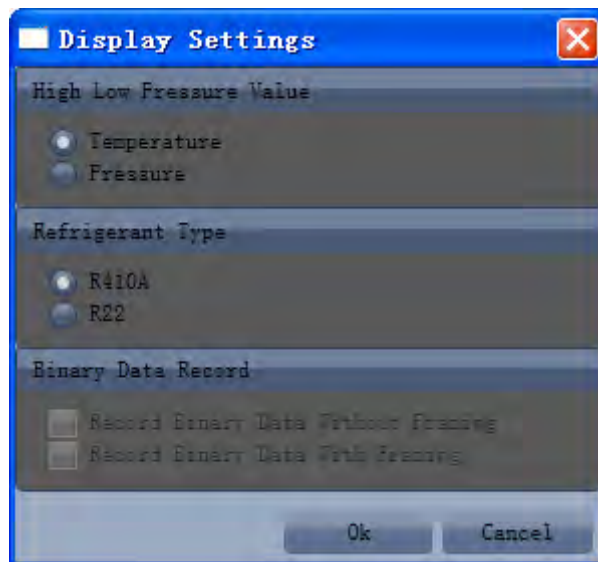
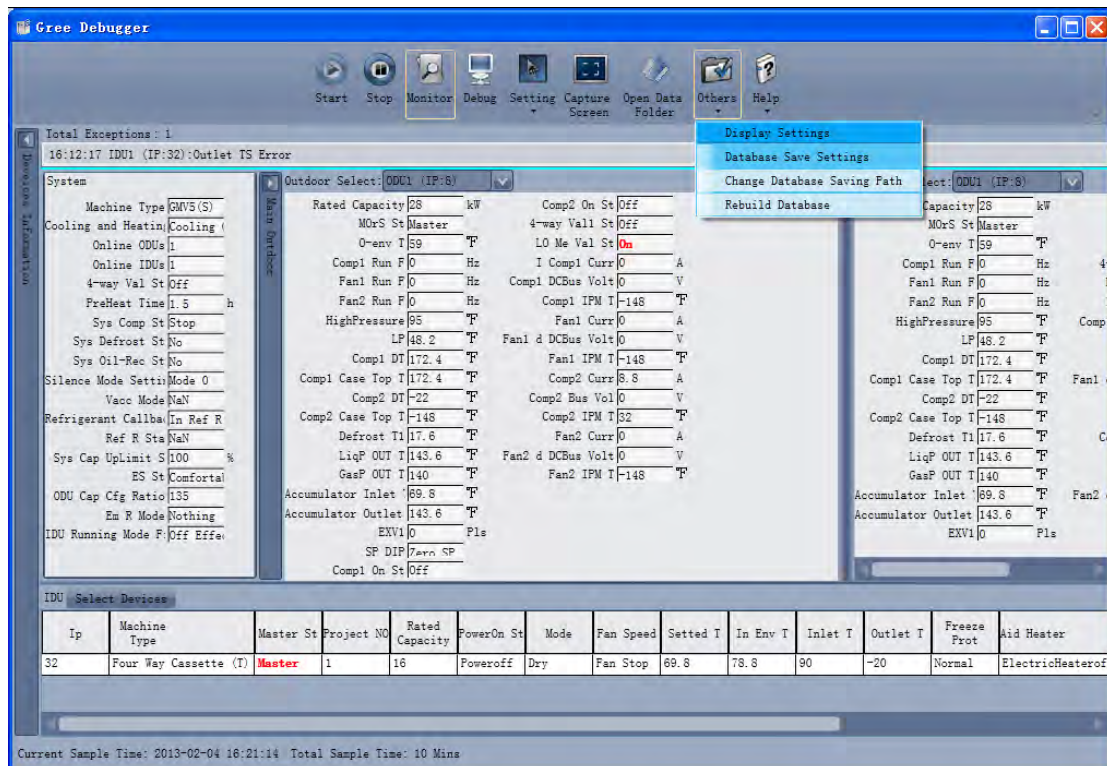

Database saving of multiple systems

- Click icon of “Others” on the menu bar and click “Database Save Settings” to select which system that needs to save database. Because there is a large quantity of data in a network that contains multiple systems, data of only one system can be saved.

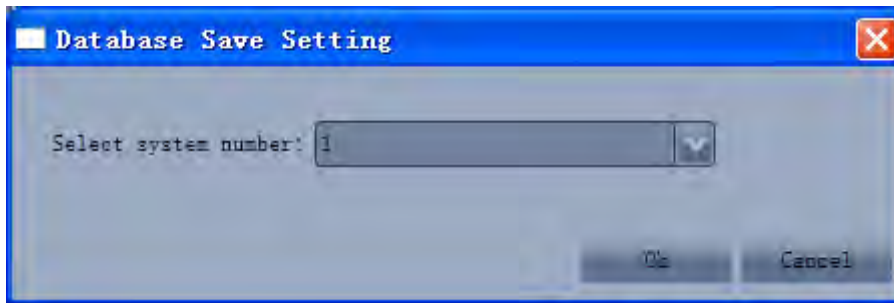
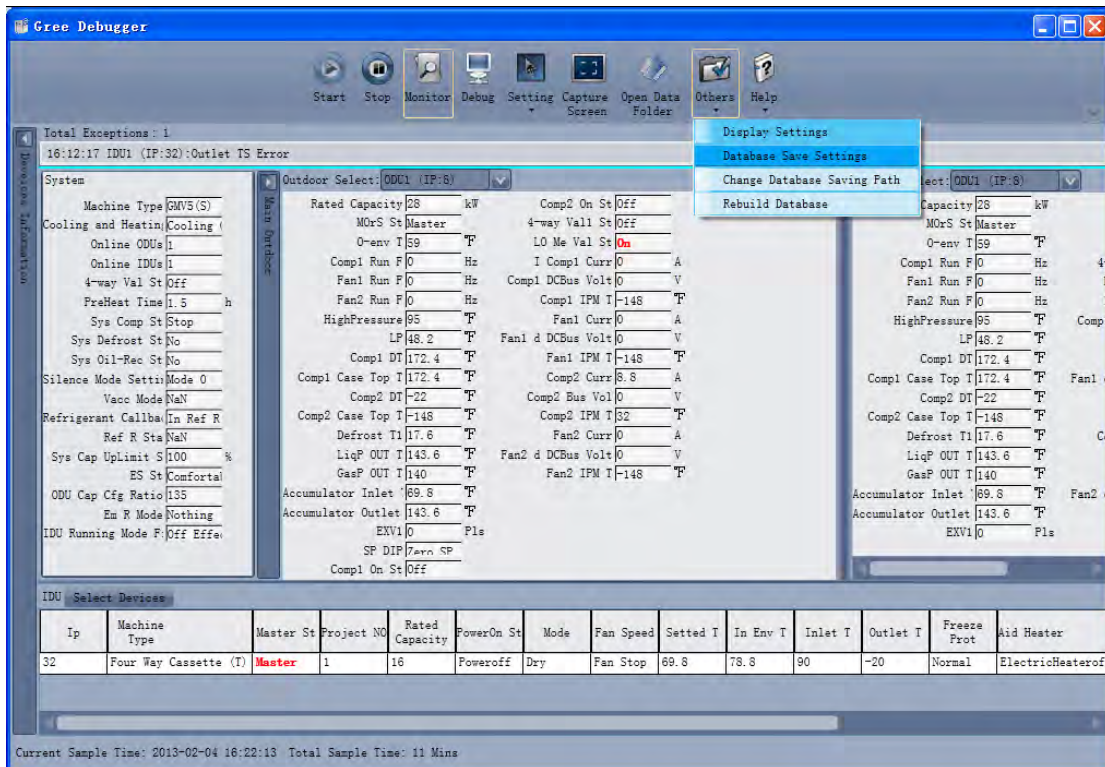

Change database saving path and rebuild database

- Change of database saving path and rebuilding of database should be set before the software starts monitoring (see below interface). Click “Change database saving path” and click “Browse” to change the saving path. Click “Rebuild Database” to rebuild the database folder. You can also stop monitoring and turn back to the connection interface to change saving path or rebuild database during monitoring.

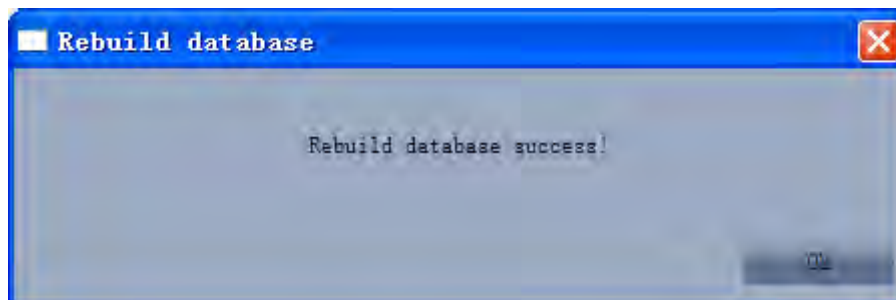
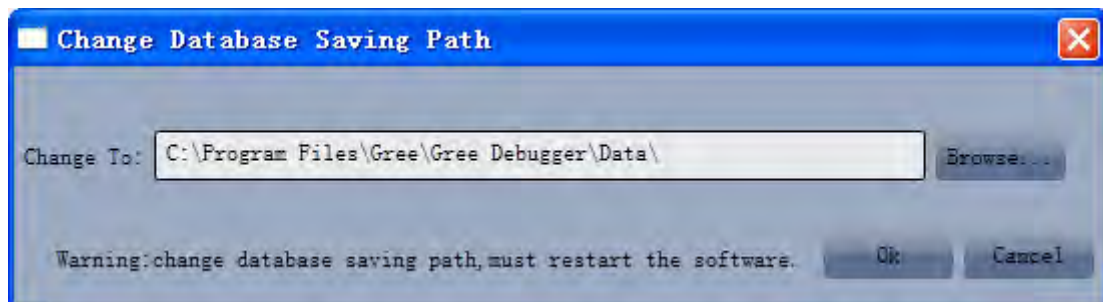
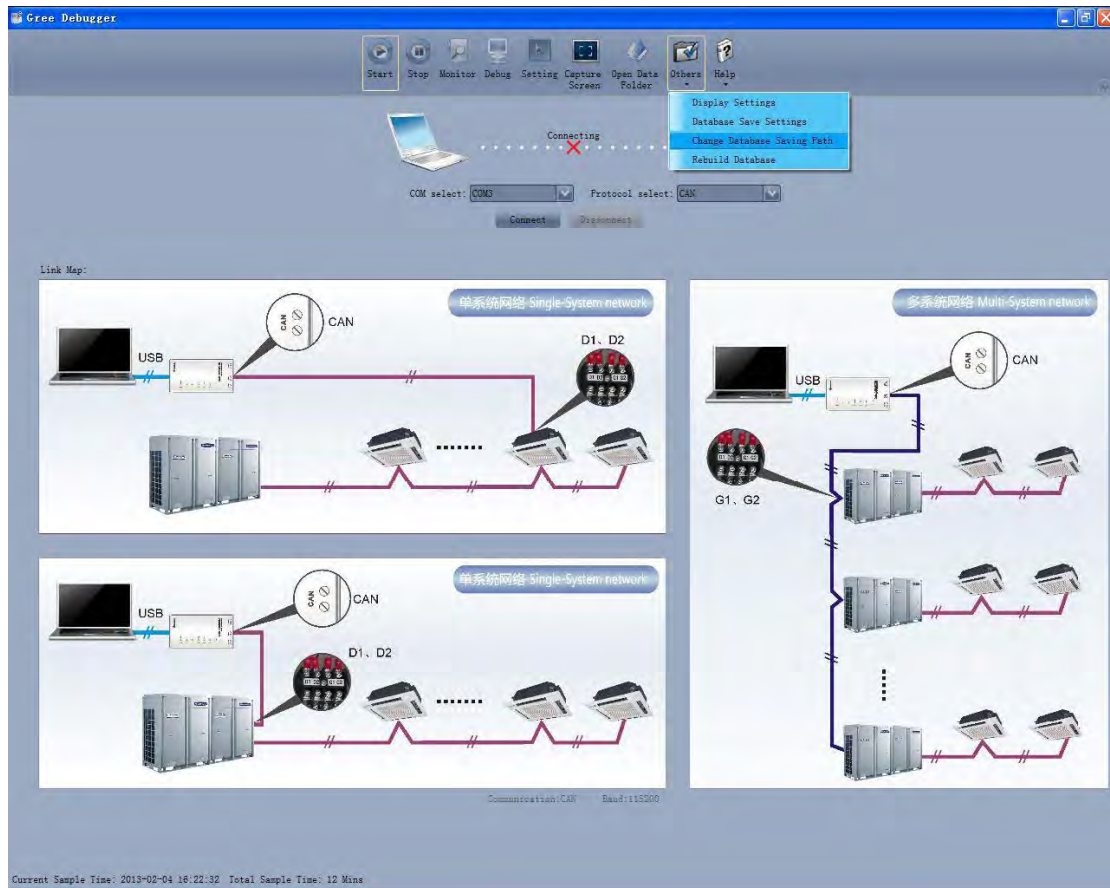

3.4.6 Usage of USB Converter

Usage of converter

- Gree commissioning software should be connected with CAN interface when converter is used. For air conditioners with a single system, connect D1 and D2 interfaces of the wiring board. For air conditioners with multiple systems, connect G1 and G2 interfaces of the wiring board.

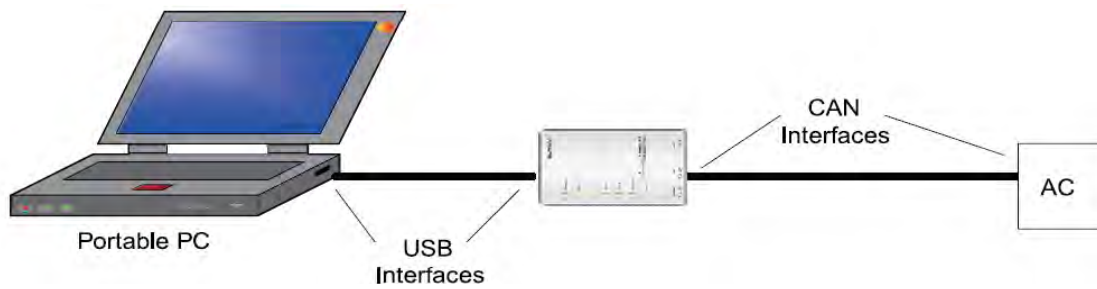

- Gree monitoring software should be connected with RS485 interface when converter is used. Connect outdoor or indoor units or the mainboard of wired controller according to actual needs.

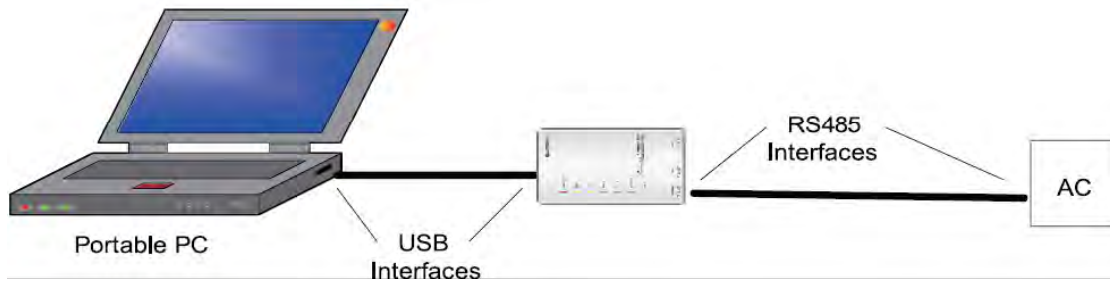

- HBS, CAN and RS485 of the converter can be switched by buttons. Press the button “SET” on the converter to realize the conversion among HBS, CAN and RS485 interfaces. You can check the setting through the function LEDs.

Notice: If it's the first time your PC uses Gree USB data converter, in order to prevent Gree USB data converter from being mistaken by your computer as other devices and make sure your mouse can work well, it is necessary to turn off the Serail Enumerator of computer after Gree USB data converter is connected. Below are the steps:

Step 1: Right-click "My Computer" on the desktop and click "Manage".



Step 2: In the pop-up window, select "Device Manager" in the left column and then find "Port (COM and LPT)" in the right column. Click its [+].

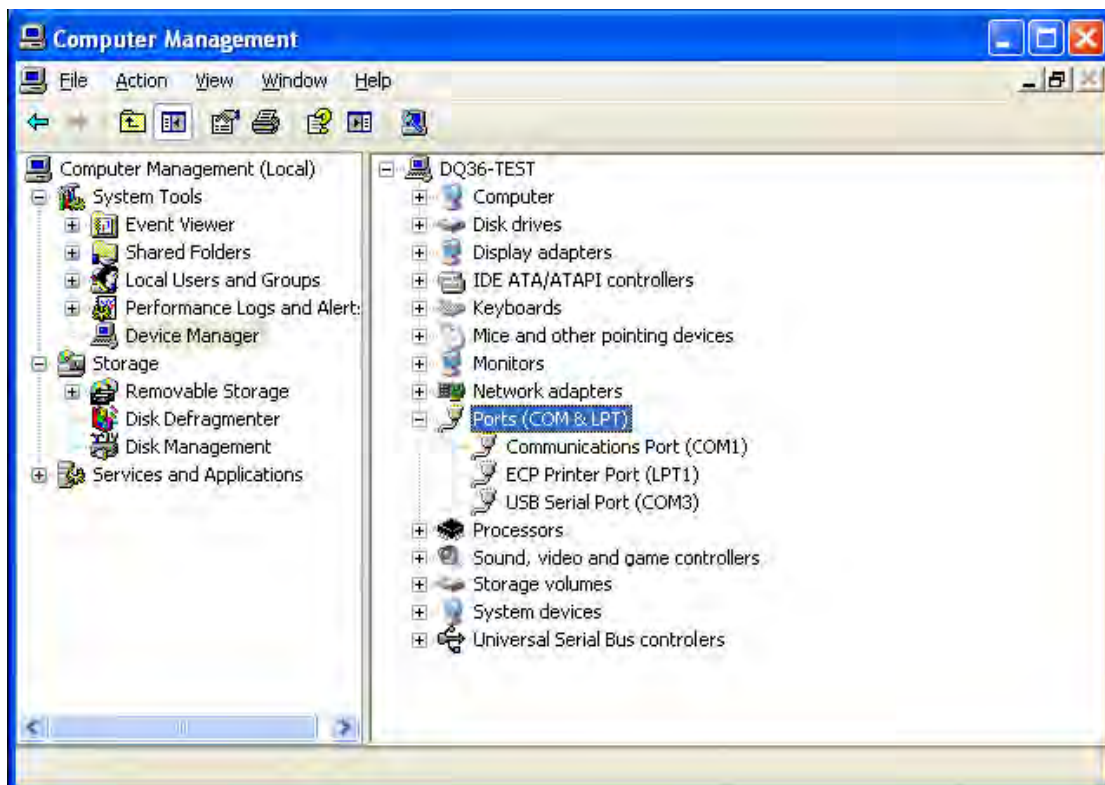
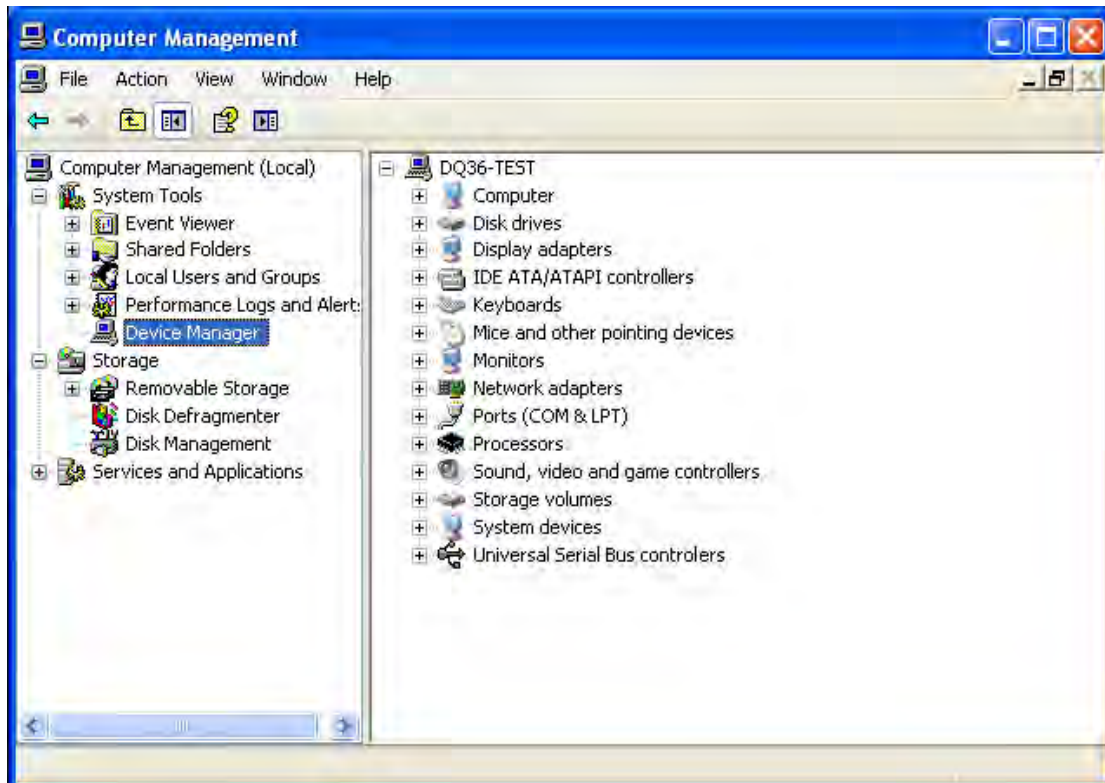

Step 4: Right-click "USB Serial Port (COM6) and then click "Properties". The dialog box of properties will then pop up.

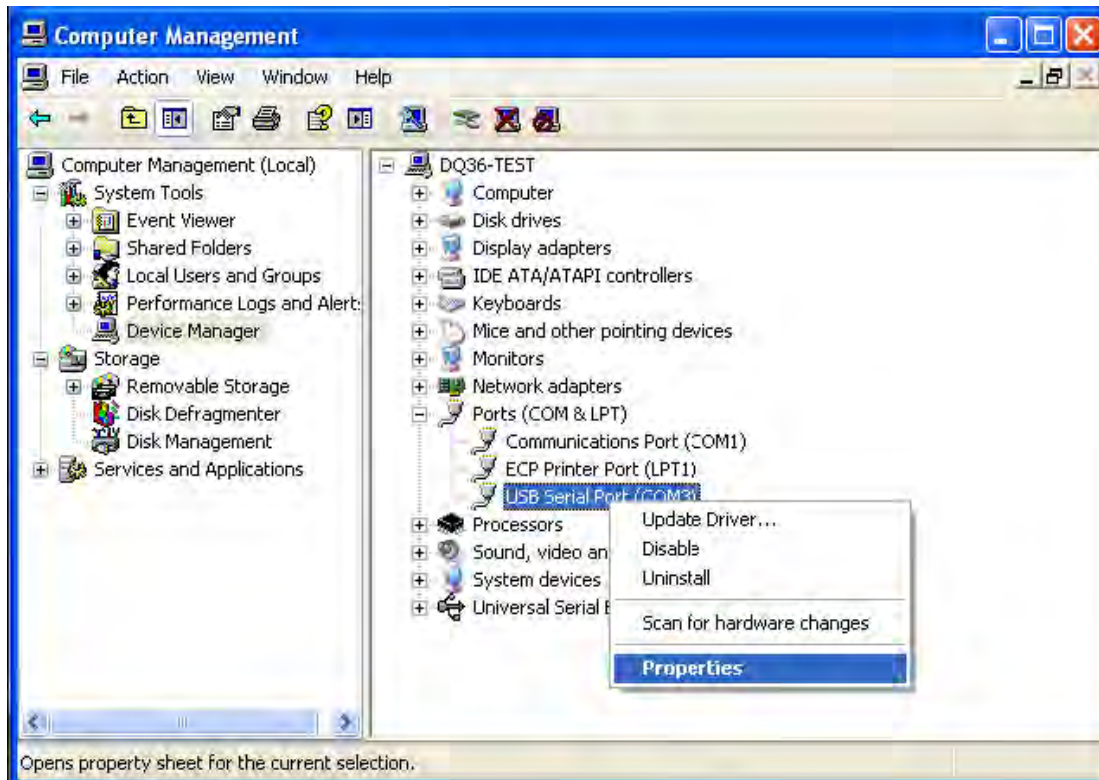

Step 5: Then click "Port Settings" in the dialog box.



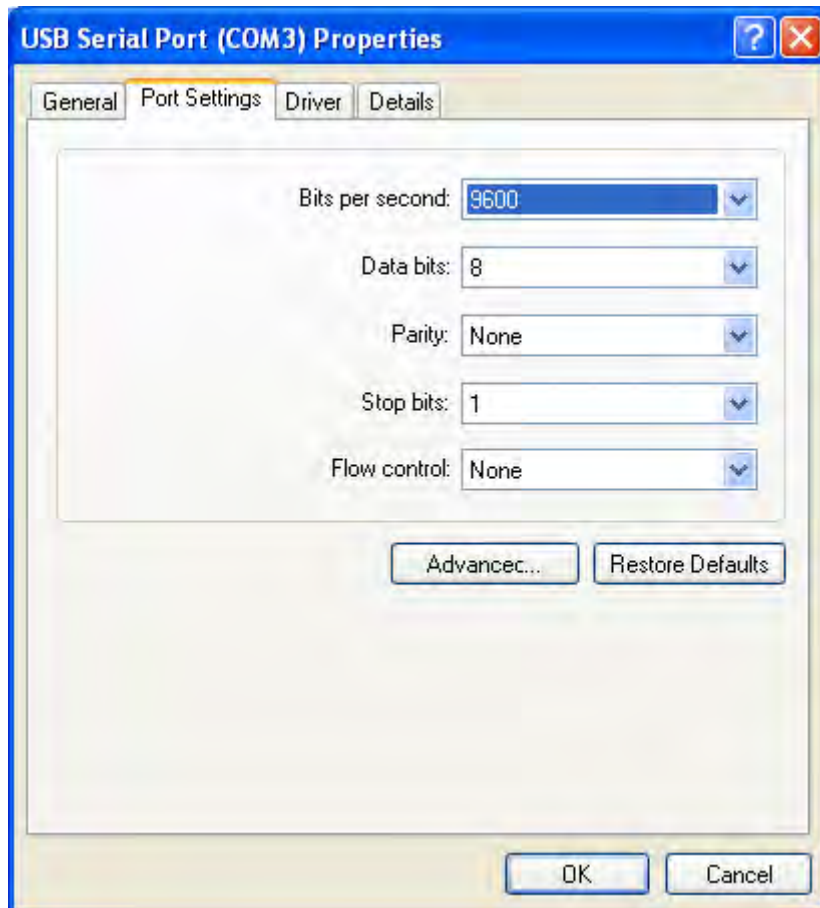

Step 6: Click "Advanced" and then a new dialog box will pop up. Find the "Serial Enumerator" in the miscellaneous options and cancel the tick. Click "OK" to exit.

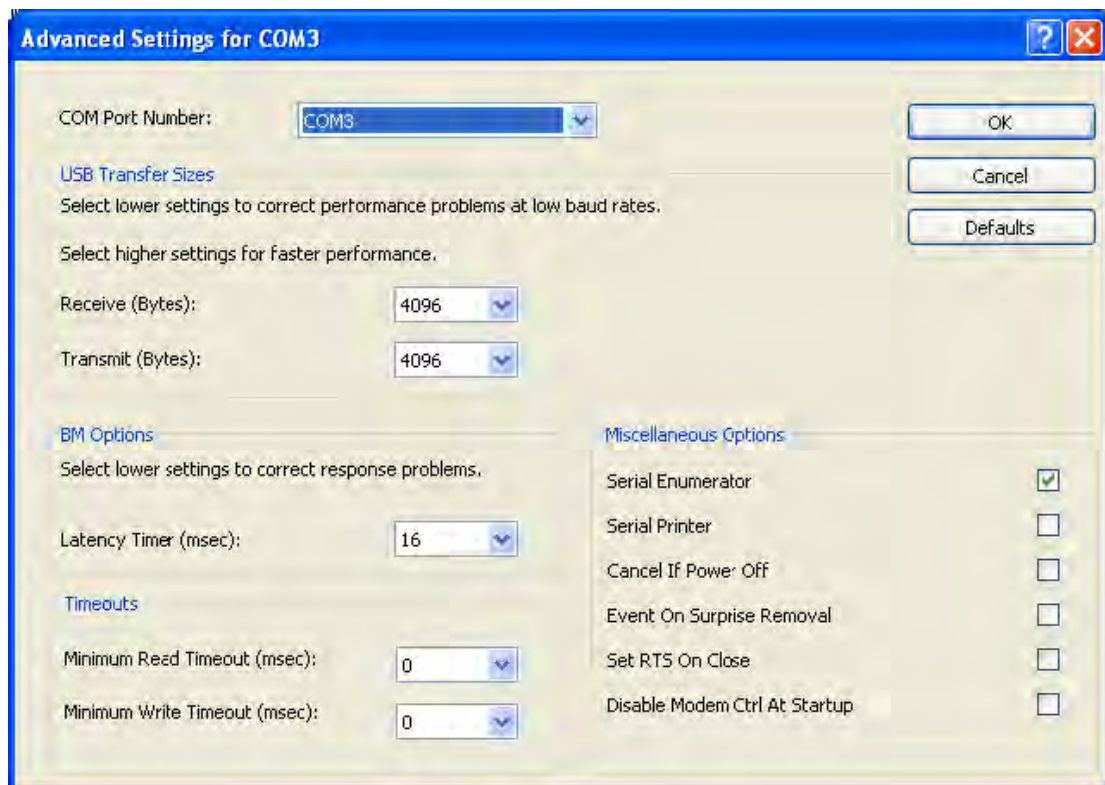

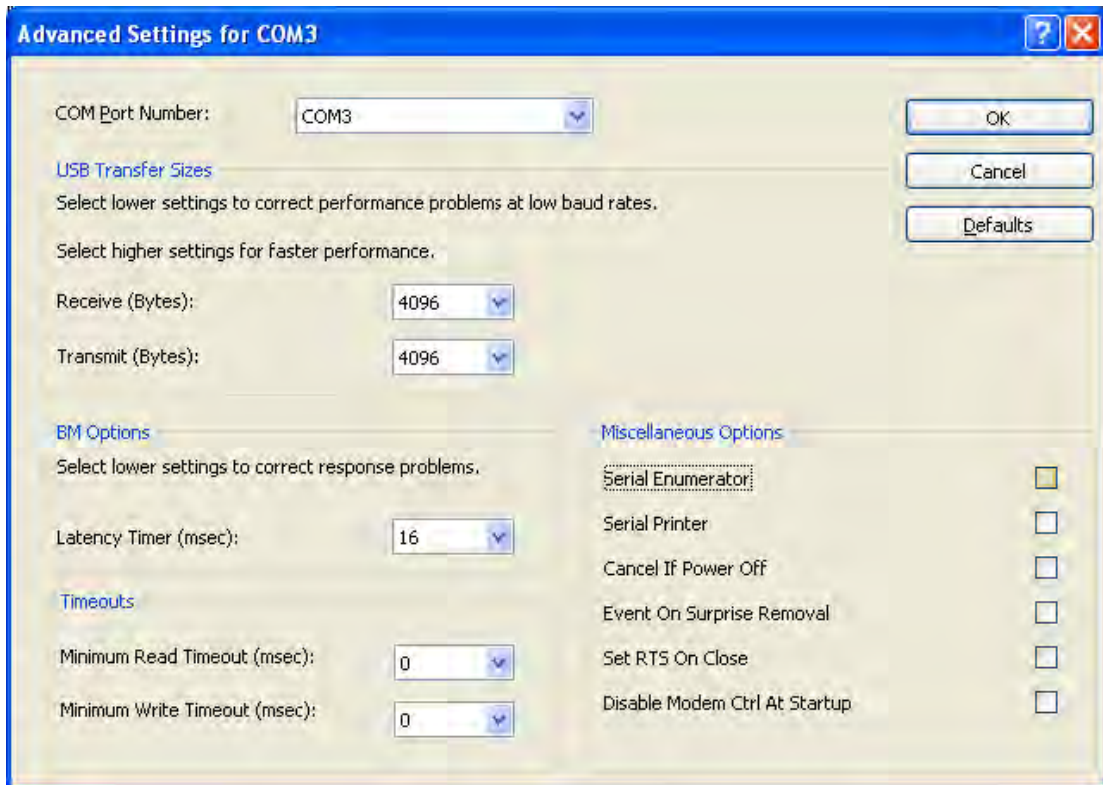

Usage of converter configuring software:

- When the converter is working, hold the button "SET" for 5 sec. Function LED will be flickering, indicating that the converter has enter the baud rate setting mode. Then you can use the converter configuring software to set the baud rate of converter. Baud rate supported by the converter (baud rate of air conditioner's communication interface matches with the baud rate of USB interface automatically):

Ex-factory defaulted baud rate: (unit: bps)

AC is connected with	Baud rate of air conditioner interface	Baud rate of USB interface
CAN	20000/50000 self-adaptive	115200
HBS	57600	38400
RS485	9600	9600

Baud rate look-up table for RS485 interface (unit: bps)

RS485 interface	4800	9600	19200	38400	57600	115200
USB interface	4800	9600	19200	38400	57600	115200

Baud rate look-up table for HBS interface (unit: bps)

HBS interface	9600	19200	38400	57600
USB interface	4800	9600	19200	38400

Baud rate look-up table of CAN interface (unit: bps)

CAN interface	20000	50000	100000	125000
USB interface	115200	115200	256000	256000

- Double-click the desktop shortcut.



- Select the needed communication serial port and language in the “System Settings”.

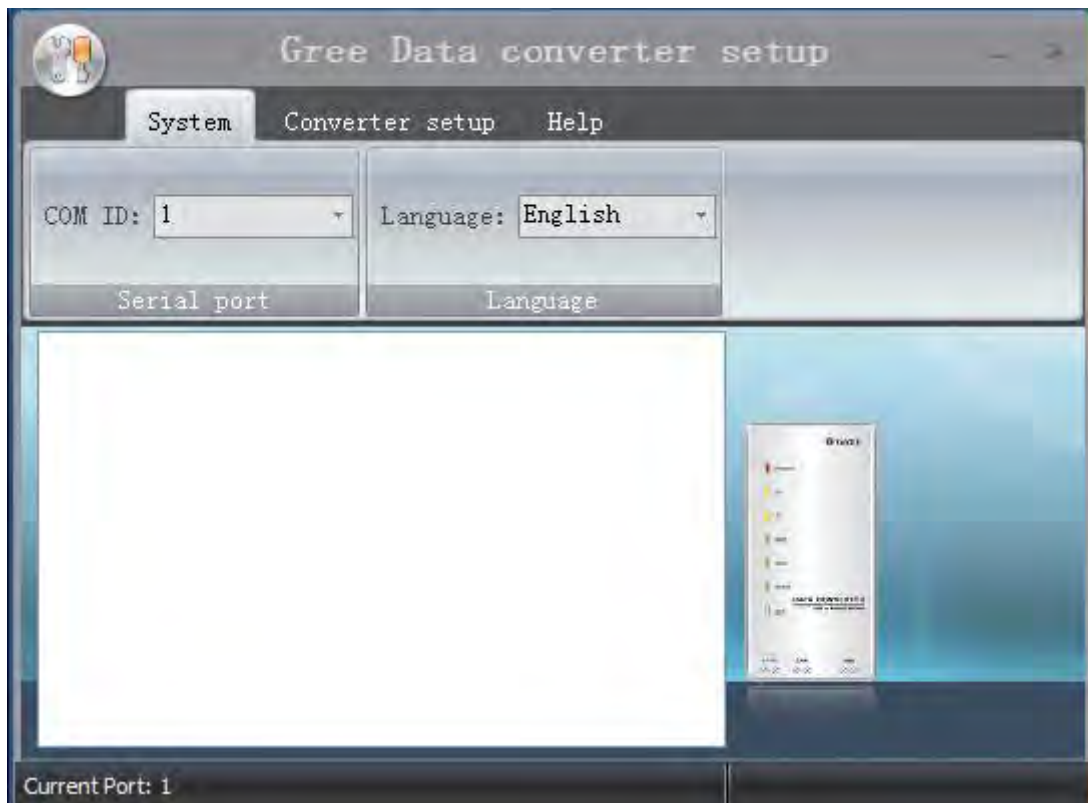

- Select the function that is to be set and the corresponding baud rate (refer to the look-up table) in the “Converter Setup”. Then click “Set”.

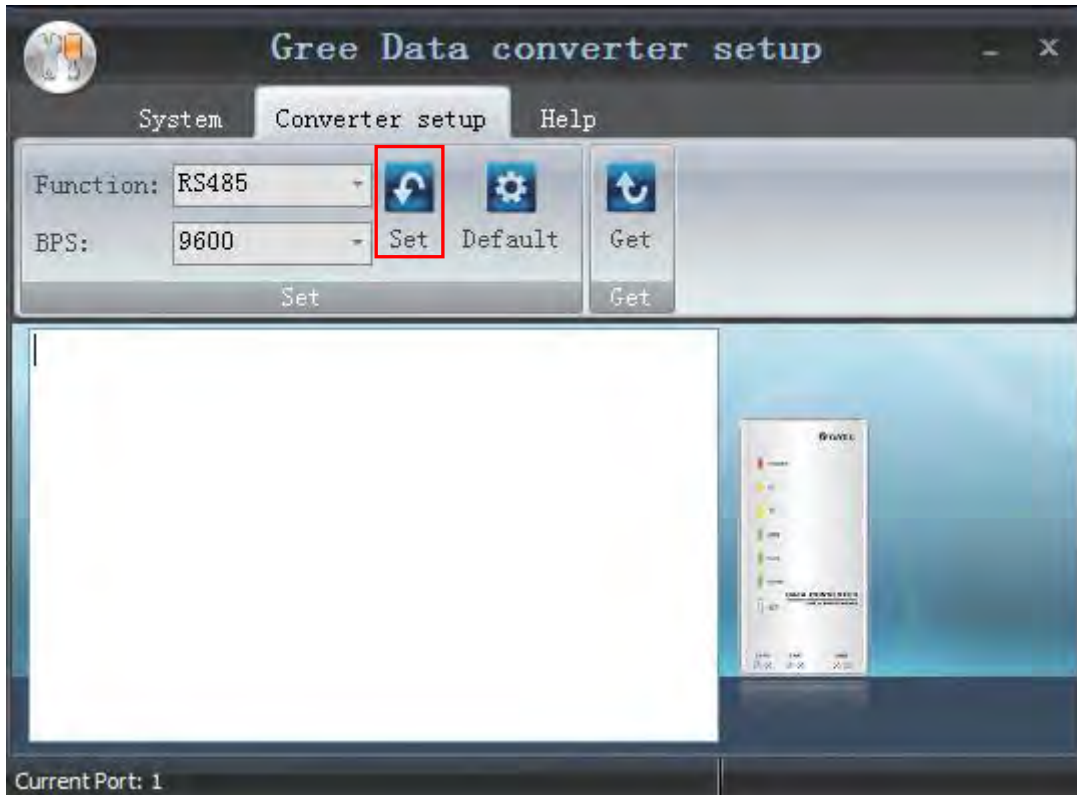

- If you want to restore ex-factory settings, click “Default” to restore the default settings.

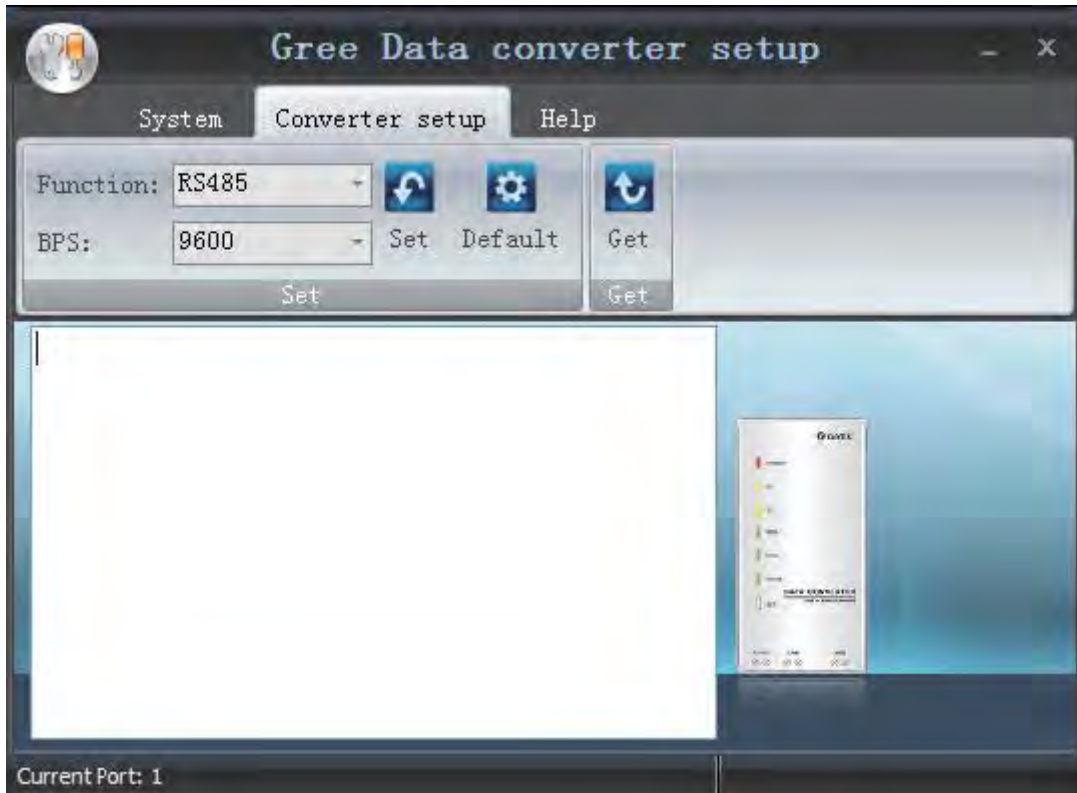

- Click “Get” to get the current setting details of converter.

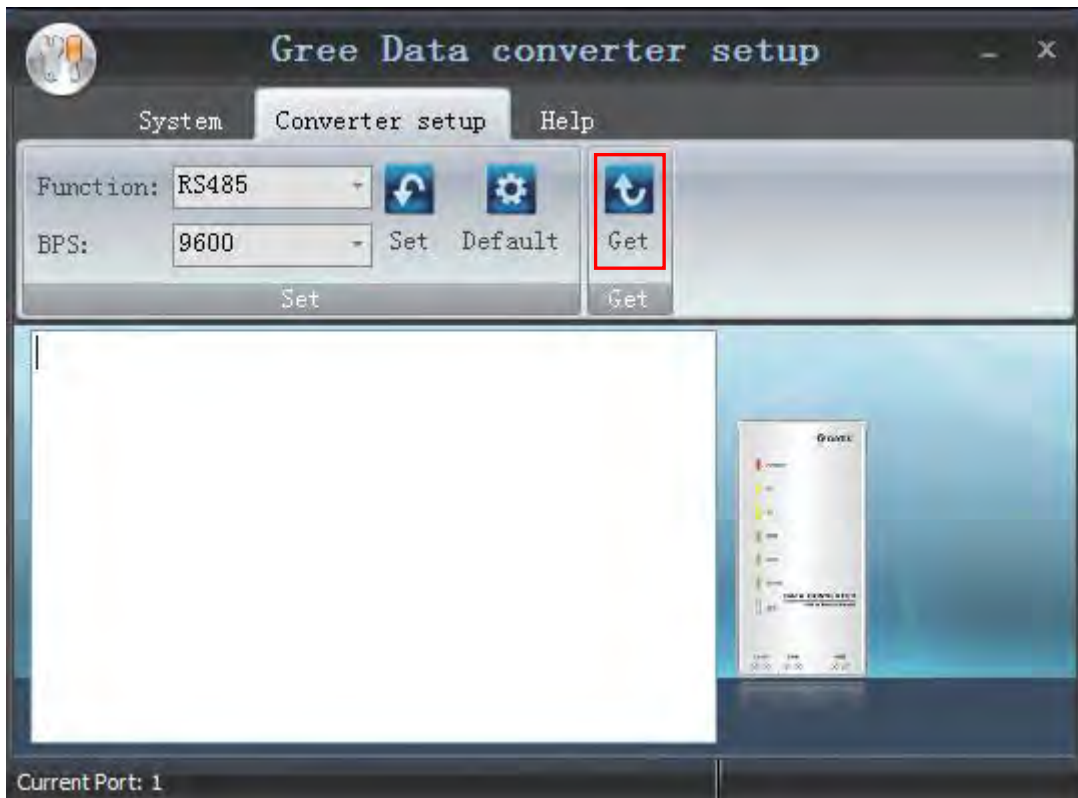

- Switchover of Software Languages

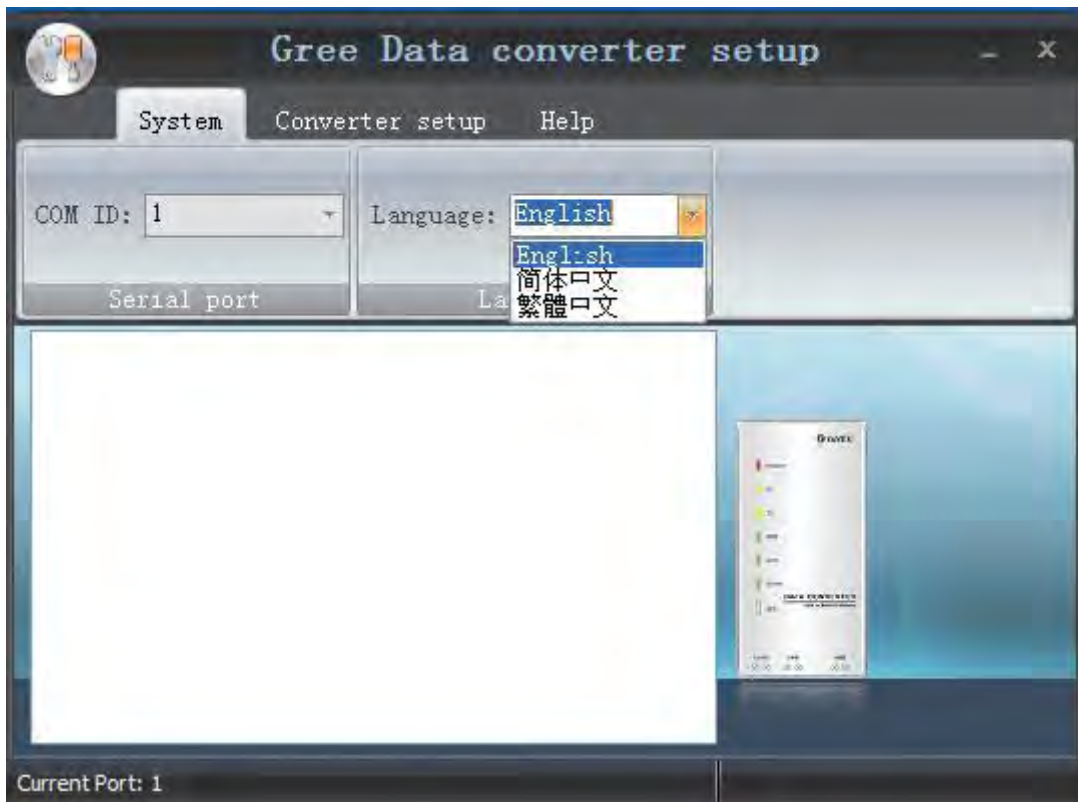

INSTALLATION

INSTALLATION

1 Engineering Installation Preparation and

Notice

1.1 Installation notice

Personnel and property safety are highly concerned during the entire installation process. Installation implementation must abide by relevant national safety regulations to ensure personnel and property safety.

All personnel involved in the installation must attend safety education courses and pass corresponding safety examinations before installation. Only qualified personnel can attend the installation. Relevant personnel must be held responsible for any violation of the regulation.

1.2 Installation key points and importance

VRF air conditioning systems use refrigerant, instead of other agent, to directly evaporate to carry out the system heat. High level of pipe cleanness and dryness is required in the system. Since various pipes need to be prepared and laid out onsite, carelessness or maloperation during installation may leave impurities, water, or dust inside refrigerant pipes. If the design fails to meet the requirement, various problems may occur in the system or even lead to system breakdown.

Problems that usually occur during installation are as follows:

No.	Installation Problem	Possible Consequence
1	Dust or impurities enter into the refrigeration system.	Pipes are more likely to be blocked; air conditioning performance is reduced; compressor wear is increased or even hinder the normal operation of the system and burn the compressor.
2	Nitrogen is not filled into the refrigerant pipe or insufficient Nitrogen is filled before welding.	Pipes are more likely to be blocked; air conditioning performance is reduced; compressor wear is increased or even hinder the normal operation of the system and burn the compressor.
3	The vacuum degree in the refrigerant pipe is insufficient.	The refrigeration performance is reduced. The system fails to keep normal operation due to frequent protection measures. When the problem getting serious, compressor and other major components can be damaged.
4	Water enters into the refrigeration system.	Copper plating may appear on the compressor and reduce the compressor efficiency with abnormal noise generated; failures may occur in the system due to ice plug.
5	The refrigerant pipe specifications do not meet the configuration requirements.	Smaller configuration specifications can increase the system pipe resistance and affect the cooling performance; larger configuration specifications are waste of materials and can also reduce the cooling performance.
6	Refrigerant pipe is blocked.	The cooling performance is reduced; in certain cases, it may cause long-term compressor operating under overheat conditions; the lubricating effect can be affected and the compressor may be burnt if impurities were mixed with the lubricating oil.
7	Refrigerant pipe exceeds the limit.	The loss in pipe is considerable and the unit energy efficiency decreases, which are harmful for long-term running of the system.
8	Incorrect amount of refrigerant is filled.	The system cannot correctly control the flow allocation; the compressor may be operating under over-heating environment or running when the refrigerant flows back to the compressor.
9	The refrigerant pipe leaks.	Insufficient refrigerant circulating in the system decreases the cooling performance of the air conditioner. Long-term operation under such circumstance may cause an overheating compressor or even damage the compressor.
10	Water drainage from the condensate water pipe is not smooth.	Residual water in IDUs can affect the normal operation of the system. The possible water leakage can damage the IDU's decoration.

No.	Installation Problem	Possible Consequence
11	The ratio of slop for condensate water pipe is insufficient or the condensate water pipe is incorrectly connected.	Reverse slop or inconsistent connection of condensate water pipe can hinder the smooth drainage and cause leakage of the IDU.
12	The air channel is improperly fixed.	The air channel will deform; vibration and noise occur during unit operating.
13	The guide vane of air channel is not reasonably manufactured.	Uneven air quantity allocation reduces the overall performance of the air conditioner.
14	The refrigerant pipe or condensate water pipe does not meet the insulation requirement.	Water can easily condensate and drip to damage the indoor decoration, or even trigger the protection mode of system due to overheating operation.
15	The installation space for IDU is insufficient.	Since there is a lack of space for maintenance and checking, indoor decoration might need to be damaged during such operation.
16	The IDU or the location of the air outlet or return air inlet is not designed reasonably.	The air outlet or return air inlet may be short-circuited, thus affecting the air conditioning performance.
17	The ODU is improperly installed.	The ODU is difficult to be maintained; unit exhaust is not smooth, which reduces the heat exchanging performance or even prevent the system from normal operation; in addition, the cold and hot air for heat exchange and the noise may annoy people in surrounding areas.
18	Power cables are incorrectly provided.	Unit components may be damaged and potential safety hazard may occur.
19	Control communication cables are incorrectly provided or improperly connected.	The normal communication in the system fails or the control over IDUs and ODUs turn in a mess.
20	Control communication cables are not properly protected.	The communication cables are short-circuited or disconnected, and the unit cannot be started up due to communication failure.

Understand the special requirement (if any) for unit installation before implementation to ensure installation quality. Relevant installers must have corresponding engineering construction qualifications.

Special type operators involved in the engineering implementation, such as welders, electricians, and refrigeration mechanics must have relevant operating licenses and are accredited with vocational qualification certification.

2 Installation Materials Selection

The materials, equipment and instruments used during air conditioning engineering construction must have certifications and test reports. Products with fireproof requirements must be provided with fireproof inspection certificates and must meet national and relevant compulsory standards. If environmentally-friendly materials are to be used as required by customers, all such materials must meet national environmental protection requirement and be provided with relevant certificates.

2.1 Refrigerant piping

- a. Material requirement: Dephosphorization drawing copper pipe for air conditioners;
- b. Appearance requirement: The inner and outer surface of pipe should be smooth without pinhole, crack, peeling, blister, inclusion, copper powder, carbon deposition, rust, dirt or severe oxide film, and without obvious scratch, pit, spot and other defects.
- c. Test report: Certifications and quality test reports must be provided.
- d. The tensile strength must be at least 240 kgf/mm².

e. Specifications requirement

R410A Refrigerant System		
OD (mm/inch)	Wall Thickness (mm)	Model
Φ6.35(1/4)	≥0.8	0
Φ9.52(3/8)	≥0.8	0
Φ12.70(1/2)	≥0.8	0
Φ15.9(5/8)	≥1.0	0
Φ19.05(3/4)	≥1.0	0
Φ22.20(7/8)	≥1.2	0
Φ25.40(8/8)	≥1.2	0

f. After the inner part of the copper pipe is cleaned and dried, the inlet and outlet must be sealed tightly by using pipe caps, plugs or adhesive tapes.

2.2 Condensate water pipe

- Pipes that can be used for air conditioner drainage include: water supplying UPVC pipe, PP-R pipe, PP-C pipe, and HDG steel pipe;
- All relevant certificates and quality test reports are provided.
- Requirements for specifications and wall thickness
 Water supplying UPVC pipe: Φ32mm×2mm, Φ40mm×2mm, Φ50mm×2.5mm;
 HDG steel pipe: Φ25mm×3.25mm, Φ32mm×3.25mm, Φ40mm×3.5mm, Φ50mm×3.5mm.

2.3 Insulation material

- Rubber foam insulation material;
- Flame retardancy level: B1 or higher;
- Refractoriness: at least 120°C;
- The insulation thickness of condensate water pipe: at least 10 mm;
- When the diameter of copper pipe is equal to or greater than Φ15.9 mm, the thickness of insulation material should be at least 20 mm; when the diameter of copper pipe is less than 15.9 mm, the thickness of insulation material should be at least 15 mm.

2.4 Communication cable and control cable

Note: For air conditioning units installed in places with strong electromagnetic interference, shielded wire must be used as the communication cables of the IDU and wired controller, and shielded twisted pairs must be used as the communication cables between IDUs and between the IDU and ODU.

Communication cable selection for ODU and IDUs

Wire Type	Communication Cables Between IDU and Indoor (Outdoor) Unit L(m)	Number of Wire Pieces x Wire Diameter (mm ²)	Wire Standard	Remark
Common sheath twisted pair copper core (RVV)	L ≤ 1000	≥ 2 × 0.75	GB/T 5023.3-2008	If the wire diameter is enlarged to 2 × 1mm ² , the overall communication length can reach 1500 m.

Communication cable selection for IDU and wired controller

Wire Type	Total Length of Communication Cables of the IDU and Wired Controller L(m)	Number of Wire Pieces x Wire Diameter (mm ²)	Wire Standard	Remark
Common sheath twisted pair copper core (RVV)	$L \leq 250$	$\geq 2 \times 0.75$	GB/T 5023.3-2008	The overall communication length cannot exceed 250 m.

2.5 Power cable

Only copper conductors can be used as power cables. The copper conductors must meet relevant national standard and satisfy the carrying capacity of unit.

2.6 Hanger rod and support

- a. Hanger rod: M8 or M10;
- b. U-steel: 14# or above;
- c. Angle steel: 30mm×30mm×3mm or above;
- d. Round steel: $\Phi 10$ mm or above

3 Installation of outdoor unit

3.1 Check before installation

- a. Before installation, please check the power cord if it complies with the power supply requirement on the nameplate. Make sure the power supply is safe.
- b. This air conditioner must be properly grounded through the receptacle to avoid electric shock. The ground wire shouldn't be connected with gas pipe, water pipe, lightning arrester or telephone line.
- c. Maintain good air circulation to avoid lacking oxygen.
- d. Read this manual carefully before installation.

3.2 Selection of installation site

- a. Select a location which is strong enough to hold unit's weight so that unit can stand still and erect.
- b. Make sure the unit is not exposed to sun and rain. And the location can resist dust, typhoon and earthquake.
- c. Please keep the unit away from inflammable, explosive and corrosive gas or waste gas.
- d. Make sure the location has space for heat exchange and maintenance so that unit can operate reliably with good ventilation.
- e. ODU and IDU should stay as close as possible to shorten the length of refrigerant pipe and reduce bend angles.
- f. Select a location which is out of children's reach. Keep the unit away from children.

3.3 Carrying and installing outdoor unit

When carrying the outdoor unit, hang the unit in four directions with two sufficient ropes. In order to avoid excursion from the center, the angel of ropes must be smaller than 40° during hanging and moving.

3.4 Installation notices

In order to ensure proper operation, the selection of installation site must conform to the following principle:

- The discharged air of outdoor unit will not flow back and there is sufficient space around the unit for maintenance;
- The installation site must be well ventilated to ensure sufficient air intake and discharge. Make sure there is no obstacle at the air inlet and air outlet. If there is any obstacle, please remove it;
- The installation site shall be able to withstand the weight of outdoor unit and capable for soundproof and vibration. The air outlet and noise of unit will not affect neighbors;
- The hanging of outdoor unit must use appointed hanging hole. Pay attention to protect the unit during hanging and installation. Prohibit hitting the sheet metal to avoid rust in the future.
- Avoid direct sunlight;
- The rain and condensation water can be drained out smoothly;
- The outdoor unit will not be embedded by the snow and not affected by garbage and oil smog;
- The installation of outdoor unit shall adopt rubber damping pad or spring damper to reduce noise and vibration;
- The installation dimension shall accord with the installation requirement of this manual and the outdoor unit must be fixed at the installation site;
- The installation shall be done by professional technicians.

3.5 Fixing and damping of unit

The outdoor unit shall be fixed with 4 M12 bolts and closely contacted with the foundation. Otherwise, big vibration and noise will be caused.

The outdoor unit shall be fixed firmly. The rubber board with thickness over 20mm or corrugated rubber damping pad shall be applied between the unit and foundation.

3.6 Outline dimension and position of installation hole

When carrying the outdoor unit, hang the unit in four directions with two sufficient ropes. In order to avoid excursion from the center, the angel of ropes must be smaller than 40° during hanging and moving.

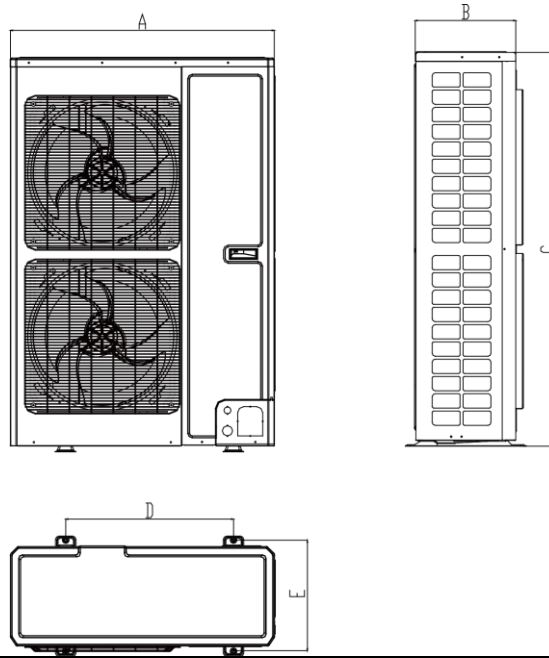

Model	A	B	C	D	E
GMV-120WL/A-T GMV-140WL/A-T GMV-160WL/A-T GMV-120WL/A-X GMV-140WL/A-X GMV-160WL/A-X GMV-120WL/C-T GMV-140WL/C-T GMV-160WL/C-T GMV-120WL/C-X GMV-140WL/C-X GMV-160WL/C-X	900	340	1345	572	378
GMV-H224WL/A-X GMV-224WL/C-X	940	320	1430	632	350
GMV-H280WL/A-X GMV-H335WL/A-X GMV-280WL/C-X GMV-335WL/C-X	940	460	1615	610	486

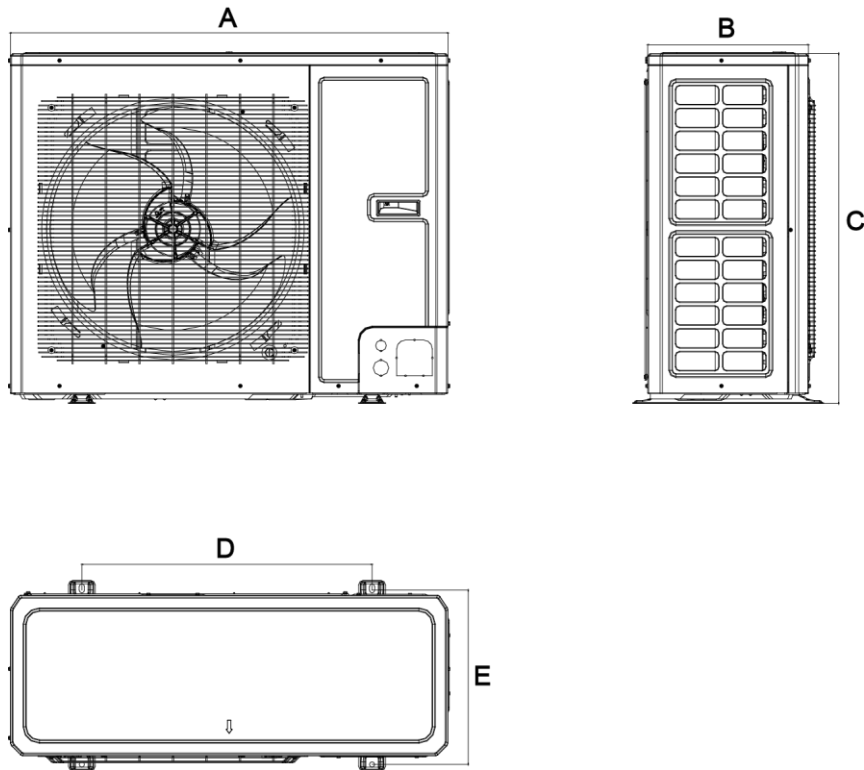

Unit: mm

Model	A	B	C	D	E
GMV-80WL/A-T	980	360	790	650	395
GMV-100WL/A-T					
GMV-121WL/A-T					
GMV-80WL/C-T					
GMV-100WL/C-T					
GMV-121WL/C-T					

3.7 Installation space requirement

If all sides of the ODU (including the top) are surrounded by walls, process according to the following requirements for installation space:

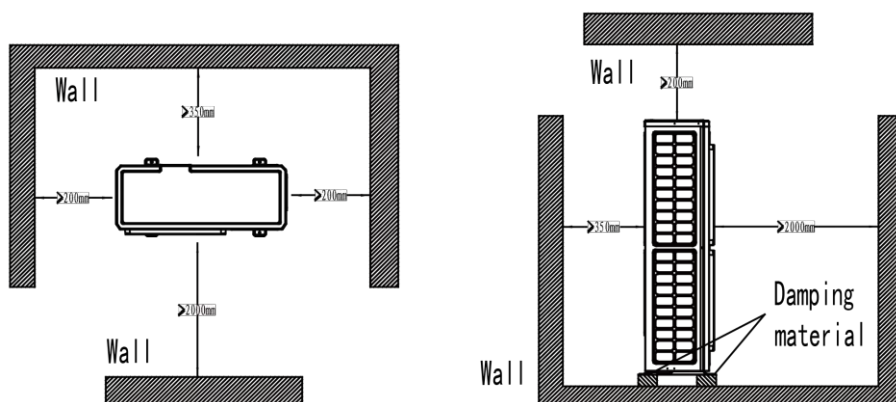

DEBUGGING & MAINTENANCE

DEBUGGING & MAINTENANCE

1 Debugging of Unit

Caution:

1. After the initial installation is finished and the main board of outdoor unit is replaced, it must perform debugging. Otherwise, the unit can't operate.
2. The debugging must be performed by professional person or under the the guide of professional person.

1.1 Preparation for debugging

- (1) Do not disconnect the power before the installation is finished,
- (2) All wires for controller and electric wires must be connected correctly and reliably.
- (3) Check the the fixing ring of the foot of compressor for transportaion is removed.
- (4) Remove all sundries from the unit, such as metal chips, joint, forceps holder, and so on.
- (5) Check whether the appearance and pipeline system are damaged during carry or transportation process.
- (6) Calculate the required added refrigerant-charging volume according to the length of pipe of system and pre-charge the refrigerant. If refrigerant can't be added any more when the required refrigerant-charging volume hasn't been reached, record to refrigerant volume which still needs to be added and continue to add refrigerant during run test operation process. Please refer to below run test for the refrigerant-adding stage during run test process.
- (7) After adding refrigerant, please make sure the valve for outdoor is opened completely.
- (8) For the convenient of troubleshooting, the unit can't be connected to the PC which installed with related debugging software and make sure that the the datas in real time of this unit can be inspected by this computer. Please refer to Service Manual for the installation and connection of the bebugging software.
- (9) Before turn test, please do make sure that the preheat time for compressor is 8h above and touch the compressor to see whether preheat is normal. You can perform run test only after normal preheat. Otherwise, it may damage the compressor.

1.2 Debugging of unit

Debugging procedure for test run, display instruction for indicator on main board of outdoor unit and operation method are as below:

Stage process instruction for debugging							
—	Debugging code		Process code		Status code		Code instruction and operation method
Process	LED1		LED2		LED3		
	Code	Display status	Code	Display status	Code	Display status	
01_ Main control unit setting	00	ON	OF/A C/AH	ON	A0	ON	No debugging status for system
	db	ON	01	ON	OC	ON	Press SW7 button on main board for 5s to start system debugging. The indicator on main board is displayed as shown in the left. 2s later, it will enter into next step determination.
02_ Address distribution	db	ON	02	ON	Ad	Flash	Address distribution for the system. 10s later, the display is as below:
	db	ON	02	ON	L7	Flash	No main indoor unit. Display will be kept for 1min. Within 1min, set the main indoor unit through debugging software. If notset the main indoor unit by hand within 1min, the system will automatically set the minimum IP address as the main indoor unit.
	db	ON	02	ON	OC	ON	The distribution for the system address is finished. 2s later, it will enter into the next step determination automatically.
03_ Quantity confirmation of outdoor unit	db	ON	03	ON	01	Flash	Cofirmation process of system. 1s later, it will enter into the next step automatically.
	db	ON	03	ON	OC	ON	Cofirmation process of system. 2s later, it will enter into the next step automatically.
04_ Quantity confirmation of indoor unit	db	ON	04	ON	01~8 0	Flash	LED3 displays quantity of indoor unit. The quantity of indoor unit shall be confirmed by perform. If the actual quantity of indoor unit is different from the displayed quantity, cut off the power for indoor unit and outdoor unit. Check whether the communication wire for indoor unit is normal. After that, put through the power and start debugging from step 01. If the quantity of indoor unit is correct, press SW7 button on main board to confirm it. The display is as below after confirmation:
	db	ON	04	ON	OC	ON	Confiration for the quantity of indoor unit of finished. 2s later, it will enter into the next step automatically.
05_ Internal communication	db	ON	05	ON	C2	ON	Communication between main board of outdoor unit and drive is abnormal. Please check whether the communication wire connecting main board of outdoor unit and drive board is normal? It will enter

Stage process instruction for debugging							
—	Debugging code		Process code		Status code		Code instruction and operation method
Process	LED1		LED2		LED3		
	Code	Display status	Code	Display status	Code	Display status	
and capacity ratio inspection for between indoor unit and outdoor unit							into the next operation after troubleshooting. If it needs to cut off the power during troubleshooting process, start the debugging from step 01 after energization.
	db	ON	05	ON	OC	ON	Normal communication between main board of outdoor unit and drive. It will displays for 2s by the left method. With this 2s, the capacity ratio for indoor unit and outdoor unit will be detected automatically. If it hasn't exceeded the capacity ratio range, it will enter into next step determination after 2s; if it has exceed the capacity ratio, display is as below:
	db	ON	05	ON	CH	ON	The rated capacity ratio for indoor unit is high. Change the combination for indoor unit and outdoor unit to let their capacity ration is within the reasonable range. Perfrom the debugging again from step 01.
	db	ON	05	ON	CL	ON	The rated capacity ratio for indoor unit is low. Change the combination for indoor unit and outdoor unit to let their capacity ration is within the reasonable range. Perfrom the debugging again from step 01.
06_Parts detection for outdoor unit	db	ON	06	ON	Corresponding error code	ON	Malfunction of parts for outdoor unit. LED3 displays corresponding malfunction code. After troubleshooting, it will enter into the next step determination automatically. If it needs to cut off the power for the outdoor unit during troubleshooting process, perform the debugging again from step 01 after energization.
	db	ON	06	ON	OC	ON	When there's no malfunction of parts for outdoor unit, it will enter into the next step determination automatically after 10s.
07_Parts detection for indoor unit	db	ON	07	ON	XXXX /corresponding error code	ON	The system detected that there's malfunction for the parts of indoor unit. XXXX indicates the engineering series code for the indoor unit with malfunction. 3s later, corresponding malfunction code will be displayed. Eg: When there is malfunction d5 and d6 for no. 1 indoor unit, and malfunction d6 and d7 for no. 792 indoor unit, LED3 nixie tube will display 00, 01, d5, d6, 07, 92, d6, d7 cyclely every 2s. After troubleshooting, it will enter into the next step determination automatically. If it needs to cut off power for outdoor unit during troubleshooting process, perform the debugging again from step 01 after energization.
	db	ON	07	ON	OC	ON	No parts malfunction for indoor unit. 2s later, it will enter into the next determination automatically.
08_Preheat confirmation for compressor	db	ON	08	ON	UO	ON	Preheat time for compressor is not reached to 8h. Indicator will display as shown by the left method until the reheat time for compressor is reached to 8h. or short press SW7 button on main board to confirm that the preheat time is reached to 8h and then enter into the next determination. (Note: If compressor isn't started up when the preheat time is not reached to 8h, the compressor may be damaged. Please be careful.)
	db	ON	08	ON	OC	ON	Preheat time for compressor is reached to 8h. 2s later, it will enter into the next step.

Stage process instruction for debugging							
—	Debugging code		Process code		Status code		Code instruction and operation method
Process	LED1		LED2		LED3		
	Code	Display status	Code	Display status	Code	Display status	
09_ Refrigerant confirmation before startup	db	ON	09	ON	U4	ON	Refrigerant in system is not sufficient. The indicator will display by the left method. Please disconnect the power for indoor unit and outdoor unit, and check whether the pipeline is leaking. After leakage problem is solved, recharge the refrigerant according to requirement. After that, energize the unit and perform the debugging from step 01. (Note: Cut off the power for the unit before recharging the refrigerant to prevent the unit entering into step 10 during refrigerant-charging process)
	db	ON	09	ON	OC	ON	The refrigerant volume for the system is normal. After it displays as the left method for 2s, it will enter into the next determination automatically.
10_ Status determination for outdoor unit's valve before startup	db	ON	10	ON	ON	ON	Determination status for valve of outdoor unit; After compressor operating for about 2min, it will stop operation. It will judge the ON status of gas valve and liquid valve for outdoor unit. The judgement result is displayed as below:
	db	ON	10	ON	U6	ON	Valve for outdoor unit hasn't been opened completely. Short press SW6 button on main board and the indicator will display "db 09 OC" and then check whether gas valve and liquid valve for outdoor unit are opened completely. After that, short press SW6 button on main board again. After compressor is started up and operated for about 2min, it will judge the status of valve again.
	db	ON	10	ON	OC	ON	Normal status for valve. After it displays as the left method for 2s, it will enter into the next determination automatically.
12_ Debugging confirmation for the unit	db	ON	12	ON	AP	Flash	Wait for confirming the debugging order for the unit. Short press SW7 button on main board to confirm the debugging of unit. 2s later, the indicator on main board will display as below:
	db	ON	12	ON	AE	ON	Confirmation of startup of the unit. After displaying for 2s, the system will select "15_cooling debugging operation" or "16_heating debugging operation" automatically according ambient temperature to start up operation. If it needs to add refrigerant because of engineering requirement while the refrigerant hasn't been added finished before debugging, refrigerant can be added through low-pressure detection valve during operation process.
15_ Debugging operation for cooling	db	ON	15	ON	AC	ON	Debugging under cooling mode. If there's no malfunction after the compressor operates for 20min, it will enter into process 17 to finish debugging; If there's malfunction during operation process, the display is as below:
	db	ON	15	ON	Corresponding error code	ON	There's malfunction during debugging process under cooling mode. After removing all malfunctions, it will enter into the next step determination.

Stage process instruction for debugging							Code instruction and operation method
—	Debugging code		Process code		Status code		
Process	LED1		LED2		LED3		
	Code	Display status	Code	Display status	Code	Display status	
16_ Debugging operation for heating	db	ON	16	ON	AH	ON	Debugging under heating mode. If there's no malfunction after the compressor operates for 20min, it will enter into process 17 to finish debugging; If there's malfunction during operation process, the display is as below:
	db	ON	16	ON	Corresponding error code	ON	There's malfunction during debugging operation under heating mode. The unit will enter into the next step determination after eliminated all malfunctions.
17_ Finished status of debugging	00	ON	AC/AH	ON	OF	ON	Debugging is finished for the complete unit. The system is at standby status.

1.3 Parameters reference value for the normal operation of unit

No.	Debugging project		Parameters name	Unit	Reference value
1	Parameters of system	Parameters of outdoor unit	Outdoor ambient temperature	℃	—
2			Discharge temperature of compressor	℃	<ul style="list-style-type: none"> After compressor is started up, normal discharge temperature for cooling is 70~105℃, which is 10℃ above more than the high pressure saturation temperature. The normal temperature for heating is 65℃~90℃, which is 10℃ above more than the high pressure saturation temperature.
3			Defrosting temperature	℃	<ul style="list-style-type: none"> During cooling operation, defrosting temperature is 4~10℃ lower than the high pressure value of system; During heating operation, defrosting temperature is almost equal to the low pressure value of system (the difference is within 2℃).
4			High pressure of system	℃	<ul style="list-style-type: none"> Under cooling mode, the normal high pressure value is 20℃~55℃. According to the change of ambient temperature and operation capacity of system, the high pressure value of system is 10℃~30℃ higher than the ambient temperature. The higher the ambient temperature, the temperature difference is small; Under cooling operation at the ambient temperature of 25~35℃, the high pressure value for the system is 44~53℃; The unit will operate at heating mode when the ambient temperature is above -5℃. The high pressure value for the system is 40~52℃. When the ambient temperature is low and the indoor unit is started up frequently, the high pressure value will be a little lower.
5			Low pressure of system	℃	<ul style="list-style-type: none"> The unit will operate under cooling mode when the ambient temperature is 25~35℃, the low pressure value for the system is 0~8℃. The unit will operate under heating mode when the ambient temperature is above -5℃, the low pressure value for the system is -15~8℃.
6			Opening angle of electronic expansion valve for heating	PLS	<ul style="list-style-type: none"> During cooling operation, the electronic expansion valve for heating will always be kept at 480PLS; During heating operation, the opening angle for the adjusted electronic expansion valve is 55~480PLS.
7			Operation frequency for compressor	HZ	Change among 10HZ~95HZ
8			Operation current of compressor	A	Current should be no more than 25.0A during normal operation for compressor

No.	Debugging project	Parameters name	Unit	Reference value
9		IPM module temperature for compressor	°C	When ambient temperature is lower than 35°C, temperature for IPM module is lower than 80°C. The maximum temperature won't exceed 95°C.
10		Operation frequenc for fan	HZ	It will adjust the frequency among 0~49HZ for operation according to the system pressure
11		Ambient temperature for indoor unit	°C	—
12		Entry tube temperature for indoor heat exchanger	°C	<ul style="list-style-type: none"> ●According to the difference of ambient temperature, the entry tube temperature is 1°C~7°C lower than the exit tube temperature for the same indoor unit under cooling mode; 4~9°C higher than low pressure. ●Under heating mode, entry temperature is 10°C~20°C lower than exit tube temperature for the sae indoor unit.
13		Entry tube temperature for indoor heat exchange	°C	
14		Opening angle of indoor electrocnic expansion valve	PLS	Under cooling mode, the opening angle for indoor electronic expansion valve is adjusted among 70~480PLS. Under heating mode, the opening angle for indoor unit is adjusted among 40~480PLS.
15	Communication paraters	Communication data	—	Through debugging software, it detected that the quantity of indoor unit is same with the engineeringr actual quantity. There's no communication malfunction.
16	Drainage syste	—	—	Water can be drained smoothly for indoor unit; Outdoor unit can drain water fromo drainage pipe completely.
17	Other	—	—	

2 Malfunction List

2.1 Malfunction list for the wired controller

Display code	Content	Display code	Content	Display code	Content
L0	Malfunction of indoor unit	L9	Wrong number of indoor unit for one-to-more indoor unit	d8	Malfunction of water temperature sensor
L1	Indoor fan protection	LA	Wrong series for one-to-more indoor unit	d9	Malfunction of jumper cap
L2	E-heater protection	LH	Alarming due to bad air quality	dA	Abnormal address for indoor unit
L3	Water overflow protection	LC	The indoor unit model can't match with outdoor unit model	dH	Abnormal PCB for wired controller
L4	Power supply of wired controller is faulted	d1	Poor indoor PCB	dC	Abnormal code-dialing setting of capacity
L5	Freeze prevention protection	d3	Malfunction of ambient temperature sensor	dL	Malfunction of air exhause temperature sensor
L6	Mode shock	d4	Malfunction of entry tube temperature sensor	dE	Malfunction of indoor C02 sensor
L7	No main indoor unit	d6	Malfunction of exit tube temperature sensor	C0	Communication malfunction
L8	Insufficient power supply	d7	Malfunction of humidity sensor	AJ	Clean alarming for filter
db	Special code: engineering debugging code				

2.2 Status display table for indicators on main board of outdoor unit

Definition:

- LED1: It displays “00” for hot water mode as for DC Inverter Side Discharge VRF
- LED2: It displays “AC” for AC mode, cooling and cooling OFF mode for indoor unit, and displays “AH” for heating and heating OFF mode for indoor unit
- LED3: It displays on or off status of compressor and malfunction code. It displays “ON” when the compressor is operating and “OFF” when the compressor stops operation. When there’s malfunction for the unit, it will display corresponding malfunction code; when there’re multiple malfunctions, the malfunction codes will be displayed in turn.

Display code table of outdoor unit is as below:

Display code	Content	Display code	Content	Display code	Content
E0	Malfunction of outdoor unit	E1	High pressure protection	E2	Low-temperature protection for discharge
E3	Low pressure protection	E4	Discharge high temperature protection for compressor	EC	Loose protection for discharge temperature sensor for compressor 1
F0	Poor main board of outdoor unit	F1	Malfunction of high pressure sensor	F3	Malfunction of low pressure sensor
F5	Malfunction of discharge temperature sensor for compressor 1	FP	Malfunction of DC motor	J0	Other module protection
J1	Overcurrent protection for compressor 1	J7	Air-mixing protection for 4-way valve	J8	High pressure ratio protection of system
J9	Low pressure ratio protection of system	JL	High pressure is too low	b1	Malfunction for outdoor ambient temperature sensor
b2	Malfunction of defrosting temperature sensor 1	b3	Malfunction of defrosting temperature sensor 2	b4	Malfunction of liquid temperature sensor for subcooler
b5	Malfunction of gas temperature sensor for subcooler	b6	Malfunction for temperature sensor of inlet tube of gas and liquid separator	b7	Malfunction for temperature sensor of exit tube of gas and liquid separator (exit tube A)
b9	Malfunction of gas exit temperature sensor for heat exchanger	bH	Abnormal clock of system	P0	Malfunction driven board for compressor
P1	Driven board of compressor works abnormally	P2	Power voltage protection for the driven board of compressor	P3	Reset protection for the driven module of compressor
P4	Driven PFC protection of compressor	P5	Overcurrent protection for inverter compressor	P6	Driven IPM module protection for compressor
P7	Malfunction of driven temperature sensor for compressor	P8	Overheating protection for driven IPM of compressor	P9	Desynchronizing protection for inverter compressor
PH	High voltage protection for driven DC bus bar of compressor	PC	Circuit malfunction of driven current detection for compressor	PL	Low voltage protection for driven DC bus bar of compressor
PE	Phase-losing of inverter compressor	PF	Malfunction of driven charging loop for compressor	PJ	Failure start up for inverter compressor
PP	AC current protection for inverter compressor	U0	Preheat time is not enough for compressor	U2	Capacity code of outdoor unit/wrong setting of jumper cap
U4	Insufficient refrigerant protection	U5	Wrong address for the driven board of compressor	U6	Alarm due to abnormal valve
U8	Malfunction of pipeline for indoor unit	U9	Malfunction of pipeline for outdoor unit	UC	Setting for indoor unit and outdoor unit is succeeded
UL	Wrong code-dialing during emergency	UE	Refrigerant-charging is invalid	C0	Communication malfunction for indoor unit,

Display code	Content	Display code	Content	Display code	Content
	operation				outdoor unit and wired controller of indoor unit
C2	Driven communication malfunction between main board and inverter compressor	C3	Driven communication malfunction between main board and inverter compressor	C4	Malfunction of indoor unit-lacking
C5	Alarming due to engineering series number shock of indoor unit	C6	Alarming due to wrong quantity of outdoor unit	C8	Emergency status of compressor
C9	Emergency status of fan	CH	High rated capacity	CC	No malfunction of main control unit
CA	Emergency status of module	CF	Malfunction of main control unit	CJ	Address shock of system
CL	Low rated capacity	CU	Communication malfunction between indoor unit receiving lamp board	Cb	Distribution overflow of Ip address
A0	Debugging for unit	A1	Operational parameter inquiry of compressor	A2	Refrigerant recovery
A3	Defrosting	A4	Oil return	A5	On-line test
A6	Heat pump function setting	A7	Quit mode setting	A8	Vacuum pump mode
A9	IPLV test	AU	Long-distance emergency stop	Ab	Emergency stop
AA	EU AA class energy efficiency test mode	AH	Heating	AL	Charge refrigerant automatically
AE	Charge refrigerant by hand	AF	Fan blow	AJ	Cleaning alarm for filter
AP	Startup debugging confirmation of unit	Ad	Limit operation	n0	SE setting for the operation
n1	Defrosting period K 1 setting	n2	Upper limit setting for the collocation matching ratio for indoor unit and outdoor unit	n4	Limit setting for the maximum output capacity
n6	Engineering series number inquiry for indoor unit	n7	Malfunction inquiry	n8	Parameters inquiry
nH	Heating only model	nC	Cooling only model	nA	Heat pump unit
nF	Fan model	nE	Negative code	Ed	Low temperature protection for drive module

3 Troubleshooting

Troubleshooting principle

1) Communication malfunction

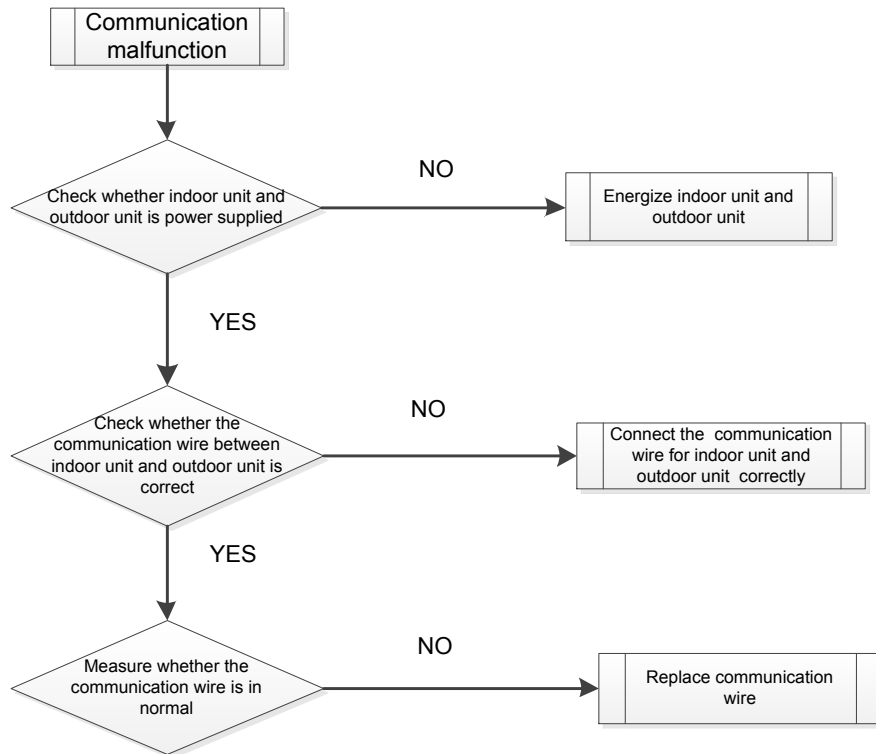

2) High pressure protection

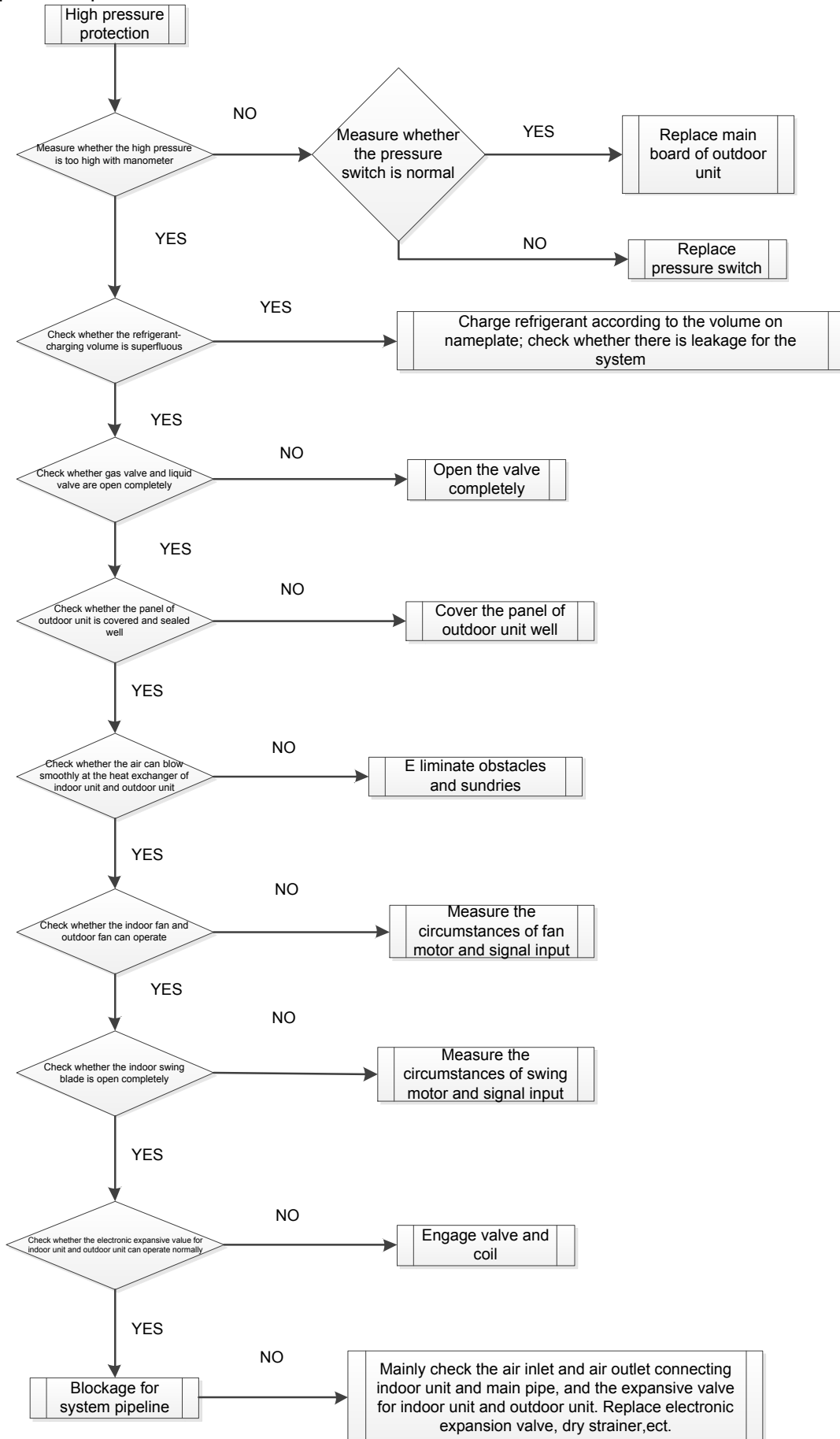

3) Low-pressure protection

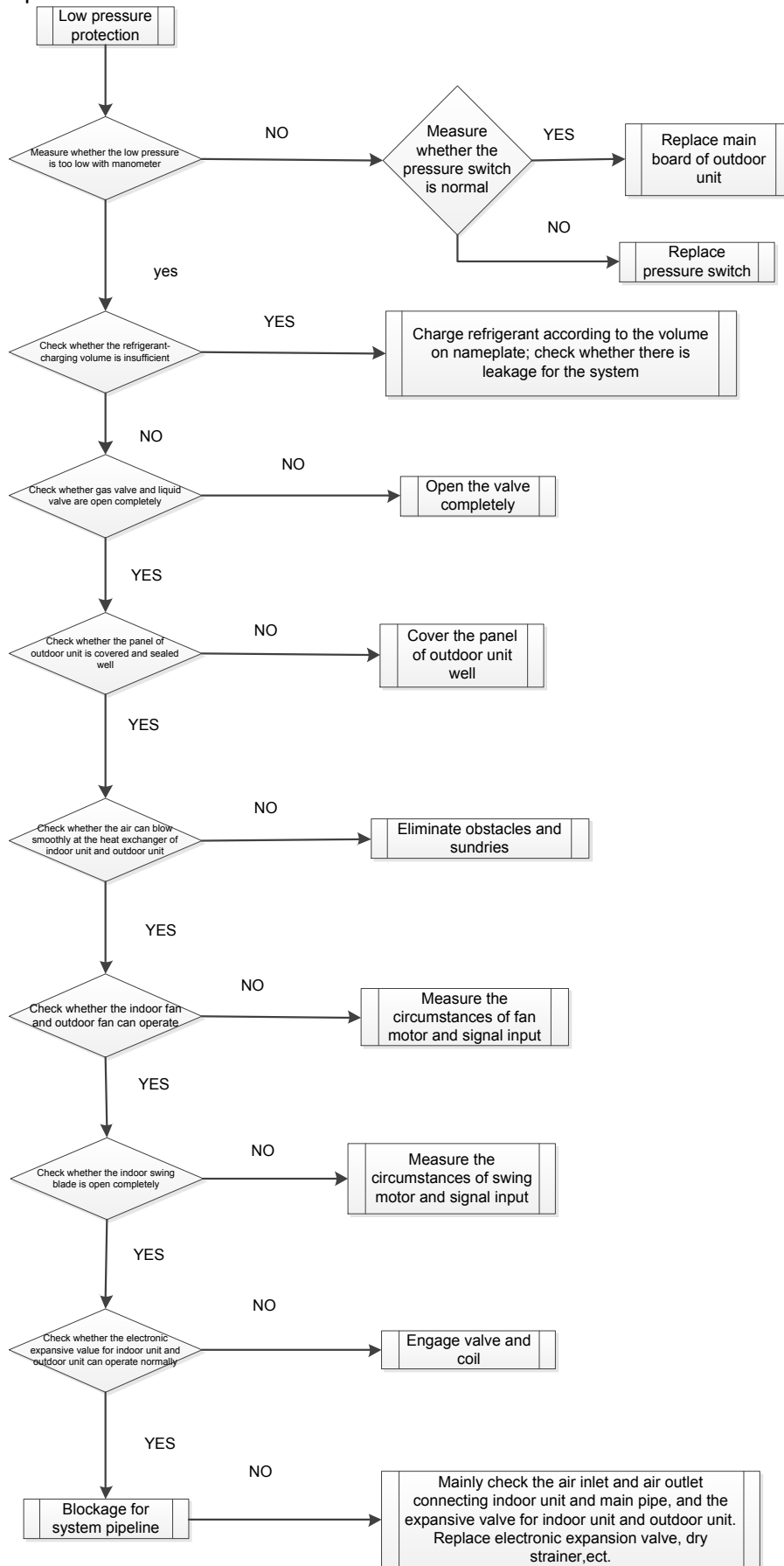

4) Discharge temperature protection

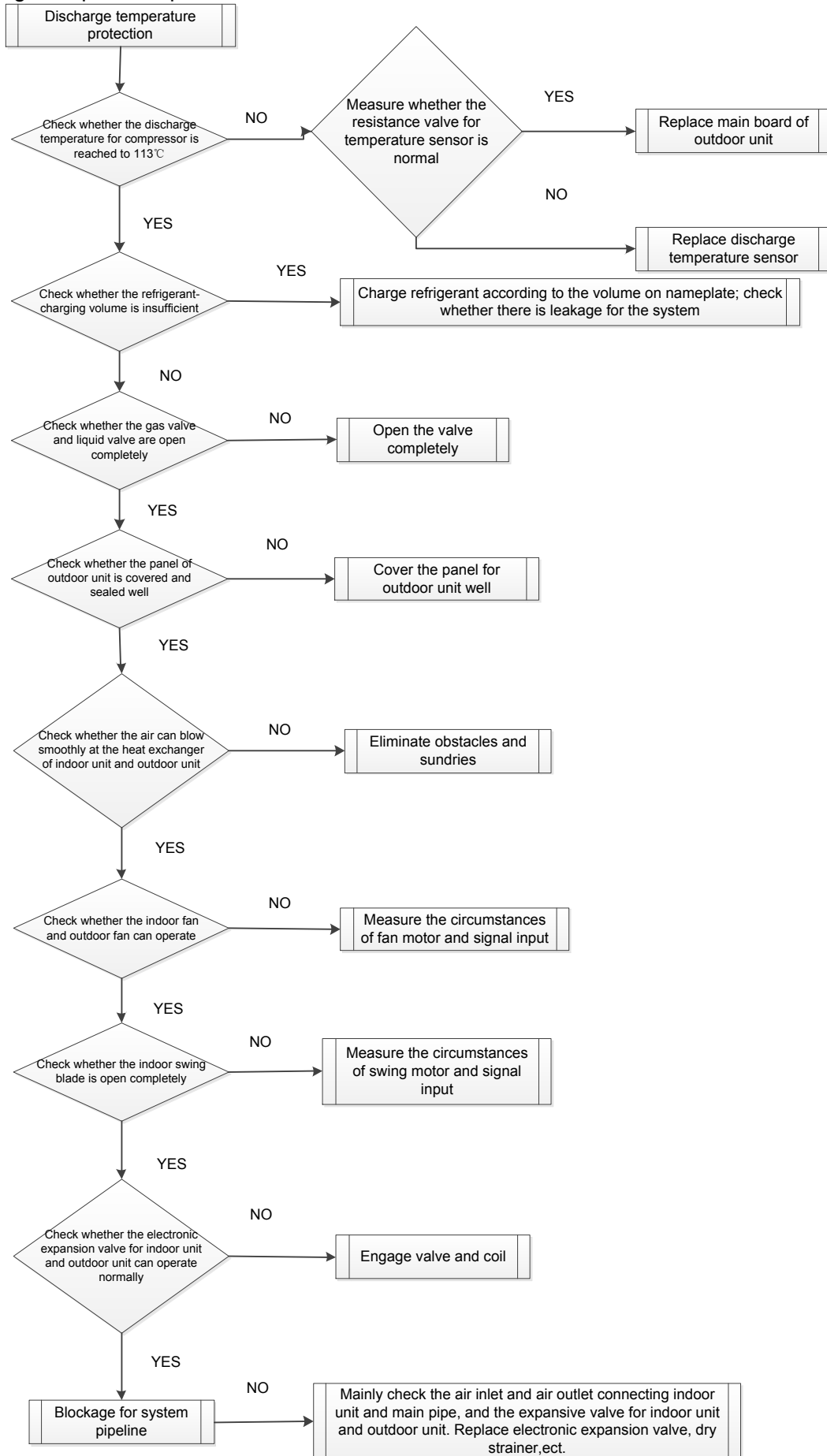

5) Malfunction of temperature sensor

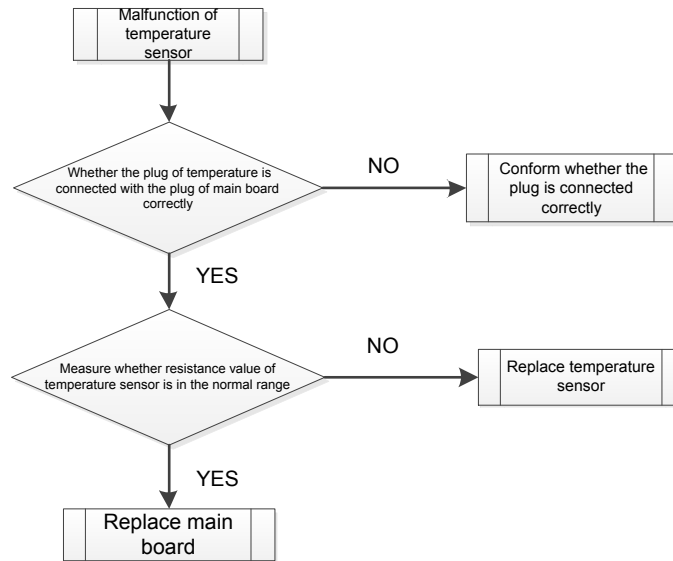

6) Malfunction of sensor

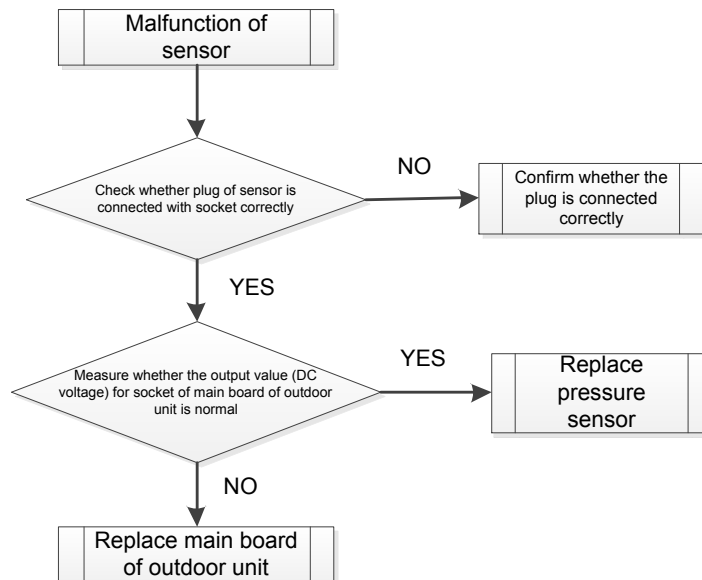

7) Unit and main board can't be energized

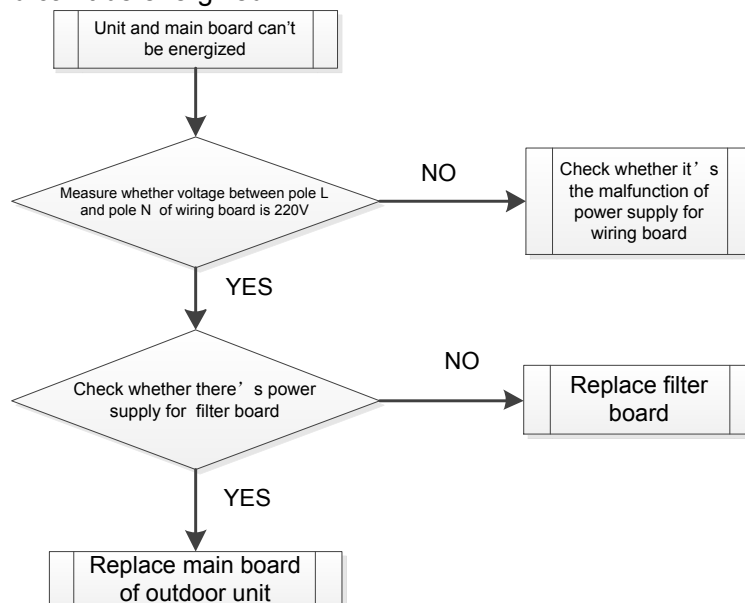

8) Failure start-up

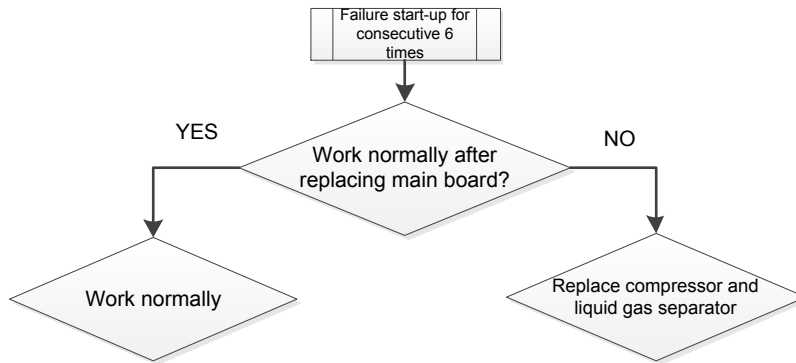

9) Reset protection for drive module of compressor, drive PFC protection for compressor, malfunction of drive temperature sensor for compressor, circuit malfunction of drive current detection for compressor

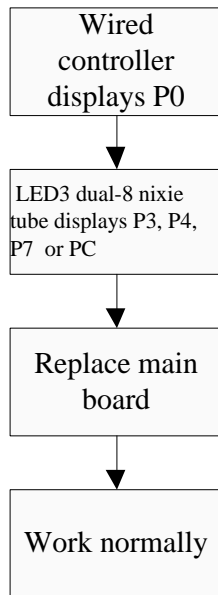

10) Drive IPM overtemperature protection for compressor

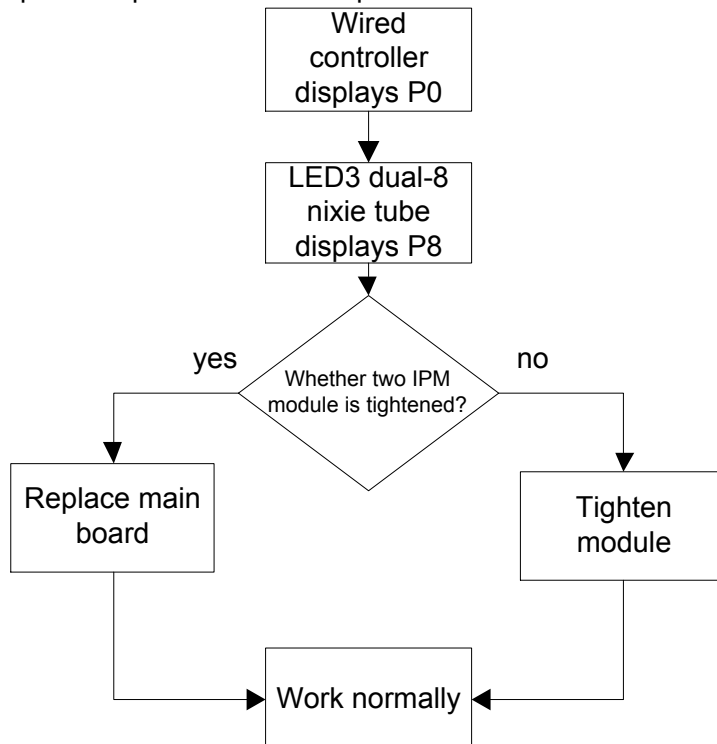

11) Desynchronizing protection for inverter compressor

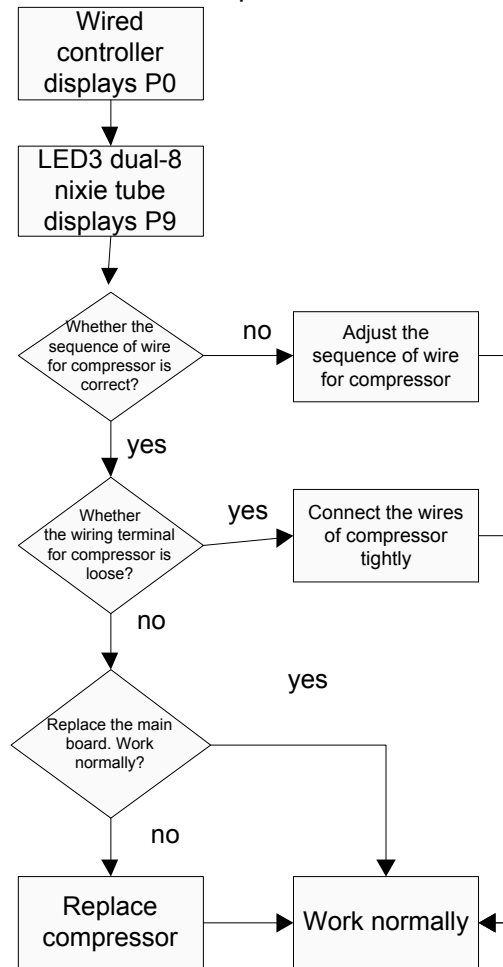

12) Failure startup for inverter compressor

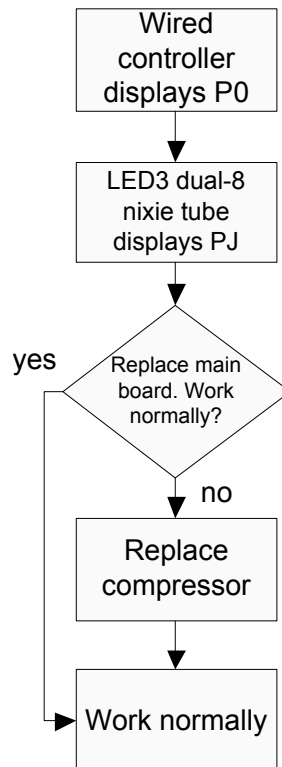

13) Loop malfunction of driven charging for compressor

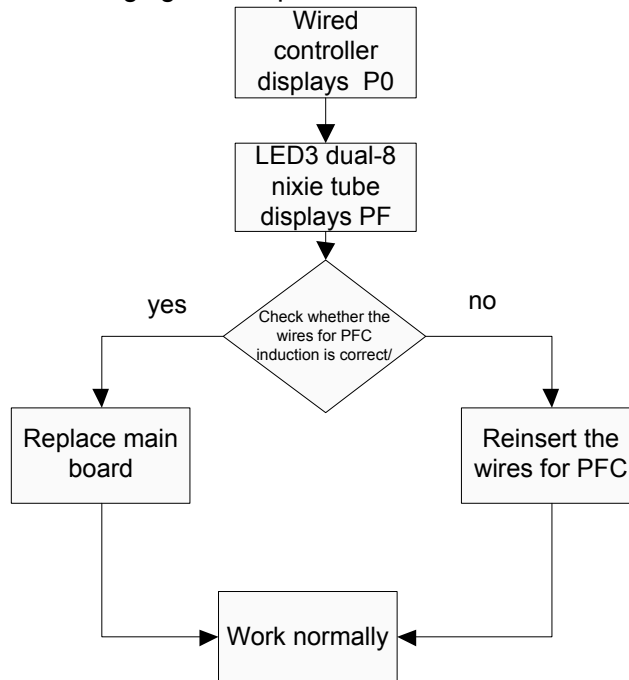

14) Malfunction of memory chip for inverter compressor

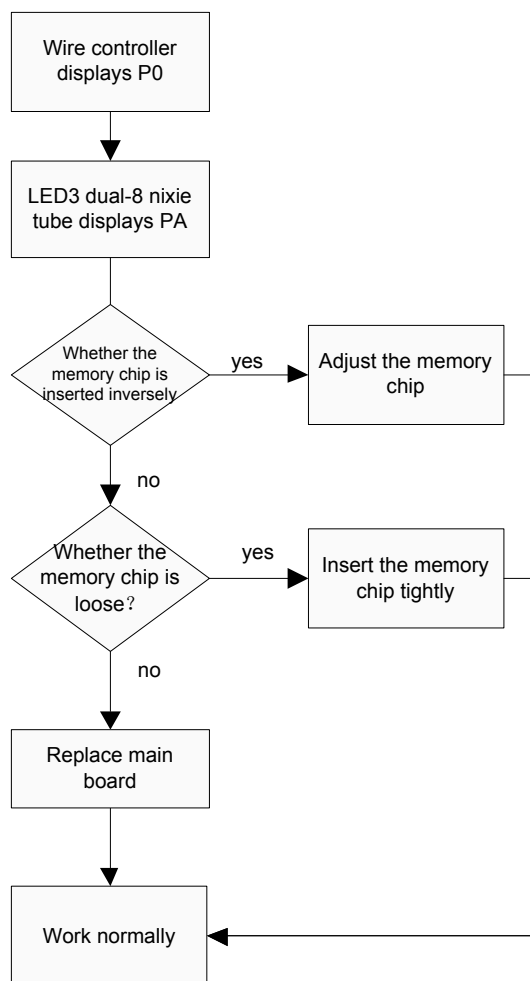

15) Overcurrent protection for inverter compressor, IPM module protection, phase-lacking of inverter compressor

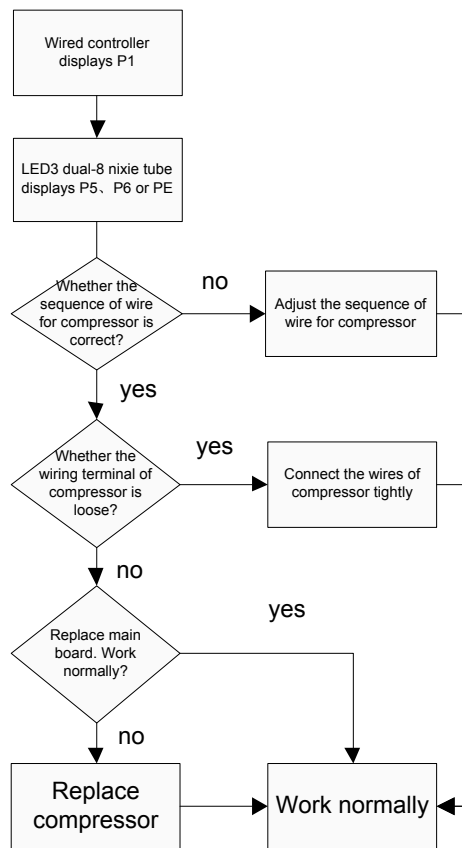

16) High pressure protection for driven DC bus bar of compressor, low pressure protection for driven DC bus bar of compressor

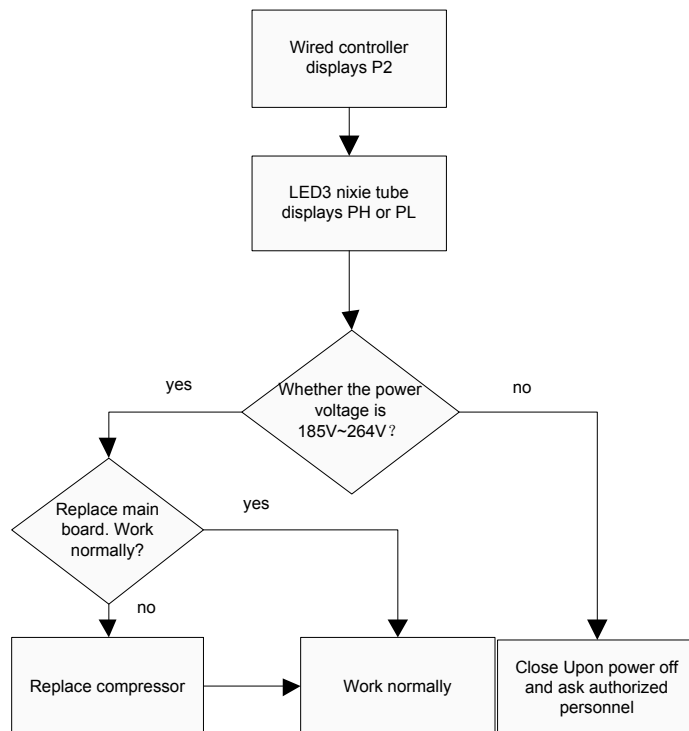

17) AC current protection for inverter compressor

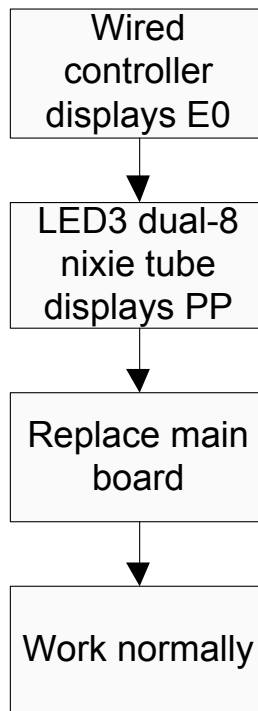

18) Communication malfunction between main controller and driver of inverter compressor

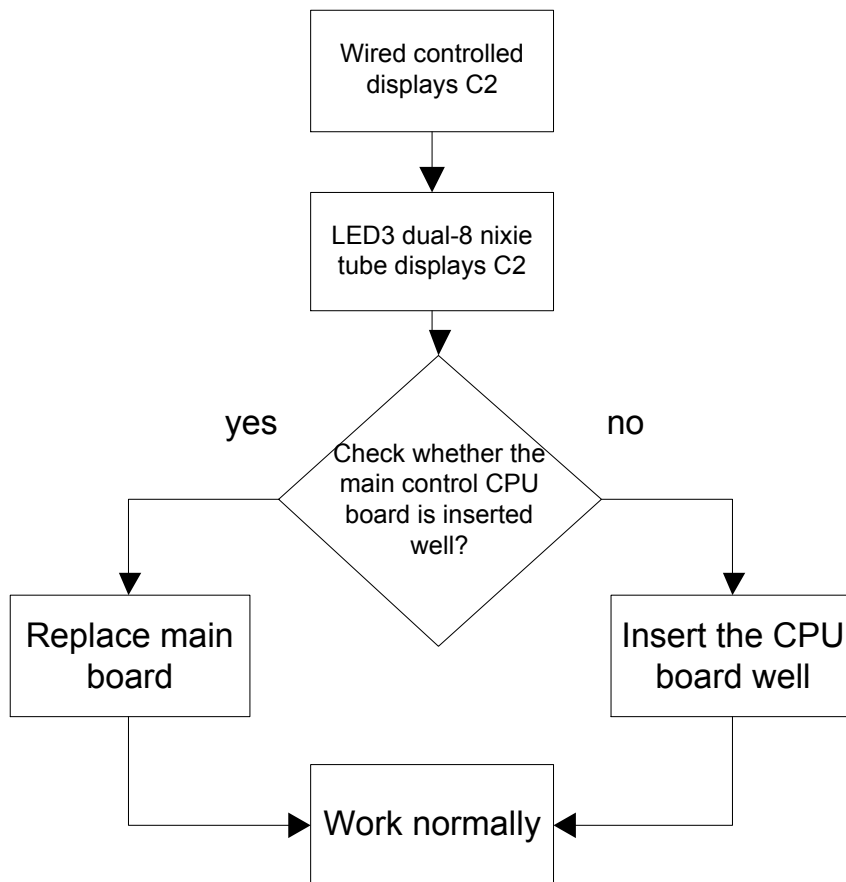

4 Power Distribution of Unit

4.1 Power distribution of unit

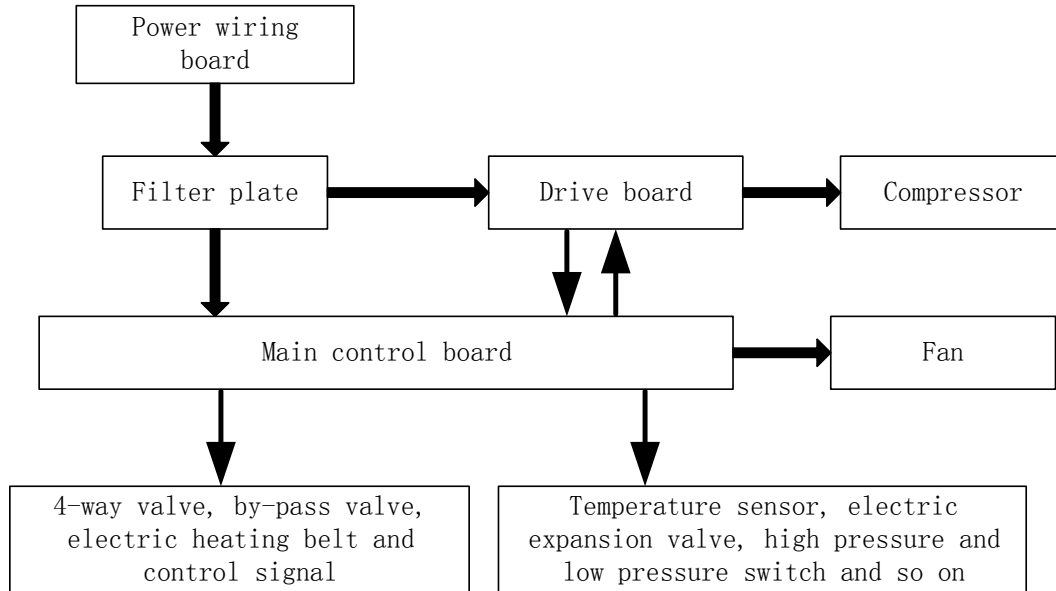

The control logical relationship among parts inside the electric box of unit is showed by the mongline diagram (CAD source file).

The main loop is showed by bold line (line width: 1mm); the control loop is showed by slim line (line width: 0.2mm).

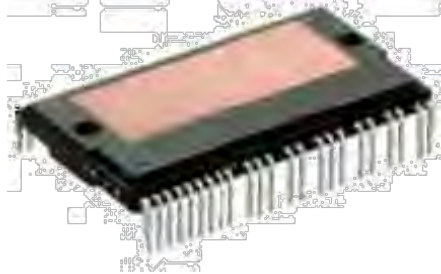

(Bold line is the power line and the slim line is the control line)

4.2 Main electric parts

Name	Photo	Function introduction
Filter plate		It main effect is to eliminate the interference of power for protecting unit's anti-interference capability and prevent the interference to other electric appliances.
IPM Module		There are three complementary IGBT tube inside the IPM module. They are controlled by PWM wave and then bring the pressure of DC bus bar to different stator windings of compressor at different stage, and then generate current on the stator. Meanwhile, magnetic field will be generated on the stator winding, and push the operation of rotor and then drive compressor to operate.
PFC module		Four diodes and two MOS pipe are intergrated inside the PFC module. It will transform AC input power into DC power. Meanwhile, MOS pipe is controlled by PWM wave. Pressure will be increased by induction.

4.3 Circuit diagram

Circuit diagram of outdoor unit

(The following are for reference only, the circuit diagram can be found on the unit)

GMV-80WL/A-T, GMV-100WL/A-T, GMV-121WL/A-T, GMV-80WL/C-T, GMV-100WL/C-T, GMV-121WL/C-T

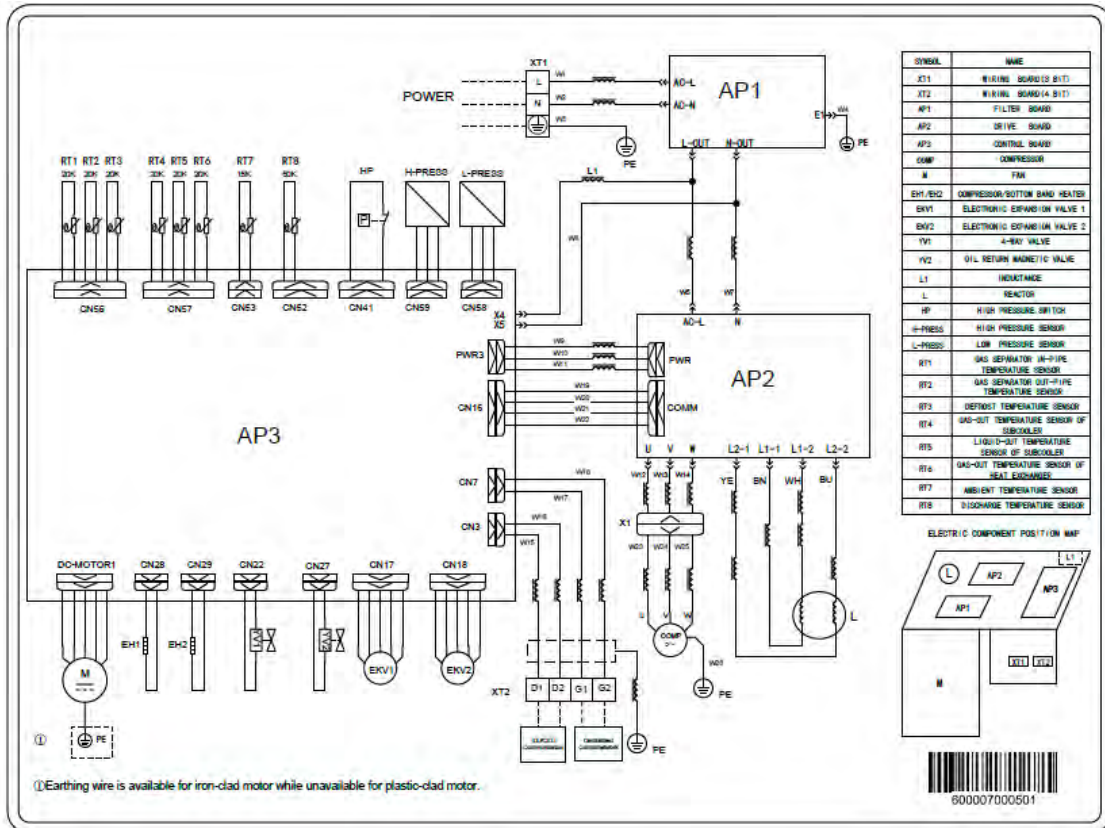

GMV-120WL/A-T, GMV-140WL/A-T, GMV-160WL/A-T

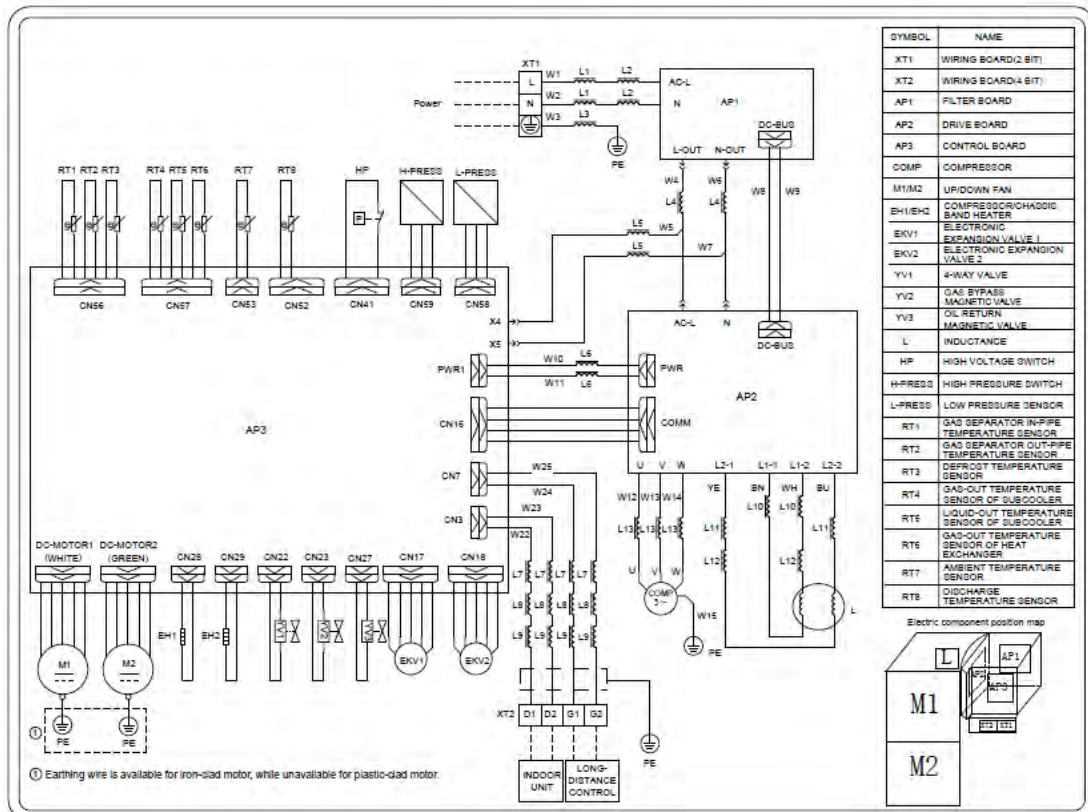

GMV-120WL/A-X, GMV-140WL/A-X, GMV-160WL/A-X

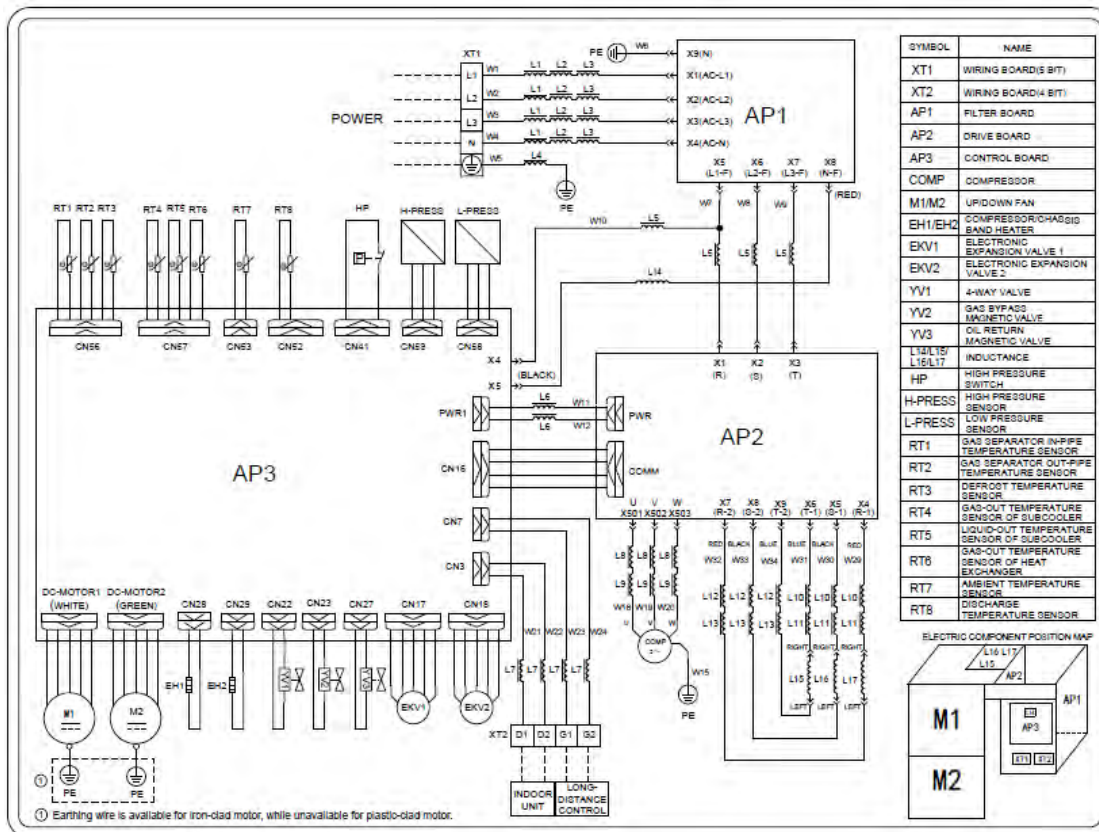

GMV-120WL/C-T, GMV-140WL/C-T, GMV-160WL/C-T

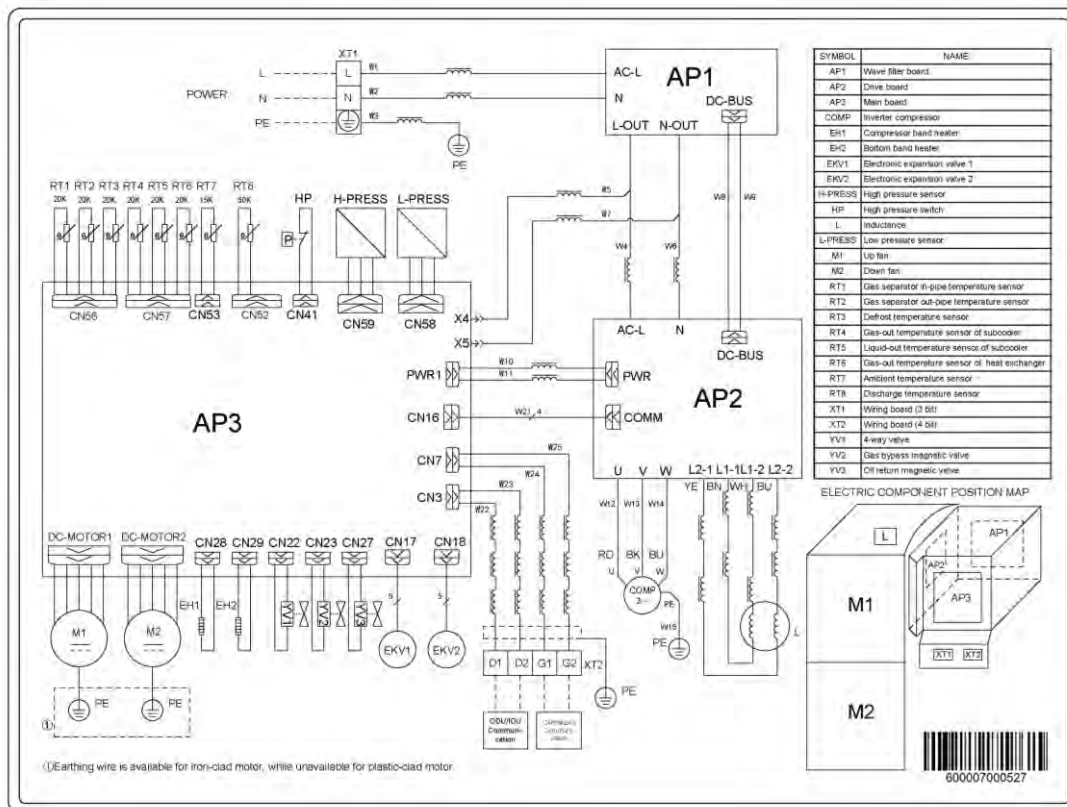

GMV-120WL/C-X,GMV-140WL/C-X,GMV-160WL/C-X

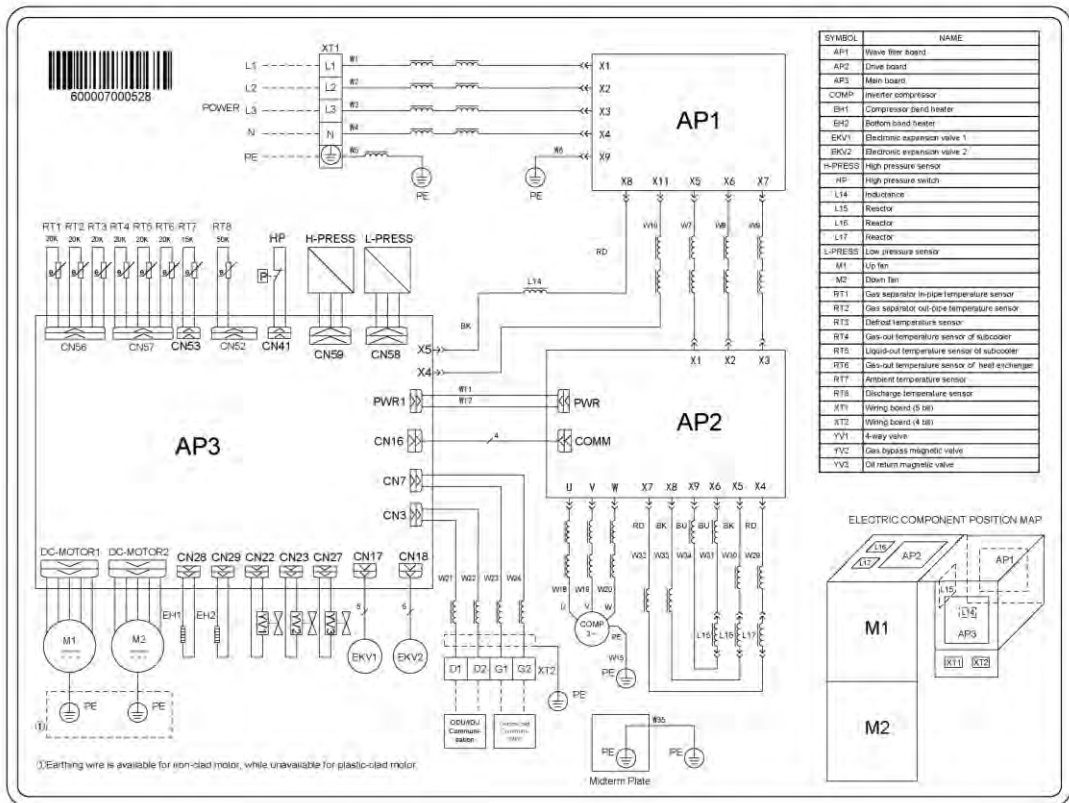

GMV-H224WL/A-X,GMV-224WL/C-X:

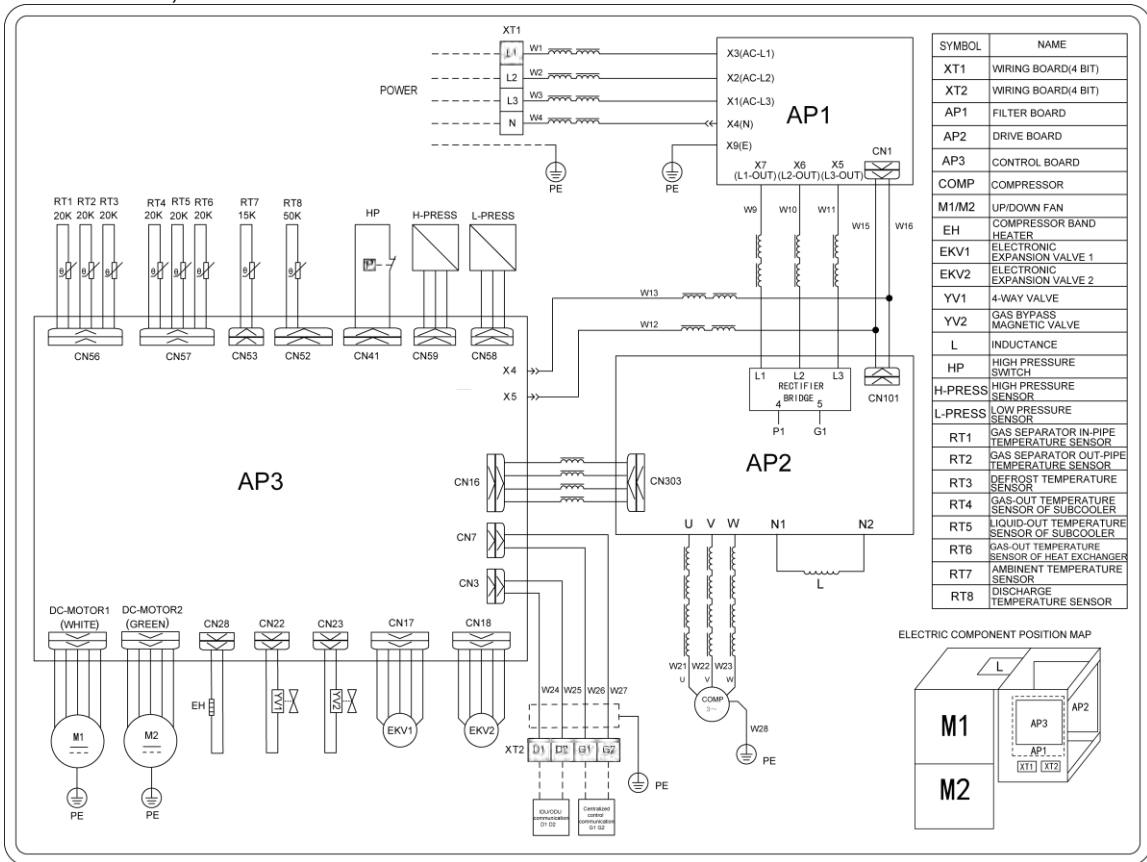

GMV-H280WL/A-X, GMV-280WL/C-X:

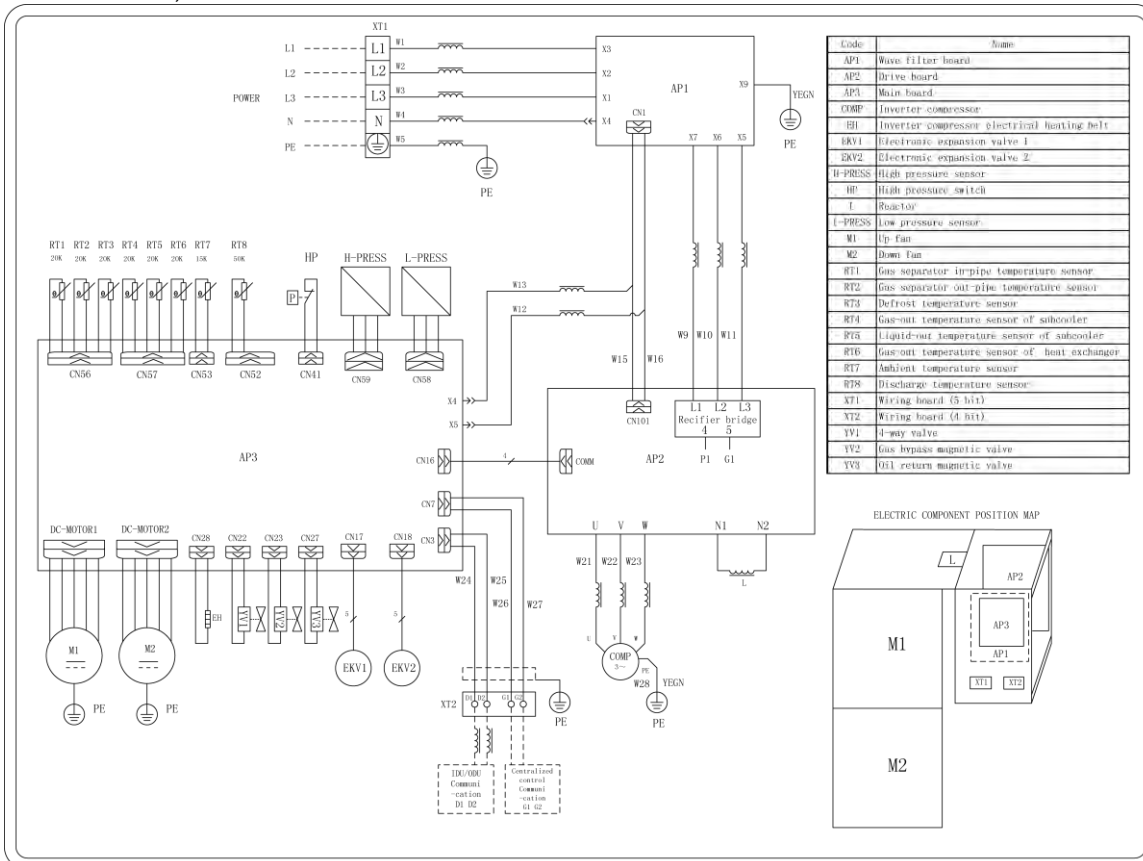

GMV-H335WL/A-X, GMV-335WL/C-X:

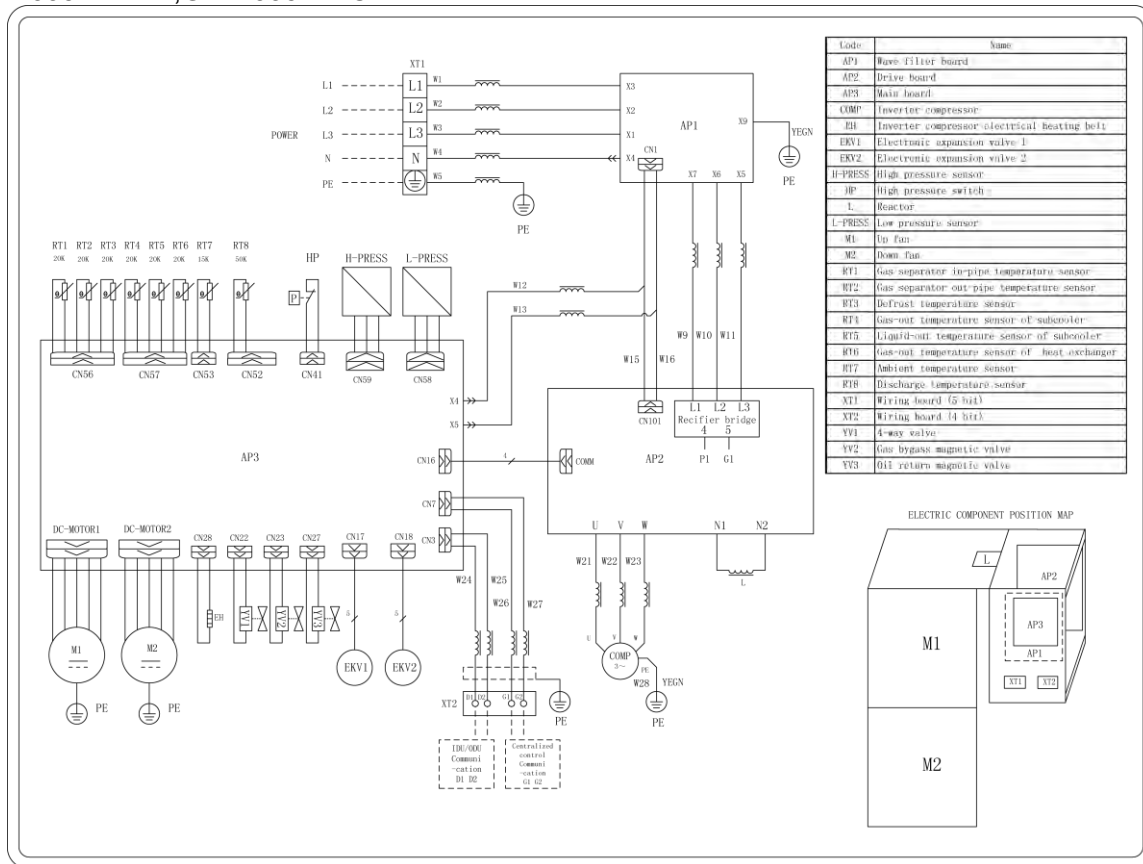

5 Removal of Parts

5.1 Key parts

Photo	Name	Function
	compressor	Core part of air conditioning system. It sucks low temperature and low pressure gas, compress it to high temperature and high pressure gas, and then discharge it.
	Electronic expansion valve	Throttling device. It transforms high pressure refrigerant liquid into low pressure steam.
	4-way valve	It changes the flow direction of refrigerant for switching between cooling and heating.
	Oil separator	It stays between discharge outlet of compressor and inlet of condenser. It used for separating the lubricant oil of compressor when the high temperature and high pressure refrigerant gas is discharged from the compressor.

Photo	Name	Function
 <p>A vertical cylindrical component with a U-shaped bottom section. It has two ports at the top and a single port at the bottom. The internal structure is designed to separate vapour from liquid refrigerant.</p>	<p>Vapour liquid separator</p>	<p>It stays between outlet of evaporator and suction outlet of compressor. It used for separating low temperature and low pressure refrigerant.</p>
 <p>A vertical cylindrical tank with two ports at the top. It is designed to store excess high-pressure liquid refrigerant during the cooling cycle.</p>	<p>High pressure liquid storage tank</p>	<p>It used for storing the superfluous high pressure refrigerant liquid during cooling process.</p>
 <p>A valve with a vertical stem and a horizontal outlet. A downward-pointing arrow on the stem indicates the direction of flow when the valve is open.</p>	<p>Solenoid valve</p>	
 <p>A valve with a T-shaped body and a curved handle. It is used to isolate sections of the refrigerant system for maintenance or installation.</p>	<p>Cut-off valve</p>	<p>It used for connecting indoor unit and outdoor unit, and used for maintenance and installation.</p>

5.2 Removal of key parts

5.2.1 GMV-120WL/A-T, GMV-140WL/A-T, GMV-160WL/A-T , GMV-120WL/A-X,GMV-140WL/A-X,GMV-160WL/A-X,GMV-120WL/C-T,GMV -140WL/C-T,GMV-160WL/C-T, GMV-120WL/C-X,GMV-140WL/C-X,GMV-160WL/C-X, GMV-H224WL/A-X, GMV-H280WL/A-X, GMV-H335WL/A-X , GMV-224WL/C-X,GMV-280WL/C-X,GMV-335WL/C-Xseries unit

Removal operation for panel		
Remark: Before removing the panel, please make sure that the unit is disconnected with the power		
Process	Photo	Operation Instruction
1)Remove top cover		<ul style="list-style-type: none"> • Loose the screws fixing the top cover with screwdriver • Hold the top cover upwards and then put it on the floor flatly
2)Remove front side plate sub-assy		<ul style="list-style-type: none"> • Loose the screw fixing the front side plate with screwdriver • Hold the front side plate upwards and then put it on the floor flatly

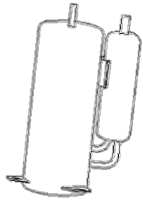
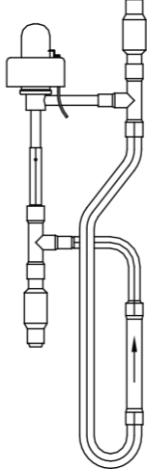
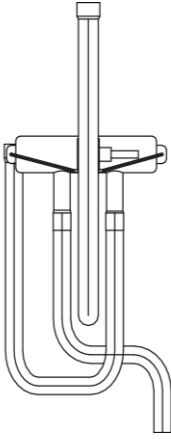
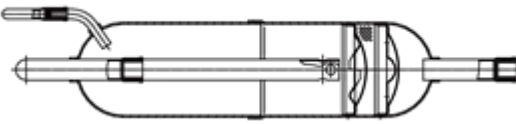
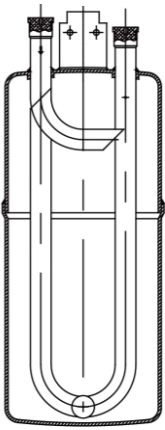
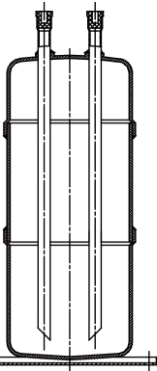
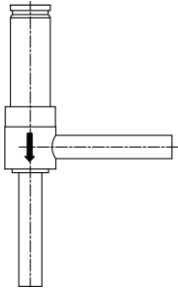
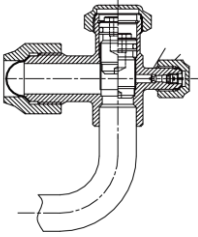
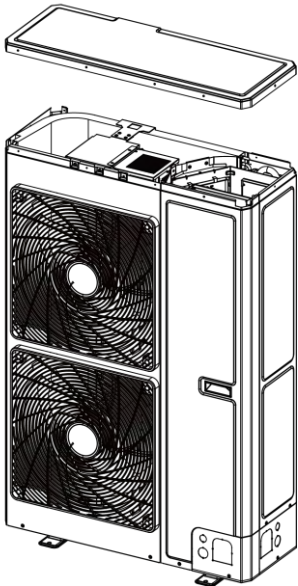
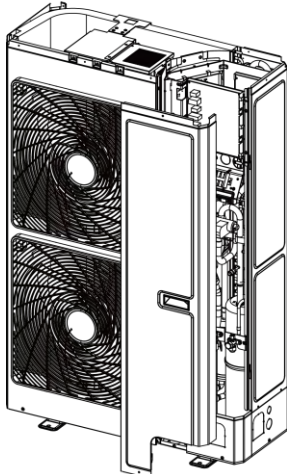
Removal operation for panel

Remark: Before removing the panel, please make sure that the unit is disconnected with the power

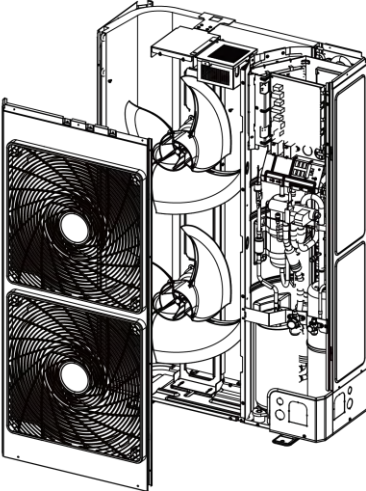
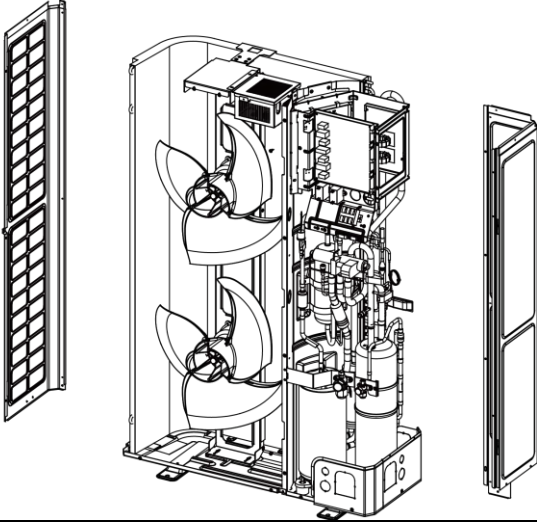
Process	Photo	Operation Instruction
<p>3) Remove front panel and grille</p>		<ul style="list-style-type: none"> ● Loose the screws fixing the front panel and grille with screwdriver ● Put the front panel and grille on the floor flatly
<p>4) Remove left side plate and rear side plate</p>		<ul style="list-style-type: none"> ● Loose screws fixing left side plate and rear side plate with screwdriver ● remove the rear side plate

Removal operation for blade

Remark: Before removing the motor, please make sure that the unit is disconnected with the power.

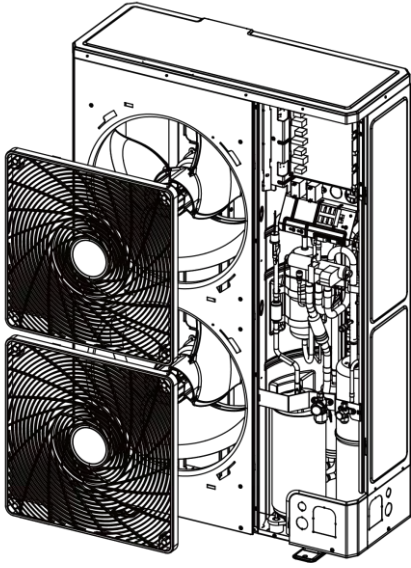
Process	Photo	Operation Instruction
<p>1) Remove grille</p>		<ul style="list-style-type: none"> ● Loose screws fixing the panel with screwdriver ● Then remove the grille

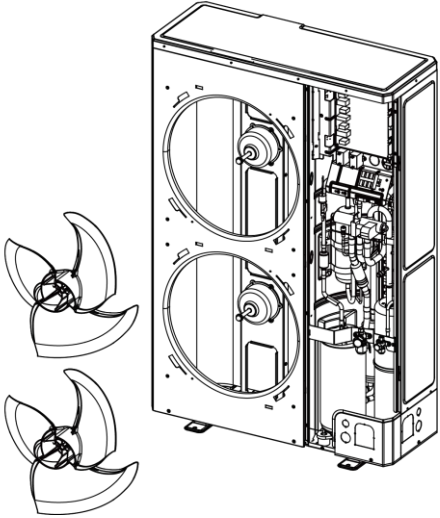
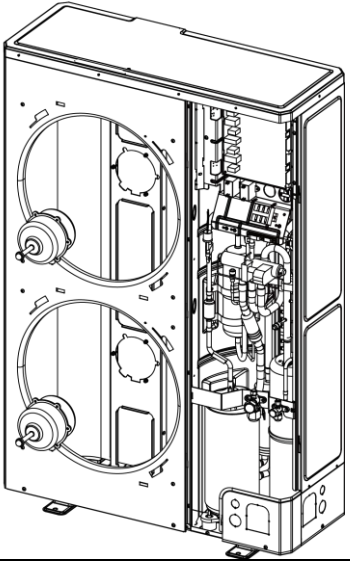
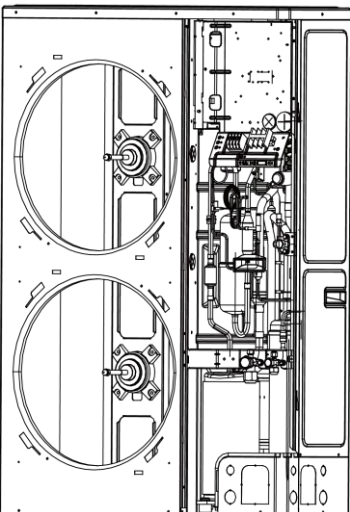
Removal operation for blade		
Remark: Before removing the motor, please make sure that the unit is disconnected with the power.		
Process	Photo	Operation Instruction
2) Remove blade		<ul style="list-style-type: none"> • Loosen nuts fixing the blade with wrench • Then remove the blade and put it on the floor flatly
3) Remove motor		<ul style="list-style-type: none"> • Loose screws fixing the motor with screwdriver • then remove the power cord of motor • Take out the damaged motor
4) Install motor		<ul style="list-style-type: none"> • Replace the motor, tighten screws with screwdriver and then connect the power cord of motor

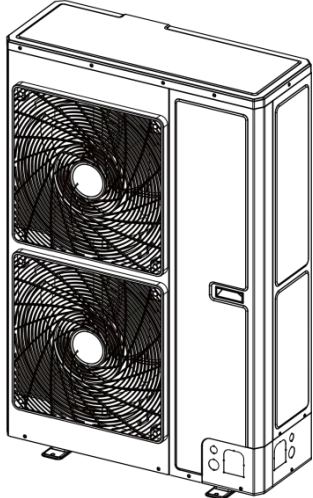
Removal operation for blade		
Remark: Before removing the motor, please make sure that the unit is disconnected with the power.		
Process	Photo	Operation Instruction
5) Assemble unit		<ul style="list-style-type: none"> Assemble the unit in the the converse sequence

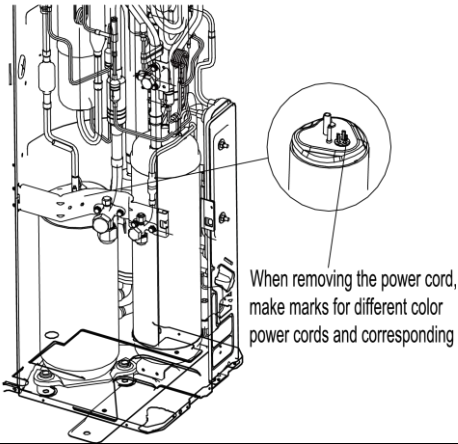
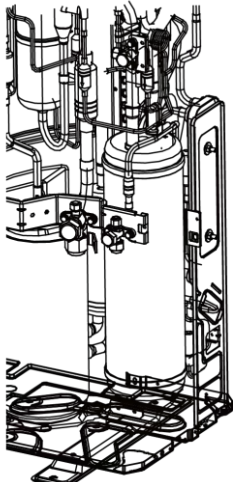
Removal operation of compressor		
Remark: Before removing the compressor, please make sure that there's no refrigerant inside the pipeline and the power is disconnected.		
Process	Photo	Operation Instruction
1) Remove wiring cover of compressor		<ul style="list-style-type: none"> Loose screws fixing the compressor with screwdriver Then pull out the power cord <p>Note: When removing the power cord, make marks for different color power cords and corresponding wiring terminals for wrong terminal.</p>
2) Disconnect compressor and connected pipeline		<ul style="list-style-type: none"> Weld suction pipe and discharge pipe of compressor then pull out the connection pipe from the compressor <p>Note: During welding process, do not let the flame burn out other parts.</p>

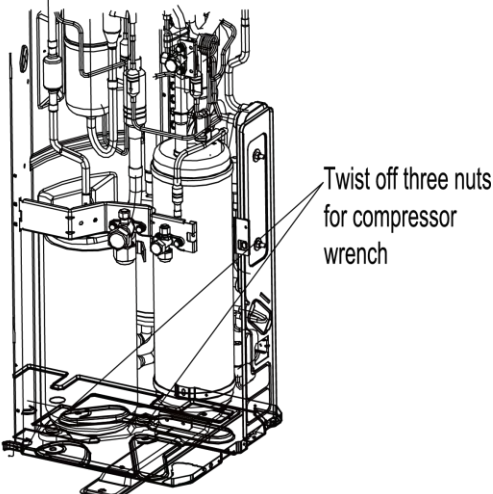
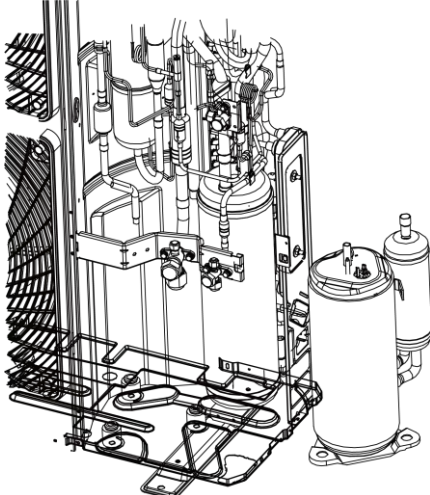
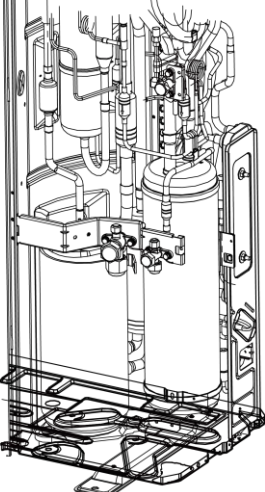
Removal operation of compressor		
Remark: Before removing the compressor, please make sure that there's no refrigerant inside the pipeline and the power is disconnected.		
Process	Photo	Operation Instruction
3) Loose nuts fixing the foot of compressor		Twist off the nuts for compressor with wrench
4)Remove the chassis from compressor		<ul style="list-style-type: none"> • Take out the compressor and replace it Note: When replacing the compressor, do not damage nearby pipelines and other parts
5)Fix the new compressor at the chassis		After replacing the compressor, fix the nuts at the bottom of compressor

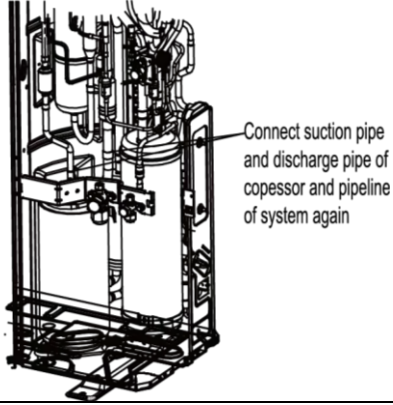
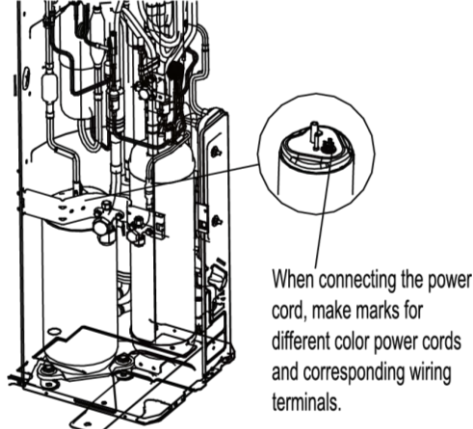
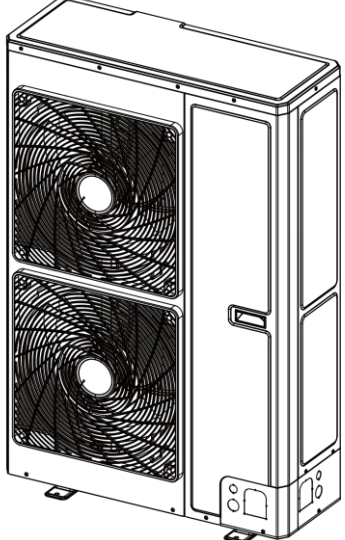
Removal operation of compressor		
Remark: Before removing the compressor, please make sure that there's no refrigerant inside the pipeline and the power is disconnected.		
Process	Photo	Operation Instruction
6) Connect suction pipe and discharge pipe of compressor and pipeline of system again		<p>Weld the connection pipe of compressor, connect the pipeline and compressor</p> <p>Note: During welding process, do not let flame burn out other parts</p>
7) Connect the power cord of compressor well		<ul style="list-style-type: none"> • Loose screws fixing the power cord with screwdriver • connect the power cord well again <p>Note: When connecting the power cord, make marks for different color power cords and corresponding wiring terminals.</p>
8) Check and open the upper cover plate		<ul style="list-style-type: none"> • Check whether the pipeline is connected well • Check whether all parts and connection wires are connected well • If there's no problem after checking, install front and rear cover plates.

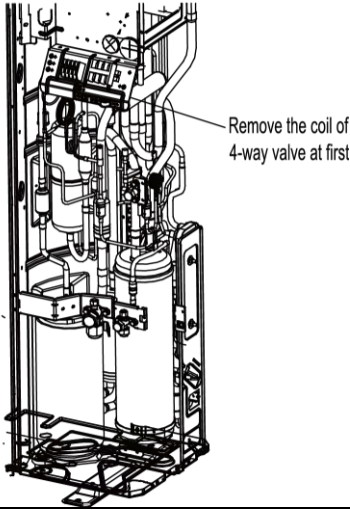
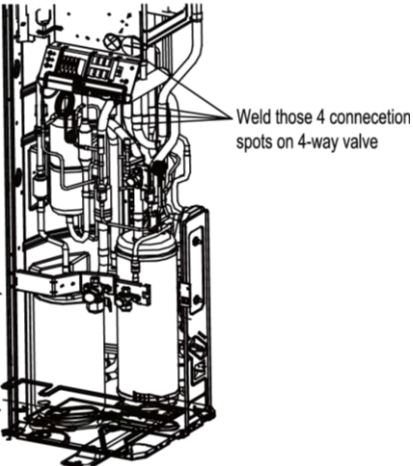
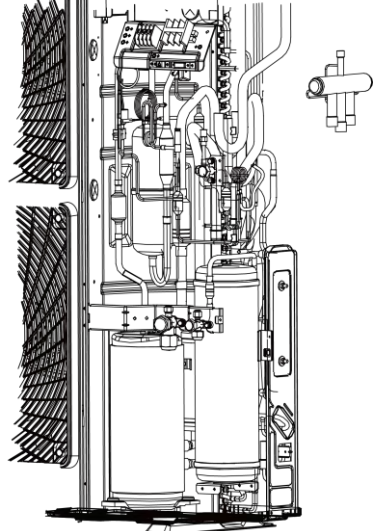
Removal operation for 4-way valve		
Remark: Before removing the 4-way valve, please make sure that there's no refrigerant inside the pipeline of system and then power is disconnected.		
Process	Photo	Operation Instruction
1) Disconnect the coil of 4-way valve from the 4-way valve		<ul style="list-style-type: none"> ● Remove the coil of 4-way valve at first
2) Disconnect the 4-way valve and connection pipeline		<ul style="list-style-type: none"> ● Weld those 4 connection spots on 4-way valve, and then pull out the connection pipe Note: During welding process, do not let the flae burn out other parts
3) Replace 4-way valve		<ul style="list-style-type: none"> ● Replace 4-way valve Note: During welding process, do not let the flame burn out other parts

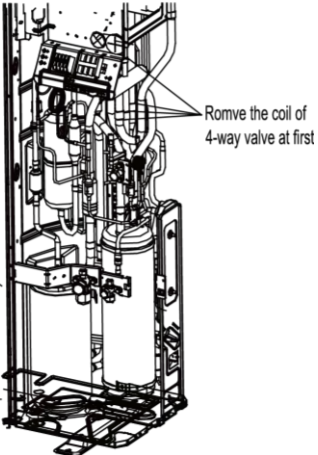
Removal operation for 4-way valve		
Remark: Before removing the 4-way valve, please make sure that there's no refrigerant inside the pipeline of system and then power is disconnected.		
Process	Photo	Operation Instruction
4)Replace 4-way valve		<ul style="list-style-type: none"> Weld the connection position between 4-way valve and pipeline <p>Note: During welding process, do not let flame burn out other parts</p>

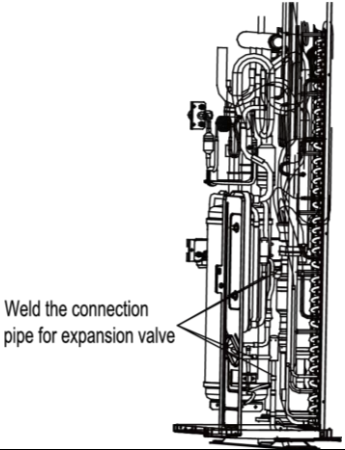
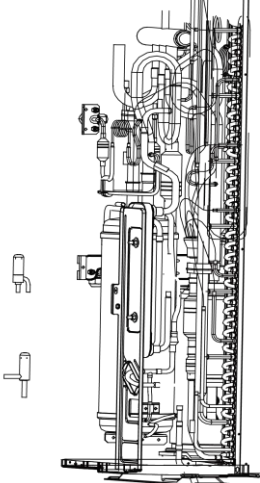
Removal operation for electronic expansion valve		
Remark: Before removing the electronic expansion valve, please make sure that there's no refrigerant in the pipeline of system and the power is disconnected		
Process	Photo	Operation Instruction
1)Disconnect the electronic expansion valve from the pipeline		<ul style="list-style-type: none"> Remove the coil of electronic expansion valve at first Weld the connection pipe for expansion valve, and then pull out the connection pipe <p>Note: During welding process, do not let flame burn out other parts</p>
2)Take out the electronic expansion valve and replace it		<ul style="list-style-type: none"> Take out the electronic expansion valve and replace it

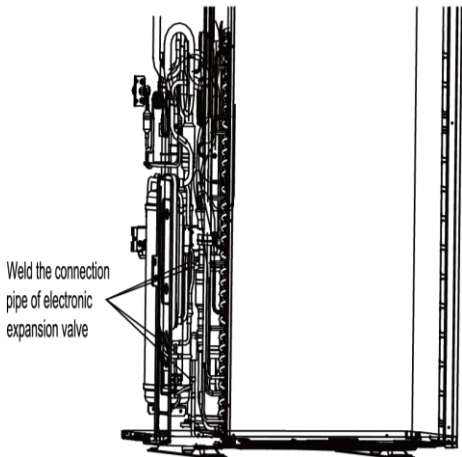
Removal operation for electronic expansion valve		
Remark: Before removing the electronic expansion valve, please make sure that there's no refrigerant in th pipeline of system and the power is disconnected		
Process	Photo	Operation Instruction
3) Replace electronic expansion valve		<ul style="list-style-type: none"> • Weld the connection pipe of electronic expansion valve • Install the coil of electronic expansion valve <p>Note: During welding process, do not let the flame burn out other parts</p>

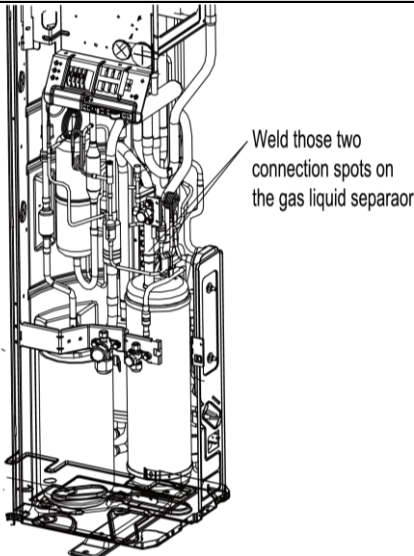
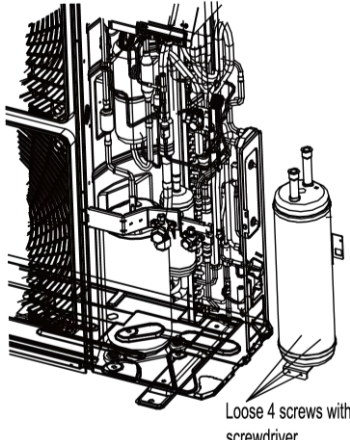
Removal operation of gas liquid separator		
Remark: Before removing the gas liquid separator, please make sure that there's no refrigerant inside the pipeline of system and disconnect the power		
Process	Photo	Operation Instruction
1) Disconnect inlet pipe and exit pipe of gas liquid separator		<ul style="list-style-type: none"> • Weld those two connection spots on the gas liquid separator and then pull out the connection pipe <p>Note: During welding process, do not let flame burn out other parts</p>
2) Replace gas liquid separator		<ul style="list-style-type: none"> • Loose 4 screws with screwdriver • Replace gas lliquid separator

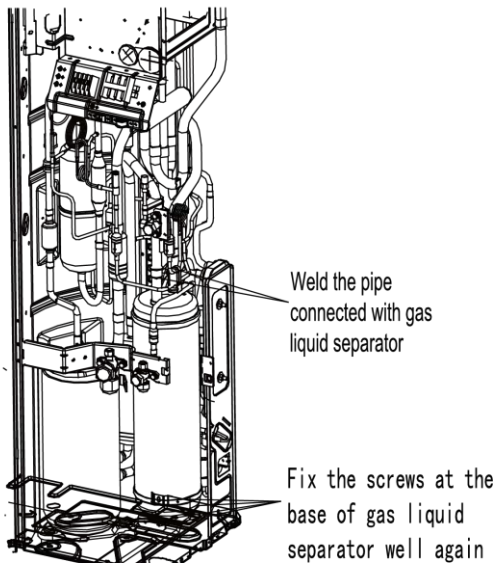
Removal operation of gas liquid separator		
Remark: Before removing the gas liquid separator, please make sure that there's no refrigerant inside the pipeline of system and disconnect the power		
Process	Photo	Operation Instruction
3) Replace gas liquid separator	 <p>Weld the pipe connected with gas liquid separator</p> <p>Fix the screws at the base of gas liquid separator well again</p>	<ul style="list-style-type: none"> • Weld the pipe connected with gas liquid separator • Fix the screws at the base of gas liquid separator well again <p>Note: During welding process, do not let flame burn out other parts</p>

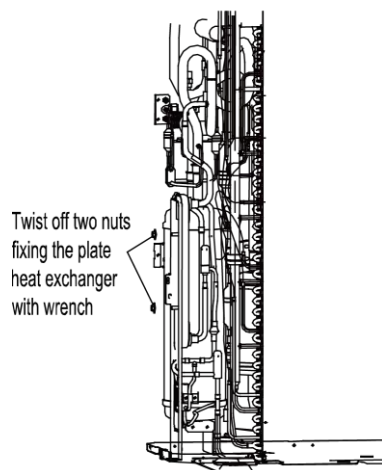
Removal operation for plate heat exchanger		
Remark: Before removing the plate heat exchanger, please make sure that there's no refrigerant inside the pipeline of system and disconnect the power		
Process	Photo	Operation Instruction
1) Twist off two nuts fixing the plate heat exchanger with wrench	 <p>Twist off two nuts fixing the plate heat exchanger with wrench</p>	<ul style="list-style-type: none"> • Twist off two nuts fixing the plate heat exchanger with wrench

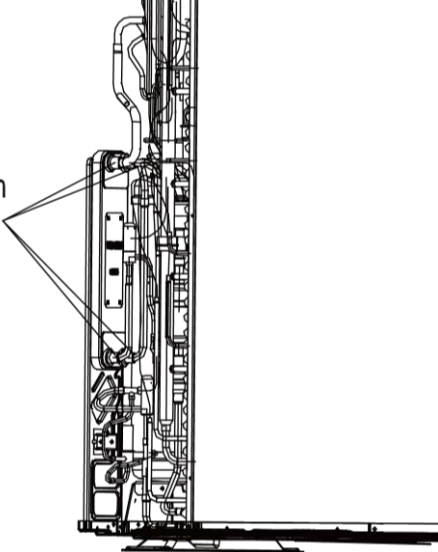
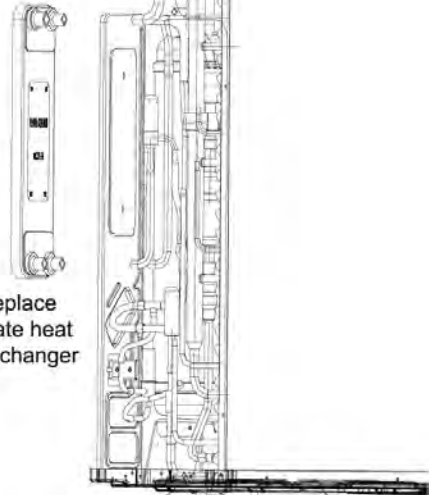
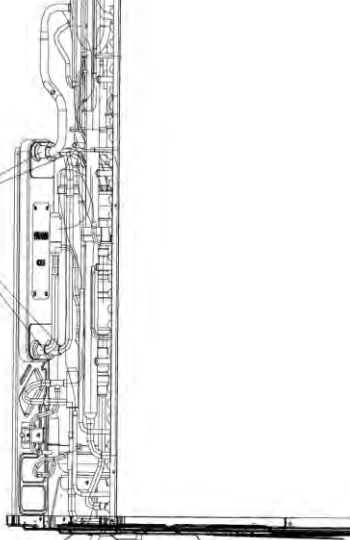
Removal operation for plate heat exchanger		
Remark: Before removing the plate heat exchanger, please make sure that there's no refrigerant inside the pipeline of system and disconnect the power		
Process	Photo	Operation Instruction
2) Disconnect inlet pipe and outlet pipe of plate heat exchanger	 <p>Weld those 4 connection spots on the plate heat exchanger</p>	<ul style="list-style-type: none"> Weld those 4 connection spots on the plate heat exchanger, and then pull out the connection pipe. <p>Note: During welding process, do not let flame burn out other parts</p>
3) Replace plate heat exchanger	 <p>Replace plate heat exchanger</p>	<ul style="list-style-type: none"> Replace plate heat exchanger
4) Replace gas liquid separator	 <p>Weld the pipe connected with plate heat exchanger</p>	<ul style="list-style-type: none"> Weld the pipe connected with plate heat exchanger <p>Note: During welding process, do not let flame burn out other parts</p>

5.2.2 GMV-80WL/A-T GMV-100WL/A-T GMV-121WL/A-T GMV-80WL/C-T GMV-100WL/C-T GMV-121WL/C-T series unit

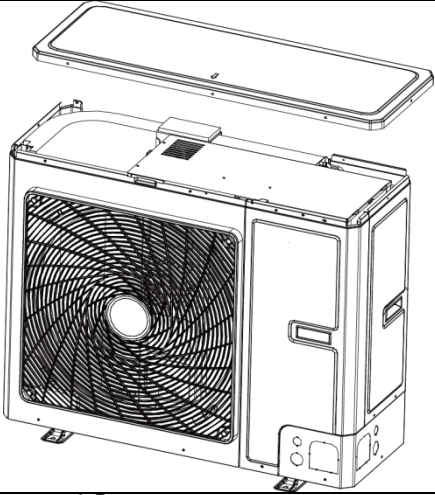
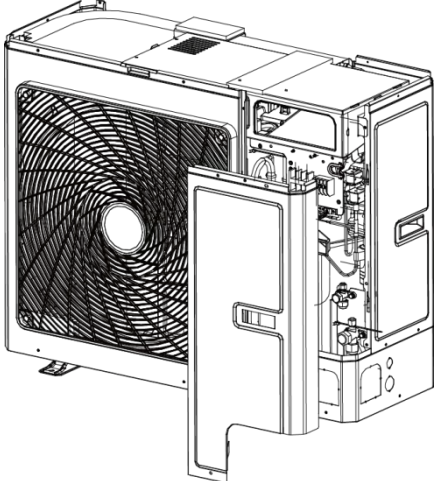
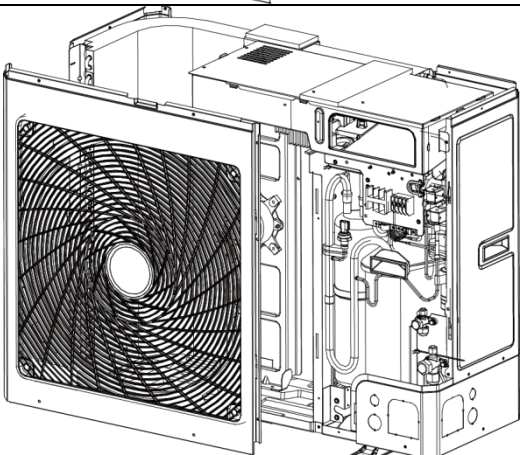
Removal operation for panel		
Remark: Before removing the panel, please make sure that the unit is disconnected with the power		
Process	Photo	Operation Instruction
1.Remove top cover		<ul style="list-style-type: none"> • Loose the screws fixing the top cover with screwdriver • Hold the top cover upwards and then put it on the floor flatly
2. Remove front side plate sub-assy		<ul style="list-style-type: none"> • Loose the screw fixing the front side plate with screwdriver • Hold the front side plate upwards and then put it on the floor flatly
3. Remove front panel and grille		<ul style="list-style-type: none"> • Loose the screws fixing the front panel and grille with screwdriver • Put the front panel and grille on the floor flatly

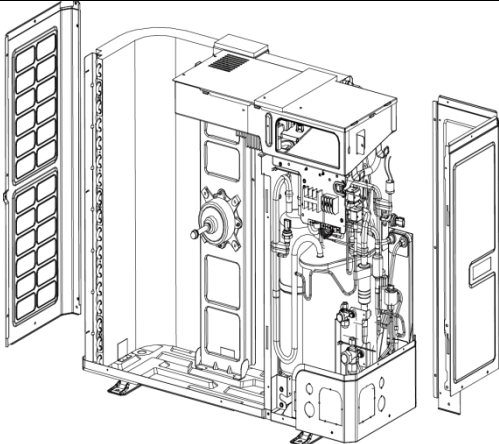
Removal operation for panel		
Remark: Before removing the panel, please make sure that the unit is disconnected with the power		
Process	Photo	Operation Instruction
4. Remove left side plate and rear side plate		<ul style="list-style-type: none"> • Loose screws fixing left side plate and rear side plate with screwdriver • remove the rear side plate

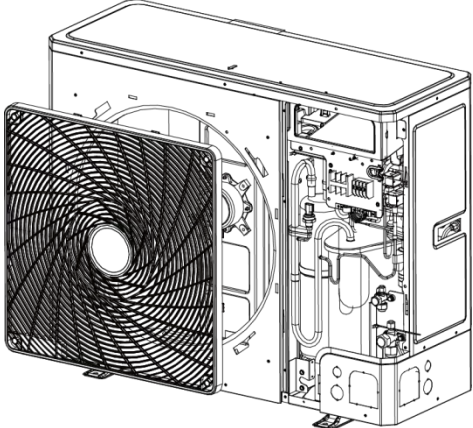
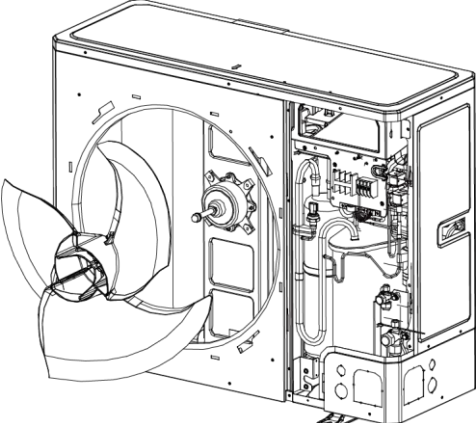
Removal operation for blade		
Remark: Before removing the motor, please make sure that the unit is disconnected with the power.		
Process	Photo	Operation Instruction
1. Remove grille		<ul style="list-style-type: none"> • Loose screws fixing the panel with screwdriver • Then remove the grille
2. Remove blade		<ul style="list-style-type: none"> • Loosen nuts fixing the blade with wrench • Then remove the blade and put it on the floor flatly

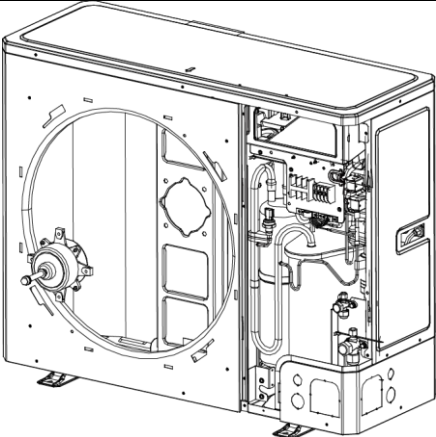
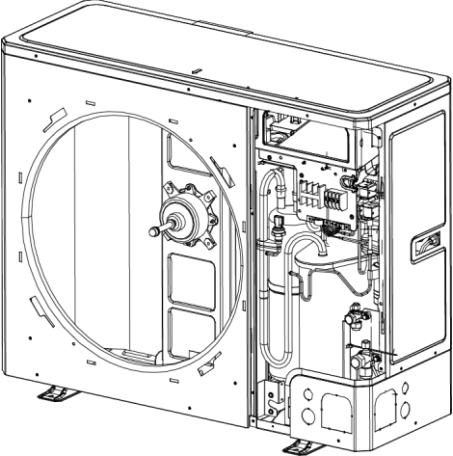
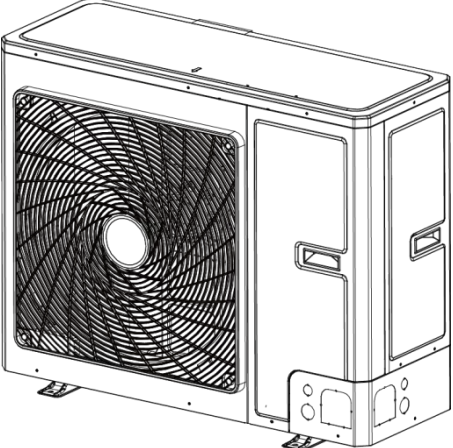
Removal operation for blade		
Remark: Before removing the motor, please make sure that the unit is disconnected with the power.		
Process	Photo	Operation Instruction
3. Remove motor		<ul style="list-style-type: none"> • Loose screws fixing the motor with screwdriver • then remove the power cord of motor • Take out the damaged motor
4. Install motor		<ul style="list-style-type: none"> • Replace the motor, tighten screws with screwdriver and then connect the power cord of motor
5. Assemble unit		<ul style="list-style-type: none"> • Assemble the unit in the the converse sequence

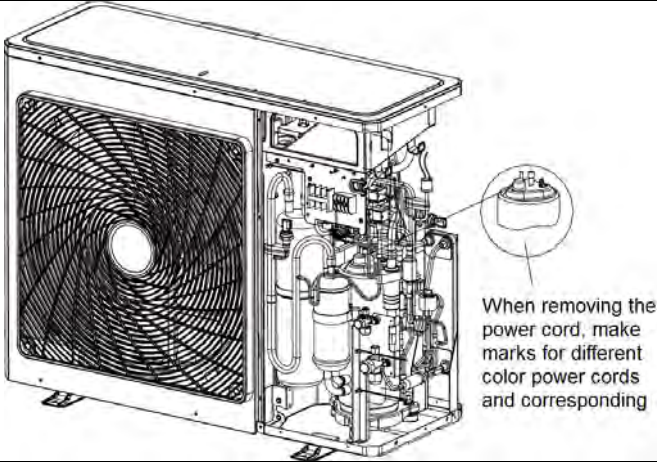
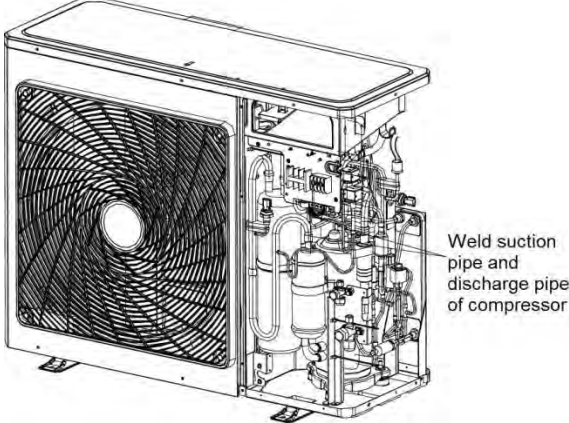
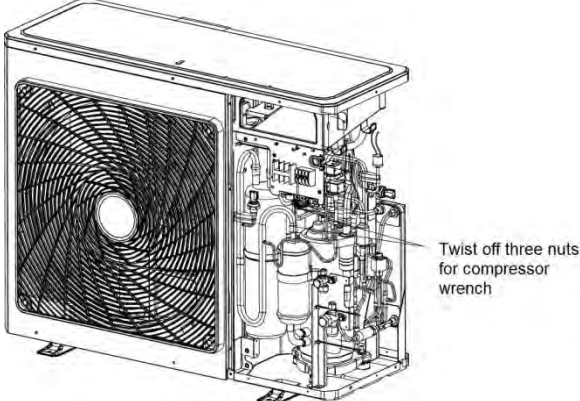
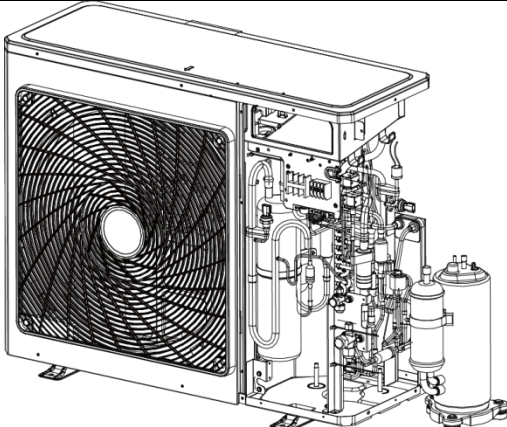
Removal operation of compressor		
Remark: Before removing the compressor, please make sure that there's no refrigerant inside the pipeline and the power is disconnected.		
Process	Photo	Operation Instruction
1. Remove wiring cover of compressor	 <p>When removing the power cord, make marks for different color power cords and corresponding</p>	<ul style="list-style-type: none"> Loose screws fixing the compressor with screwdriver Then pull out the power cord <p>Note: When removing the power cord, make marks for different color power cords and corresponding wiring terminals for wrong terminal.</p>
2. Disconnect compressor and connected pipeline	 <p>Weld suction pipe and discharge pipe of compressor</p>	<ul style="list-style-type: none"> Weld suction pipe and discharge pipe of compressor then pull out the connection pipe from the compressor <p>Note: During welding process, do not let the flame burn out other parts.</p>
3. Loose nuts fixing the foot of compressor	 <p>Twist off three nuts for compressor wrench</p>	<p>Twist off the nuts for compressor with wrench</p>
4. Remove the compressor from the chassis		<ul style="list-style-type: none"> Take out the compressor and replace it <p>Note: When replacing the compressor, do not damage nearby pipelines and other parts</p>

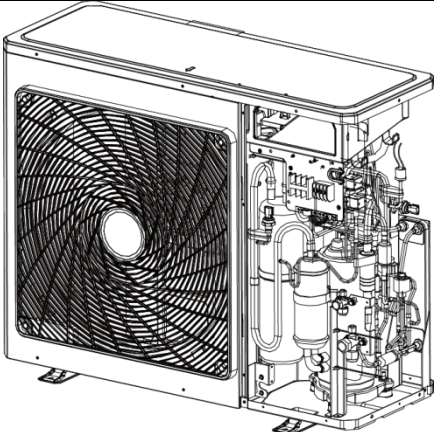
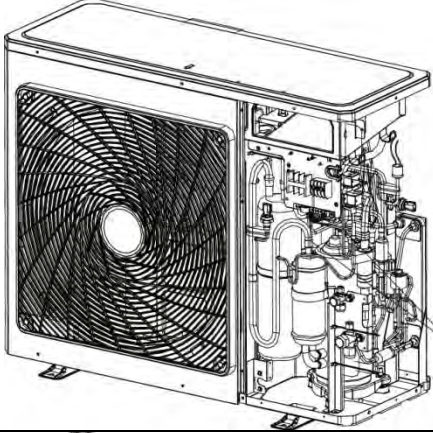
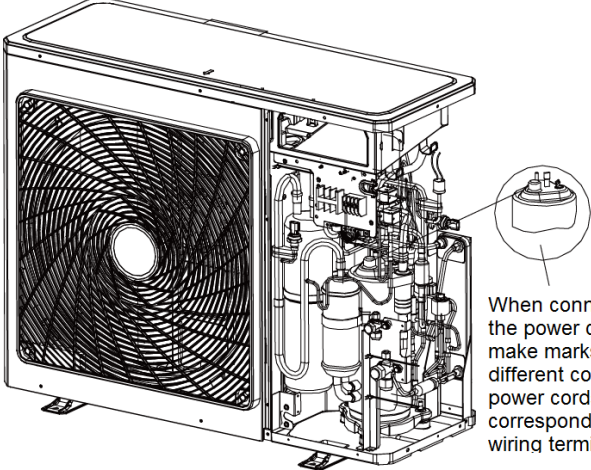
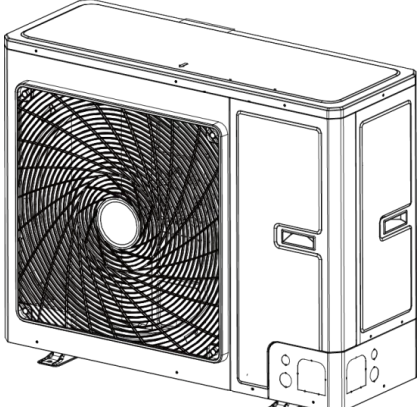
Removal operation of compressor		
Remark: Before removing the compressor, please make sure that there's no refrigerant inside the pipeline and the power is disconnected.		
Process	Photo	Operation Instruction
5. Fix the new compressor at the chassis		After replacing the compressor, fix the nuts at the bottom of compressor
6. Connect suction pipe and discharge pipe of compressor and pipeline of system again	 <p>Connect suction pipe and discharge pipe of compressor and pipeline of system again</p>	Weld the connection pipe of compressor, connect the pipeline and compressor Note: During welding process, do not let flame burn out other parts
7. Connect the power cord of compressor well	 <p>When connecting the power cord, make marks for different color power cords and corresponding wiring terminals</p>	<ul style="list-style-type: none"> ● Loose screws fixing the power cord with screwdriver ● connect the power cord well again Note: When connecting the power cord, make marks for different color power cords and corresponding wiring terminals.
8. Check and open the upper cover plate		<ul style="list-style-type: none"> ● Check whether the pipeline is connected well ● Check whether all parts and connection wires are connected well ● If there's no problem after checking, install front and rear cover plates.

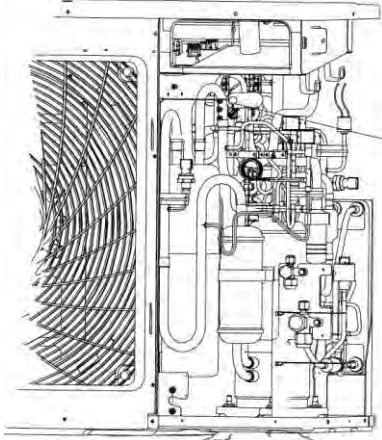
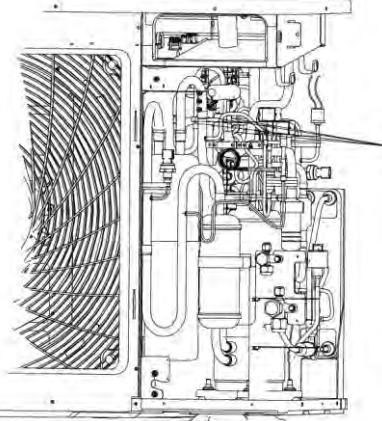
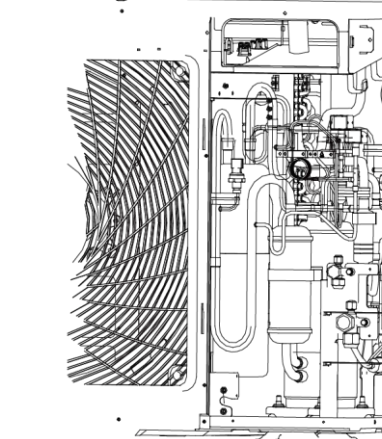
Removal operation for 4-way valve		
Remark: Before removing the 4-way valve, please make sure that there's no refrigerant inside the pipeline of system and then power is disconnected.		
Process	Photo	Operation Instruction
1. Disconnect the coil of 4-way valve from the 4-way valve	 <p>Remove the coil of 4-way valve at first</p>	<ul style="list-style-type: none"> ● Remove the coil of 4-way valve at first
2. Disconnect the 4-way valve and connection pipeline	 <p>Weld those 4 connection spots on 4-way valve</p>	<ul style="list-style-type: none"> ● Weld those 4 connection spots on 4-way valve, and then pull out the connection pipe <p>Note: During welding process, do not let the flae burn out other parts</p>
3. Replace 4-way valve		<ul style="list-style-type: none"> ● Replace 4-way valve <p>Note: During welding process, do not let the flame burn out other parts</p>

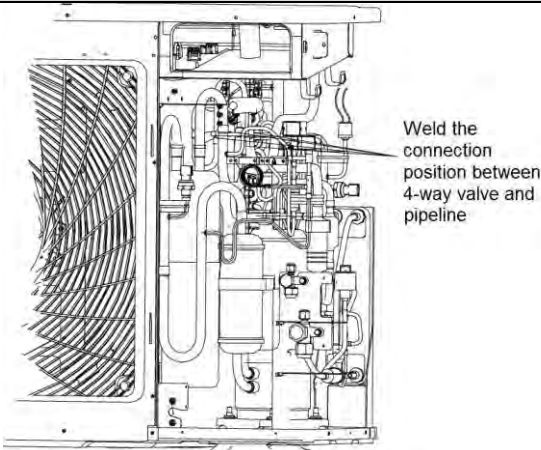
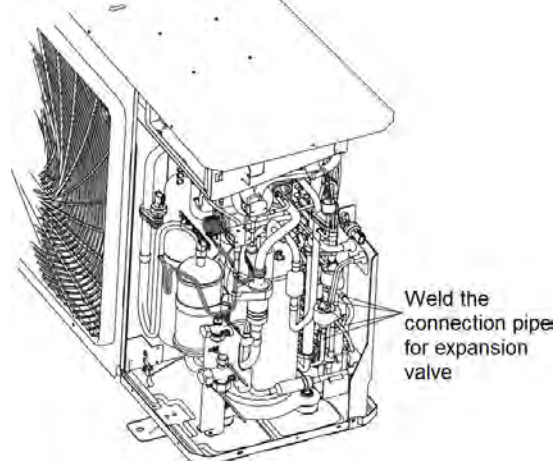
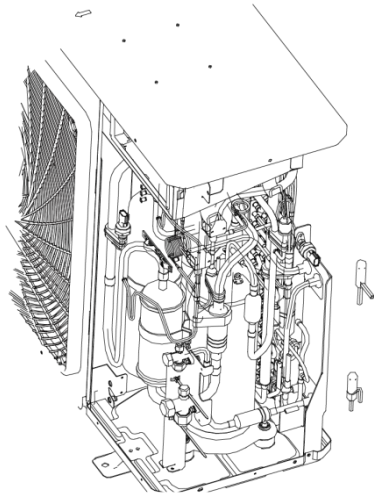
Removal operation for 4-way valve		
Remark: Before removing the 4-way valve, please make sure that there's no refrigerant inside the pipeline of system and then power is disconnected.		
Process	Photo	Operation Instruction
4. Replace 4-way valve		<ul style="list-style-type: none"> Weld the connection position between 4-way valve and pipeline <p>Note: During welding process, do not let flame burn out other parts</p>
Removal operation for electronic expansion valve		
Remark: Before removing the electronic expansion valve, please make sure that there's no refrigerant in the pipeline of system and the power is disconnected		
Process	Photo	Operation Instruction
1. Disconnect the electronic expansion valve from the pipeline		<ul style="list-style-type: none"> Remove the coil of electronic expansion valve at first Weld the connection pipe for expansion valve, and then pull out the connection pipe <p>Note: During welding process, do not let flame burn out other parts</p>
2. Take out the electronic expansion valve and replace it		<ul style="list-style-type: none"> Take out the electronic expansion valve and replace it

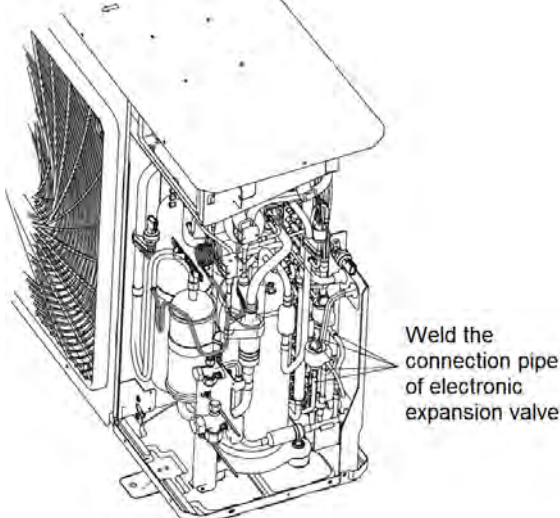
Removal operation for 4-way valve		
Remark: Before removing the 4-way valve, please make sure that there's no refrigerant inside the pipeline of system and then power is disconnected.		
Process	Photo	Operation Instruction
3. Replace electronic expansion valve	 <p>Weld the connection pipe of electronic expansion valve</p>	<ul style="list-style-type: none"> • Weld the connection pipe of electronic expansion valve • Install the coil of electronic expansion valve <p>Note: During welding process, do not let the flame burn out other parts</p>

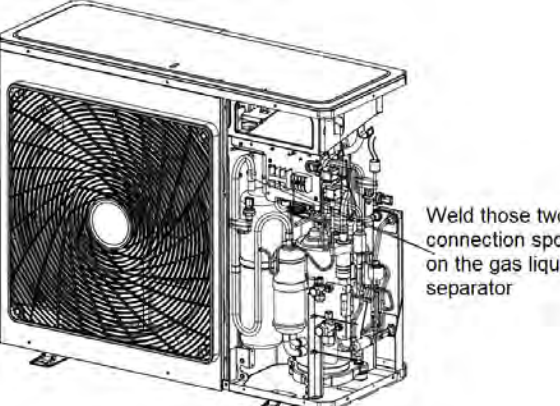
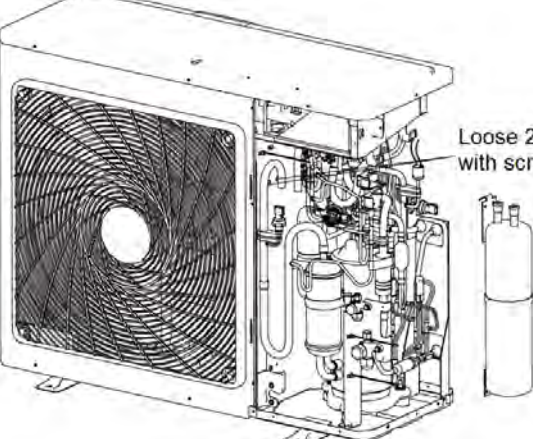
Removal operation of gas liquid separator		
Remark: Before removing the gas liquid separator, please make sure that there's no refrigerant inside the pipeline of system and disconnect the power		
Process	Photo	Operation Instruction
1. Disconnect inlet pipe and exit pipe of gas liquid separator	 <p>Weld those two connection spots on the gas liquid separator</p>	<ul style="list-style-type: none"> • Weld those two connection spots on the gas liquid separator and then pull out the connection pipe <p>Note: During welding process, do not let flame burn out other parts</p>
2. Replace gas liquid separator	 <p>Loose 2 screws with screwdriver</p>	<ul style="list-style-type: none"> • Loose 4 screws with screwdriver • Replace gas liquid separator

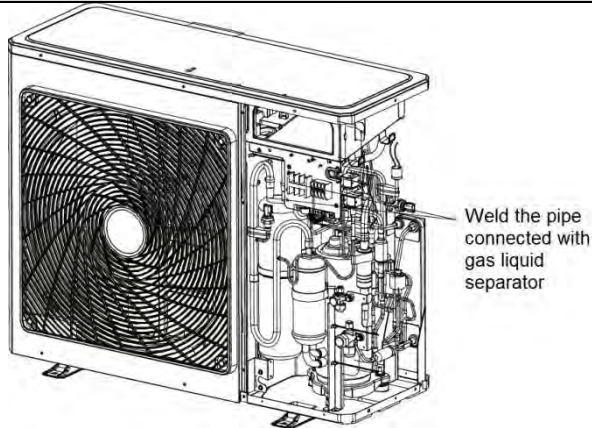
Removal operation of gas liquid separator		
Remark: Before removing the gas liquid separator, please make sure that there's no refrigerant inside the pipeline of system and disconnect the power		
Process	Photo	Operation Instruction
3. Replace gas liquid separator		<ul style="list-style-type: none"> • Weld the pipe connected with gas liquid separator • Fix the screws at the base of gas liquid separator well again <p>Note: During welding process, do not let flame burn out other parts</p>

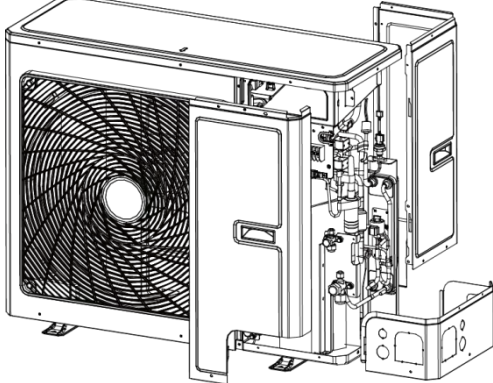
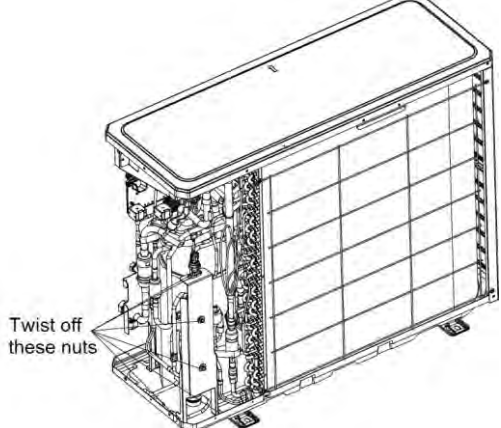
Removal operation for plate heat exchanger		
Remark: Before removing the plate heat exchanger, please make sure that there's no refrigerant inside the pipeline of system and disconnect the power		
Process	Photo	Operation Instruction
1. Remove top cover, back plate and right plate		<ul style="list-style-type: none"> • Twist off the nuts fixing the plate, remove front plate firstly, then remove right plate, and remove back plate finally
2. Remove the bracket of plate heat exchanger		<ul style="list-style-type: none"> • Twist off the nuts fixing the bracket of plate heat exchanger

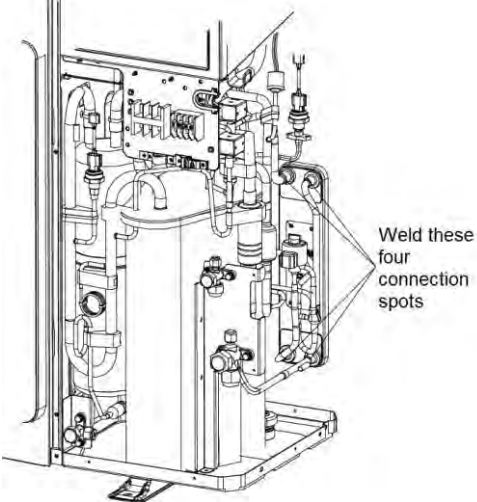
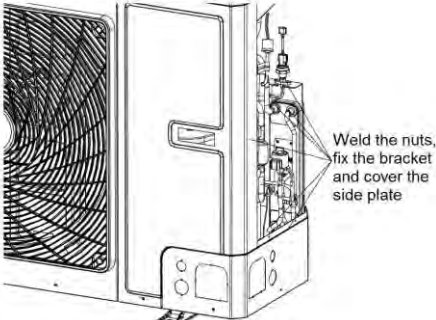
Removal operation for plate heat exchanger		
Remark: Before removing the plate heat exchanger, please make sure that there's no refrigerant inside the pipeline of system and disconnect the power		
Process	Photo	Operation Instruction
<p>3. Weld those 4 connection spots on the plate heat exchanger, and then pull out plate heat exchanger</p>		<ul style="list-style-type: none"> ●Weld those 4 connection spots on the plate heat exchanger, and then pull out the connection pipe. <p>Note: During welding process, do not let flame burn out other parts</p>
<p>4. Replace new plate heat exchanger</p>		<ul style="list-style-type: none"> ● Weld the pipe connected with plate heat exchanger <p>Note: During welding process, do not let flame burn out other parts</p>

6 Common Maintenance

6.1 Vacuum drying for the system

6.1.1 Selection requirement for the vacuum pump

Do not use different vacuum pump for vacuum-pumping for different refrigerant system;

The final vacuum for the vacuum pump should reach -0.1MPa ;

The air discharge volume for the vacuum pump should reach 4L/S above;

The precision of vacuum pump should reach 0.02mmHg above;

The system vacuum pump for R410A must be with check valve.

6.1.2 Operation procedure and notices for Vacuum drying

1) Operation procedure

- a. Before vacuum-pumping, please confirm that the cut-off valve for gas pipe and liquid pipe is at off status;
 - b. Use charging conduct pipe to connect the governing valve and vacuum heat pump to the detection joint of gas valve and liquid valve;
 - c. After vacuum-pumping for 4h, check whether the vacuum degree is reached to -0.1MPa or above; If not, there may be gas leakage. Please perform the leakage inspection again. If there's no gas leakage, please vacuum pump for another 2h.
 - d. If the required vacuum degree can't be satisfied after vacuum-pumping for two times, there are water inside the pipeline. Please drain out the water by the method of vacuum damage. The detailed method: charge 0.05MPa nitrogen into the pipeline, vacuum pump for 2h and then keep the vacuum for 1h. If -0.1MPa vacuum degree still can't be reached, repeat this operation until the water is drained out completely.
- 2) After the vacuum pump is finished, turn off the valve of governing valve and stop vacuum pump and keep it for 1h. Please confirm that the pressure of governing valve hasn't been increased.
- a. Vacuum pump for the gas pipe and liquid valve at the same time;

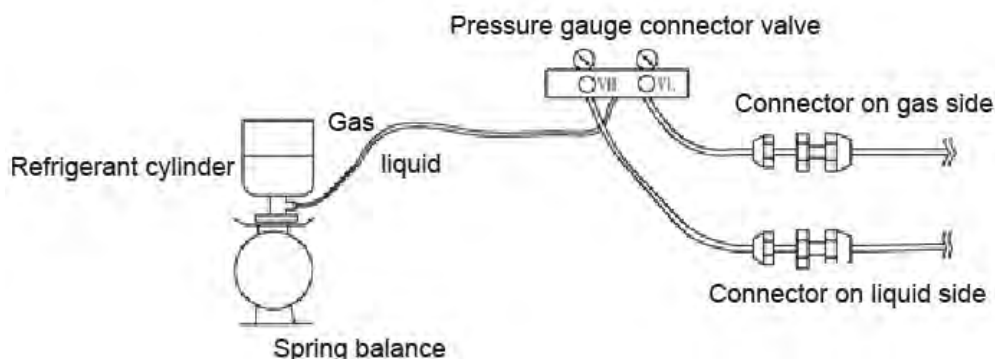

- b. When turn off the vacuum pump to stop vacuum-pumping, please turn off the valve at first and then de-energize the vacuum pump;
- c. Keep the vacuum pump for 2h and confirm that the pressure of vacuum meter hasn't been increased.

6.2 Fill and charge refrigerant

6.2.1 Filling procedure of refrigerant

a. Calculate the additional volume of refrigerant (GMV-120WL/A-T、GMV-140WL/A-T、GMV-160WL/A-T、GMV-120WL/A-X、GMV-140WL/A-X、GMV-160WL/A-X)

(1) Refrigerant quantity of outdoor unit before delivery:

Model	GMV-120WL/A-T	GMV-140WL/A-T	GMV-160WL/A-T	GMV-120WL/A-X	GMV-140WL/A-X	GMV-160WL/A-X
Refrigerant Qty (kg)	5.0	5.0	5.0	5.0	5.0	5.0



Note:

- ① The refrigerant amount charged before delivery doesn't include the amount that needs to be added to indoor units and the connection pipeline.
- ② Length of connection pipe is decided on site. Therefore the amount of additional refrigerant shall be decided on site according to the dimension and length of field-installed liquid pipe.
- ③ Record the amount of additional refrigerant for convenience of after-sales service.

(2) Calculation of the amount of additional refrigerant

Calculation method of the quantity of additional refrigerant (based on liquid pipe)

Quantity of additional refrigerant = \sum length of liquid pipe X quantity of additional refrigerant per meter

Quantity of additional refrigerant per meter for liquid pipe (kg/m)					
Φ22.2	Φ19.05	Φ15.9	Φ12.7	Φ9.52	Φ6.35
0.35	0.25	0.17	0.11	0.054	0.022

Note: Liquid pipe that is within 20m doesn't need to be added with refrigerant.

First confirm that there is no leakage from the system. When compressor is not working, charge additional R410a with specific amount to the unit through the filling opening of the liquid pipe valve of the outdoor unit. If required amount cannot be quickly filled due to pressure increase of the pipe, then set the unit in cooling startup and fill refrigerant from the low pressure check valve of the outdoor unit.

(3) Calculation example

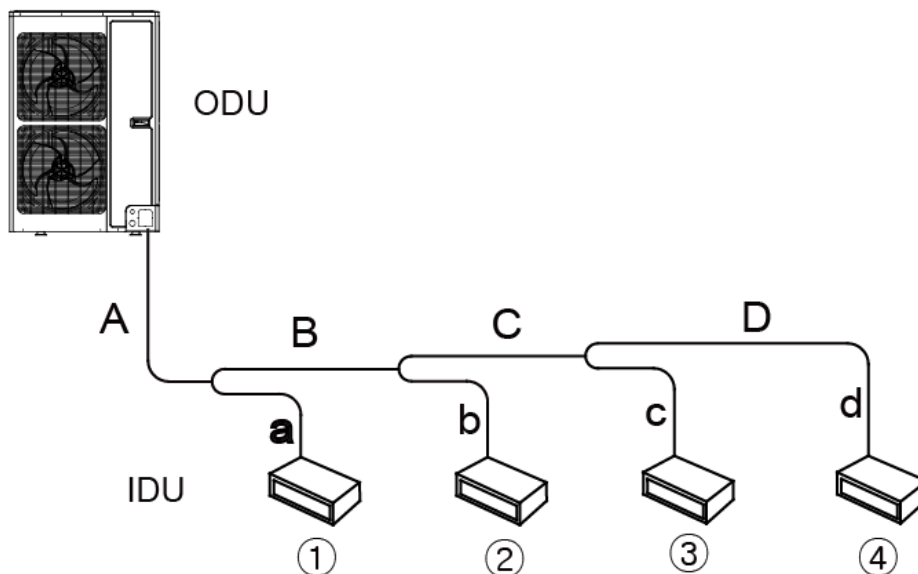

IDU

No.	IDU ①	IDU ②	IDU ③	IDU ④
Model	Duct type GMV-ND72PL/B-T	Duct type GMV-ND50PL/B-T	Duct type GMV-ND36PL/B-T	Duct type GMV-ND25PL/B-T

Liquid pipe:

No.	A	B	C	D
Pipe size	Φ9.52	Φ9.52	Φ9.52	Φ6.35
Length	10m	5m	5m	5m
No.	a	b	c	d
Pipe size	Φ9.52	Φ6.35	Φ6.35	Φ6.35
Length	3m	3m	2m	1m

Total length of each liquid pipe

Φ9.52: $A+B+C+a=10+10+5+3=23m$

Φ6.35: $D+b+c+d=5+3+2+1=11m$

Note: Liquid pipe that is within 20m doesn't need to be added with refrigerant.

Therefore, the minimum quantity of additional refrigerant = $(23-20) \times 0.054 + 11 \times 0.022 = 0.404kg$

b. Calculate the additional volume of refrigerant (GMV-80WL/C-T, GMV-100WL/C-T, GMV-121WL/C-T, GMV-80WL/A-T, GMV-100WL/A-T, GMV-121WL/A-T, GMV-120WL/C-T, GMV-140WL/C-T, GMV-160WL/C-T, GMV-120WL/C-X, GMV-140WL/C-X, GMV-160WL/C-X)

(1) Refrigerant quantity of outdoor unit before delivery:

Model	GMV-80WL/A-T	GMV-100WL/A-T	GMV-121WL/A-T	GMV-80WL/C-T	GMV-100WL/C-T	GMV-121WL/C-T	GMV-120WL/C-T	GMV-140WL/C-T	GMV-160WL/C-T	GMV-120WL/C-X	GMV-140WL/C-X	GMV-160WL/C-X
Refrigerant Qty (kg)	1.8	1.8	2.0	1.8	1.8	2.0	3.3	3.3	3.3	3.3	3.3	3.3



Note:

- ① The refrigerant amount charged before delivery doesn't include the amount that needs to be added to indoor units and the connection pipeline.
- ② Length of connection pipe is decided on site. Therefore the amount of additional refrigerant shall be decided on site according to the dimension and length of field-installed liquid pipe.
- ③ Record the amount of additional refrigerant for convenience of after-sales service.

(2) Calculation of the amount of additional refrigerant

Calculation method of the quantity of additional refrigerant (based on liquid pipe)

Quantity of additional refrigerant = $\sum \text{length of liquid pipe} \times \text{quantity of additional refrigerant per meter} + (\text{quantity of indoor unit} - 2) \times 0.3$

Quantity of additional refrigerant per meter for liquid pipe (kg/m)					
Φ22.2	Φ19.05	Φ15.9	Φ12.7	Φ9.52	Φ6.35
0.35	0.25	0.17	0.11	0.054	0.022

First confirm that there is no leakage from the system. When compressor is not working, charge additional R410a with specific amount to the unit through the filling opening of the liquid pipe valve of the outdoor unit. If required amount cannot be quickly filled due to pressure increase of the pipe, then set the unit in cooling startup and fill refrigerant from the low pressure check valve of the outdoor unit.

(3) Calculation example

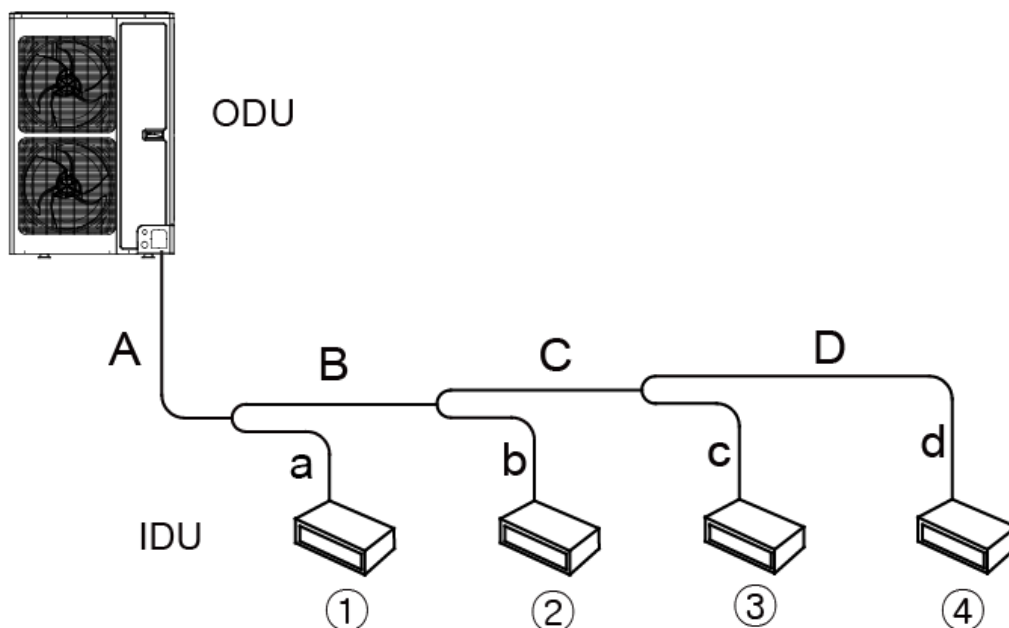

IDU				
No.	IDU ①	IDU ②	IDU ③	IDU ④
Model	Duct type GMV-ND72PL/B-T	Duct type GMV-ND50PL/B-T	Duct type GMV-ND36PL/B-T	Duct type GMV-ND25PL/B-T

Liquid pipe:				
No.	A	B	C	D
Pipe size	Φ9.52	Φ9.52	Φ9.52	Φ6.35
Length	10m	5m	5m	5m
No.	a	b	c	d
Pipe size	Φ9.52	Φ6.35	Φ6.35	Φ6.35
Length	3m	3m	2m	1m

Total length of each liquid pipe

Φ9.52: $A+B+C+a=10+105+5+3=23\text{m}$

Φ6.35: $D+b+c+d=5+3+2+1=11\text{m}$

Quantity of indoor unit: 4 sets

Therefore, the minimum quantity of additional refrigerant = $(23 \times 0.054 + 11 \times 0.022) + (4 - 2) \times 0.3 = 2.084\text{kg}$

c. Calculate the additional volume of refrigerant (GMV-H224WL/A-X、GMV-H280WL/A-X、GMV-H335WL/A-X、GMV-224WL/C-X、GMV-280WL/C-X、GMV-335WL/C-X)

(1) Refrigerant quantity of outdoor unit before delivery:

Model	GMV-H224WL/A-X GMV-224WL/C-X	GMV-H280WL/A-X GMV-280WL/C-X	GMV-H335WL/A-X GMV-335WL/C-X
Refrigerant Qty (kg)	5.5	7.1	8.0



Note:

- ① The refrigerant amount charged before delivery doesn't include the amount that needs to be added to indoor units and the connection pipeline.
- ② Length of connection pipe is decided on site. Therefore the amount of additional refrigerant shall be decided on site according to the dimension and length of field-installed liquid pipe.
- ③ Record the amount of additional refrigerant for convenience of after-sales service.

(2) Calculation of the amount of additional refrigerant

Calculation method of the quantity of additional refrigerant (based on liquid pipe)

Quantity of additional refrigerant = \sum length of liquid pipe X quantity of additional refrigerant per meter

Quantity of additional refrigerant per meter for liquid pipe (kg/m)					
Φ22.2	Φ19.05	Φ15.9	Φ12.7	Φ9.52	Φ6.35
0.35	0.25	0.17	0.11	0.054	0.022

Note: First confirm that there is no leakage from the system. When compressor is not working, charge additional R410a with specific amount to the unit through the filling opening of the liquid pipe valve of the outdoor unit. If required amount cannot be quickly filled due to pressure increase of the pipe, then set the unit in cooling startup and fill refrigerant from the low pressure check valve of the outdoor unit.

(3) Calculation example

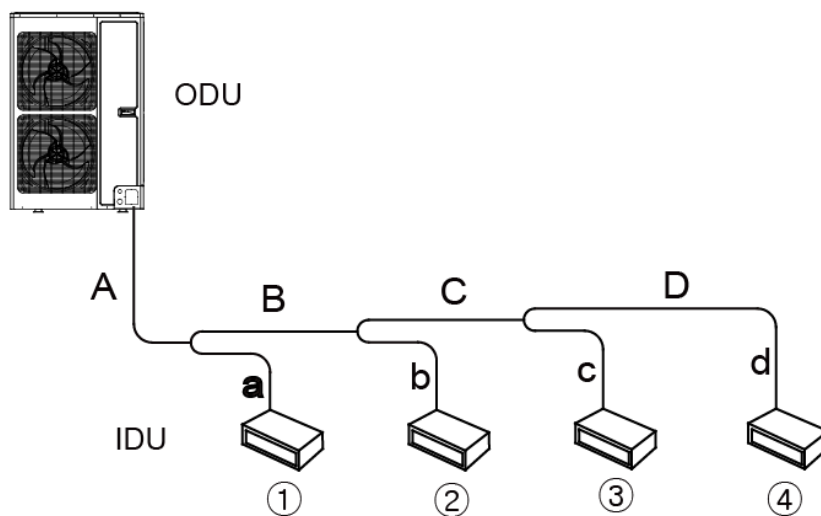

IDU	IDU ①	IDU ②	IDU ③	IDU ④
No.				
Model	Duct type GMV-ND72PL/B-T	Duct type GMV-ND50PL/B-T	Duct type GMV-ND36PL/B-T	Duct type GMV-ND25PL/B-T

Liquid pipe:

No.	A	B	C	D
Pipe size	Φ9.52	Φ9.52	Φ9.52	Φ6.35
Length	10m	5m	5m	5m
No.	a	b	c	d
Pipe size	Φ9.52	Φ6.35	Φ6.35	Φ6.35
Length	3m	3m	2m	1m

Total length of each liquid pipe

Φ9.52: $A+B+C+a=10+10+5+3=23m$

Φ6.35: $D+b+c+d=5+3+2+1=11m$

The minimum quantity of additional refrigerant = $23 \times 0.054 + 11 \times 0.022 = 1.484kg$

6.3 Airtightness test

6.3.1 Importance of airtightness test

The airtightness of VRF system is the leak tightness of the pipeline for refrigerant, which the guarantee for safe and reliable operation. The leakage of refrigerant may affect the operation of air conditioner seriously, or even damage compressor and then lead to breakdown of system. Therefore, it needs to perform the airtightness test. If there's gas leakage after the system is installed completely, because the indoor ceiling decoration are all finished, it's will be very difficult to find out the leakage point. Thus, the airtightness test of the system must be finished before finishing indoor decoration.

6.3.2 Operation procedure for the airtightness test

Before ex-factory, cut-off valve for gas pipe and liquid pipe of outdoor unit is turned off. Please confirm that before operation.

Before testm please smear a little corresponding lubricant oil at and pipe terminal, and use two wrenches for fixing

Do not allow to connect the pipeline of outdoor unit for test during airtightness test.

The system test pressure for R410A is 4.15MPa (3.0MPa for R22 refrigerant system). Nitrogen must be used as the medium for the airtightness test and the nitrogen should be dry. Increase pressure slowly for three steps:

Step 1: Increase pressure slowly to 0.5MPa, stop for 5min and then check the gas leakage. Big leakage may be found out;

Step 2: Increase pressure slowly to 1.5MPa, stop for 5min to check the airtightness. Small leakage may be found out;

Step 3: Increase pressure slowly to 4.15MPa for R410A slowly (3.0MPa for R22 refrigerant system), stop for 5min and perform the strength test. Minor leakage or sand hole may be found. Increase pressure to test pressure, keep it for 24h and observe whether the pressure is decreasing. If not, the pressure is qualified.

6.3.3 Cautions

- a. The test manometer range for R410A should be 4.5MPa above (3.5MPa above for R22 refrigerant system);
- b. Record the data on manometerk, ambient temperature and test time at the same time;
- c. Pressure modification: when temperature changes 1°C , the temperature will change 0.01MPa correspondingly.
- d. Pressure should be kept the same.
- e. If it needs to keep pressure for a long time, decrease the pressire lower than 0.55MPa pr below. Long-time high pressure can lead to leakage at the welding position, which may cause riskl.
- f. Before the airtightness for the pipeline of refrigerant is finished, do not allow to insulate and bundle the welding positions and connection position of bellmouth of indoor unit.

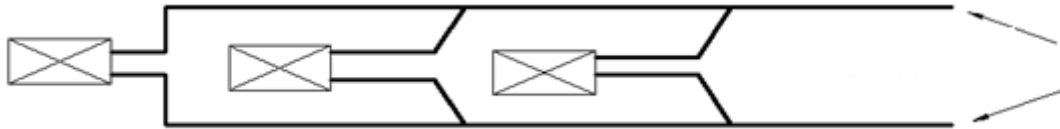

Add pressure from gas pipe and liquid pipe at the same time

Note: Before airtightness test, all welding lines can't be insulated and bundled.

7 Exploded View of Unit and Parts' List

7.1 Exploded view for outdoor unit and parts' list

1) Model: GMV-80WL/A-T、GMV-100WL/A-T、GMV-80WL/C-T、GMV-100WL/C-T

、 Exploded view

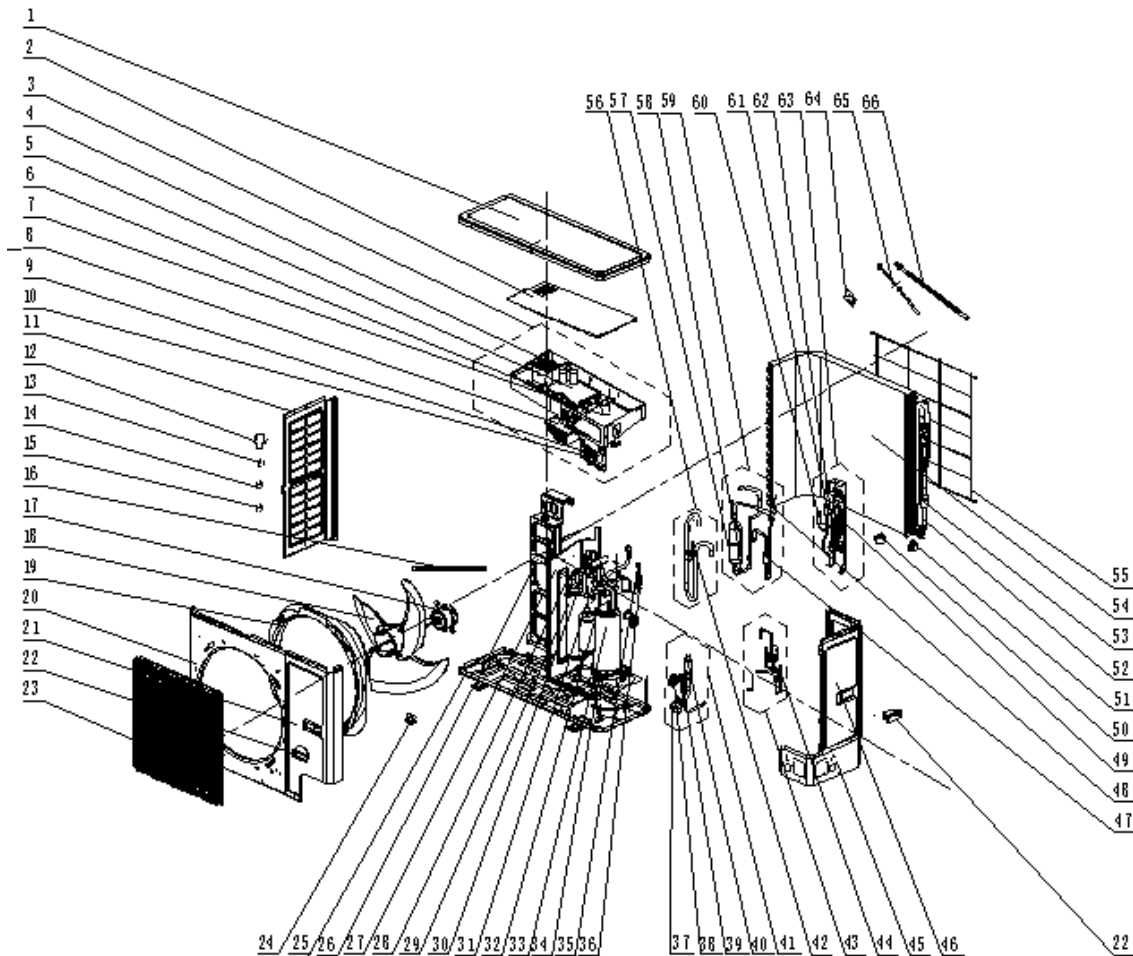

NO.	Name of Part	GMV-80WL/A-T、GMV-100WL/A-T、 GMV-80WL/C-T、GMV-100WL/C-T	
		Product Code	CN850W0530 CN850W0430 CN850W0600 CN850W0590
		Part Code	Quantity
1	Coping	'01264100027P	1
2	Electric Box Cover	'01424100064	1
3	Electric Box Assy	'100002000960	1

NO.	Name of Part	GMV-80WL/A-T、GMV-100WL/A-T、 GMV-80WL/C-T、GMV-100WL/C-T	
		Product Code	CN850W0530 CN850W0430 CN850W0600 CN850W0590
		Part Code	Quantity
4	PFC Inductance	'43120011	1
5	Main Board	'30221000024	1
6	Filter Board	'300020000004	1
7	Main Board	'30226000045	1
8	Radiator	'4901800007501	1
9	Terminal Board	'42011242	1
10	Terminal Board	'42018000026	1
11	Left Side Plate	'01314100043P	1
12	Drainage Connector	'06123401	1
13	Compressor Overload Protector(External)	'00180030	1
14	Compressor Overload Protector(External)	'00183032	1
15	Compressor Overload Protector(External)	'00183051	1
16	Electric Heater(Compressor)	'7651873215	1
17	Brushless DC Motor	'1570280000401	1
18	Axial Flow Fan	'10434100005	1
19	Diversion Circle	'10474100003	1
20	Cabinet	'01514100007P	1
21	Front Side Plate	'01314100044P	1
22	Handle	'26235253	1
23	Front Grill	'01572800003	1
24	Drainage hole Cap	'06813401	1
25	Chassis Sub-Assy	'017000000148P	1
26	Motor Support Sub-Assy	'01804100309	1
27	Clapboard Sub-Assy	'01244100020	1
28	Sensing Device	'322101002	1
29	Gas-liquid Separator	'07422809	1
30	Magnet Coil (electromagnetic valve)	'4304410018903	1
31	4-way Valve	'4300008201	1
32	Magnet Coil	'4304410018902	1
33	Compressor	'00205200003	1
34	Compressor Gasket	'76713066	1
35	Sensing Device	'322101032	1
36	Nozzle for Adding Freon	'06120014	1
37	Cut off Valve	'07334100016	1
38	Cut off Valve	'07130209	1
39	Strainer	'07212001	1
40	Bidirection Strainer	'07210044	1
41	Valve Support Assy	'01804100306	1
42	Nozzle for Adding Freon	6120012	1
43	Capillary Sub-Assy	'030006000255	1

NO.	Name of Part	GMV-80WL/A-T、GMV-100WL/A-T、 GMV-80WL/C-T、GMV-100WL/C-T	
		Product Code	CN850W0530 CN850W0430 CN850W0600 CN850W0590
		Part Code	Quantity
44	Electromagnetic Valve	'43000054	1
45	Right Side Plate	'01314100046P	1
46	Rear Side Plate	'01314100045P	1
47	Silencer	'07444105	1
48	Pressure Protect Switch	'4602000913	1
49	Plate-type Heat Exchanger	'00904100003	1
50	Electric Expand Valve Fitting	'4304413205	1
51	Electric Expand Valve Fitting	'4304413220	1
52	Strainer	'07212121	1
53	Silencer	'07245012	1
54	Condenser Sub-Assy	'01000200003302	1
55	Rear Grill	'01574100010	1
56	Inhalation Tube Sub-Assy	'04574100067	1
57	Oil Separator	'07228302	1
58	Strainer	'07415200002	1
59	Discharge Tube Sub-Assy	'030013000499	1
60	Discharge Charge Valve	'07133771	1
61	Electronic Expansion Valve	'07334390	1
62	Electronic Expansion Valve	'07334447	1
63	Plate-type Heat Exchanger Assy	'00904100035	1
64	Sensor Sub-assy	'39008000060G	1
65	Electrical Heater	'765100047	1
66	Corrugated Pipe	'05015408	1

1) Model: GMV-121WL/A-T、GMV-121WL/C-T Exploded view

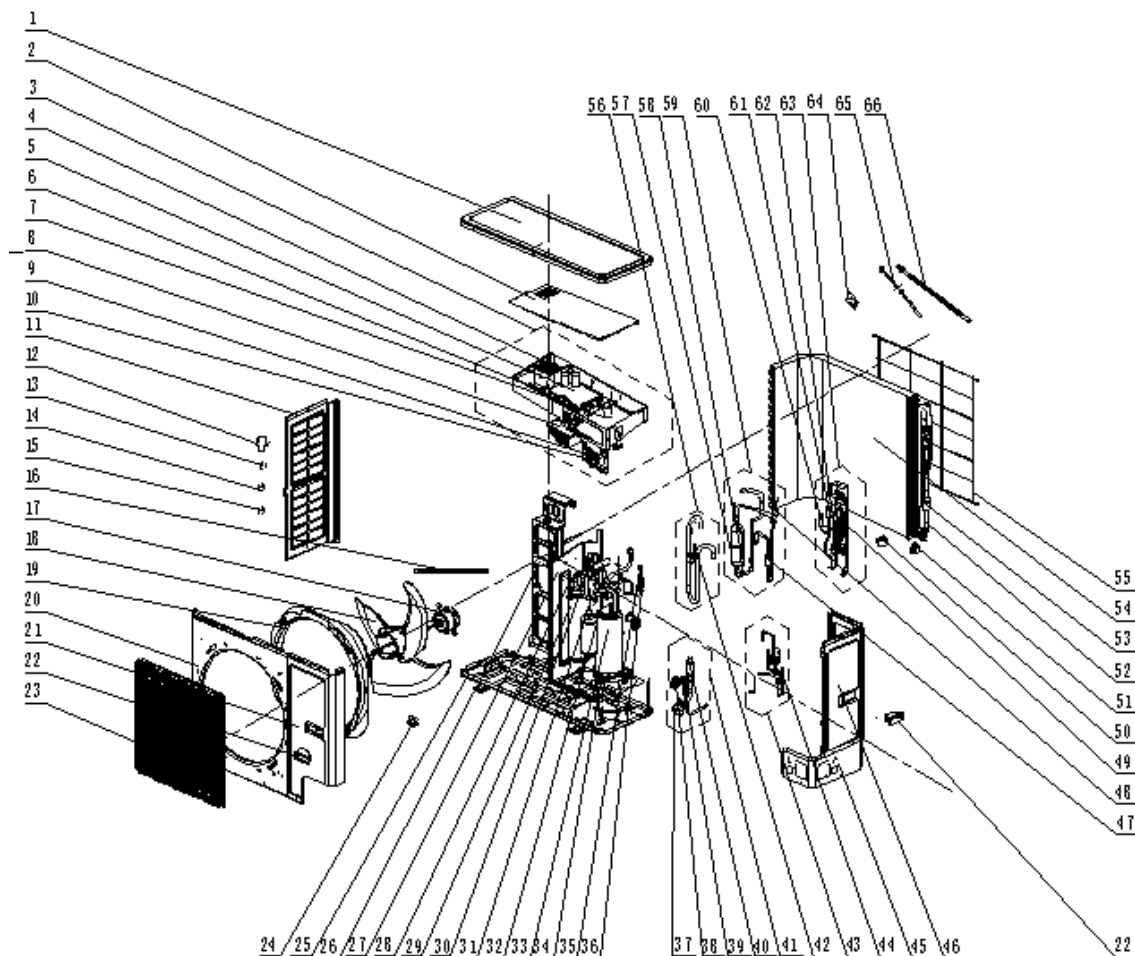

NO.	Name of Part	GMV-121WL/A-T GMV-121WL/C-T	
		Product Code	CN850W0420 CN850W0640
		Part Code	Quantity
1	Coping	'01264100027P	1
2	Electric Box Cover	'01424100064	1
3	Electric Box Assy	'100002000960	1
4	PFC Inductance	'43120011	1
5	Main Board	'30221000024	1
6	Filter Board	'300020000004	1
7	Main Board	'30226000045	1
8	Radiator	'4901800007501	1
9	Terminal Board	'42011242	1
10	Terminal Board	'42018000026	1
11	Left Side Plate	'01314100043P	1
12	Drainage Connector	'06123401	1
13	Compressor Overload Protector(External)	'00180030	1
14	Compressor Overload Protector(External)	'00183032	1

NO.	Name of Part	GMV-121WL/A-T GMV-121WL/C-T	
		Product Code	CN850W0420 CN850W0640
		Part Code	Quantity
15	Compressor Overload Protector(External)	'00183051	1
16	Electric Heater(Compressor)	'7651873215	1
17	Brushless DC Motor	'1570280000401	1
18	Axial Flow Fan	'10434100005	1
19	Diversion Circle	'10474100003	1
20	Cabinet	'01514100007P	1
21	Front Side Plate	'01314100044P	1
22	Handle	'26235253	1
23	Front Grill	'01572800003	1
24	Drainage hole Cap	'06813401	1
25	Chassis Sub-Assy	'017000000148P	1
26	Motor Support Sub-Assy	'01804100309	1
27	Clapboard Sub-Assy	'01244100020	1
28	Sensing Device	'322101002	1
29	Gas-liquid Separator	'07422809	1
30	Magnet Coil (electromagnetic valve)	'4304410018903	1
31	4-way Valve	'4300008201	1
32	Magnet Coil	'4304410018902	1
33	Compressor	'00205200003	1
34	Compressor Gasket	'76713066	1
35	Sensing Device	'322101032	1
36	Nozzle for Adding Freon	'06120014	1
37	Cut off Valve	'07334100016	1
38	Cut off Valve	'07130209	1
39	Strainer	'07212001	1
40	Bidirection Strainer	'07210044	1
41	Valve Support Assy	'01804100306	1
42	Nozzle for Adding Freon	6120012	1
43	Capillary Sub-Assy	'030006000255	1
44	Electromagnetic Valve	'43000054	1
45	Right Side Plate	'01314100046P	1
46	Rear Side Plate	'01314100045P	1
47	Silencer	'07444105	1
48	Pressure Protect Switch	'4602000913	1
49	Plate-type Heat Exchanger	'00904100003	1
50	Electric Expand Valve Fitting	'4304413205	1
51	Electric Expand Valve Fitting	'4304413220	1
52	Strainer	'07212121	1
53	Silencer	'07245012	1
54	Condenser Sub-Assy	'0115410001901	1
55	Rear Grill	'01574100010	1

NO.	Name of Part	GMV-121WL/A-T GMV-121WL/C-T	
		Product Code	CN850W0420 CN850W0640
		Part Code	Quantity
56	Inhalation Tube Sub-Assy	'04574100067	1
57	Oil Separator	'07228302	1
58	Strainer	'07415200002	1
59	Discharge Tube Sub-Assy	'030013000499	1
60	Discharge Charge Valve	'07133771	1
61	Electronic Expansion Valve	'07334390	1
62	Electronic Expansion Valve	'07334447	1
63	Plate-type Heat Exchanger Assy	'00904100035	1
64	Sensor Sub-assy	'39008000060G	1
65	Electrical Heater	'765100047	1
66	Corrugated Pipe	'05015408	1

1) Model: GMV-120WL/A-T、GMV-140WL/A-T、GMV-160WL/A-T

Exploded view

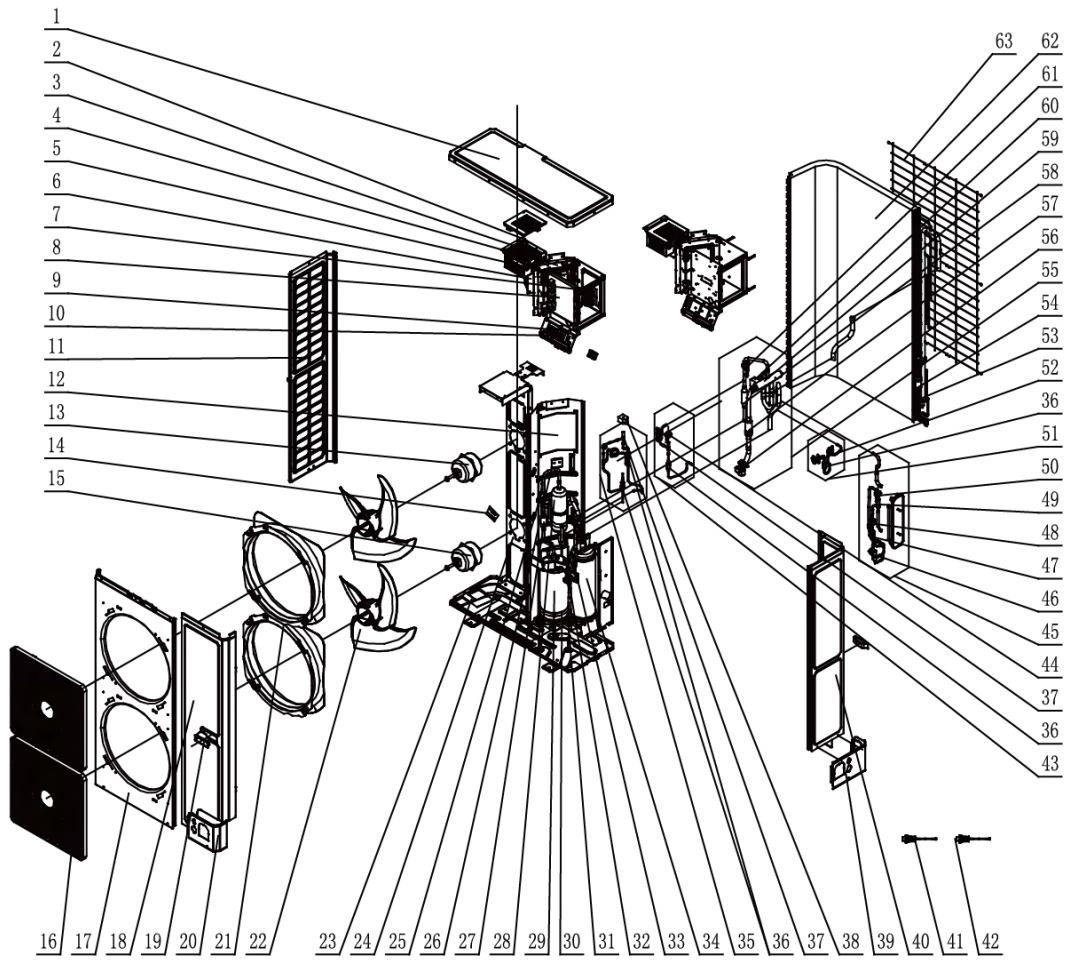

Parts list

NO.	Name of Part	GMV-120WL/A-T,GMV-140WL/A-T,GMV-160WL/A-T	
		Product Code	CN850W0180 /CN850W0170/CN850W0160
		Part Code	Quantity
1	Coping	01264100008P	1
2	Inductance Assy	01394100050	1
3	Inductance	43120122	1
4	Electric Box Assy	01394100124	1
5	Main Board	30228000005	1
6	Radiator	49018000013	1
7	Filter Board	30228000006	1
8	Main Board	30226000045	1
9	Terminal Board	42018000026	1
10	Terminal Board	42011242	1
11	Left Side Plate	01314100013P	1
12	Clapboard Sub-Assy	01244100006	1
13	Fan Motor	15704115	1
14	Sensor Sub-Assy	39008000061G	1
15	Fan Motor	1570411501	1
16	Front Grill	26904100026	1
17	Cabinet	01514100002P	1
18	Front Side Plate	01314100012P	1
19	Handle	26235253	1
20	Front Connection Board	01344100002P	1
21	Diversion Circle	10474100001	1
22	Axial Flow Fan	10434100003	1
23	Chassis Sub-Assy	0119410000301P	1
24	Motor Support Assy	01804100293	1
25	Pressure Protect Switch	4602000902	1
26	Discharge Tube Sub-Assy	04534100057	1
27	Silencer	07444105	1
28	Oil Separator	07424105	1
29	Compressor	00204100001	1
30	Electrical Heater(Compressor)	765152128	1
31	Compressor Gasket	76710247	1
32	Cut off Valve	07330000002	1
33	Strainer	07212001	1
34	Gas-liquid Separator	07424100014	1
35	Capillary Sub-Assy	04004100013	1
36	Strainer	07415200002	1

NO.	Name of Part	GMV-120WL/A-T,GMV-140WL/A-T,GMV-160WL/A-T	
		Product Code	CN850W0180 /CN850W0170/CN850W0160
		Part Code	Quantity
37	Electromagnetic Valve	43000054	1
38	Magnet Coil	4304000417	1
39	Right Connection Board	01344100003P	1
40	Rear Side Plate Sub-Assy	01314100011P	1
41	Sensing Device	322101001	1
42	Sensor (High Pressure)	322101032	2
43	Gas By-pass Sub- Assy	04534100056	2
44	Magnet Coil	4304000406	1
45	Plate-type Heat Exchanger Assy	00904100013	1
46	Discharge Charge Valve	07133771	1
47	Electronic Expansion Valve	07334447	1
48	Electric Expand Valve Fitting	4304413205	1
49	Electronic Expansion Valve	07334390	1
50	Electric Expand Valve Fitting	4304413220	1
51	Low Pressure Survey Valve Sub-Assy	07334100040	1
52	Cut off Valve	07130239	1
53	Strainer	07212121	1
54	Silencer	07245012	1
55	4-Way Valve Assy	04044100022	1
56	Cut off Valve	07330000001	1
57	Strainer	07210037	1
58	One way Valve	07130118	1
59	4-way Valve	43000338	1
60	Magnet Coil	4300040045	1
61	Nozzle for Adding Freon	06120012	1
62	Condenser Assy	01124100108	1
63	Rear Grill	01574100004	1

Above data is subject to change without notice, pls reference the SP in global service website.

2) Model: GMV-120WL/A-X、GMV-140WL/A-X、GMV-160WL/A-X
Exploded view

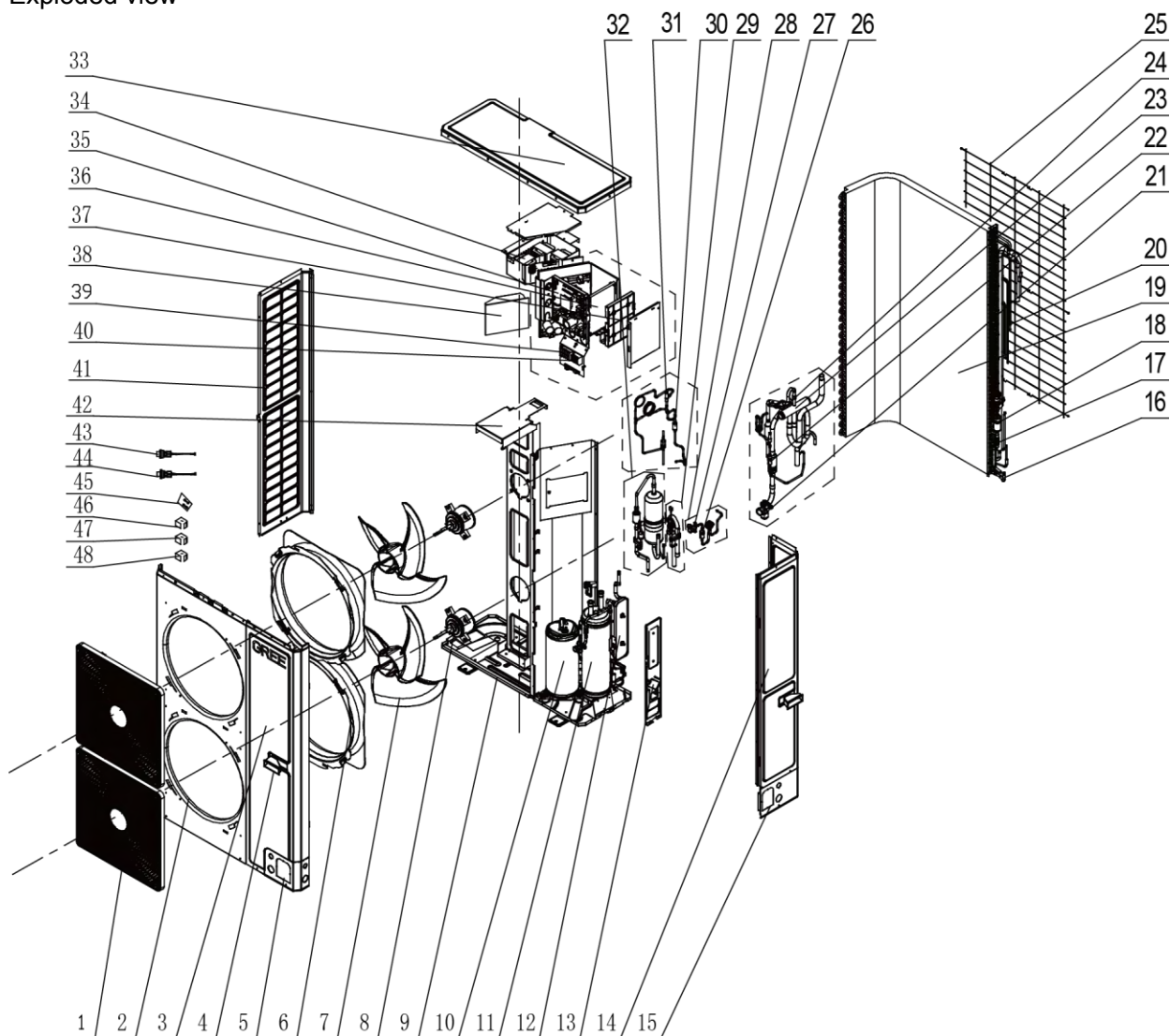

Parts list

NO.	Name of Part	GMV-120WL/A-X、GMV-140WL/A-X、GMV-160WL/A-X	
		Product Code	CN850W0260 / CN850W0250 / CN850W0240
		Part Code	Quantity
1	Front Grill	26904100026	2
2	Cabinet	01514100005	1
3	Front Side Plate	01314100012P	1
4	Handle	26235253	2
5	Front Connection Board	01344100002P	1
6	Diversion Circle	10474100001	2
7	Axial Flow Fan	1043410000301	1
8	Fan Motor	15704100013 1570410001301	2
9	Chassis Assy	0119410000301P	1
10	ompressor and Fittings	00204100018	1
11	Gas-liquid Separator	07424100014	1
12	Plate-type Heat Exchanger Assy	00904100013	1
13	Supporter	01804100312	1

NO.	Name of Part	GMV-120WL/A-X、GMV-140WL/A-X、GMV-160WL/A-X	
		Product Code	CN850W0260 / CN850W0250 / CN850W0240
		Part Code	Quantity
14	Rear Side Plate Sub-Assy	01314100011P	1
15	Right Connection Board	01344100003P	1
16	Current Divider	04414153	1
17	Strainer	07212121	1
18	Silencer	07245012	1
19	Condenser Sub-Assy	01154100008	1
20	Atmolysis Pipe Sub-Assy	04534100062	1
21	Cut off Valve	07330000001	1
22	Strainer	07212121	1
23	4-way Valve	43000338	1
24	Nozzle for Adding Freon	06120012	1
25	Rear Grill	01574100004	1
26	Strainer	07212121	1
27	Cut off Valve	07130239	1
28	Low Pressure Survey Valve Sub-Assy	07334100067	1
29	Inhalation Tube Sub-assy	04574100107	1
30	Strainer	07212121	1
31	Electromagnetic Valve	43000054	1
32	Discharge Tube Sub-Assy	04534100092	1
33	Coping	01264100008P	1
34	Reactor	43130192	1
35	Main Board	30226000046	1
36	Filter Board	30223000044	1
37	Electric Box Assy	26905200088	1
38	Radiator	49018000087	1
39	Terminal Board	42011221	1
40	Terminal Board	42018000026	1
41	Left Side Plate	01314100013P	1
42	Motor Support Sub-Assy	01805200244	1
43	Sensor (High Pressure)	322101032	1
44	Sensing Device	322101002	1
45	Sensor Sub-Assy	39008000061G	1
46	Magnet Coil	4304000417	1
47	Magnet Coil	4304000417	1
48	Magnet Coil	4304000417	1

Above data is subject to change without notice, pls reference the SP in global service website.

3) Model: GMV-120WL/C-T、GMV-140WL/C-T、GMV-160WL/C-T
Exploded view

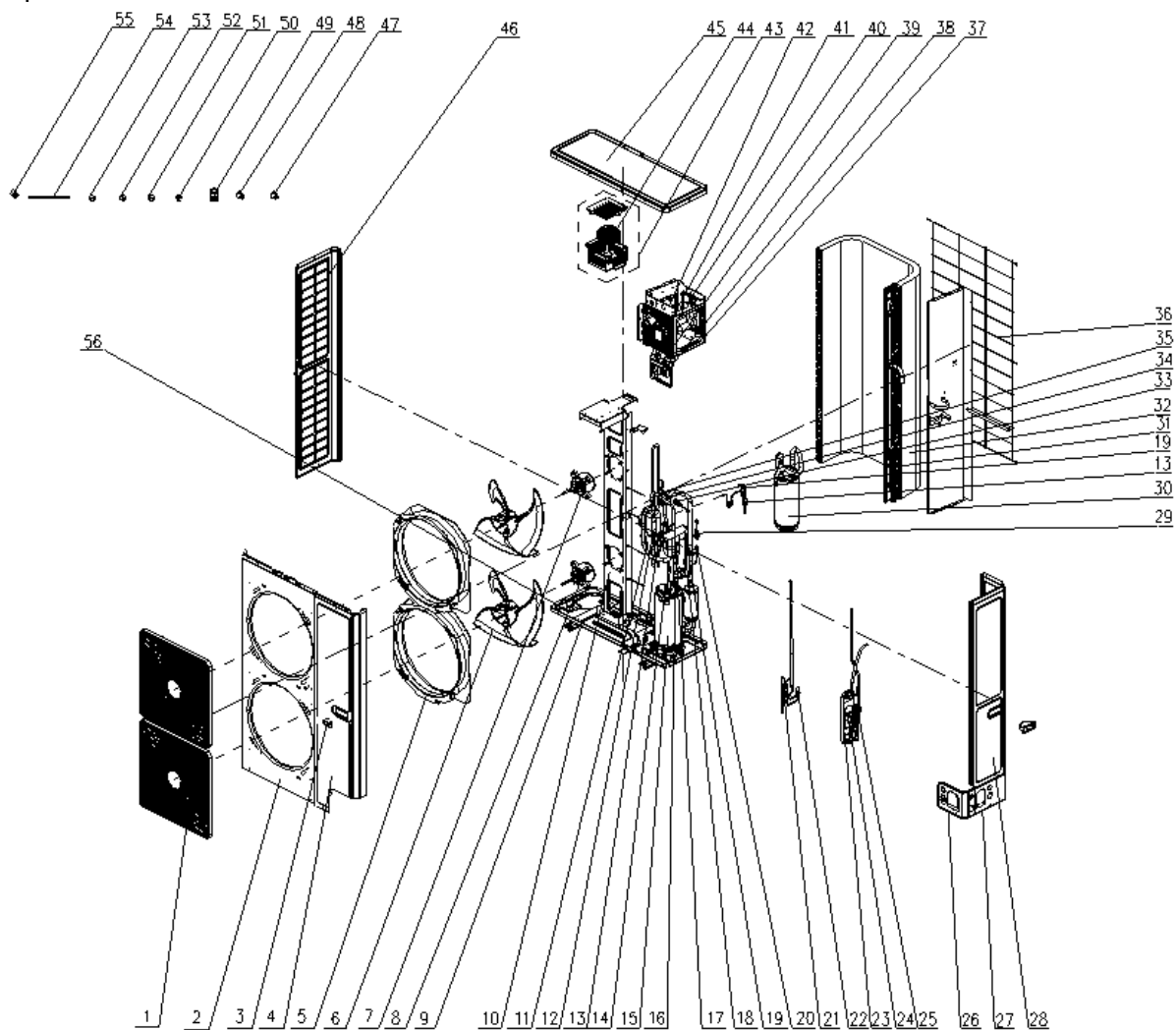

NO.	Name of Part	GMV-120WL/C-T、GMV-140WL/C-T、GMV-160WL/C-T
		Quantity
1	Front Grill	2
2	Cabinet	1
3	Handle	2
4	Front Side Plate	1
5	Diversion Circle	2
6	Axial Flow Fan	1
7	Brushless DC Motor	1
8	Brushless DC Motor	1
9	Chassis Sub-assy	1
10	Motor Support Sub-assy	1
11	Oil Separator	1
12	One way Valve	1
13	Strainer	1
14	Cut off Valve	1

NO.	Name of Part	GMV-120WL/C-T、GMV-140WL/C-T、GMV-160WL/C-T
		CN850W0440 CN850W0450 CN850W0460
		Quantity
15	Compressor and Fittings	1
16	Strainer	1
17	4-way Valve	1
18	Strainer	1
19	Electromagnetic Valve	1
20	Nozzle for Adding Freon	1
21	Electronic Expansion Valve	1
22	Discharge Charge Valve	1
23	Plate-type Heat Exchanger	1
24	Electronic Expansion Valve	1
25	Discharge Charge Valve	1
26	Front Connection Board	1
27	Right Connection Board	1
28	Rear Side Plate Sub-Assy	1
29	Sensor	1
30	Gas-liquid Separator	1
31	Strainer	1
32	Condenser Assy	1
33	Sensor(High Pressure)	1
34	Nozzle for Adding Freon	1
35	Pressure Protect Switch	1
36	Rear Grill	1
37	Electric Box Assy	1
38	Terminal Board	1
39	Terminal Board	1
40	Filter Board	1
41	Main Board	1
42	Main Board	1
43	Inductance Assy	1
44	Inductance	1
45	Coping	1
46	Left Side Plate	1
47	Electric Expand Valve Fitting	1
48	Electric Expand Valve Fitting	1
49	Communication Interface Board	1
50	Drainage Connector	1
51	Magnet Coil	1
52	Magnet Coil	1
53	Magnet Coil	1
54	Electrical Heater(Compressor)	1
55	Sensor Sub-Assy	1
56	Chassis Heater	1

4) Model: GMV-120WL/C-X、GMV-140WL/C-X、GMV-160WL/C-X

Exploded view

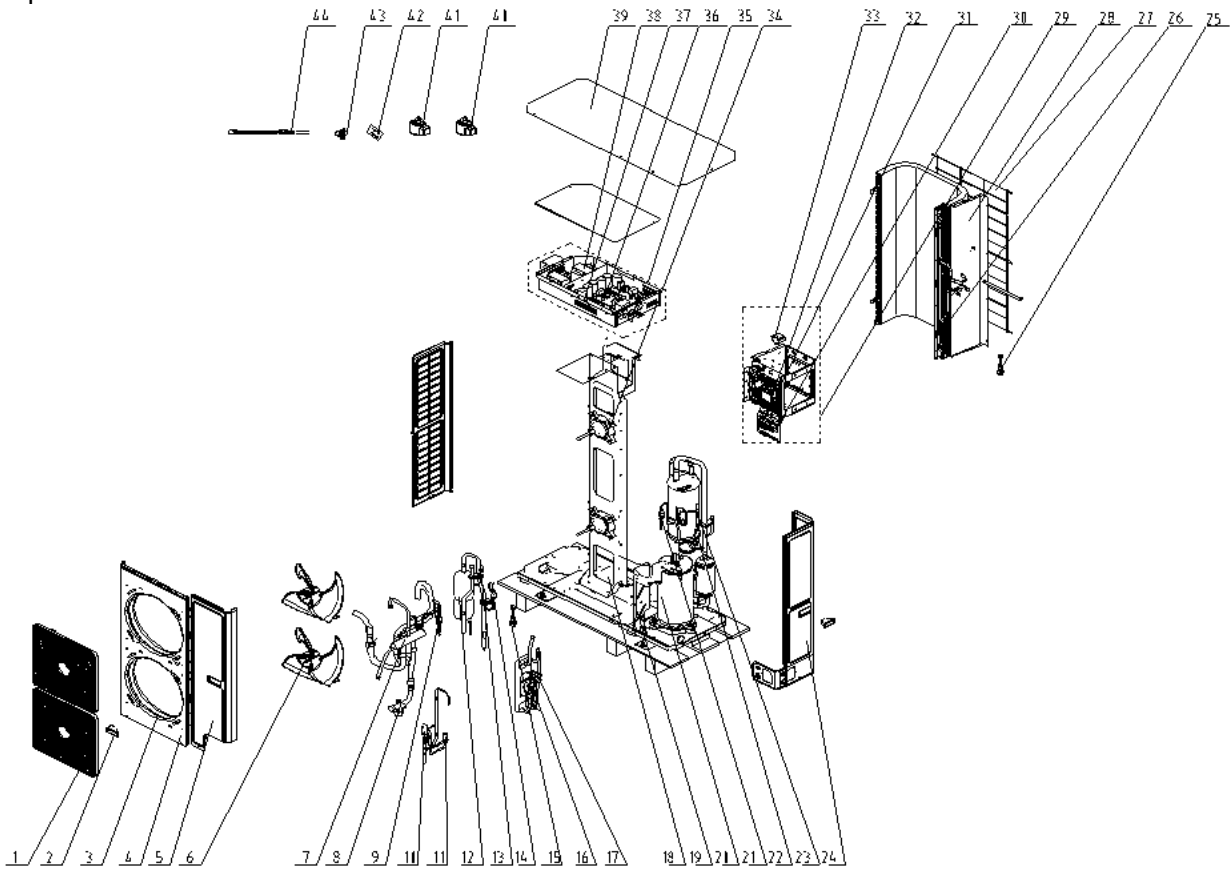

NO.	Name of Part	GMV-120WL/C-X、GMV-140WL/C-X、GMV-160WL/C-X	
		CN850W0470 CN850W0480 CN850W0490	
		Quantity	
1	Front Grill	2	
2	Handle	1	
3	Diversion Circle	1	
4	Cover	2	
5	Front Side Plate	1	
6	Axial Flow Fan	2	
7	4-way Valve	1	
8	Small Valve	2	
9	Strainer	1	
10	Electric Expand Valve Fitting	1	
11	Discharge Charge Valve	1	
12	Oil Separator	1	
13	Nozzle for Adding Freon	1	
14	High Pressure Circuit Breaker	1	
15	Pressure Sensor(High)	1	
16	Strainer	1	
17	Large valve	1	
18	Plate-type Heat Exchanger	1	
19	Supporter	1	
20	Compressor and Fittings	1	

NO.	Name of Part	GMV-120WL/C-X、GMV-140WL/C-X、GMV-160WL/C-X
		CN850W0470 CN850W0480 CN850W0490
		Quantity
21	Strainer	1
22	Strainer	1
23	Magnet Coil	1
24	Rear Side Plate Sub-Assy	1
25	Pressure Sensor(Low)	1
26	Strainer	1
27	Rear Grill	1
28	Condenser	1
29	Electric Box Assy	1
30	Terminal Board	1
31	Terminal Board	1
32	Main Board	1
33	Inductance	1
34	Brushless DC Motor	1
35	Electric Box Assy	1
36	Main Board	1
37	Radiator	1
38	Inductance	1
39	Top Cover	1
40	Magnet Coil	1
41	Magnet Coil	1
42	Sensor Sub-Assy	1
43	Drainage Connector	1
44	Chassis Heater	1

5) Model: GMV-H224WL/A-X,GMV-224WL/C-X

Exploded view

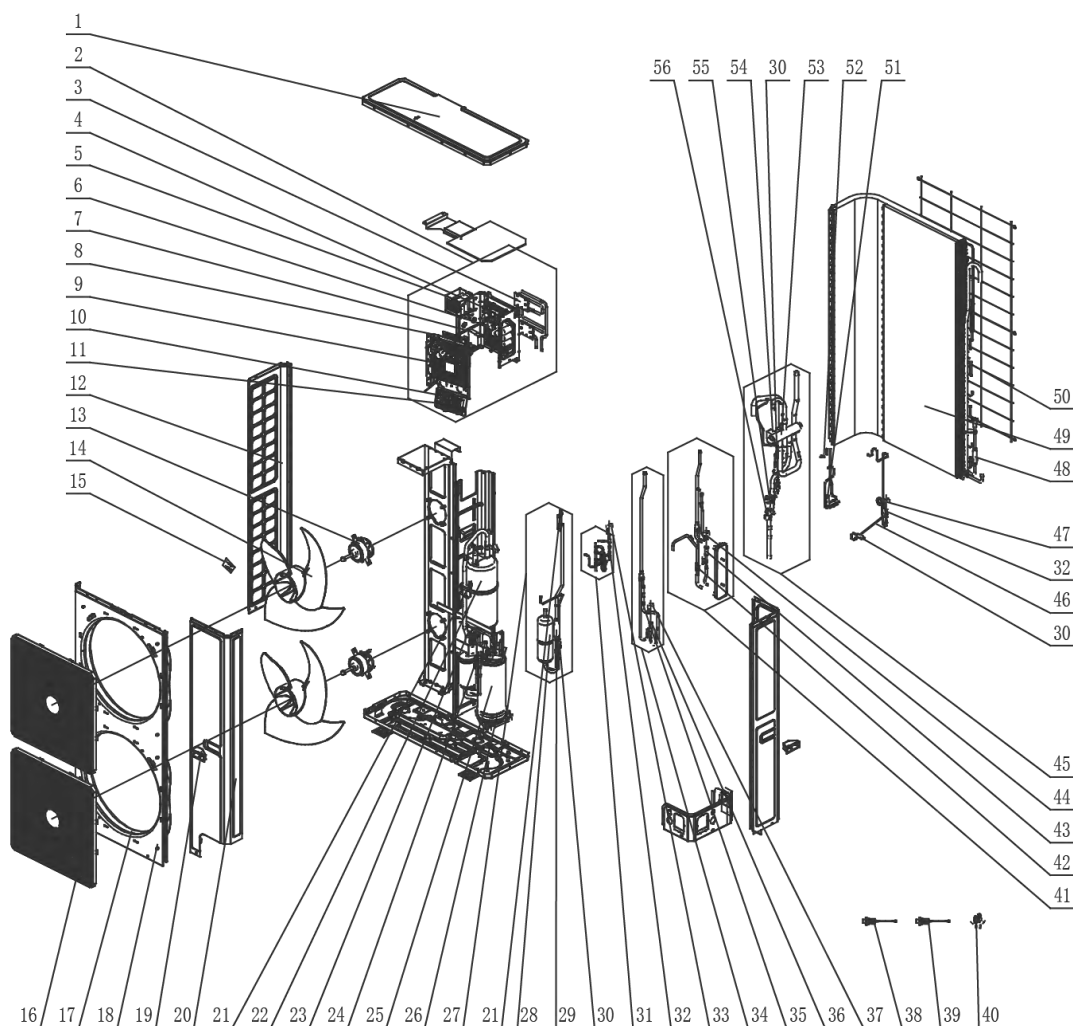

Parts list

NO.	Name of Part	GMV-H224WL/A-X,GMV-224WL/C-X	
		Product Code	CN850W0330
		Part Code	Quantity
1	Coping	01264100047P	1
2	Electric Box Assy	01394100349	1
3	Radiator	49018000083	2
4	Rectifier	46010604	1
5	Reactor	4313017401	1
6	Main Board	30223000045	1
7	Phase Reverse Protector	32218018	1
8	Filter Board	30228000015	1
9	Main Board	30226000045	1
10	Terminal Board	42011043	4
11	Terminal Board	42018000026	1
12	Left Side Plate	01314100084P	1
13	Fan Motor	1570280206	2
14	Axial Flow Fan	10434100006	2
15	Sensor Sub-assy	39008000061G	1
16	Front Grill	01574100008	2

NO.	Name of Part	GMV-H224WL/A-X,GMV-224WL/C-X	
		Product Code	CN850W0330
		Part Code	Quantity
17	Diversion Circle	10474100003	2
18	Cabinet Assy	01514100015	1
19	Handle	26235253	1
20	Front Side Plate	01314100082P	1
21	Nozzle for Adding Freon	06120012	1
22	Gas-liquid Separator	07424140	1
23	Pressure Protect Switch	4602000902	1
24	Cut off Valve	07334100011	1
25	Compressor and Fittings	00204100013	1
26	Electrical Heater(Compressor)	765152128	1
27	Oil Separator Sub-Assy	07424100045	1
28	Oil Separator	07424105	1
29	One way Valve	07130118	1
30	Strainer	07415200002	1
31	Capillary Sub-assy	04004100020	1
32	Electromagnetic Valve	43000054	1
33	Magnet Coil	4304000417	1
34	Electric Expansion Valve Sub-Assy	43044100160	1
35	One Way Valve	07133618	1
36	Electronic Expansion Valve	43044100173	1
37	Electric Expand Valve Fitting	4304413219	1
38	Sensor (High Pressure)	322101032	1
39	Sensing Device	322101002	1
40	Drainage Joint	26113009	1
41	Plate-type Heat Exchanger Assy	00904100025	1
42	Strainer	07212001	1
43	Electronic Expansion Valve	3044100172	1
44	Electric Expand Valve Fitting	4304413220	1
45	4-Way Valve Sub-Assy	04044100059	1
46	Gas By-pass sub-assy	04534100101	1
47	Magnet Coil	4304000416	1
48	Strainer	07212403	1
49	Condenser Assy	01124100138	1
50	Rear Grill	01574100011	1
51	Discharge Charge Valve	07133771	1
52	Discharge Charge Valve Sub-Assy	07334100062	1
53	4-Way Valve	43044100164	1
54	Magnet Coil	4300040032	1
55	Cut off Valve	07130239	1
56	Cut off Valve	07334100054	1

Above data is subject to change without notice, pls reference the SP in global service website.

6) Model: GMV-H280WL/A-X,GMV-280WL/C-X
Exploded view

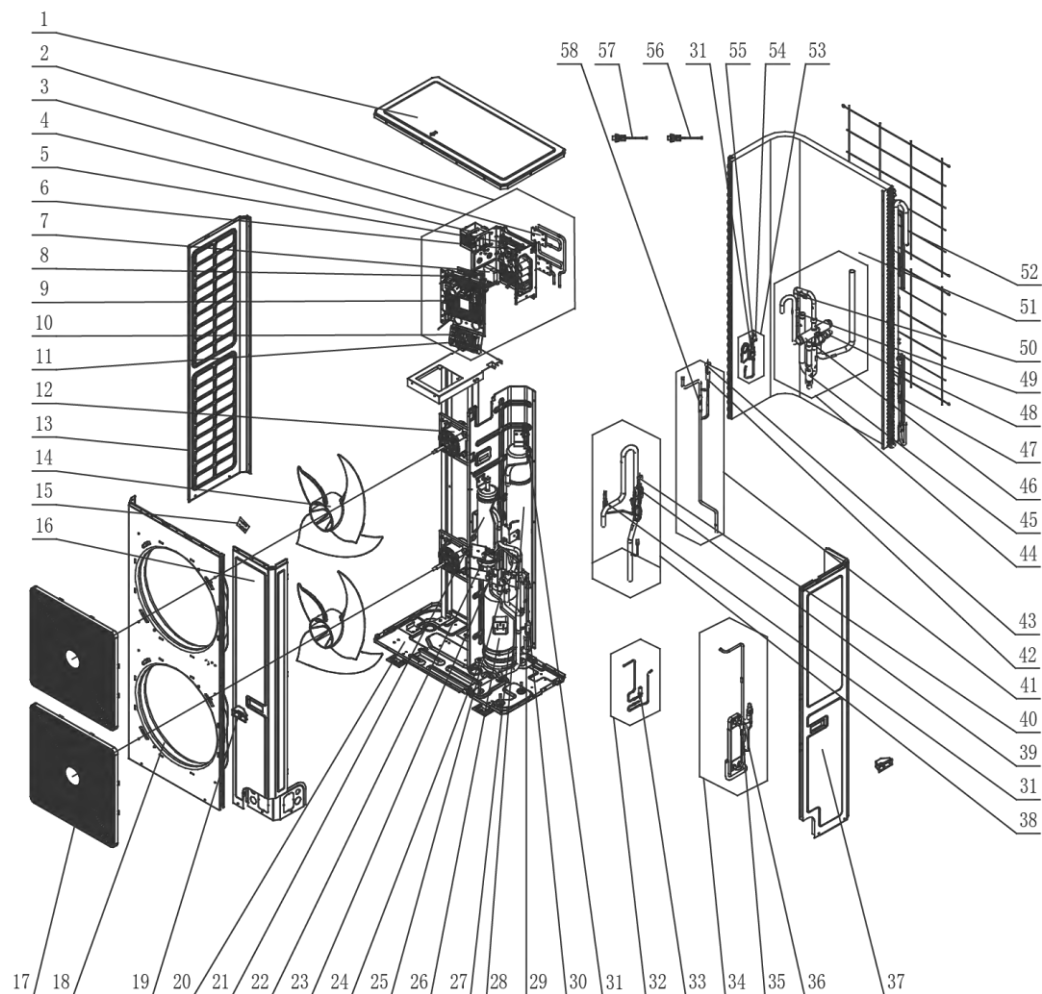

Parts list

NO.	Name of Part	GMV-H280WL/A-X,GMV-280WL/C-X	
		Product Code	CN850W0340
		Part Code	Quantity
1	Coping	01264100052P	1
2	Electric Box Assy	01394100496	1
3	Radiator	49018000083	2
4	Reactor	4313017401	1
5	Main Board	30223000072	1
6	Rectifier	46010604	1
7	Phase Reverse Protector	32214101	1
8	Filter Board	30223000025	1
9	Main Board	30226000066	1
10	Terminal Board	42011043	1
11	Terminal Board	42018000026	1
12	Brushless DC Motor	15704100010	2
13	Left Side Plate	01314100090P	1
14	Axial Flow Fan	10434100008	2
15	Sensor Sub-Assy	39008000121G	1
16	Front Side Plate	01314100091P	1

NO.	Name of Part	GMV-H280WL/A-X,GMV-280WL/C-X	
		Product Code	CN850W0340
		Part Code	Quantity
17	Front Grill	01574100008	2
18	Diversion Circle	10474100003	2
19	Handle	26235253	2
20	Chassis Assy	01194100112	1
21	Oil Separator	07424100050	1
22	Cut off Valve	07130208	1
23	Cut off Valve	07334100011	1
24	Compressor Gasket	76715019	4
25	Cut off Valve	07334100012	1
26	Compressor and Fittings	00204100023	1
27	Electric Heater(Compressor)	7651540714	1
28	Gas-liquid Separator	07424100048	1
29	Pressure Protect Switch	4602000902	1
30	Bidirection Strainer	07220016	1
31	Strainer	07415200002	1
32	Discharge Charge Valve Sub-Assy	07334100066	1
33	Discharge Charge Valve	07133771	1
34	Plate-type Heat Exchanger Assy	00904100029	1
35	Electronic Expansion Valve	43044100172	1
36	Electric Expand Valve Fitting	4304413204	1
37	Rear Side Plate	01314100092P	1
38	Inhalation tube Assy	04574100168	1
39	Electromagnetic Valve	43003091	1
40	Magnet Coil	4304000413	1
41	Electric Expansion Valve Sub-Assy	43044100237	1
42	Electronic Expansion Valve	43044100173	1
43	Electric Expand Valve Fitting	4304413205	1
44	4-Way Valve Assy	04044100081	1
45	Strainer	07414100026	1
46	4-way Valve	43000339	1
47	Strainer	07212121	1
48	Magnet Coil	4300040032	1
49	One way Valve	07335210	1
50	Nozzle for Adding Freon	06120012	1
51	Condenser Assy	01124100160	1
52	Rear Grill	01574100014	2
53	Gas By-pass sub- assy	04534100108	1
54	Magnet Coil	4304000416	1
55	Electromagnetic Valve	43000054	1
56	Sensor (High Pressure)	322101032	1
57	Sensor	322101002	1
58	One way Valve	04324001	1

Above data is subject to change without notice, pls reference the SP in global service website.

7) Model: GMV-H335WL/A-X,GMV-335WL/C-X
Exploded view

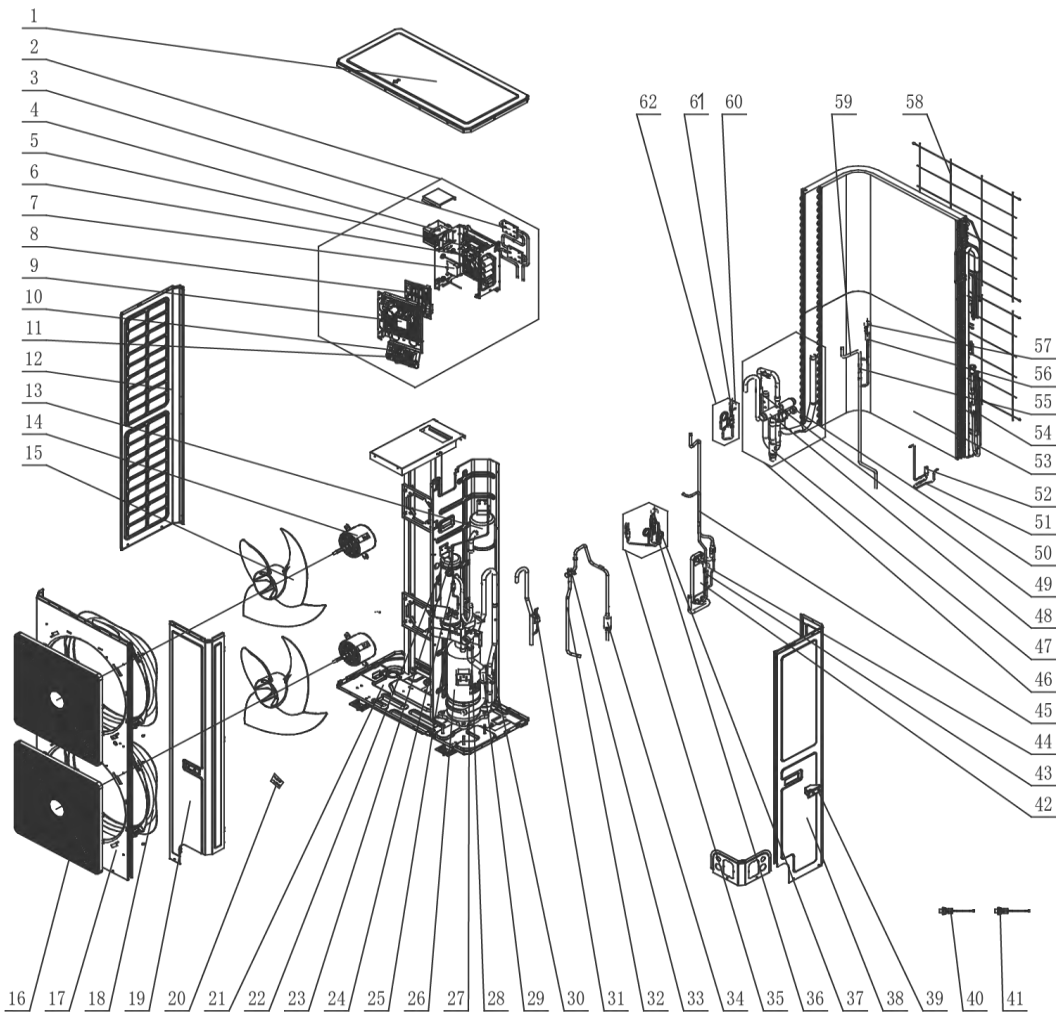

Parts list

NO.	Name of Part	GMV-H335WL/A-X,GMV-335WL/C-X	
		Product Code	CN850W0350
		Part Code	Quantity
1	Coping	01264100052P	1
2	Electric Box Assy	01394100496	1
3	Radiator	49018000083	2
4	Reactor	4313017401	1
5	Rectifier	46010604	1
6	Main Board	30223000072	1
7	Phase Reverse Protector	32214101	1
8	Filter Board	30223000025	1
9	Main Board	30226000066	1
10	Terminal Board	42011043	1
11	Terminal Board	42018000026	1
12	Left Side Plate	01314100090P	1
13	Gas-liquid Separator	07424100048	1
14	Brushless DC Motor	15704100010	2
15	Axial Flow Fan	10434100008	2
16	Front Grill	01574100008	2
17	Cabinet	01514100016P	1
18	Diversion Circle	10474100003	2

NO.	Name of Part	GMV-H335WL/A-X,GMV-335WL/C-X	
		Product Code	CN850W0350
		Part Code	Quantity
19	Front Side Plate	01314100091P	1
20	Sensor Sub-assy	39008000121G	1
21	Chassis Sub-assy	01194100081P	1
22	Oil Separator	07424100050	1
23	Low Pressure Survey Valve Sub-assy	07334100065	1
24	Strainer	07414100024	1
25	Cut off Valve	07130208	1
26	Compressor and Fittings	00204100015	1
27	Electric Heater(Compressor)	7651540714	1
28	Cut off Valve	07334100014	1
29	Connecting Pipe Sub-assy(Big Vavle)	05024100925	1
30	Nozzle for Adding Freon	06120012	1
31	Pressure Protect Switch	4602000902	1
32	Connection Pipe Sub-assy	05024100948	1
33	Cut off Valve	07334100013	1
34	Strainer	07210032	1
35	Capillary Sub-assy	04004100022	1
36	Electromagnetic Valve	43003091	1
37	Magnet Coil	4304000413	1
38	Rear Side Plate	01314100092P	1
39	Handle	26235253	2
40	Sensor (High Pressure)	322101032	1
41	Sensing Device	322101002	1
42	Plate-type Heat Exchanger	00904100004	1
43	Electronic Expansion Valve	43044100172	1
44	Electric Expand Valve Fitting	4304413204	1
45	Plate-type Heat Exchanger Assy	00904100029	1
46	4-Way Valve Assy	04044100061	1
47	Strainer	07414100024	1
48	4-way Valve	43000339	1
49	One way Valve	07335210	1
50	Magnet Coil	4300040032	1
51	Discharge Charge Valve Sub-Assy	07334100066	1
52	Discharge Charge Valve	07133771	1
53	Condenser Assy	01124100151	1
54	Filter	0341010701	1
55	One way Valve	04324001	1
56	Electronic Expansion Valve	43044100190	1
57	Electric Expand Valve Fitting	4304413205	1
58	Rear Grill	01574100014	2
59	Electric Expansion Valve Sub-Assy	43044100211	1
60	Magnet Coil	4304000416	1
61	Electromagnetic Valve	43000054	1
62	Gas By-pass sub- assy	04534100108	1

Above data is subject to change without notice, pls reference the SP in global service website.



JF00302323



GREE ELECTRIC APPLIANCES, INC. OF ZHUHAI 519070

Add: West Jinji Rd, Qianshan Zhuhai, Guangdong, China

Tel: (+86-756)8522218

Fax: (+86-756)8669426

E-mail: gree@gree.com.cn www.gree.com