



# ***Technical Sales Guide***

## **DC INVERTER MULTI VRF INDOOR UNIT**

(GC202306-XXV)



# CONTENTS

1.PRODUCT CHARACTERISTIC .....	1
2.UNIT PARAMETERS.....	10
3.ELECTRICAL SPECIFICATIONS.....	67
4.COOLING/HEATING CAPACITY CORRECTION .....	78
5.UNIT NOISE CURVES .....	101
6.FAN CHARACTERISTICS.....	145
7.UNIT INSTALLATION SPACE REQUIREMENTS .....	167
8.REQUIREMENTS FOR COMMUNICATION MODE .....	220
9.OPTIONAL COMPONENTS.....	224

EU417101



## 1 PRODUCT CHARACTERISTIC

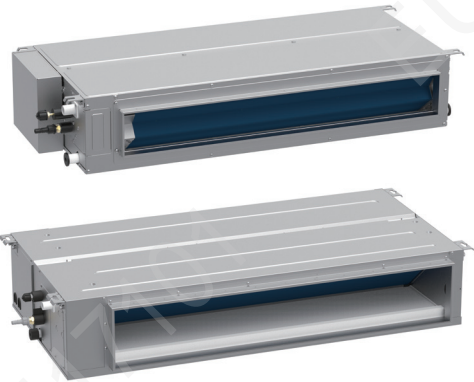

### 1.1 General static pressure Duct Type Indoor Unit

Appearance	Characteristic
	<ul style="list-style-type: none"> <li>◆ Capacity range 1.8-14kW.</li> <li>◆ External static pressure up to 80 (50) Pa.</li> <li>◆ Condensate drain pump, maximum lift height up to 1.2m.</li> <li>◆ Multiple protections: anti-freezing protection, temperature sensor fault protection and other multiple guarantees.</li> </ul>



### 1.2 Four-way Cassette Type Indoor Unit

Appearance	Characteristic
	<ul style="list-style-type: none"> <li>◆ Strong and balanced airflow. Unit features auto operation, Four-way airflow, 7 fan speeds and strong circulating airflow.</li> <li>◆ DC inverter motor With good speed regulation performance, motor efficiency improved by 30% vs. normal motor.</li> <li>◆ Ultra-low noise operation DC inverter motor can realize stepless speed regulation to lower noise. Indoor unit can be set to work under auto quiet mode via wired controller.</li> <li>◆ Protection function Water overflow protection, anti-freezing protection, temperature sensor malfunction protection, fan motor overload protection.</li> <li>◆ Intelligent drainage device The drain pump lift is up to 1.2m, which can effectively drain out condensing water which is convenient for installation.</li> </ul>

### 1.3 One-way Cassette Type Indoor Unit

Appearance	Characteristic
	<ul style="list-style-type: none"> <li>◆ 178mm ultra-thin unit body.</li> <li>◆ Removable grille, long-acting filter.</li> <li>◆ Standard fitting 1.2m condensate drain pump lift.</li> <li>◆ High ceiling adaptable, suitable for ceiling height up to 3.5m.</li> </ul>
	<ul style="list-style-type: none"> <li>◆ 200mm ultra-thin unit body.</li> <li>◆ Ultra wide angle air supply.</li> <li>◆ Uniform temperature distribution and high comfort.</li> <li>◆ Evaporator auto-drying operation.</li> <li>◆ Quiet Fan blade design, low noise operation.</li> <li>◆ Hidden light panel design.</li> </ul>

### 1.4 Floor Ceiling Type Indoor Unit

Appearance	Characteristic
	<ul style="list-style-type: none"> <li>◆ Flexible installation, the unit can be ceiling or floor mounted.</li> <li>◆ Air louver can swing up and down for wide air supply range.</li> </ul>
	<ul style="list-style-type: none"> <li>◆ The unit can be ceiling or floor mounted. When floor mounted, a suspended ceiling is not needed.</li> <li>◆ With beautiful and elegant front panel, it is congenial to the indoor surroundings.</li> <li>◆ Wider air swing range for your comfortable working and living environment.</li> </ul>

## 1.5 Slim Duct Type Indoor Unit

Appearance	Characteristic
	<ul style="list-style-type: none"> <li>◆ <b>Highly Efficient &amp; Energy-saving</b> High-efficiency DC brushless motor is used. Its efficiency is improved by over 30% compared with common motor. Evaporator flow path adopts simulating optimized design via the refrigeration system simulation software, which has greatly increased the heat exchange capacity of evaporator.</li> <li>◆ <b>Slim &amp; Compact</b> The unit is only 200 mm thick and 450 mm deep. Suspended ceiling doesn't have to be very high. It is suitable for ordinary rooms.</li> <li>◆ <b>Wiring of Electric Control Box</b> Mounting board of electric control box elements are arranged at both sides of the mounting board of fan motor. There is a wire-cross notch on each side so that wiring at both sides of the mounting board of fan motor is convenient and efficient. Strong and weak current are also separated to ensure the effectiveness of weak current signal transmission.</li> <li>◆ <b>Protection Functions</b> Anti-freezing protection, fan motor built-in overload protection, temperature sensor protection.</li> <li>◆ <b>Ultra-quiet</b> Adopt Patented high-efficiency centrifugal fan and ultra-low noise volute. Meanwhile, inlet noise attenuating valve is adopted so that noise unit is further reduced.</li> <li>◆ <b>Fast &amp; Strong</b> Intelligent temperature control technology is adopted which enables fast and strong cooling/heating performance.</li> <li>◆ <b>Flexible Installation</b> Based on the requirements of building and utilization, different ways of air return and different air supply static pressure can be selected.</li> <li>◆ <b>CAN Bus Communication Technology</b> System response speed is faster and communication is more reliable. Auto addressing, non-polar communication, easy wire matching.</li> <li>◆ <b>Convenient Operation &amp; Maintenance</b> Electric control box is attached independently so that it can be detached as a whole, which is convenient for service and maintenance.</li> </ul>

### 1.6 Wall Mounted Type Indoor Unit

Appearance	Characteristic
	<ul style="list-style-type: none"> <li>◆ Cleanable filter The filter is removable and can be cleaned for easy maintenance.</li> <li>◆ Quiet design High-efficiency cross flow fan and low-noise EXV are adopted, which greatly reduce the noise of entire unit.</li> <li>◆ One IDU with several wired controller and several IDUs with one wired controller One IDU can be connected with several wired controllers in order to control one IDU from different location; meanwhile, several IDUs can be connected with one wired controller in order to achieve centralized control of 16 IDUs in maximum.</li> <li>◆ Wide air supply range The air supply range is wide, so that the wind can be delivered to each corner of the room naturally and evenly.</li> <li>◆ Super cooling and heating function Intelligent temperature control technology is adopted with super cooling and heating function, so that the room temperature can reach set temperature rapidly.</li> <li>◆ I-feel function When I-feel function is activated, the unit can detect the temperature around the user and adjust the temperature, so that the comfort of user is improved. (Wireless remote controller shall be equipped)</li> <li>◆ Panel is removable The panel of indoor unit can be removed easily for convenient maintenance.</li> <li>◆ Multiple protections Anti-freezing protection, temperature sensor malfunction protection, fan motor overload protection.</li> </ul>

## 1.7 Fresh air Processing Type Indoor Unit

Appearance	Characteristic
	<ul style="list-style-type: none"> <li>◆ One system, two functions Adopted with DC inverter technology fresh air indoor unit features air conditioning function and fresh air function.</li> <li>◆ Less investment Fresh air indoor unit can be combined with GMV outdoor unit. For a same room, if the same amount of fresh air is to be taken, the cost of fresh air indoor unit is lower than that of equivalent solution which consist of common indoor unit + ventilator.</li> <li>◆ Less operation cost Unit can control cooling output according to actual needs to ensure constant airflow temperature, to avoid energy wasting especially during the transit season. Thus, operation cost can be greatly reduced.</li> <li>◆ Less installation space Save installation space for outdoor units. Especially suitable for places that have restricted installation space.</li> </ul>

## 1.8 Console Type IDU

Appearance	Characteristic
	<ul style="list-style-type: none"> <li>◆ Multiple fan speed The fan can operate in multiple speeds and satisfy different air flow volume requirements.</li> <li>◆ High drain pump lift Drain pump lift reaches 1.2m, which can effectively drain out water.</li> <li>◆ Detachable grille and long life filter Grille is detachable for easy cleaning. With long life filter, cleaning cycle is 20 times longer than the conventional one.</li> <li>◆ Protection function Anti-freezing protection, fan motor overload protection, temperature sensor malfunction protection, auxiliary electric heating overheat protection (This function is not included in pure heat pump unit).</li> </ul>

## 1.9 Floor Standing Type Indoor Unit

Appearance	Characteristic
	<ul style="list-style-type: none"> <li>◆ Wide Application It can be widely adopted in hotels, restaurants, office, etc.</li> <li>◆ Auto clean to ensure a healthy life After turning off the unit, the indoor fan will keep running in low speed for a moment to dry the inner components and parts, in order to prevent mildew and provide clean air.</li> </ul>

### 1.10 Compact Four-way Cassette Type Indoor Unit

Appearance	Characteristic
	<ul style="list-style-type: none"> <li>◆ Compact design for easy installation Units maintain the uniform length and width with consistent ceiling opening and panel dimension, convenient for design and installation.</li> <li>◆ Ultra-low noise operation DC inverter motor can realize step less speed regulation to lower noise. Indoor unit can be set to work under auto quiet mode via wired controller.</li> <li>◆ Intelligent drainage device The drain pump lift up to 1.2m, which can effectively drain out condensing water which is convenient for installation.</li> </ul>

### 1.11 360° Air Discharge Compact Cassette Indoor Unit

Appearance	Characteristic
	<ul style="list-style-type: none"> <li>◆ Independent Swing Control.</li> <li>◆ 360° Air Supply.</li> <li>◆ DC quiet drain pump.</li> <li>◆ DC motor design for more energy-saving operation.</li> <li>◆ Multiple protection functions for safe and reliable operation.</li> <li>◆ New designed air duct and fan blade for lower operating noise.</li> <li>◆ Compact design for more convenient installation.</li> </ul>



## 1.12 AHU-KIT Type

Appearance	Characteristic
	<ul style="list-style-type: none"> <li>◆ Can be conveniently controlled via the third party controller AHU-KIT adapter can be controlled via Gree wired controller, and can also be controlled via the third party controller by adjusting DIP switch, which can realize ON/OFF control, mode setting, temperature adjustment, feedback of unit operating status, etc.</li> <li>◆ Equipped the air handling unit with functions and advantages of VRF products Connected to VRF system of air handling unit and retained the original user function and project application function of VRF system. Installation, debugging, operation and maintenance are more convenient.</li> <li>◆ Multiple installation method for convenient project design The air handling unit equipped with AHU-KIT has multiple methods for connecting VRF system. It can independently connect to VRF system to compose a one-to-one proposal; it can also match with other air handling unit or common VRF indoor units to connect to the same VRF system for composing a one-to-more proposal. In this case, it is convenient for project design.</li> <li>◆ Independent design, convenient installation AHU-KIT is composed by two independent boxes( electronic expansion valve and control box) and designed independently, which is convenient for installation and application.</li> <li>◆ Error protection Error signal of air handling unit will be sent to AHU-KIT. When there's malfunction, the unit will stop operation, for unit safety and reliability.</li> <li>◆ Dual control type It can be controlled according to normal indoor unit and also according to fresh air indoor unit.</li> </ul>

## 1.13 Two-way Cassette Type Indoor Unit

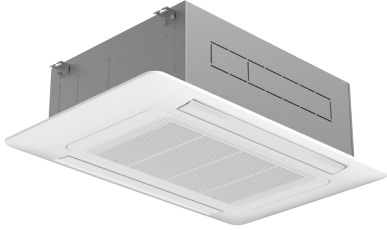
Appearance	Characteristic
	<ul style="list-style-type: none"> <li>◆ Two-way air supply Two-way air outlet, to stretch air outlet distance and meet air supply requirement of elongated room perfectly.</li> <li>◆ New streamlined appearance design The new generation of two-way cassette unit adopts a new front panel design, making it visually pleasing and perfectly fit into indoor decoration.</li> <li>◆ Independent swing control There are two air deflectors that can be controlled independently to adjust the air supply direction. They can make different combinations of air swing angles to avoid direct airflow to people. *It must be used with the wired controller (XE70-33/H).</li> <li>◆ Automatic louver control The front panel adopts an arc design for air deflectors. With structural simulation of the best air supply angle. In cooling mode, the unit can achieve horizontal air supply. In heating mode, it can achieve vertical air supply.</li> <li>◆ Standard fitting condensate drain pump with 1200mm lift.</li> <li>◆ Quiet fan blade design, low noise operation</li> <li>◆ Compact body design</li> </ul>

### 1.14 Air Handler type Indoor Unit

Appearance	Characteristic
	<ul style="list-style-type: none"> <li>◆ Highly flexible installation The unit is designed for outdoor installation and less indoor space taking, allowing easy installation and maintenance. The unit can be installed on the ground or on the roof of the building, which means the installation is totally flexible depending on the project requirement.</li> <li>◆ Cold air prevention design When heating in winter, cold air prevention function is enabled so that air won't be blown out until it's warm.</li> <li>◆ Long life and washable filter The filter is easy to be dismantled and installed. You can use dust collector or water to clear away the dust.</li> </ul>

### 1.15 Super High Static Pressure Duct Type Indoor Unit

Appearance	Characteristic
	<ul style="list-style-type: none"> <li>◆ External static pressure can be up to 200Pa.</li> <li>◆ Standard fitting condensate drain pump with 1200mm lift.</li> <li>◆ Optional PM2.5 electrostatic fiber filter.</li> <li>◆ 9-grade static pressure for adjustment, convenient for engineering application.</li> </ul>

### 1.16 Concealed Floor Standing Type Indoor Unit

Appearance	Characteristic
	<ul style="list-style-type: none"> <li>◆ Capacity range: 2.2~7.1kW.</li> <li>◆ Compact structure, ultra-thin unit body, only 200mm thickness in vertical installation.</li> <li>◆ Different grades of static pressure for adjustment, highest static pressure can be up to 60Pa.</li> <li>◆ Flexible installation, supporting feet design in different height, and can realize flexible switch of bottom air return and side air return.</li> </ul>



## 1.17 360° Air Discharge Cassette Indoor Unit

Appearance	Characteristic
	<ul style="list-style-type: none"> <li>◆ 360° Air Supply 360° air supply design for balanced temperature distribution, which provides more comfortable experience.</li> <li>◆ Independent Swing Control 4 swing blades can be controlled independently and maximum 625 air supply angle combinations can be realized for free and humanized control, avoiding direct blow to people.</li> <li>◆ Ultra-low Noise Operation DC inverter motor can realize step less speed regulation to lower noise indoor unit, it can be set to work under auto quiet mode via wired controller.</li> <li>◆ Intelligent Drainage Device The drain pump lift up to 1.2m, which can effectively drain out condensing water which is convenient for installation.</li> </ul>

## 1.18 Heat Storage Module

Appearance	Characteristic
	<ul style="list-style-type: none"> <li>◆ Auxiliary defrosting device The heat storage module can assist defrosting. The defrosting time of air conditioner with this module is shorter, the temperature fluctuation in the room is smaller during defrosting.</li> <li>◆ Easy maintenance The system has maintenance access panel for easy maintenance.</li> </ul>

## 1.19 High Static Pressure Duct Type Indoor Unit

Appearance	Characteristic
	<ul style="list-style-type: none"> <li>◆ External static pressure can be up to 200Pa</li> <li>◆ Standard fitting condensate drain pump with 1200mm lift.</li> <li>◆ Optional PM2.5 electrostatic fiber filter</li> <li>◆ 9-grade static pressure for adjustment, convenient for engineering application</li> </ul>

## 1.20 Middle Static Pressure Duct Type Indoor Unit

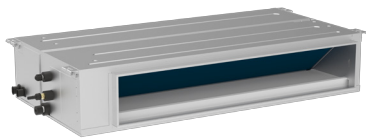
Appearance	Characteristic
	<ul style="list-style-type: none"> <li>◆ External static pressure can be up to 80Pa</li> <li>◆ 5-grade static pressure for adjustment, convenient for engineering application</li> </ul>

## 2 UNIT PARAMETERS

### 2.1 General static pressure Duct Type Indoor Unit

Model		GMV-ND18PLS/C-T	GMV-ND22PLS/C-T	GMV-ND25PLS/C-T	GMV-ND28PLS/C-T	GMV-ND32PLS/C-T	GMV-ND36PLS/C-T
Cooling capacity	kW	1.8	2.2	2.5	2.8	3.2	3.6
Heating capacity	kW	2.2	2.5	2.8	3.2	3.6	4.0
Air volume	m <sup>3</sup> /h	450	450	450	450	550	550
Unit external static pressure	Pa	15/0~30	15/0~30	15/0~30	15/0~30	15/0~30	15/0~30
Cooling power input	W	28	28	28	28	37	37
Cooling current input	A	0.2	0.2	0.2	0.2	0.3	0.3
Heating power input	W	25	25	25	25	30	30
Heating current input	A	0.2	0.2	0.2	0.2	0.3	0.3
*Minimum line current	A	0.4	0.4	0.4	0.4	0.4	0.4
*Maximum fuse current	A	6	6	6	6	6	6
Sound pressure level	dB(A)	30	30	30	30	31	31
Power supply		220-240V ~50Hz & 208-230V ~60Hz					
Piping connection	Liquid pipe	mm	Φ6.35	Φ6.35	Φ6.35	Φ6.35	Φ6.35
	Gas pipe	mm	Φ9.52	Φ9.52	Φ9.52	Φ9.52	Φ12.7
Drain pipe	External diameter × thickness	mm	Φ25×2.5	Φ25×2.5	Φ25×2.5	Φ25×2.5	Φ25×2.5
Dimensions	W×D×H	mm	710×462×200	710×462×200	710×462×200	710×462×200	710×462×200
Net weight	Main body	kg	18.5	18.5	18.5	18.5	19

Model		GMV-ND40PLS/C-T	GMV-ND45PLS/C-T	GMV-ND50PLS/C-T	GMV-ND56PLS/C-T	GMV-ND63PLS/C-T	GMV-ND71PLS/C-T
Cooling capacity	kW	4.0	4.5	5.0	5.6	6.3	7.1
Heating capacity	kW	4.5	5.0	5.6	6.3	7.1	8.0
Unit external static pressure	Pa	15/0~30	15/0~30	15/0~30	15/0~30	15/0~30	15/0~50
Air volume	m <sup>3</sup> /h	750	750	850	850	850	1100
Cooling power input	W	40	40	55	55	55	55
Cooling current input	A	0.3	0.3	0.4	0.4	0.4	0.5
Heating power input	W	35	35	45	45	45	50
Heating current input	A	0.3	0.3	0.4	0.4	0.4	0.5
*Minimum line current	A	0.4	0.4	0.6	0.6	0.6	0.8
*Maximum fuse current	A	6	6	6	6	6	6
Sound pressure level	dB(A)	33	33	35	35	35	37
Power supply		220-240V ~50Hz & 208-230V ~60Hz					
Piping connection	Liquid pipe	mm	Φ6.35	Φ6.35	Φ6.35	Φ9.52	Φ9.52
	Gas pipe	mm	Φ12.7	Φ12.7	Φ12.7	Φ15.9	Φ15.9
Drain pipe	External diameter × thickness	mm	Φ25×2.5	Φ25×2.5	Φ25×2.5	Φ25×2.5	Φ25×2.5
Dimensions	W×D×H	mm	1010×462×200	1010×462×200	1010×462×200	1010×462×200	1310×462×200
Net weight	Main body	kg	25	25	25	25	31

# DC INVERTER MULTI VRF INDOOR UNIT TECHNICAL SALES GUIDE

Model		GMV-ND80PLS/C-T	GMV-ND90PLS/C-T	GMV-ND100PLS/C-T	GMV-ND112PLS/C-T	GMV-ND125PLS/C-T	GMV-ND140PLS/C-T
Cooling capacity	kW	8.0	9.0	10.0	11.2	12.5	14.0
Heating capacity	kW	9.0	10.0	11.2	12.5	14.0	16.0
Air volume	m <sup>3</sup> /h	1250	1500	1500	1700	2000	2000
Unit external static pressure	Pa	50/0~80	50/0~80	50/0~80	50/0~80	50/0~80	50/0~80
Cooling power input	W	110	130	130	130	170	170
Cooling current input	A	0.53	0.63	0.63	0.63	0.8	0.8
Heating power input	W	110	130	130	130	170	170
Heating current input	A	0.53	0.63	0.63	0.63	0.8	0.8
Minimum line current	A	0.5	1.0	1.0	1.0	1.0	1.0
Maximum fuse current	A	0.8	1.9	1.9	1.9	1.9	1.9
Sound pressure level	dB(A)	37	40	40	40	42	42
Power supply		220-240V ~50Hz & 208-230V ~60Hz					
Piping connection	Liquid pipe	mm	Φ9.52	Φ9.52	Φ9.52	Φ9.52	Φ9.52
	Gas pipe	mm	Φ15.9	Φ15.9	Φ15.9	Φ15.9	Φ15.9
Drain pipe	External diameter × thickness	mm	Φ25×2.5	Φ25×2.5	Φ25×2.5	Φ25×2.5	Φ25×2.5
Dimensions	W×D×H	mm	1200×655×260	1340×655×260	1340×655×260	1340×655×260	1340×655×260
Net weight	kg	39	45.5	45.5	45.5	46.5	46.5

Model		GMV-ND18PLS/C1-T	GMV-ND22PLS/C1-T	GMV-ND25PLS/C1-T	GMV-ND28PLS/C1-T	GMV-ND32PLS/C1-T	GMV-ND36PLS/C1-T
Cooling capacity	kW	1.8	2.2	2.5	2.8	3.2	3.6
Heating capacity	kW	2.2	2.5	2.8	3.2	3.6	4.0
Air volume	m <sup>3</sup> /h	450	450	450	450	550	550
Unit external static pressure	Pa	15/0~30	15/0~30	15/0~30	15/0~30	15/0~30	15/0~30
Cooling power input	W	28	28	28	28	37	37
Cooling current input	A	0.2	0.2	0.2	0.2	0.3	0.3
Heating power input	W	25	25	25	25	30	30
Heating current input	A	0.2	0.2	0.2	0.2	0.3	0.3
*Minimum line current	A	0.4	0.4	0.4	0.4	0.4	0.4
*Maximum fuse current	A	6	6	6	6	6	6
Sound pressure level	dB(A)	30	30	30	30	31	31
Power supply		220-240V ~50Hz & 208-230V ~60Hz					
Piping interface	Liquid pipe	mm	Φ6.35	Φ6.35	Φ6.35	Φ6.35	Φ6.35
	Gas pipe	mm	Φ9.52	Φ9.52	Φ9.52	Φ9.52	Φ12.7
Drain pipe	External diameter × thickness	mm	Φ25×2.5	Φ25×2.5	Φ25×2.5	Φ25×2.5	Φ25×2.5
Dimensions	W×D×H	mm	710×462×200	710×462×200	710×462×200	710×462×200	710×462×200
Net weight	Main body	kg	18.5	18.5	18.5	18.5	19

Model		GMV-ND40PLS/C1-T	GMV-ND45PLS/C1-T	GMV-ND50PLS/C1-T	GMV-ND56PLS/C1-T	GMV-ND63PLS/C1-T	GMV-ND71PLS/C1-T	GMV-ND80PLS/C1-T
Cooling capacity	kW	4.0	4.5	5.0	5.6	6.3	7.1	8.0
Heating capacity	kW	4.5	5.0	5.6	6.3	7.1	8.0	9.0
Unit external static pressure	Pa	15/0~30	15/0~30	15/0~30	15/0~30	15/0~30	15/0~30	15/0~30
Air volume	m <sup>3</sup> /h	750	750	750	850	850	1100	1200

Model		GMV-ND40PLS/C1-T	GMV-ND45PLS/C1-T	GMV-ND50PLS/C1-T	GMV-ND56PLS/C1-T	GMV-ND63PLS/C1-T	GMV-ND71PLS/C1-T	GMV-ND80PLS/C1-T
Cooling power input	W	40	40	40	55	55	55	55
Cooling current input	A	0.3	0.3	0.3	0.4	0.4	0.5	0.5
Heating power input	W	35	35	35	45	45	50	50
Heating current input	A	0.3	0.3	0.3	0.4	0.4	0.5	0.5
*Minimum line current	A	0.4	0.4	0.4	0.6	0.6	0.8	0.8
*Maximum fuse current	A	6	6	6	6	6	6	6
Sound pressure level	dB(A)	33	33	33	35	35	37	40
Power supply		220-240V ~50Hz & 208-230V ~60Hz						
Piping interface	Liquid pipe	mm	Φ6.35	Φ6.35	Φ6.35	Φ9.52	Φ9.52	Φ9.52
	Gas pipe	mm	Φ12.7	Φ12.7	Φ12.7	Φ15.9	Φ15.9	Φ15.9
Drain pipe	External diameter × thickness	mm	Φ25×2.5	Φ25×2.5	Φ25×2.5	Φ25×2.5	Φ25×2.5	Φ25×2.5
Dimensions	W×D×H	mm	1010×462×200	1010×462×200	1010×462×200	1010×462×200	1010×462×200	1310×462×200
Net weight	Main body	kg	24	24	24	25	25	31

Notes:

- ① Rated Cooling capacity test conditions: indoor 27°C DB/19°C WB, outdoor 35°C DB; connection pipe length: 5 m, without height drop between units
- ② Rated heating capacity test conditions: indoor 20°C DB, outdoor 7°C DB/6 °C WB; connection pipe length: 5 m, without height drop between units
- ③ In the column of “Unit external static pressure”: The figure before “/” indicates the default external static pressure of unit before delivery, and the figures after indicate the adjustable static pressure range of unit.

## 2.2 Four-way Cassette Type

Model		GMV-ND28T/A-T	GMV-ND36T/A-T	GMV-ND45T/A-T	GMV-ND50T/A-T
Cooling capacity	kW	2.8	3.6	4.5	5.0
Heating capacity	kW	3.2	4.0	5.0	5.6
Air volume	m <sup>3</sup> /h	750	750	750	830
Cooling power input	W	48	48	48	50
Cooling current input	A	0.2	0.2	0.2	0.2
Heating power input	W	48	48	48	50
Heating current input	A	0.2	0.2	0.2	0.2
Minimum line current	A	0.25	0.25	0.25	0.25
Maximum fuse current	A	6	6	6	6
Sound pressure level	dB(A)	36	36	36	36
Power supply		220-240V ~50Hz & 208-230V ~60Hz			
Piping connection	Liquid pipe	mm	Φ6.35	Φ6.35	Φ6.35
	Gas pipe	mm	Φ9.52	Φ12.7	Φ12.7
Drain pipe	External diameter × thickness	mm	Φ25×2.5	Φ25×2.5	Φ25×2.5
Main body Dimensions	W×D×H	mm	840×840×190	840×840×190	840×840×190
Panel Dimensions	W×D×H	mm	950×950×65	950×950×65	950×950×65
Net weight	Main body	mm	22.5	22.5	22.5
	Panel	mm	7	7	7

# DC INVERTER MULTI VRF INDOOR UNIT TECHNICAL SALES GUIDE

Model			GMV-ND56T/A-T	GMV-ND63T/A-T	GMV-ND71T/A-T
Cooling capacity	kW		5.6	6.3	7.1
Heating capacity	kW		6.3	7.1	8.0
Air volume	m <sup>3</sup> /h		1000	1000	1180
Cooling power input	W		59	59	68
Cooling current input	A		0.3	0.3	0.3
Heating power input	W		59	59	68
Heating current input	A		0.3	0.3	0.3
Minimum line current	A		0.38	0.38	0.38
Maximum fuse current	A		6	6	6
Sound pressure level	dB(A)		37	37	38
Power supply			220-240V ~50Hz & 208-230V ~60Hz		
Piping connection	Liquid pipe	mm	Φ9.52	Φ9.52	Φ9.52
	Gas pipe	mm	Φ15.9	Φ15.9	Φ15.9
Drain pipe	External diameter × thickness	mm	Φ25×2.5	Φ25×2.5	Φ25×2.5
Main body dimensions	W×D×H	mm	840×840×240	840×840×240	840×840×240
Panel dimensions	W×D×H	mm	950×950×65	950×950×65	950×950×65
Net weight	Main body	kg	26.5	26.5	26.5
	Panel	kg	7	7	7

Model			GMV-ND80T/A-T	GMV-ND90T/A-T	GMV-ND100T/A-T	GMV-ND112T/A-T
Cooling capacity	kW		8.0	9.0	10.0	11.2
Heating capacity	kW		9.0	10.0	11.2	12.5
Air volume	m <sup>3</sup> /h		1180	1500	1500	1700
Cooling power input	W		68	98	98	110
Cooling current input	A		0.3	0.4	0.4	0.5
Heating power input	W		68	98	98	110
Heating current input	A		0.3	0.4	0.4	0.5
Minimum line current	A		0.38	0.5	0.5	0.63
Maximum fuse current	A		6	6	6	6
Sound pressure level	dB(A)		38	40	40	41
Power supply			220-240V ~50Hz & 208-230V ~60Hz			
Piping connection	Liquid pipe	mm	Φ9.52	Φ9.52	Φ9.52	Φ9.52
	Gas pipe	mm	Φ15.9	Φ15.9	Φ15.9	Φ15.9
Drain pipe	External diameter × thickness	mm	Φ25×2.5	Φ25×2.5	Φ25×2.5	Φ25×2.5
Main body dimensions	W×D×H	mm	840×840×240	840×840×320	840×840×320	840×840×320
Panel dimensions	W×D×H	mm	950×950×65	950×950×65	950×950×65	950×950×65
Net weight	Main body	kg	26.5	32.5	32.5	32.5
	Panel	kg	7	7	7	7

Model			GMV-ND125T/A-T	GMV-ND140T/A-T	GMV-ND160T/A-T
Cooling capacity	kW		12.5	14.0	16.0
Heating capacity	kW		14.0	16.0	17.5
Air volume	m <sup>3</sup> /h		1860	1860	2100
Cooling power input	W		110	110	120
Cooling current input	A		0.5	0.5	0.6
Heating power input	W		110	110	120
Heating current input	A		0.5	0.5	0.6
Minimum line current	A		0.63	0.63	0.75
Maximum fuse current	A		6	6	6
Sound pressure level	dB(A)		43	43	47
Power supply			220-240V ~50Hz & 208-230V ~60Hz		
Piping connection	Liquid pipe	mm	Φ9.52	Φ9.52	Φ9.52
	Gas pipe	mm	Φ15.9	Φ15.9	Φ19.05
Drain pipe	External diameter × thickness	mm	Φ25×2.5	Φ25×2.5	Φ25×2.5
Main body dimensions	W×D×H	mm	840×840×320	840×840×320	910×910×293
Panel dimensions	W×D×H	mm	950×950×65	950×950×65	1040×1040×65
Net weight	Main body	kg	32.5	32.5	46.5
	Panel	kg	7	7	7.5

Notes:

- ① Rated cooling capacity test conditions: indoor 27°C DB/19°C WB, outdoor 35°C DB; connection pipe length: 5 m, without height drop between units.
- ② Rated heating capacity test conditions: indoor 20°C DB, outdoor 7°C DB/6°C WB; connection pipe length: 5 m, without height drop between units.

### 2.3 One-way Cassette Type

Model			GMV-ND22TD/A-T	GMV-ND28TD/A-T	GMV-ND36TD/A-T	GMV-ND45TD/A-T	GMV-ND50TD/A-T	GMV-ND56TD/A-T
Cooling capacity	kW		2.2	2.8	3.6	4.5	5.0	5.6
Heating capacity	kW		2.5	3.2	4.0	5.0	5.6	6.3
Air volume	m <sup>3</sup> /h		600	600	600	830	830	890
Cooling power input	W		30	30	30	45	45	45
Cooling current input	A		0.2	0.2	0.2	0.3	0.3	0.3
Heating power input	W		30	30	30	45	45	45
Heating current input	A		0.2	0.2	0.2	0.3	0.3	0.3
Minimum line current	A		0.25	0.25	0.25	0.38	0.38	0.38
Maximum fuse current	A		6	6	6	6	6	6
Sound pressure level	dB(A)		36	36	36	40	40	41
Power supply			220-240V ~50Hz & 208-230V ~60Hz					
Piping connection	Liquid pipe	mm	Φ6.35	Φ6.35	Φ6.35	Φ6.35	Φ6.35	Φ9.52
	Gas pipe	mm	Φ9.52	Φ9.52	Φ12.7	Φ12.7	Φ12.7	Φ15.9
Drain pipe	External diameter × thickness	mm	Φ25×2.5	Φ25×2.5	Φ25×2.5	Φ25×2.5	Φ25×2.5	Φ25×2.5

# DC INVERTER MULTI VRF INDOOR UNIT TECHNICAL SALES GUIDE

Model			GMV-ND22TD/A-T	GMV-ND28TD/A-T	GMV-ND36TD/A-T	GMV-ND45TD/A-T	GMV-ND50TD/A-T	GMV-ND56TD/A-T
Main body dimensions	W×D×H	mm	987×385×178	987×385×178	987×385×178	987×385×178	987×385×178	987×385×178
Panel dimensions	W×D×H	mm	1200×460×55	1200×460×55	1200×460×55	1200×460×55	1200×460×55	1200×460×55
Net weight	Main body	kg	20	20	20	21	21	21
	Panel	kg	4.2	4.2	4.2	4.2	4.2	4.2

Model			GMV-ND63TD/B-T	GMV-N71TD/B-T	GMV-ND80TD/B-T
Cooling capacity	kW		6.3	7.1	8.0
Heating capacity	kW		7.1	8.0	9.0
Air volume	m³/h		880	1000	1000
Cooling power input	W		57	83	83
Cooling current input	A		0.55	0.86	0.86
Heating power input	W		57	83	83
Heating current input	A		0.55	0.86	0.86
Minimum line current	A		0.55	0.86	0.86
Maximum fuse current	A		6	6	6
Sound pressure level	dB(A)		42	44	44
Power supply			220-240V ~50Hz & 208-230V ~60Hz		
Piping connection	Liquid pipe	mm	Φ9.52	Φ9.52	Φ9.52
	Gas pipe	mm	Φ15.9	Φ15.9	Φ15.9
Drain pipe	External diameter × thickness	mm	Φ25×2.5	Φ25×2.5	Φ25×2.5
Main body dimensions	W×D×H	mm	1200×470×200	1200×470×200	1200×470×200
Panel dimensions	W×D×H	mm	1350×555×64	1350×555×64	1350×555×64
Net weight	Main body	kg	26	26	26
	Panel	kg	7.8	7.8	7.8

Notes:

- ① Rated cooling capacity test conditions: indoor 27°C DB/19°C WB, outdoor 35°C DB; connection pipe length: 5 m, without height drop between units.
- ② Rated heating capacity test conditions: indoor 20°C DB, outdoor 7°C DB/6°C WB; connection pipe length: 5 m, without height drop between units.

## 2.4 Floor Ceiling Type

Model			GMV-ND28ZD/A-T	GMV-ND36ZD/A-T	GMV-ND50ZD/A-T	GMV-ND56ZD/A-T	GMV-ND63ZD/A-T	GMV-ND71ZD/A-T
Cooling capacity	kW		2.8	3.6	5.0	5.6	6.3	7.1
Heating capacity	kW		3.2	4.0	5.6	6.3	7.1	8.0
Air volume	m³/h		650	650	950	950	1400	1400
Cooling power input	W		40	40	50	50	75	75
Cooling current input	A		0.3	0.3	0.4	0.4	0.6	0.6
Heating power input	W		40	40	50	50	75	75
Heating current input	A		0.3	0.3	0.4	0.4	0.6	0.6
Minimum line current	A		0.32	0.32	0.43	0.43	0.64	0.64
Maximum fuse current	A		6	6	6	6	6	6
Sound pressure level	dB(A)		36	36	42	42	44	44
Power supply			220-240V ~50Hz & 208-230V ~60Hz					
Piping connection	Liquid pipe	mm	Φ6.35	Φ6.35	Φ6.35	Φ9.52	Φ9.52	Φ9.52
	Gas pipe	mm	Φ9.52	Φ12.7	Φ12.7	Φ15.9	Φ15.9	Φ15.9



Model			GMV-ND28ZD/A-T	GMV-ND36ZD/A-T	GMV-ND50ZD/A-T	GMV-ND56ZD/A-T	GMV-ND63ZD/A-T	GMV-ND71ZD/A-T
Drain pipe	External diameter × thickness	mm	Φ17×1.75	Φ17×1.75	Φ17×1.75	Φ17×1.75	Φ17×1.75	Φ17×1.75
Outline Dimensions	W×D×H	mm	1220×700×225	1220×700×225	1220×700×225	1220×700×225	1420×700×245	1420×700×245
Net weight		kg	40	40	40	40	50	50

Model			GMV-ND90ZD/A-T	GMV-ND112ZD/A-T	GMV-ND125ZD/A-T	GMV-ND140ZD/A-T	GMV-ND160ZD/A-T
Cooling capacity	kW		9.0	11.2	12.5	14.0	16.0
Heating capacity	kW		10.0	12.5	14.0	16.0	18.0
Air volume	m <sup>3</sup> /h		1600	2000	2000	2000	2300
Cooling power input	W		140	160	160	160	200
Cooling current input	A		1.1	1.4	1.4	1.4	1.9
Heating power input	W		140	160	160	160	200
Heating current input	A		1.1	1.4	1.4	1.4	1.9
Minimum line current	A		1.17	1.5	1.5	1.5	2
Maximum fuse current	A		6	6	6	6	6
Sound pressure level	dB(A)		50	51	52	52	52
Power supply			220-240V ~50Hz & 208-230V ~60Hz				
Piping connection	Liquid pipe	mm	Φ9.52	Φ9.52	Φ9.52	Φ9.52	Φ9.52
	Gas pipe	mm	Φ15.9	Φ15.9	Φ15.9	Φ15.9	Φ19.05
Drain pipe	External diameter × thickness	mm	Φ17×1.5	Φ17×1.5	Φ17×1.5	Φ17×1.5	Φ17×1.75
Outline Dimensions	W×D×H	mm	1420×700×245	1700×700×245	1700×700×245	1700×700×245	1700×700×245
Net weight		kg	50	60	60	60	60

Model			GMV-ND28ZD/B-T	GMV-ND36ZD/B-T	GMV-ND50ZD/B-T	GMV-ND56ZD/B-T	GMV-ND63ZD/B-T	GMV-ND71ZD/B-T
Cooling capacity	kW		2.8	3.6	5.0	5.6	6.3	7.1
Heating capacity	kW		3.2	4.0	5.6	6.3	7.1	8.0
Air volume	m <sup>3</sup> /h		600	600	750	750	1350	1350
Cooling power input	W		35	35	55	55	80	80
Cooling current input	A		0.2	0.2	0.3	0.3	0.4	0.4
Heating power input	W		35	35	55	55	80	80
Heating current input	A		0.2	0.2	0.3	0.3	0.4	0.4
Minimum line current	A		0.2	0.2	0.3	0.3	0.4	0.4
Maximum fuse current	A		6	6	6	6	6	6
Sound pressure level	dB(A)		36	36	42	42	44	44
Power supply			220-240V ~50Hz & 208-230V ~60Hz					
Piping connection	Liquid pipe	mm	Φ6.35	Φ6.35	Φ6.35	Φ9.52	Φ9.52	Φ9.52
	Gas pipe	mm	Φ9.52	Φ12.7	Φ12.7	Φ15.9	Φ15.9	Φ15.9
Drain pipe	External diameter × thickness	mm	Φ17×1.75	Φ17×1.75	Φ17×1.75	Φ17×1.75	Φ17×1.75	Φ17×1.75
Outline Dimensions	W×D×H	mm	870×665×235	870×665×235	870×665×235	870×665×235	1200×665×235	1200×665×235
Net weight		kg	24	24	25	25	32	32



# DC INVERTER MULTI VRF INDOOR UNIT TECHNICAL SALES GUIDE

Model		GMV-ND90ZD/B-T	GMV-ND112ZD/B-T	GMV-ND125ZD/B-T	GMV-ND140ZD/B-T	GMV-ND160ZD/B-T
Cooling capacity	kW	9.0	11.2	12.5	14.0	16.0
Heating capacity	kW	10.0	12.5	14.0	16.0	18.0
Air volume	m <sup>3</sup> /h	1550	1800	1800	2000	2150
Cooling power input	W	120	120	120	150	175
Cooling current input	A	0.7	0.7	0.7	0.8	0.9
Heating power input	W	120	120	120	150	175
Heating current input	A	0.7	0.7	0.7	0.8	0.9
Minimum line current	A	0.7	0.7	0.7	0.8	0.9
Maximum fuse current	A	6	6	6	6	6
Sound pressure level	dB(A)	47	47	47	49	52
Power supply		220-240V ~50Hz & 208-230V ~60Hz				
Piping connection	Liquid pipe	mm	Φ9.52	Φ9.52	Φ9.52	Φ9.52
	Gas pipe	mm	Φ15.9	Φ15.9	Φ15.9	Φ19.05
Drain pipe	External diameter × thickness	mm	Φ17×1.75	Φ17×1.75	Φ17×1.75	Φ17×1.75
Dimensions	W×D×H	mm	1200×665×235	1570×665×235	1570×665×235	1570×665×235
Net weight		kg	33	41	41	43

## Notes:

- ① Rated cooling capacity test conditions: indoor 27°C DB/19°C WB, outdoor 35°C DB; connection pipe length: 5 m, without height drop between units.
- ② Rated heating capacity test conditions: indoor 20°C DB, outdoor 7°C DB/6°C WB; connection pipe length: 5 m, without height drop between units.

## 2.5 Slim Duct Type

Model		GMV-ND22PL/B-T	GMV-ND25PL/B-T	GMV-ND28PL/B-T	GMV-ND32PL/B-T	GMV-ND36PL/B-T	GMV-ND40PL/B-T
Cooling capacity	kW	2.2	2.5	2.8	3.2	3.6	4.0
Heating capacity	kW	2.5	2.8	3.2	3.6	4.0	4.5
Air volume	m <sup>3</sup> /h	450	450	450	550	550	750
Unit external static pressure	Pa	0/0~15	0/0~15	0/0~15	0/0~15	0/0~15	0/0~15
Cooling power input	W	25	25	25	30	30	35
Cooling current input	A	0.2	0.2	0.2	0.3	0.3	0.3
Heating power input	W	25	25	25	30	30	35
Heating current input	A	0.2	0.2	0.2	0.3	0.3	0.3
*Minimum line current	A	0.25	0.25	0.25	0.38	0.38	0.38
*Maximum fuse current	A	6	6	6	6	6	6
Sound pressure level	dB(A)	30	30	30	31	31	33
Power supply		220-240V ~50Hz & 208-230V ~60Hz					
Piping connection	Liquid pipe	mm	Φ6.35	Φ6.35	Φ6.35	Φ6.35	Φ6.35
	Gas pipe	mm	Φ9.52	Φ9.52	Φ9.52	Φ12.7	Φ12.7
Drain pipe	External diameter × thickness	mm	Φ25×2.5	Φ25×2.5	Φ25×2.5	Φ25×2.5	Φ25×2.5
Dimensions	W×D×H	mm	710×450×200	710×450×200	710×450×200	710×450×200	1010×450×200
Net weight	Main body	kg	18.5	18.5	18.5	19.5	19.5

Model		GMV-ND45PL/ B-T	GMV-ND50PL/ B-T	GMV-ND56PL/ B-T	GMV-ND63PL/ B-T	GMV-ND72PL/ B-T	
Cooling capacity	kW	4.5	5.0	5.6	6.3	7.2	
Heating capacity	kW	5.0	5.6	6.3	7.0	8.0	
Air volume	m <sup>3</sup> /h	750	750	850	850	1100	
Unit external static pressure	Pa	0/0~15	0/0~15	0/0~15	0/0~15	0/0~15	
Cooling power input	W	35	35	45	45	50	
Cooling current input	A	0.3	0.3	0.3	0.3	0.5	
Heating power input	W	35	35	45	45	50	
Heating current input	A	0.3	0.3	0.3	0.3	0.5	
*Minimum line current	A	0.38	0.38	0.38	0.38	0.63	
*Maximum fuse current	A	6	6	6	6	6	
Sound pressure level	dB(A)	33	33	35	35	37	
Power supply		220-240V ~50Hz & 208-230V ~60Hz					
Piping connection	Liquid pipe	mm	Φ6.35	Φ6.35	Φ9.52	Φ9.52	Φ9.52
	Gas pipe	mm	Φ12.7	Φ12.7	Φ15.9	Φ15.9	Φ15.9
Drain pipe	External diameter × thickness	mm	Φ25×2.5	Φ25×2.5	Φ25×2.5	Φ25×2.5	Φ25×2.5
Dimensions	W×D×H	mm	1010×450×200	1010×450×200	1010×450×200	1010×450×200	1310×450×200
Net weight	Main body	kg	23.5	23.5	24.5	24.5	30.5

Model		GMV-ND 22PLS/B1-T	GMV-ND 25PLS/B1-T	GMV-ND 28PLS/B1-T	GMV-ND 32PLS/B1-T	GMV-ND 36PLS/B1-T	GMV-ND 40PLS/B1-T
Cooling capacity	kW	2.2	2.5	2.8	3.2	3.6	4.0
Heating capacity	kW	2.5	2.8	3.2	3.6	4.0	4.5
Air volume	m <sup>3</sup> /h	610	610	610	620	650	810
Unit external static pressure	Pa	10/30	10/30	10/30	10/30	10/30	10/30
Cooling power input	W	65	65	65	65	65	65
Cooling current input	A	0.3	0.3	0.3	0.3	0.3	0.3
Heating power input	W	65	65	65	65	65	65
Heating current input	A	0.3	0.3	0.3	0.3	0.3	0.3
*Minimum line current	A	0.63	0.63	0.63	0.63	0.63	0.63
*Maximum fuse current	A	1.1	1.1	1.1	1.1	1.1	1.1
Sound pressure level	dB(A)	38	38	38	38	38	38
Power supply		220-240V ~50Hz & 208-230V ~60Hz					
Piping connection	Liquid pipe	mm	Φ6.35	Φ6.35	Φ6.35	Φ6.35	Φ6.35
	Gas pipe	mm	Φ9.52	Φ9.52	Φ9.52	Φ12.7	Φ12.7
Drain pipe	External diameter × thickness	mm	Φ25×2.5	Φ25×2.5	Φ25×2.5	Φ25×2.5	Φ25×2.5
Dimensions	W×D×H	mm	710×450 ×200	710×450 ×200	710×450 ×200	710×450 ×200	1010×450 ×200
Net weight	Main body	kg	19.0	19.0	19.0	20.0	24.0

Model		GMV-ND45PLS/ B1-T	GMV-ND50PLS/ B1-T	GMV-ND56PLS/ B1-T	GMV-ND63PLS/ B1-T	GMV-ND71PLS/ B1-T
Cooling capacity	kW	4.5	5.0	5.6	6.3	7.1
Heating capacity	kW	5.0	5.6	6.3	7.0	8.0

# DC INVERTER MULTI VRF INDOOR UNIT TECHNICAL SALES GUIDE

Model			GMV-ND45PLS/ B1-T	GMV-ND50PLS/ B1-T	GMV-ND56PLS/ B1-T	GMV-ND63PLS/ B1-T	GMV-ND71PLS/ B1-T
Air volume	m <sup>3</sup> /h		810	810	810	810	1210
Unit external static pressure	Pa		10/30	10/30	10/30	10/30	10/30
Cooling power input	W		65	65	65	65	70
Cooling current input	A		0.3	0.3	0.3	0.3	0.32
Heating power input	W		65	65	65	65	70
Heating current input	A		0.3	0.3	0.3	0.3	0.32
*Minimum line current	A		0.63	0.63	0.63	0.63	0.63
*Maximum fuse current	A		1.1	1.1	1.1	1.1	1.1
Sound pressure level	dB(A)		37	37	37	37	39
Power supply			220-240V ~50Hz & 208-230V ~60Hz				
Piping connection	Liquid pipe	mm	Φ6.35	Φ6.35	Φ9.52	Φ9.52	Φ9.52
	Gas pipe	mm	Φ12.7	Φ12.7	Φ15.9	Φ15.9	Φ15.9
Drain pipe	External diameter × thickness	mm	Φ25×2.5	Φ25×2.5	Φ25×2.5	Φ25×2.5	Φ25×2.5
Dimensions	W×D×H	mm	1010×450×200	1010×450×200	1010×450×200	1010×450×200	1310×450×200
Net weight	Main body	kg	24.0	25.0	25.0	25.0	30.5

## Notes:

- ① Rated Cooling capacity test conditions: indoor 27°C DB/19°C WB, outdoor 35°C DB; connection pipe length: 5 m, without height drop between units
- ② Rated heating capacity test conditions: indoor 20°C DB, outdoor 7°C DB/6°C WB; connection pipe length: 5 m, without height drop between units
- ③ In the column of "Unit external static pressure": The figure before "/" indicates the default external static pressure of unit before delivery, and the figures after indicate the adjustable static pressure range of unit.

## 2.6 Wall Mounted Type

Model			GMV-N22G/A3A-K	GMV-N28G/A3A-K	GMV-N36G/A3A-K	GMV-N45G/A3A-K
Cooling capacity	kW		2.2	2.8	3.6	4.5
Heating capacity	kW		2.5	3.2	4.0	5.0
Air volume	m <sup>3</sup> /h		500	500	630	630
Cooling power input	W		50	50	60	60
Cooling current input	A		0.2	0.2	0.31	0.31
Heating power input	W		50	50	60	60
Heating current input	A		0.2	0.2	0.31	0.31
*Minimum line current	A		0.25	0.25	0.38	0.38
*Maximum fuse current	A		6	6	6	6
Sound pressure level	dB(A)		38	38	44	44
Power supply			220-240V 1phase ~50Hz			
Piping connection	Liquid pipe	mm	Φ6.35	Φ6.35	Φ6.35	Φ6.35
	Gas pipe	mm	Φ9.52	Φ9.52	Φ12.7	Φ12.7
Drain pipe	External diameter × thickness	mm	Φ20×1.5	Φ20×1.5	Φ20×1.5	Φ20×1.5
Dimensions	W×D×H	mm	843×180×275	843×180×275	940×200×298	940×200×298
Net weight	Main body	kg	10.0	10.0	12.5	12.5

Notes:

- ① Rated cooling capacity test conditions: indoor 27°C DB/19°C WB, outdoor 35°C DB; connection pipe length: 5 m, without height drop between units.
- ② Rated heating capacity test conditions: indoor 20°C DB, outdoor 7°C DB/6°C WB; connection pipe length: 5 m, without height drop between units.

Model		GMV-N50G/A3A-K	GMV-N56G/A3A-K	GMV-N63G/A3A-K	GMV-N71G/A3A-K	
Cooling capacity	kW	5.0	5.6	6.3	7.1	
Heating capacity	kW	5.8	6.3	7.0	7.5	
Air volume	m <sup>3</sup> /h	630	750	750	750	
Cooling power input	W	60	70	70	70	
Cooling current input	A	0.31	0.31	0.31	0.31	
Heating power input	W	60	70	70	70	
Heating current input	A	0.31	0.31	0.31	0.31	
*Minimum line current	A	0.38	0.5	0.5	0.5	
*Maximum fuse current	A	6	6	6	6	
Sound pressure level	dB(A)	44	44	44	44	
Power supply		220-240V 1phase~50Hz				
Piping connection	Liquid pipe	mm	Φ6.35	Φ9.52	Φ9.52	Φ9.52
	Gas pipe	mm	Φ12.7	Φ15.9	Φ15.9	Φ15.9
Drain pipe	External diameter × thickness	mm	Φ20×1.5	Φ20×1.5	Φ20×1.5	Φ20×1.5
Dimensions	W×D×H	mm	940×200×298	1008×221×319	1008×221×319	1008×221×319
Net weight	Main body	kg	12.5	15.0	15.0	15.0

Notes:

- ① Rated cooling capacity test conditions: indoor 27°C DB/19°C WB, outdoor 35°C DB; connection pipe length: 5 m, without height drop between units.
- ② Rated heating capacity test conditions: indoor 20°C DB, outdoor 7°C DB/6°C WB; connection pipe length: 5 m, without height drop between units.

Model		GMV-N22G/B3A-K	GMV-N28G/B3A-K	GMV-N36G/B3A-K	GMV-N45G/B3A-K	
Cooling capacity	kW	2.2	2.8	3.6	4.5	
Heating capacity	kW	2.5	3.2	4.0	5.0	
Air volume	m <sup>3</sup> /h	500	500	630	630	
Cooling power input	W	50	50	60	60	
Cooling current input	A	0.2	0.2	0.31	0.31	
Heating power input	W	50	50	60	60	
Heating current input	A	0.2	0.2	0.31	0.31	
*Minimum line current	A	0.25	0.25	0.38	0.38	
*Maximum fuse current	A	6	6	6	6	
Sound pressure level	dB(A)	38	38	44	44	
Power supply		220-240V 1phase ~50Hz				
Piping connection	Liquid pipe	mm	Φ6.35	Φ6.35	Φ6.35	Φ6.35
	Gas pipe	mm	Φ9.52	Φ9.52	Φ12.7	Φ12.7
Drain pipe	External diameter × thickness	mm	Φ20×1.5	Φ20×1.5	Φ20×1.5	Φ20×1.5
Dimensions	W×D×H	mm	843×180×275	843×180×275	940×200×298	940×200×298
Net weight	Main body	kg	10.0	10.0	12.5	12.5

# DC INVERTER MULTI VRF INDOOR UNIT TECHNICAL SALES GUIDE

## Notes:

- ① Rated cooling capacity test conditions: indoor 27°C DB/19°C WB, outdoor 35°C DB; connection pipe length: 5 m, without height drop between units.
- ② Rated heating capacity test conditions: indoor 20°C DB, outdoor 7°C DB/6°C WB; connection pipe length: 5 m, without height drop between units.

Model		GMV-N50G/B3A-K	GMV-N56G/B3A-K	GMV-N63G/B3A-K	GMV-N71G/B3A-K	
Cooling capacity	kW	5.0	5.6	6.3	7.1	
Heating capacity	kW	5.8	6.3	7.0	7.5	
Air volume	m <sup>3</sup> /h	630	750	750	750	
Cooling power input	W	60	70	70	70	
Cooling current input	A	0.31	0.31	0.31	0.31	
Heating power input	W	60	70	70	70	
Heating current input	A	0.31	0.31	0.31	0.31	
*Minimum line current	A	0.38	0.5	0.5	0.5	
*Maximum fuse current	A	6	6	6	6	
Sound pressure level	dB(A)	44	44	44	44	
Power supply		220-240V 1phase~50Hz				
Piping connection	Liquid pipe	mm	Φ6.35	Φ9.52	Φ9.52	Φ9.52
	Gas pipe	mm	Φ12.7	Φ15.9	Φ15.9	Φ15.9
Drain pipe	External diameter × thickness	mm	Φ20×1.5	Φ20×1.5	Φ20×1.5	Φ20×1.5
Outline Dimensions	W×D×H	mm	940×200×298	1008×221×319	1008×221×319	1008×221×319
Net weight	Main body	kg	12.5	15.0	15.0	15.0

Model		GMV-N22G/A2A-K	GMV-N28G/A2A-K	GMV-N36G/A2A-K	GMV-N45G/A2A-K	
Cooling capacity	kW	2.2	2.8	3.6	4.5	
Heating capacity	kW	2.5	3.2	4.0	5.0	
Air volume	m <sup>3</sup> /h	500	500	630	630	
Cooling power input	W	50	50	60	60	
Cooling current input	A	0.2	0.2	0.31	0.31	
Heating power input	W	50	50	60	60	
Heating current input	A	0.2	0.2	0.31	0.31	
*Minimum line current	A	0.25	0.25	0.38	0.38	
*Maximum fuse current	A	6	6	6	6	
Sound pressure level	dB(A)	38	38	44	44	
Power supply		220-240V 1phase ~50Hz				
Piping connection	Liquid pipe	mm	Φ6.35	Φ6.35	Φ6.35	Φ6.35
	Gas pipe	mm	Φ9.52	Φ9.52	Φ12.7	Φ12.7
Drain pipe	External diameter × thickness	mm	Φ20×1.5	Φ20×1.5	Φ20×1.5	Φ20×1.5
Dimensions	W×D×H	mm	843×180×275	843×180×275	940×200×298	940×200×298
Net weight	Main body	kg	10.0	10.0	12.5	12.5

## Notes:

- ① Rated cooling capacity test conditions: indoor 27°C DB/19°C WB, outdoor 35°C DB; connection pipe length: 5 m, without height drop between units.

② Rated heating capacity test conditions: indoor 20°C DB, outdoor 7°C DB/6°C WB; connection pipe length: 5 m, without height drop between units.

Model			GMV-N50G/A2A-K	GMV-N56G/A2A-K	GMV-N63G/A2A-K	GMV-N71G/A2A-K
Cooling capacity	kW		5.0	5.6	6.3	7.1
Heating capacity	kW		5.8	6.3	7.0	7.5
Air volume	m <sup>3</sup> /h		630	750	750	750
Cooling power input	W		60	70	70	70
Cooling current input	A		0.31	0.31	0.31	0.31
Heating power input	W		60	70	70	70
Heating current input	A		0.31	0.31	0.31	0.31
*Minimum line current	A		0.38	0.5	0.5	0.5
*Maximum fuse current	A		6	6	6	6
Sound pressure level	dB(A)		44	44	44	44
Power supply			220-240V 1phase~50Hz			
Piping connection	Liquid pipe	mm	Φ6.35	Φ9.52	Φ9.52	Φ9.52
	Gas pipe	mm	Φ12.7	Φ15.9	Φ15.9	Φ15.9
Drain pipe	External diameter × thickness	mm	Φ20×1.5	Φ20×1.5	Φ20×1.5	Φ20×1.5
Dimensions	W×D×H	mm	940×200×298	1008×221×319	1008×221×319	1008×221×319
Net weight	Main body	kg	12.5	15.0	15.0	15.0

Notes:

- ① Rated cooling capacity test conditions: indoor 27°C DB/19°C WB, outdoor 35°C DB; connection pipe length: 5 m, without height drop between units.  
 ② Rated heating capacity test conditions: indoor 20°C DB, outdoor 7°C DB/6°C WB; connection pipe length: 5 m, without height drop between units.

Model			GMV-N22G/A4A-K	GMV-N28G/A4A-K	GMV-N36G/A4A-K	GMV-N45G/A4A-K
Cooling capacity	kW		2.2	2.8	3.6	4.5
Heating capacity	kW		2.5	3.2	4.0	5.0
Air volume	m <sup>3</sup> /h		500	500	630	630
Cooling power input	W		50	50	60	60
Cooling current input	A		0.2	0.2	0.31	0.31
Heating power input	W		50	50	60	60
Heating current input	A		0.2	0.2	0.31	0.31
*Minimum line current	A		0.25	0.25	0.38	0.38
*Maximum fuse current	A		6	6	6	6
Sound pressure level	dB(A)		38	38	44	44
Power supply			220-240V 1phase ~50Hz			
Piping connection	Liquid pipe	mm	Φ6.35	Φ6.35	Φ6.35	Φ6.35
	Gas pipe	mm	Φ9.52	Φ9.52	Φ12.7	Φ12.7
Drain pipe	External diameter × thickness	mm	Φ20×1.5	Φ20×1.5	Φ20×1.5	Φ20×1.5
Dimensions	W×D×H	mm	843×180×275	843×180×275	940×200×298	940×200×298
Net weight	Main body	kg	10.0	10.0	12.5	12.5

Notes:

- ① Rated cooling capacity test conditions: indoor 27°C DB/19°C WB, outdoor 35°C DB; connection

# DC INVERTER MULTI VRF INDOOR UNIT TECHNICAL SALES GUIDE

pipe length: 5 m, without height drop between units.

- ② Rated heating capacity test conditions: indoor 20°C DB, outdoor 7°C DB/6°C WB; connection pipe length: 5 m, without height drop between units.

Model		GMV-N50G/A4A-K	GMV-N56G/A4A-K	GMV-N63G/A4A-K	GMV-N71G/A4A-K	
Cooling capacity	kW	5.0	5.6	6.3	7.1	
Heating capacity	kW	5.8	6.3	7.0	7.5	
Air volume	m <sup>3</sup> /h	630	750	750	750	
Cooling power input	W	60	70	70	70	
Cooling current input	A	0.31	0.31	0.31	0.31	
Heating power input	W	60	70	70	70	
Heating current input	A	0.31	0.31	0.31	0.31	
*Minimum line current	A	0.38	0.5	0.5	0.5	
*Maximum fuse current	A	6	6	6	6	
Sound pressure level	dB(A)	44	44	44	44	
Power supply		220-240V 1phase~50Hz				
Piping connection	Liquid pipe	mm	Φ6.35	Φ9.52	Φ9.52	Φ9.52
	Gas pipe	mm	Φ12.7	Φ15.9	Φ15.9	Φ15.9
Drain pipe	External diameter × thickness	mm	Φ20×1.5	Φ20×1.5	Φ20×1.5	Φ20×1.5
Dimensions	W×D×H	mm	940×200×298	1008×221×319	1008×221×319	1008×221×319
Net weight	Main body	kg	12.5	15.0	15.0	15.0

Notes:

- ① Rated cooling capacity test conditions: indoor 27°C DB/19°C WB, outdoor 35°C DB; connection pipe length: 5 m, without height drop between units.  
 ② Rated heating capacity test conditions: indoor 20°C DB, outdoor 7°C DB/6°C WB; connection pipe length: 5 m, without height drop between units.

Model		GMV-N22G/A8A-K	GMV-N28G/A8A-K	GMV-N36G/A8A-K	GMV-N45G/A8A-K	
Cooling capacity	kW	2.2	2.8	3.6	4.5	
Heating capacity	kW	2.5	3.2	4.0	5.0	
Air volume	m <sup>3</sup> /h	500	500	630	630	
Cooling power input	W	50	50	60	60	
Cooling current input	A	0.2	0.2	0.31	0.31	
Heating power input	W	50	50	60	60	
Heating current input	A	0.2	0.2	0.31	0.31	
*Minimum line current	A	0.25	0.25	0.38	0.38	
*Maximum fuse current	A	6	6	6	6	
Sound pressure level	dB(A)	38	38	44	44	
Power supply		220-240V 1phase ~50Hz				
Piping connection	Liquid pipe	mm	Φ6.35	Φ6.35	Φ6.35	Φ6.35
	Gas pipe	mm	Φ9.52	Φ9.52	Φ12.7	Φ12.7
Drain pipe	External diameter × thickness	mm	Φ20×1.5	Φ20×1.5	Φ20×1.5	Φ20×1.5
Dimensions	W×D×H	mm	843×180×275	843×180×275	940×200×298	940×200×298
Net weight	Main body	kg	10.0	10.0	12.5	12.5



Notes:

- ① Rated cooling capacity test conditions: indoor 27°C DB/19°C WB, outdoor 35°C DB; connection pipe length: 5m, without height drop between units.
- ② Rated heating capacity test conditions: indoor 20°C DB, outdoor 7°C DB/6°C WB; connection pipe length: 5m, without height drop between units.

Model			GMV-N50G/A8A-K	GMV-N56G/A8A-K	GMV-N63G/A8A-K	GMV-N71G/A8A-K
Cooling capacity	kW		5.0	5.6	6.3	7.1
Heating capacity	kW		5.8	6.3	7.0	7.5
Air volume	m <sup>3</sup> /h		630	750	750	750
Cooling power input	W		60	70	70	70
Cooling current input	A		0.31	0.31	0.31	0.31
Heating power input	W		60	70	70	70
Heating current input	A		0.31	0.31	0.31	0.31
*Minimum line current	A		0.38	0.5	0.5	0.5
*Maximum fuse current	A		6	6	6	6
Sound pressure level	dB(A)		44	44	44	44
Power supply			220-240V 1phase~50Hz			
Piping connection	Liquid pipe	mm	Φ6.35	Φ9.52	Φ9.52	Φ9.52
	Gas pipe	mm	Φ12.7	Φ15.9	Φ15.9	Φ15.9
Drain pipe	External diameter × thickness	mm	Φ20×1.5	Φ20×1.5	Φ20×1.5	Φ20×1.5
Dimensions	W×D×H	mm	940×200×298	1008×221×319	1008×221×319	1008×221×319
Net weight	Main body	kg	12.5	15.0	15.0	15.0

Notes:

- ① Rated cooling capacity test conditions: indoor 27°C DB/19°C WB, outdoor 35°C DB; connection pipe length: 5 m, without height drop between units.
- ② Rated heating capacity test conditions: indoor 20°C DB, outdoor 7°C DB/6°C WB; connection pipe length: 5 m, without height drop between units.

Model			GMV-N22G/C9A-K	GMV-N28G/ C9A-K	GMV-N36G/ C9A-K	GMV-N45G/ C9A-K
Cooling capacity	kW		2.2	2.8	3.6	4.5
Heating capacity	kW		2.5	3.2	4.0	5.0
Air volume	m <sup>3</sup> /h		500	500	630	630
Cooling power input	W		50	50	60	60
Cooling current input	A		0.2	0.2	0.31	0.31
Heating power input	W		50	50	60	60
Heating current input	A		0.2	0.2	0.31	0.31
*Minimum line current	A		0.25	0.25	0.38	0.38
*Maximum fuse current	A		6	6	6	6
Sound pressure level	dB(A)		38	38	44	44
Power supply			220-240V 1phase ~50Hz			
Piping connection	Liquid pipe	mm	Φ6.35	Φ6.35	Φ6.35	Φ6.35
	Gas pipe	mm	Φ9.52	Φ9.52	Φ12.7	Φ12.7
Drain pipe	External diameter × thickness	mm	Φ20×1.5	Φ20×1.5	Φ20×1.5	Φ20×1.5



# DC INVERTER MULTI VRF INDOOR UNIT TECHNICAL SALES GUIDE

Model			GMV-N22G/C9A-K	GMV-N28G/ C9A-K	GMV-N36G/ C9A-K	GMV-N45G/ C9A-K
Dimensions	W×D×H	mm	843×180×275	843×180×275	940×200×298	940×200×298
Net weight	Main body	kg	10.0	10.0	12.5	12.5

## Notes:

- ① Rated cooling capacity test conditions: indoor 27°C DB/19°C WB, outdoor 35°C DB; connection pipe length: 5 m, without height drop between units.
- ② Rated heating capacity test conditions: indoor 20°C DB, outdoor 7°C DB/6°C WB; connection pipe length: 5 m, without height drop between units.

Model			GMV-N50G/ C9A-K	GMV-N56G/ C9A-K	GMV-N63G/ C9A-K	GMV-N71G/ C9A-K
Cooling capacity	kW		5.0	5.6	6.3	7.1
Heating capacity	kW		5.8	6.3	7.0	7.5
Air volume	m <sup>3</sup> /h		630	750	750	750
Cooling power input	W		60	70	70	70
Cooling current input	A		0.31	0.31	0.31	0.31
Heating power input	W		60	70	70	70
Heating current input	A		0.31	0.31	0.31	0.31
*Minimum line current	A		0.38	0.5	0.5	0.5
*Maximum fuse current	A		6	6	6	6
Sound pressure level	dB(A)		44	44	44	44
Power supply			220-240V 1phase~50Hz			
Piping connection	Liquid pipe	mm	Φ6.35	Φ9.52	Φ9.52	Φ9.52
	Gas pipe	mm	Φ12.7	Φ15.9	Φ15.9	Φ15.9
Drain pipe	External diameter × thickness	mm	Φ20×1.5	Φ20×1.5	Φ20×1.5	Φ20×1.5
Dimensions	W×D×H	mm	940×200×298	1008×221×319	1008×221×319	1008×221×319
Net weight	Main body	kg	12.5	15.0	15.0	15.0

## Notes:

- ① Rated cooling capacity test conditions: indoor 27°C DB/19°C WB, outdoor 35°C DB; connection pipe length: 5 m, without height drop between units.
- ② Rated heating capacity test conditions: indoor 20°C DB, outdoor 7°C DB/6°C WB; connection pipe length: 5 m, without height drop between units.

Model			GMV-N22G/E3A-K	GMV-N28G/ E3A-K	GMV-N36G/ E3A-K	GMV-N45G/ E3A-K
Cooling capacity	kW		2.2	2.8	3.6	4.5
Heating capacity	kW		2.5	3.2	4.0	5.0
Air volume	m <sup>3</sup> /h		500	500	630	630
Cooling power input	W		50	50	60	60
Cooling current input	A		0.2	0.2	0.31	0.31
Heating power input	W		50	50	60	60
Heating current input	A		0.2	0.2	0.31	0.31
*Minimum line current	A		0.25	0.25	0.38	0.38
*Maximum fuse current	A		6	6	6	6
Sound pressure level	dB(A)		38	38	44	44
Power supply			220-240V 1phase ~50Hz			

Model			GMV-N22G/E3A-K	GMV-N28G/ E3A-K	GMV-N36G/ E3A-K	GMV-N45G/ E3A-K
Piping connection	Liquid pipe	mm	Φ6.35	Φ6.35	Φ6.35	Φ6.35
	Gas pipe	mm	Φ9.52	Φ9.52	Φ12.7	Φ12.7
Drain pipe	External diameter × thickness	mm	Φ20×1.5	Φ20×1.5	Φ20×1.5	Φ20×1.5
Dimensions	W×D×H	mm	843×180×275	843×180×275	940×200×298	940×200×298
Net weight	Main body	kg	10.0	10.0	12.5	12.5

Notes:

- ① Rated cooling capacity test conditions: indoor 27°C DB/19°C WB, outdoor 35°C DB; connection pipe length: 5 m, without height drop between units.
- ② Rated heating capacity test conditions: indoor 20°C DB, outdoor 7°C DB/6°C WB; connection pipe length: 5 m, without height drop between units.

Model			GMV-N50G/ E3A-K	GMV-N56G/ E3A-K	GMV-N63G/ E3A-K	GMV-N71G/ E3A-K
Cooling capacity	kW		5.0	5.6	6.3	7.1
Heating capacity	kW		5.8	6.3	7.0	7.5
Air volume	m³/h		630	750	750	750
Cooling power input	W		60	70	70	70
Cooling current input	A		0.31	0.31	0.31	0.31
Heating power input	W		60	70	70	70
Heating current input	A		0.31	0.31	0.31	0.31
*Minimum line current	A		0.38	0.5	0.5	0.5
*Maximum fuse current	A		6	6	6	6
Sound pressure level	dB(A)		44	44	44	44
Power supply			220-240V 1phase~50Hz			
Piping connection	Liquid pipe	mm	Φ6.35	Φ9.52	Φ9.52	Φ9.52
	Gas pipe	mm	Φ12.7	Φ15.9	Φ15.9	Φ15.9
Drain pipe	External diameter × thickness	mm	Φ20×1.5	Φ20×1.5	Φ20×1.5	Φ20×1.5
Dimensions	W×D×H	mm	940×200×298	1008×221×319	1008×221×319	1008×221×319
Net weight	Main body	kg	12.5	15.0	15.0	15.0

Notes:

- ① Rated cooling capacity test conditions: indoor 27°C DB/19°C WB, outdoor 35°C DB; connection pipe length: 5 m, without height drop between units.
- ② Rated heating capacity test conditions: indoor 20°C DB, outdoor 7°C DB/6°C WB; connection pipe length: 5 m, without height drop between units.

Model			GMV-N22G/A3A-D	GMV-N28G/A3A-D	GMV-N36G/A3A-D	GMV-N45G/A3A-D
Cooling capacity	kW		2.2	2.8	3.6	4.5
Heating capacity	kW		2.5	3.2	4.0	5.0
Air volume	m³/h		500	500	630	630
Cooling power input	W		50	50	60	60
Cooling current input	A		0.2	0.2	0.21	0.21
Heating power input	W		50	50	60	60
Heating current input	A		0.2	0.2	0.21	0.21
*Minimum line current	A		0.25	0.25	0.38	0.38

# DC INVERTER MULTI VRF INDOOR UNIT TECHNICAL SALES GUIDE

Model			GMV-N22G/A3A-D	GMV-N28G/A3A-D	GMV-N36G/A3A-D	GMV-N45G/A3A-D
*Maximum fuse current	A		6	6	6	6
Sound pressure level	dB(A)		38	38	44	44
Power supply			208-230V 1phase ~60Hz			
Piping connection	Liquid pipe	mm	Φ6.35	Φ6.35	Φ6.35	Φ6.35
	Gas pipe	mm	Φ9.52	Φ9.52	Φ12.7	Φ12.7
Drain pipe	External diameter × thickness	mm	Φ20×1.5	Φ20×1.5	Φ20×1.5	Φ20×1.5
Dimensions	W×D×H	mm	843×180×275	843×180×275	940×200×298	940×200×298
Net weight	Main body	kg	10.0	10.0	12.5	12.5

## Notes:

- ① Rated cooling capacity test conditions: indoor 27°C DB/19°C WB, outdoor 35°C DB; connection pipe length: 5 m, without height drop between units.
- ② Rated heating capacity test conditions: indoor 20°C DB, outdoor 7°C DB/6°C WB; connection pipe length: 5 m, without height drop between units.

Model			GMV-N50G/A3A-D	GMV-N56G/A3A-D	GMV-N63G/A3A-D	GMV-N71G/A3A-D
Cooling capacity	kW		5.0	5.6	6.3	7.1
Heating capacity	kW		5.8	6.3	7.0	7.5
Air volume	m³/h		630	750	750	750
Cooling power input	W		60	70	70	70
Cooling current input	A		0.21	0.31	0.31	0.31
Heating power input	W		60	70	70	70
Heating current input	A		0.21	0.31	0.31	0.31
*Minimum line current	A		0.38	0.5	0.5	0.5
*Maximum fuse current	A		6	6	6	6
Sound pressure level	dB(A)		44	44	44	44
Power supply			208-230V 1phase ~60Hz			
Piping connection	Liquid pipe	mm	Φ6.35	Φ9.52	Φ9.52	Φ9.52
	Gas pipe	mm	Φ12.7	Φ15.9	Φ15.9	Φ15.9
Drain pipe	External diameter × thickness	mm	Φ20×1.5	Φ20×1.5	Φ20×1.5	Φ20×1.5
Dimensions	W×D×H	mm	940×200×298	1008×221×319	1008×221×319	1008×221×319
Net weight	Main body	kg	12.5	15.0	15.0	15.0

## Notes:

- ① Rated cooling capacity test conditions: indoor 27°C DB/19°C WB, outdoor 35°C DB; connection pipe length: 5 m, without height drop between units.
- ② Rated heating capacity test conditions: indoor 20°C DB, outdoor 7°C DB/6°C WB; connection pipe length: 5 m, without height drop between units.

Model			GMV-N22G/A2A-D	GMV-N28G/A2A-D	GMV-N36G/A2A-D	GMV-N45G/A2A-D
Cooling capacity	kW		2.2	2.8	3.6	4.5
Heating capacity	kW		2.5	3.2	4.0	5.0
Air volume	m³/h		500	500	630	630
Cooling power input	W		50	50	60	60
Cooling current input	A		0.2	0.2	0.21	0.21
Heating power input	W		50	50	60	60

Model			GMV-N22G/A2A-D	GMV-N28G/A2A-D	GMV-N36G/A2A-D	GMV-N45G/A2A-D
Heating current input	A		0.2	0.2	0.21	0.21
*Minimum line current	A		0.25	0.25	0.38	0.38
*Maximum fuse current	A		6	6	6	6
Sound pressure level	dB(A)		38	38	44	44
Power supply			208-230V 1phase ~60Hz			
Piping connection	Liquid pipe	mm	Φ6.35	Φ6.35	Φ6.35	Φ6.35
	Gas pipe	mm	Φ9.52	Φ9.52	Φ12.7	Φ12.7
Drain pipe	External diameter × thickness	mm	Φ20×1.5	Φ20×1.5	Φ20×1.5	Φ20×1.5
Dimensions	W×D×H	mm	843×180×275	843×180×275	940×200×298	940×200×298
Net weight	Main body	kg	10.0	10.0	12.5	12.5

Notes:

- ① Rated cooling capacity test conditions: indoor 27°C DB/19°C WB, outdoor 35°C DB; connection pipe length: 5 m, without height drop between units.
- ② Rated heating capacity test conditions: indoor 20°C DB, outdoor 7°C DB/6°C WB; connection pipe length: 5 m, without height drop between units.

Model			GMV-N50G/A2A-D	GMV-N56G/A2A-D	GMV-N63G/A2A-D	GMV-N71G/A2A-D
Cooling capacity	kW		5.0	5.6	6.3	7.1
Heating capacity	kW		5.8	6.3	7.0	7.5
Air volume	m³/h		630	750	750	750
Cooling power input	W		60	70	70	70
Cooling current input	A		0.21	0.31	0.31	0.31
Heating power input	W		60	70	70	70
Heating current input	A		0.21	0.31	0.31	0.31
*Minimum line current	A		0.38	0.5	0.5	0.5
*Maximum fuse current	A		6	6	6	6
Sound pressure level	dB(A)		44	44	44	44
Power supply			208-230V 1phase ~60Hz			
Piping connection	Liquid pipe	mm	Φ6.35	Φ9.52	Φ9.52	Φ9.52
	Gas pipe	mm	Φ12.7	Φ15.9	Φ15.9	Φ15.9
Drain pipe	External diameter × thickness	mm	Φ20×1.5	Φ20×1.5	Φ20×1.5	Φ20×1.5
Dimensions	W×D×H	mm	940×200×298	1008×221×319	1008×221×319	1008×221×319
Net weight	Main body	kg	12.5	15.0	15.0	15.0

Notes:

- ① Rated cooling capacity test conditions: indoor 27°C DB/19°C WB, outdoor 35°C DB; connection pipe length: 5 m, without height drop between units.
- ② Rated heating capacity test conditions: indoor 20°C DB, outdoor 7°C DB/6°C WB; connection pipe length: 5 m, without height drop between units.

Model			GMV-N22G/A4A-D	GMV-N28G/A4A-D	GMV-N36G/A4A-D	GMV-N45G/A4A-D
Cooling capacity	kW		2.2	2.8	3.6	4.5
Heating capacity	kW		2.5	3.2	4.0	5.0
Air volume	m³/h		500	500	630	630

# DC INVERTER MULTI VRF INDOOR UNIT TECHNICAL SALES GUIDE

Model			GMV-N22G/A4A-D	GMV-N28G/A4A-D	GMV-N36G/A4A-D	GMV-N45G/A4A-D
Cooling power input	W		50	50	60	60
Cooling current input	A		0.2	0.2	0.21	0.21
Heating power input	W		50	50	60	60
Heating current input	A		0.2	0.2	0.21	0.21
*Minimum line current	A		0.25	0.25	0.38	0.38
*Maximum fuse current	A		6	6	6	6
Sound pressure level	dB(A)		38	38	44	44
Power supply			208-230V 1phase ~60Hz			
Piping connection	Liquid pipe	mm	Φ6.35	Φ6.35	Φ6.35	Φ6.35
	Gas pipe	mm	Φ9.52	Φ9.52	Φ12.7	Φ12.7
Drain pipe	External diameter × thickness	mm	Φ20×1.5	Φ20×1.5	Φ20×1.5	Φ20×1.5
Dimensions	W×D×H	mm	843×180×275	843×180×275	940×200×298	940×200×298
Net weight	Main body	kg	10.0	10.0	12.5	12.5

## Notes:

- ① Rated cooling capacity test conditions: indoor 27°C DB/19°C WB, outdoor 35°C DB; connection pipe length: 5 m, without height drop between units.
- ② Rated heating capacity test conditions: indoor 20°C DB, outdoor 7°C DB/6°C WB; connection pipe length: 5 m, without height drop between units.

Model			GMV-N50G/A4A-D	GMV-N56G/A4A-D	GMV-N63G/A4A-D	GMV-N71G/A4A-D
Cooling capacity	kW		5.0	5.6	6.3	7.1
Heating capacity	kW		5.8	6.3	7.0	7.5
Air volume	m³/h		630	750	750	750
Cooling power input	W		60	70	70	70
Cooling current input	A		0.21	0.31	0.31	0.31
Heating power input	W		60	70	70	70
Heating current input	A		0.21	0.31	0.31	0.31
*Minimum line current	A		0.38	0.5	0.5	0.5
*Maximum fuse current	A		6	6	6	6
Sound pressure level	dB(A)		44	44	44	44
Power supply			208-230V 1phase ~60Hz			
Piping connection	Liquid pipe	mm	Φ6.35	Φ9.52	Φ9.52	Φ9.52
	Gas pipe	mm	Φ12.7	Φ15.9	Φ15.9	Φ15.9
Drain pipe	External diameter × thickness	mm	Φ20×1.5	Φ20×1.5	Φ20×1.5	Φ20×1.5
Dimensions	W×D×H	mm	940×200×298	1008×221×319	1008×221×319	1008×221×319
Net weight	Main body	kg	12.5	15.0	15.0	15.0

## Notes:

- ① Rated cooling capacity test conditions: indoor 27°C DB/19°C WB, outdoor 35°C DB; connection pipe length: 5 m, without height drop between units.
- ② Rated heating capacity test conditions: indoor 20°C DB, outdoor 7°C DB/6°C WB; connection pipe length: 5 m, without height drop between units.

Model			GMV-N22G/A8A-D	GMV-N28G/A8A-D	GMV-N36G/A8A-D	GMV-N45G/A8A-D
Cooling capacity	kW		2.2	2.8	3.6	4.5
Heating capacity	kW		2.5	3.2	4.0	5.0
Air volume	m <sup>3</sup> /h		500	500	630	630
Cooling power input	W		50	50	60	60
Cooling current input	A		0.2	0.2	0.21	0.21
Heating power input	W		50	50	60	60
Heating current input	A		0.2	0.2	0.21	0.21
*Minimum line current	A		0.25	0.25	0.38	0.38
*Maximum fuse current	A		6	6	6	6
Sound pressure level	dB(A)		38	38	44	44
Power supply			208-230V 1phase ~60Hz			
Piping connection	Liquid pipe	mm	Φ6.35	Φ6.35	Φ6.35	Φ6.35
	Gas pipe	mm	Φ9.52	Φ9.52	Φ12.7	Φ12.7
Drain pipe	External diameter	mm	Φ20×1.5	Φ20×1.5	Φ20×1.5	Φ20×1.5
Dimensions	W×D×H	mm	843×180×275	843×180×275	940×200×298	940×200×298
Net weight	Main body	kg	10.0	10.0	12.5	12.5

Notes:

- ① Rated cooling capacity test conditions: indoor 27°C DB/19°C WB, outdoor 35°C DB; connection pipe length: 5 m, without height drop between units.
- ② Rated heating capacity test conditions: indoor 20°C DB, outdoor 7°C DB/6°C WB; connection pipe length: 5 m, without height drop between units.

Model			GMV-N50G/A8A-D	GMV-N56G/A8A-D	GMV-N63G/A8A-D	GMV-N71G/A8A-D
Cooling capacity	kW		5.0	5.6	6.3	7.1
Heating capacity	kW		5.8	6.3	7.0	7.5
Air volume	m <sup>3</sup> /h		630	750	750	750
Cooling power input	W		60	70	70	70
Cooling current input	A		0.21	0.31	0.31	0.31
Heating power input	W		60	70	70	70
Heating current input	A		0.21	0.31	0.31	0.31
*Minimum line current	A		0.38	0.5	0.5	0.5
*Maximum fuse current	A		6	6	6	6
Sound pressure level	dB(A)		44	44	44	44
Power supply			208-230V 1phase ~60Hz			
Piping connection	Liquid pipe	mm	Φ6.35	Φ9.52	Φ9.52	Φ9.52
	Gas pipe	mm	Φ12.7	Φ15.9	Φ15.9	Φ15.9
Drain pipe	External diameter × thickness	mm	Φ20×1.5	Φ20×1.5	Φ20×1.5	Φ20×1.5
Dimensions	W×D×H	mm	940×200×298	1008×221×319	1008×221×319	1008×221×319
Net weight	Main body	kg	12.5	15.0	15.0	15.0

Notes:

- ① Rated cooling capacity test conditions: indoor 27°C DB/19°C WB, outdoor 35°C DB; connection pipe length: 5 m, without height drop between units.

# DC INVERTER MULTI VRF INDOOR UNIT TECHNICAL SALES GUIDE

- ② Rated heating capacity test conditions: indoor 20°C DB, outdoor 7°C DB/6°C WB; connection pipe length: 5 m, without height drop between units.

Model			GMV-N22G/C9A-D	GMV-N28G/C9A-D	GMV-N36G/C9A-D	GMV-N45G/C9A-D
Cooling capacity	kW		2.2	2.8	3.6	4.5
Heating capacity	kW		2.5	3.2	4.0	5.0
Air volume	m <sup>3</sup> /h		500	500	630	630
Cooling power input	W		50	50	60	60
Cooling current input	A		0.2	0.2	0.21	0.21
Heating power input	W		50	50	60	60
Heating current input	A		0.2	0.2	0.21	0.21
*Minimum line current	A		0.25	0.25	0.38	0.38
*Maximum fuse current	A		6	6	6	6
Sound pressure level	dB(A)		38	38	44	44
Power supply			208-230V 1phase ~60Hz			
Piping connection	Liquid pipe	mm	Φ6.35	Φ6.35	Φ6.35	Φ6.35
	Gas pipe	mm	Φ9.52	Φ9.52	Φ12.7	Φ12.7
Drain pipe	External diameter × thickness	mm	Φ20×1.5	Φ20×1.5	Φ20×1.5	Φ20×1.5
Dimensions	W×D×H	mm	843×180×275	843×180×275	940×200×298	940×200×298
Net weight	Main body	kg	10.0	10.0	12.5	12.5

Notes:

- ① Rated cooling capacity test conditions: indoor 27°C DB/19°C WB, outdoor 35°C DB; connection pipe length: 5 m, without height drop between units.  
 ② Rated heating capacity test conditions: indoor 20°C DB, outdoor 7°C DB/6°C WB; connection pipe length: 5 m, without height drop between units.

Model			GMV-N50G/C9A-D	GMV-N56G/C9A-D	GMV-N63G/C9A-D	GMV-N71G/C9A-D
Cooling capacity	kW		5.0	5.6	6.3	7.1
Heating capacity	kW		5.8	6.3	7.0	7.5
Air volume	m <sup>3</sup> /h		630	750	750	750
Cooling power input	W		60	70	70	70
Cooling current input	A		0.21	0.31	0.31	0.31
Heating power input	W		60	70	70	70
Heating current input	A		0.21	0.31	0.31	0.31
*Minimum line current	A		0.38	0.5	0.5	0.5
*Maximum fuse current	A		6	6	6	6
Sound pressure level	dB(A)		44	44	44	44
Power supply			208-230V 1phase ~60Hz			
Piping connection	Liquid pipe	mm	Φ6.35	Φ9.52	Φ9.52	Φ9.52
	Gas pipe	mm	Φ12.7	Φ15.9	Φ15.9	Φ15.9
Drain pipe	External diameter × thickness	mm	Φ20×1.5	Φ20×1.5	Φ20×1.5	Φ20×1.5
Dimensions	W×D×H	mm	940×200×298	1008×221×319	1008×221×319	1008×221×319
Net weight	Main body	kg	12.5	15.0	15.0	15.0

Notes:

- ① Rated cooling capacity test conditions: indoor 27°C DB/19°C WB, outdoor 35°C DB; connection pipe length: 5 m, without height drop between units.







# DC INVERTER MULTI VRF INDOOR UNIT TECHNICAL SALES GUIDE

- ② Rated heating capacity test conditions: indoor 20°C DB, outdoor 7°C DB/6°C WB; connection pipe length: 5 m, without height drop between units.

Model		GMV-N22G/B3A-D	GMV-N28G/B3A-D	GMV-N36G/B3A-D	GMV-N45G/B3A-D
Cooling capacity	kW	2.2	2.8	3.6	4.5
Heating capacity	kW	2.5	3.2	4.0	5.0
Air volume	m <sup>3</sup> /h	500	500	630	630
Cooling power input	W	50	50	60	60
Cooling current input	A	0.2	0.2	0.21	0.21
Heating power input	W	50	50	60	60
Heating current input	A	0.2	0.2	0.21	0.21
*Minimum line current	A	0.25	0.25	0.38	0.38
*Maximum fuse current	A	6	6	6	6
Sound pressure level	dB(A)	38	38	44	44
Power supply		208-230V 1phase ~60Hz			
Piping connection	Liquid pipe	mm	Φ6.35	Φ6.35	Φ6.35
	Gas pipe	mm	Φ9.52	Φ9.52	Φ12.7
Drain pipe	External diameter × thickness	mm	Φ20×1.5	Φ20×1.5	Φ20×1.5
Dimensions	W×D×H	mm	843×180×275	843×180×275	940×200×298
Net weight	Main body	kg	10.0	10.0	12.5

Notes:

- ① Rated cooling capacity test conditions: indoor 27°C DB/19°C WB, outdoor 35°C DB; connection pipe length: 5 m, without height drop between units.  
 ② Rated heating capacity test conditions: indoor 20°C DB, outdoor 7°C DB/6°C WB; connection pipe length: 5 m, without height drop between units.

Model		GMV-N50G/B3A-D	GMV-N56G/B3A-D	GMV-N63G/B3A-D	GMV-N71G/B3A-D
Cooling capacity	kW	5.0	5.6	6.3	7.1
Heating capacity	kW	5.8	6.3	7.0	7.5
Air volume	m <sup>3</sup> /h	630	750	750	750
Cooling power input	W	60	70	70	70
Cooling current input	A	0.21	0.31	0.31	0.31
Heating power input	W	60	70	70	70
Heating current input	A	0.21	0.31	0.31	0.31
*Minimum line current	A	0.38	0.5	0.5	0.5
*Maximum fuse current	A	6	6	6	6
Sound pressure level	dB(A)	44	44	44	44
Power supply		208-230V 1phase ~60Hz			
Piping connection	Liquid pipe	mm	Φ6.35	Φ9.52	Φ9.52
	Gas pipe	mm	Φ12.7	Φ15.9	Φ15.9
Drain pipe	External diameter × thickness	mm	Φ20×1.5	Φ20×1.5	Φ20×1.5
Dimensions	W×D×H	mm	940×200×298	1008×221×319	1008×221×319
Net weight	Main body	kg	12.5	15.0	15.0

Notes:

- ① Rated cooling capacity test conditions: indoor 27°C DB/19°C WB, outdoor 35°C DB; connection pipe length: 5 m, without height drop between units.

② Rated heating capacity test conditions: indoor 20°C DB, outdoor 7°C DB/6°C WB; connection pipe length: 5 m, without height drop between units.

Model		GMV-ND22G/A8A-T	GMV-ND28G/A8A-T	GMV-ND36G/A8A-T	GMV-ND45G/A8A-T	GMV-ND50G/A8A-T	GMV-ND56G/A8A-T	
Cooling capacity	kW	2.2	2.8	3.6	4.5	5.0	5.6	
Heating capacity	kW	2.5	3.2	4.0	5.0	5.8	6.3	
Air volume	m <sup>3</sup> /h	500	500	630	630	630	750	
Cooling power input	W	20	20	30	30	30	40	
Cooling current input	A	0.1	0.1	0.16	0.16	0.16	0.17	
Heating power input	W	20	20	30	30	30	40	
Heating current input	A	0.1	0.1	0.16	0.16	0.16	0.17	
*Minimum line current	A	0.1	0.1	0.15	0.15	0.15	0.2	
*Maximum fuse current	A	6	6	6	6	6	6	
Sound pressure level	dB(A)	38	38	44	44	44	44	
Power supply		220-240V 1 phase ~50Hz/208-230V 1 phase ~60Hz						
Piping connection	Liquid pipe	mm	Φ6.35	Φ6.35	Φ6.35	Φ6.35	Φ9.52	
	Gas pipe	mm	Φ9.52	Φ9.52	Φ12.7	Φ12.7	Φ12.7	
Drain pipe	External diameter × thickness	mm	Φ20×1.5	Φ20×1.5	Φ20×1.5	Φ20×1.5	Φ20×1.5	
Dimensions	W×D×H	mm	843×180×275	843×180×275	940×200×298	940×200×298	940×200×298	1008×221×319
Net weight	Main body	kg	10.0	10.0	12.5	12.5	12.5	15.0

Notes:

- ① Rated cooling capacity test conditions: indoor 27°C DB/19°C WB, outdoor 35°C DB; connection pipe length: 5 m, without height drop between units.
- ② Rated heating capacity test conditions: indoor 20°C DB, outdoor 7°C DB/6°C WB; connection pipe length: 5 m, without height drop between units.

Model		GMV-ND63G/A8A-T	GMV-ND71G/A8A-T	GMV-ND80G/A8A-T	GMV-ND90G/A8A-T	GMV-ND100G/A8A-T	
Cooling capacity	kW	6.3	7.1	8.0	9.0	9.5	
Heating capacity	kW	7.0	7.5	9.0	10.0	10.5	
Air volume	m <sup>3</sup> /h	750	750	1550	1550	1650	
Cooling power input	W	40	40	80	80	100	
Cooling current input	A	0.17	0.17	0.41	0.41	0.41	
Heating power input	W	40	40	80	80	100	
Heating current input	A	0.17	0.17	0.41	0.41	0.41	
*Minimum line current	A	0.2	0.2	0.2	0.2	0.2	
*Maximum fuse current	A	6	6	6	6	6	
Sound pressure level	dB(A)	44	44	49	49	52	
Power supply		220-240V 1 phase ~50Hz/208-230V 1 phase ~60Hz					
Piping connection	Liquid pipe	mm	Φ9.52	Φ9.52	Φ9.52	Φ9.52	
	Gas pipe	mm	Φ15.9	Φ15.9	Φ15.9	Φ15.9	
Drain pipe	External diameter × thickness	mm	Φ20×1.5	Φ20×1.5	Φ20×1.5	Φ20×1.5	
Dimensions	W×D×H	mm	1008×221×319	1008×221×319	1350×258×326	1350×258×326	1350×258×326

# DC INVERTER MULTI VRF INDOOR UNIT TECHNICAL SALES GUIDE

Model			GMV-ND63G/ A8A-T	GMV-ND71G/ A8A-T	GMV-ND80G/ A8A-T	GMV-ND90G/ A8A-T	GMV-ND100G/ A8A-T
Net weight	Main body	kg	15.0	15.0	18.5	18.5	18.5

Notes:

- ① Rated cooling capacity test conditions: indoor 27°C DB/19°C WB, outdoor 35°C DB; connection pipe length: 5 m, without height drop between units.
- ② Rated heating capacity test conditions: indoor 20°C DB, outdoor 7°C DB/6°C WB; connection pipe length: 5 m, without height drop between units.

Model			GMV-N22G/ A3A-T	GMV-N28G/ A3A-T	GMV-N36G/ A3A-T	GMV-N45G/ A3A-T	GMV-N50G/ A3A-T	GMV-N56G/ A3A-T	
Cooling capacity	kW		2.2	2.8	3.6	4.5	5.0	5.6	
Heating capacity	kW		2.5	3.2	4.0	5.0	5.8	6.3	
Air volume	m³/h		500	500	630	630	630	750	
Cooling power input	W		20	20	30	30	30	40	
Cooling current input	A		0.1	0.1	0.16	0.16	0.16	0.17	
Heating power input	W		20	20	30	30	30	40	
Heating current input	A		0.1	0.1	0.16	0.16	0.16	0.17	
*Minimum line current	A		0.1	0.1	0.15	0.15	0.15	0.2	
*Maximum fuse current	A		6	6	6	6	6	6	
Sound pressure level	dB(A)		38	38	44	44	44	44	
Power supply			220-240V 1 phase ~50Hz/208-230V 1 phase ~60Hz						
Piping connection	Liquid pipe	mm	Φ6.35	Φ6.35	Φ6.35	Φ6.35	Φ6.35	Φ9.52	
	Gas pipe	mm	Φ9.52	Φ9.52	Φ12.7	Φ12.7	Φ12.7	Φ15.9	
Drain pipe	External diameter × thickness	mm	Φ20×1.5	Φ20×1.5	Φ20×1.5	Φ20×1.5	Φ20×1.5	Φ20×1.5	
Dimensions	W×D×H	mm	843×180 ×275	843×180 ×275	940×200 ×298	940×200 ×298	940×200 ×298	1008×221 ×319	
Net weight	Main body	kg	10.0	10.0	12.5	12.5	12.5	15.0	

Notes:

- ① Rated cooling capacity test conditions: indoor 27°C DB/19°C WB, outdoor 35°C DB; connection pipe length: 5 m, without height drop between units.
- ② Rated heating capacity test conditions: indoor 20°C DB, outdoor 7°C DB/6°C WB; connection pipe length: 5 m, without height drop between units.

Model			GMV-D63G/ A3A-T	GMV-D71G/ A3A-T	GMV-D80G/ A3A-T	GMV-D90G/ A3A-T	GMV-D100G/ A3A-T	
Cooling capacity	kW		6.3	7.1	8.0	9.0	9.5	
Heating capacity	kW		7.0	7.5	9.0	10.0	10.5	
Air volume	m³/h		750	750	1550	1550	1650	
Cooling power input	W		40	40	80	80	100	
Cooling current input	A		0.17	0.17	0.41	0.41	0.41	
Heating power input	W		40	40	80	80	100	
Heating current input	A		0.17	0.17	0.41	0.41	0.41	
*Minimum line current	A		0.2	0.2	0.2	0.2	0.2	
*Maximum fuse current	A		6	6	6	6	6	
Sound pressure level	dB(A)		44	44	49	49	52	
Power supply			220-240V 1 phase ~50Hz/208-230V 1 phase ~60Hz					

Model			GMV-D63G/ A3A-T	GMV-D71G/ A3A-T	GMV-D80G/ A3A-T	GMV-D90G/ A3A-T	GMV-D100G/ A3A-T
Piping connection	Liquid pipe	mm	Φ9.52	Φ9.52	Φ9.52	Φ9.52	Φ9.52
	Gas pipe	mm	Φ15.9	Φ15.9	Φ15.9	Φ15.9	Φ15.9
Drain pipe	External diameter × thickness	mm	Φ20×1.5	Φ20×1.5	Φ20×1.5	Φ20×1.5	Φ20×1.5
Dimensions	W×D×H	mm	1008×221 ×319	1008×221 ×319	1350×258 ×326	1350×258 ×326	1350×258 ×326
Net weight	Main body	kg	15.0	15.0	18.5	18.5	18.5

Notes:

- ① Rated cooling capacity test conditions: indoor 27°C DB/19°C WB, outdoor 35°C DB; connection pipe length: 5 m, without height drop between units.
- ② Rated heating capacity test conditions: indoor 20°C DB, outdoor 7°C DB/6°C WB; connection pipe length: 5 m, without height drop between units.

Model			GMV-ND15G/ B4B-T	GMV-ND18G/ B4B-T	GMV-ND22G/ B4B-T	GMV-ND28G/ B4B-T	GMV-ND36G/ B4B-T	GMV-ND45G/ B4B-T	GMV-ND50G/ B4B-T
Cooling capacity	kW		1.5	1.8	2.2	2.8	3.6	4.5	5.0
Heating capacity	kW		1.8	2.2	2.5	3.2	4.0	5.0	5.6
Air volume	m³/h		500	500	500	500	630	850	850
Cooling power input	W		20	20	20	20	25	35	35
Cooling current input	A		0.1	0.1	0.1	0.1	0.12	0.17	0.17
Heating power input	W		20	20	20	20	25	35	35
Heating current input	A		0.1	0.1	0.1	0.1	0.12	0.17	0.17
*Minimum line current	A		0.1	0.1	0.1	0.1	0.15	0.15	0.15
*Maximum fuse current	A		6	6	6	6	6	6	6
Sound pressure level	dB(A)		35	35	35	35	38	43	43
Power supply			220-240V 1 phase ~50Hz/208-230V 1 phase ~60Hz						
Piping connection	Liquid pipe	mm	Φ6.35	Φ6.35	Φ6.35	Φ6.35	Φ6.35	Φ6.35	Φ6.35
	Gas pipe	mm	Φ9.52	Φ9.52	Φ9.52	Φ9.52	Φ12.7	Φ12.7	Φ12.7
Drain pipe	External diameter × thickness	mm	Φ20×1.5	Φ20×1.5	Φ20×1.5	Φ20×1.5	Φ20×1.5	Φ20×1.5	Φ20×1.5
Dimensions	W×D×H	mm	845×289 ×209	845×289 ×209	845×289 ×209	845×289 ×209	845×289 ×209	970×300 ×224	970×300 ×224
Net weight	Main body	kg	10.5	10.5	10.5	10.5	10.5	12.5	12.5

Model			GMV-ND56G/ B4B-T	GMV-ND63G/ B4B-T	GMV-ND71G/ B4B-T	GMV-ND80G/ B4B-T	GMV-ND90G/ B4B-T	GMV-ND100G/ B4B-T
Cooling capacity	kW		5.6	6.3	7.1	8.0	9.0	9.5
Heating capacity	kW		6.3	7.1	7.5	9.0	10.0	10.5
Air volume	m³/h		1100	1100	1200	1550	1550	1650
Cooling power input	W		50	50	65	80	80	100
Cooling current input	A		0.24	0.24	0.31	0.41	0.41	0.41
Heating power input	W		50	50	65	80	80	100
Heating current input	A		0.24	0.24	0.31	0.41	0.41	0.41
*Minimum line current	A		0.2	0.2	0.2	0.2	0.2	0.2
*Maximum fuse current	A		6	6	6	6	6	6
Sound pressure level	dB(A)		43	43	44	49	49	52

# DC INVERTER MULTI VRF INDOOR UNIT TECHNICAL SALES GUIDE

Model			GMV-ND56G/ B4B-T	GMV-ND63G/ B4B-T	GMV-ND71G/ B4B-T	GMV-ND80G/ B4B-T	GMV-ND90G/ B4B-T	GMV-ND100G/ B4B-T
Power supply			220-240V 1 phase ~50Hz/208-230V 1 phase ~60Hz					
Piping connection	Liquid pipe	mm	Φ9.52	Φ9.52	Φ9.52	Φ9.52	Φ9.52	Φ9.52
	Gas pipe	mm	Φ15.9	Φ15.9	Φ15.9	Φ15.9	Φ15.9	Φ15.9
Drain pipe	External diameter × thickness	mm	Φ20×1.5	Φ20×1.5	Φ20×1.5	Φ20×1.5	Φ20×1.5	Φ20×1.5
Dimensions	W×D×H	mm	1078×325 ×246	1078×325 ×246	1078×325 ×246	1350×258 ×326	1350×258 ×326	1350×258 ×326
Net weight	Main body	kg	16.0	16.0	16.0	18.5	18.5	18.5

## Notes:

- ① Rated cooling capacity test conditions: indoor 27°C DB/19°C WB, outdoor 35°C DB; connection pipe length: 5 m, without height drop between units.
- ② Rated heating capacity test conditions: indoor 20°C DB, outdoor 7°C DB/6°C WB; connection pipe length: 5 m, without height drop between units.

Model		GMV-ND15G/ B6B-T	GMV-ND18G/ B6B-T	GMV-ND22G/ B6B-T	GMV-ND28G/ B6B-T	GMV-ND36G/ B6B-T	GMV-ND45G/ B6B-T
Cooling capacity	kW	1.5	1.8	2.2	2.8	3.6	4.5
Heating capacity	kW	1.8	2.2	2.5	3.2	4.0	5.0
Air volume	m³/h	500	500	500	500	630	850
Cooling power input	W	20	20	20	20	25	35
Cooling current input	A	0.1	0.1	0.1	0.1	0.12	0.17
Heating power input	W	20	20	20	20	25	35
Heating current input	A	0.1	0.1	0.1	0.1	0.12	0.17
*Minimum line current	A	0.1	0.1	0.1	0.1	0.15	0.15
*Maximum fuse current	A	6	6	6	6	6	6
Sound pressure level	dB(A)	35	35	35	35	38	43
Power supply		220-240V 1 phase ~50Hz/208-230V 1 phase ~60Hz					
Piping connection	Liquid pipe	mm	Φ6.35	Φ6.35	Φ6.35	Φ6.35	Φ6.35
	Gas pipe	mm	Φ9.52	Φ9.52	Φ9.52	Φ9.52	Φ12.7
Drain pipe	Outer diameter × Wall thickness	mm	Φ20×1.5	Φ20×1.5	Φ20×1.5	Φ20×1.5	Φ20×1.5
Dimensions	W×D×H	mm	845×289 ×209	845×289 ×209	845×289 ×209	845×289 ×209	970×300 ×224
Net weight	Main body	kg	10.5	10.5	10.5	10.5	12.5

Model		GMV-ND50G/ B6B-T	GMV-ND56G/ B6B-T	GMV-ND63G/ B6B-T	GMV-ND71G/ B6B-T
Cooling capacity	kW	5.0	5.6	6.3	7.1
Heating capacity	kW	5.6	6.3	7.1	7.5
Air volume	m³/h	850	1100	1100	1200
Cooling power input	W	35	50	50	65
Cooling current input	A	0.17	0.24	0.24	0.31
Heating power input	W	35	50	50	65
Heating current input	A	0.17	0.24	0.24	0.31
*Minimum line current	A	0.15	0.2	0.2	0.2
*Maximum fuse current	A	6	6	6	6

Model			GMV-ND50G/ B6B-T	GMV-ND56G/ B6B-T	GMV-ND63G/ B6B-T	GMV-ND71G/ B6B-T
Sound pressure level	dB(A)		43	43	43	44
Power supply			220-240V 1 phase ~50Hz/208-230V 1 phase ~60Hz			
Piping connection	Liquid pipe	mm	Φ6.35	Φ9.52	Φ9.52	Φ9.52
	Gas pipe	mm	Φ12.7	Φ15.9	Φ15.9	Φ15.9
Drain pipe	Outer diameter × Wall thickness	mm	Φ20×1.5	Φ20×1.5	Φ20×1.5	Φ20×1.5
Dimensions	W×D×H	mm	970×300×224	1078×325×246	1078×325×246	1078×325×246
Net weight	Main body	kg	12.5	16.0	16.0	16.0

Notes:

- ① Rated cooling capacity test conditions: indoor 27°C DB/19°C WB, outdoor 35°C DB; connection pipe length: 5m, without height drop between units.
- ② Rated heating capacity test conditions: indoor 20°C DB, outdoor 7°C DB/6 °C WB; connection pipe length: 5m, without height drop between units.

Model			GMV-ND22G/C2B-T	GMV-ND28G/C2B-T	GMV-ND36G/C2B-T	GMV-ND45G/C2B-T
Cooling capacity	kW		2.2	2.8	3.6	4.5
Heating capacity	kW		2.5	3.2	4.0	5.0
Air volume	m <sup>3</sup> /h		500	500	630	850
Cooling power input	W		20	20	25	35
Cooling current input	A		0.1	0.1	0.12	0.17
Heating power input	W		20	20	25	35
Heating current input	A		0.1	0.1	0.12	0.17
*Minimum line current	A		0.1	0.1	0.15	0.15
*Maximum fuse current	A		6	6	6	6
Sound pressure level	dB(A)		35	35	38	43
Power supply			220-240V 1 phase ~50Hz/208-230V 1 phase ~60Hz			
Piping connection	Liquid pipe	mm	Φ6.35	Φ6.35	Φ6.35	Φ6.35
	Gas pipe	mm	Φ9.52	Φ9.52	Φ12.7	Φ12.7
Drain pipe	Outer diameter × Wall thickness	mm	Φ20×1.5	Φ20×1.5	Φ20×1.5	Φ20×1.5
Dimensions	W×D×H	mm	845×289×209	845×289×209	845×289×209	970×300×224
Net weight	Main body	kg	10.5	10.5	10.5	12.5

Model			GMV-ND50G/C2B-T	GMV-ND56G/C2B-T	GMV-ND63G/C2B-T	GMV-ND71G/C2B-T
Cooling capacity	kW		5.0	5.6	6.3	7.1
Heating capacity	kW		5.6	6.3	7.1	7.5
Air volume	m <sup>3</sup> /h		850	1100	1100	1200
Cooling power input	W		35	50	50	65
Cooling current input	A		0.17	0.24	0.24	0.31
Heating power input	W		35	50	50	65
Heating current input	A		0.17	0.24	0.24	0.31
*Minimum line current	A		0.15	0.2	0.2	0.2
*Maximum fuse current	A		6	6	6	6
Sound pressure level	dB(A)		43	43	43	44

# DC INVERTER MULTI VRF INDOOR UNIT TECHNICAL SALES GUIDE

Model			GMV-ND50G/C2B-T	GMV-ND56G/C2B-T	GMV-ND63G/C2B-T	GMV-ND71G/C2B-T
Power supply			220-240V 1 phase ~50Hz/208-230V 1 phase ~60Hz			
Piping connection	Liquid pipe	mm	Φ6.35	Φ9.52	Φ9.52	Φ9.52
	Gas pipe	mm	Φ12.7	Φ15.9	Φ15.9	Φ15.9
Drain pipe	Outer diameter × Wall thickness	mm	Φ20×1.5	Φ20×1.5	Φ20×1.5	Φ20×1.5
Dimensions	W×D×H	mm	970×300×224	1078×325×246	1078×325×246	1078×325×246
Net weight	Main body	kg	12.5	16.0	16.0	16.0

## Notes:

- ① Rated cooling capacity test conditions: indoor 27°C DB/19°C WB, outdoor 35°C DB; connection pipe length: 5m, without height drop between units.
- ② Rated heating capacity test conditions: indoor 20°C DB, outdoor 7°C DB/6 °C WB; connection pipe length: 5m, without height drop between units.

Model			GMV-ND22G/C4B-T	GMV-ND28G/C4B-T	GMV-ND36G/C4B-T	GMV-ND45G/C4B-T
Cooling capacity	kW		2.2	2.8	3.6	4.5
Heating capacity	kW		2.5	3.2	4.0	5.0
Air volume	m³/h		500	500	630	850
Cooling power input	W		20	20	25	35
Cooling current input	A		0.1	0.1	0.12	0.17
Heating power input	W		20	20	25	35
Heating current input	A		0.1	0.1	0.12	0.17
*Minimum line current	A		0.1	0.1	0.15	0.15
*Maximum fuse current	A		6	6	6	6
Sound pressure level	dB(A)		35	35	38	43
Power supply			220-240V 1 phase ~50Hz/208-230V 1 phase ~60Hz			
Piping connection	Liquid pipe	mm	Φ6.35	Φ6.35	Φ6.35	Φ6.35
	Gas pipe	mm	Φ9.52	Φ9.52	Φ12.7	Φ12.7
Drain pipe	Outer diameter × Wall thickness	mm	Φ20×1.5	Φ20×1.5	Φ20×1.5	Φ20×1.5
Dimensions	W×D×H	mm	845×289×209	845×289×209	845×289×209	970×300×224
Net weight	Main body	kg	10.5	10.5	10.5	12.5

Model			GMV-ND50G/C4B-T	GMV-ND56G/C4B-T	GMV-ND63G/C4B-T	GMV-ND71G/C4B-T
Cooling capacity	kW		5.0	5.6	6.3	7.1
Heating capacity	kW		5.6	6.3	7.1	7.5
Air volume	m³/h		850	1100	1100	1200
Cooling power input	W		35	50	50	65
Cooling current input	A		0.17	0.24	0.24	0.31
Heating power input	W		35	50	50	65
Heating current input	A		0.17	0.24	0.24	0.31
*Minimum line current	A		0.15	0.2	0.2	0.2
*Maximum fuse current	A		6	6	6	6





# DC INVERTER MULTI VRF INDOOR UNIT TECHNICAL SALES GUIDE

Model			GMV-ND50G/D2B-T	GMV-ND56G/D2B-T	GMV-ND63G/D2B-T	GMV-ND71G/D2B-T
Power supply			220-240V 1 phase ~50Hz/208-230V 1 phase ~60Hz			
Piping connection	Liquid pipe	mm	Φ6.35	Φ9.52	Φ9.52	Φ9.52
	Gas pipe	mm	Φ12.7	Φ15.9	Φ15.9	Φ15.9
Drain pipe	External diameter × thickness	mm	Φ20×1.5	Φ20×1.5	Φ20×1.5	Φ20×1.5
Dimensions	W×D×H	mm	970×300×224	1078×325×246	1078×325×246	1078×325×246
Net weight	Main body	kg	12.5	16.0	16.0	16.0

## Notes:

- ① Rated cooling capacity test conditions: indoor 27°C DB/19°C WB, outdoor 35°C DB; connection pipe length: 5 m, without height drop between units.
- ② Rated heating capacity test conditions: indoor 20°C DB, outdoor 7°C DB/6°C WB; connection pipe length: 5 m, without height drop between units.

## 2.7 Fresh Air Processing Unit

Model			GMV-NX450P/A(X4.0) -M
Cooling capacity	kW		45
Heating capacity	kW		32
Air volume	m³/h		4000
Static pressure (Pa)	Standard		200
	Optional		300
Cooling power input	W		1240
Cooling current input	A		3.40
Heating power input	W		1240
Heating current input	A		3.40
Minimum line current	A		6.5
Maximum fuse current	A		7.6
Sound pressure level	dB(A)		58
Power supply			380~415V 3N~50Hz
Piping connection	Liquid pipe	mm	Φ12.7
	Gas pipe	mm	Φ28.6
Drain pipe	External diameter × thickness	mm	Φ33×3
Dimensions	W×D×H	mm	1700×1100×650
Net weight	Main body	kg	208

## Notes:

- ① Rated cooling capacity test conditions: fresh air inlet 35°C DB/28°C WB; connection pipe length: 5 m, without height drop between units.
- ② Rated heating capacity test conditions: fresh air inlet 7°C DB/6°C WB; connection pipe length: 5 m, without height drop between units.
- ③ Defaulted ex-factory of cooling air outlet temperature is set to 18°C and the heating air outlet temperature is set to 22°C.

### DC Inverter Fresh Air Processing Indoor

Model			GMV-NDX125P/A-T	GMV-NDX140P/A-T	GMV-NDX224P/A-T
Cooling capacity	kW		12.5	14.0	22.4
Heating capacity	kW <sup>1</sup>		8.5	10.0	16.0
	kW <sup>2</sup>		10.5	12.0	20.0
Air volume	m <sup>3</sup> /h		1200/1000~2000	1200/1000~2000	2000/2000~3500
Static pressure (Pa)	Standard		150	150	200
	Optional		50~200	50~200	50~300
Cooling power input	W		200	200	400
Cooling current input	A		1.5	1.5	2.5
Heating power input	W		200	200	400
Heating current input	A		1.5	1.5	2.5
Minimum line current	A		2.1	2.1	6.3
Maximum fuse current	A		6	6	10
Sound pressure level	dB(A)		40~50	40~50	45~54
Power supply			220-240V ~50Hz & 208-230V ~60Hz		
Piping connection	Liquid pipe	mm	Φ9.52	Φ9.52	Φ9.52
	Gas pipe	mm	Φ15.9	Φ15.9	Φ19.05
Drain pipe	External diameter × thickness	mm	Φ25×2.5	Φ25×2.5	Φ25×2
Dimensions	W×D×H	mm	1400×700×300	1400×700×300	1483×791×385
Net weight	Main body	kg	54	54	82

Model			GMV-NDX250P/A-T	GMV-NDX280P/A-T
Cooling capacity	kW		25.0	28.0
Heating capacity	kW <sup>1</sup>		18.0	20.0
	kW <sup>2</sup>		20.0	22.0
Air volume	m <sup>3</sup> /h		2500/2000~3500	2500/2000~3500
Static pressure (Pa)	Standard		200	200
	Optional		50~300	50~300
Cooling power input	W		520	520
Cooling current input	A		3.1	3.1
Heating power input	W		520	520
Heating current input	A		3.1	3.1
Minimum line current	A		6.3	6.3
Maximum fuse current	A		10	10
Sound pressure level	dB(A)		47~54	47~54
Power supply			220-240V ~50Hz & 208-230V ~60Hz	
Piping connection	Liquid pipe	mm	Φ9.52	Φ9.52
	Gas pipe	mm	Φ22.2	Φ22.2
Drain pipe	External diameter × thickness	mm	Φ25×2	Φ25×2
Outline Dimensions	W×D×H	mm	1483×791×385	1483×791×385
Net weight		kg	82	82

**Notes:**

- ① Rated cooling capacity test conditions: indoor 35°C DB/28°C WB, outdoor 35°C DB; connection pipe length: 7.5m, without height drop between units.
- ② Rated heating capacity test conditions: \*1:indoor 7°C DB/6 °C WB, outdoor 7°C DB/6 °C WB, \*2: indoor 0°C DB / -2.9°C, outdoor 0°C DB / -2.9°C WB; connection pipe length: 7.5m, without height drop between units.
- ③ Defaulted ex-factory of cooling air outlet temperature is set to 18°C and the heating air outlet temperature is set to 22°C.
- ④ In the column of “Air Volume”: The figure before “/” indicates the default air volume of unit before delivery, and the figures after indicate the adjustable air volume range of unit.
- ⑤ The sound pressure level will change with the static pressure.

Fresh air series indoor unit have three kinds of connection according to different models:

(1) If the number of connected indoor units is more than one and connecting with conventional VRF indoor units:

Optional indoor unit model	Connected outdoor unit series	Connection condition
GMV-NDX125P/A-T GMV-NDX140P/A-T GMV-NDX224P/A-T GMV-NDX250P/A-T GMV-NDX280P/A-T	GMV5 GMV6	1) The total capacity of connected fresh air indoor units and connecting with conventional VRF indoor units cannot exceed 50%~100% of the capacity of outdoor units; 2) The total capacity of connected fresh air indoor units cannot exceed 30% of the capacity of outdoor units.

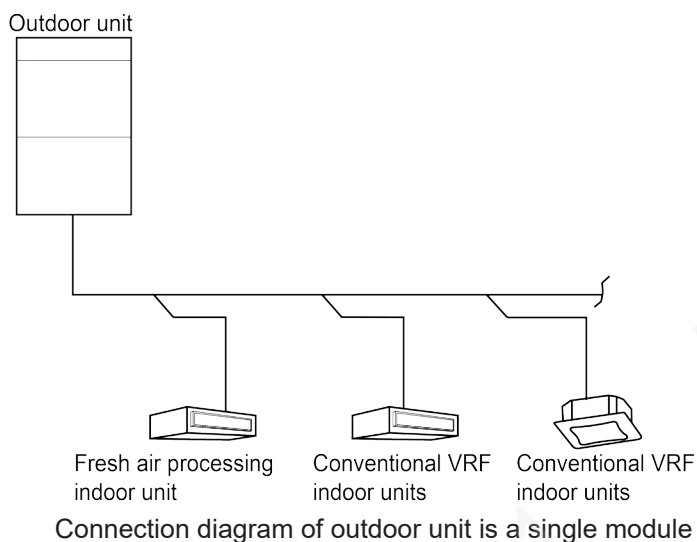

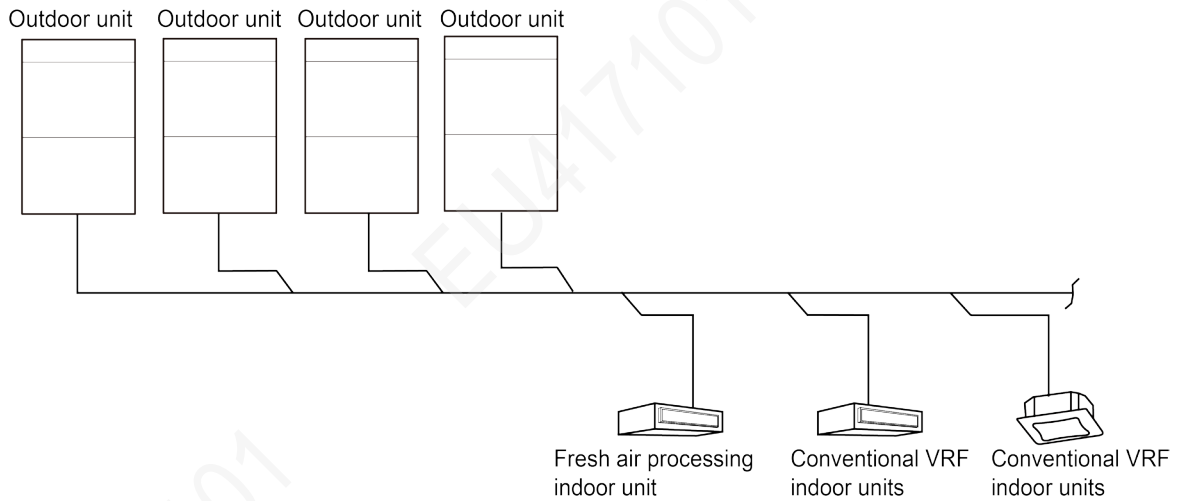

Connection diagram of outdoor units is modular

(2) If the number of connected indoor units is more than one and all of them are VRF fresh air indoor units:

Optional indoor unit model	Connected outdoor unit series	Connection condition
GMV-NDX125P/A-T GMV-NDX140P/A-T GMV-NDX224P/A-T GMV-NDX250P/A-T GMV-NDX280P/A-T	GMV5 GMV6 GMV Slim*	The total capacity of connected fresh air indoor units cannot exceed 50%~100% of the capacity of outdoor units.
GMV-NX450P/A(X4.0)-M	GMV5 GMV6	1) Can not connected other models of indoor units 2) The total capacity of connected fresh air indoor units cannot exceed 50%~100% of the capacity of outdoor units.

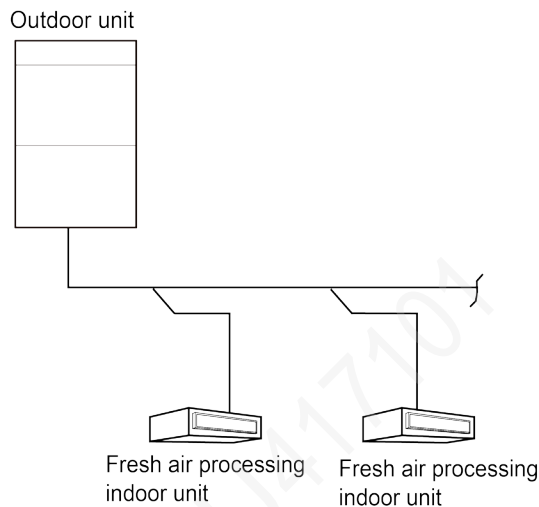

Connection diagram of outdoor unit is a single module

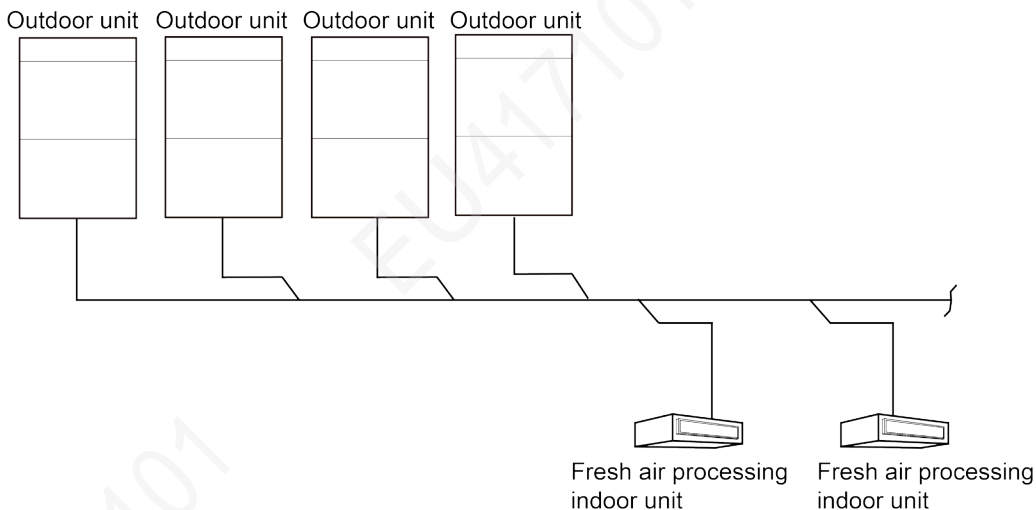

Connection diagram of outdoor units is modular

(3) If the number of connected indoor units is only one and it is VRF fresh air indoor unit:

Optional indoor unit model	Recommended capacity of outdoor unit	Connected outdoor unit series	Connection condition
GMV-NDX125P/A-T	12kW	GMV Mini*	The capacity of outdoor unit is not less than the recommended capacity and cannot exceed 10% of the recommended capacity.
GMV-NDX140P/A-T	14kW		
GMV-NDX224P/A-T	22.4kW	GMV5 GMV6 GMV Slim*	
GMV-NDX250P/A-T	28kW		
GMV-NDX280P/A-T	28kW		
GMV-NX450P/A(X4.0)-M	45kW	GMV5 GMV6	

Notes:

- ① Please match the outdoor unit in strict accordance with the above requirements, otherwise, the comfortableness will be affected or even the unit will be damaged.
- ② If the VRF fresh air indoor unit match with GMV Slim series or GMV Mini series, please consult technical staffs for details.

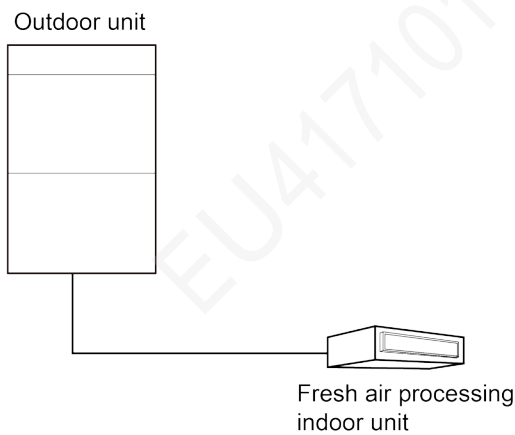

Connection diagram of only one VRF fresh air indoor unit system

## 2.8 Console Type

Model		GMV-ND22C/A-T	GMV-ND28C/A-T	GMV-ND36C/A-T	GMV-ND45C/A-T	GMV-ND50C/A-T
Cooling capacity	kW	2.2	2.8	3.6	4.5	5.0
Heating capacity	kW	2.5	3.2	4.0	5.0	5.5
Air volume	m <sup>3</sup> /h	400	400	480	680	680
Cooling power input	W	15	15	20	40	40
Cooling current input	A	0.17	0.17	0.25	0.4	0.4
Heating power input	W	15	15	20	40	40
Heating current input	A	0.17	0.17	0.25	0.4	0.4
*Minimum line current	A	/	/	/	/	/
*Maximum fuse current	A	/	/	/	/	/
Sound pressure level	dB(A)	38	38	40	46	46
Power supply		220-240V 1phase ~50Hz 208-230V 1phase ~60Hz				
Piping connection	Liquid pipe	mm	Φ6.35	Φ6.35	Φ6.35	Φ6.35
	Gas pipe	mm	Φ9.52	Φ9.52	Φ12.7	Φ12.7
Drain pipe	External diameter × thickness	mm	Φ28×1	Φ28×1	Φ28×1	Φ28×1
Dimensions	W×D×H	mm	700×215×600	700×215×600	700×215×600	700×215×600
Net weight	Main body	kg	16	16	16	16

## 2.9 Floor Standing Type

Model		GMV-ND100L/A-T	GMV-ND140L/A-T
Cooling capacity	kW	10	14
Heating capacity	kW	11	15
Air volume	m <sup>3</sup> /h	1850	1850
Cooling power input	W	200	200
Cooling current input	A	1.5	1.5
Heating power input	W	200	200
Heating current input	A	1.5	1.5
Minimum line current	A	/	/
Maximum fuse current	A	/	/
Sound pressure level	dB(A)	50	50
Power supply		220-240V 1phase ~50Hz 208-230V 1phase ~60Hz	
Piping connection	Liquid pipe	mm	Φ9.52
	Gas pipe	mm	Φ15.9
Drain pipe	External diameter × thickness	mm	Φ31×4.5
Dimensions	W×D×H	mm	1870×580×400
Net weight	Main body	kg	57

## 2.10 Compact Four-way Cassette Type

Model		GMV-ND22T/B-T	GMV-ND28T/B-T	GMV-ND36T/B-T	GMV-ND45T/B-T	GMV-ND50T/B-T	GMV-ND56T/B-T
Cooling capacity	kW	2.2	2.8	3.6	4.5	5.0	5.6
Heating capacity	kW	2.5	3.2	4.0	5.0	5.6	6.3



# DC INVERTER MULTI VRF INDOOR UNIT TECHNICAL SALES GUIDE

Model		GMV-ND22T/ B-T	GMV-ND28T/ B-T	GMV-ND36T/ B-T	GMV-ND45T/ B-T	GMV-ND50T/ B-T	GMV-ND56T/ B-T
Air volume	m <sup>3</sup> /h	600	600	600	700	700	700
Cooling power input	W	35	35	35	45	45	45
Cooling current input	A	0.4	0.4	0.4	0.5	0.5	0.5
Heating power input	W	35	35	35	45	45	45
Heating current input	A	0.4	0.4	0.4	0.5	0.5	0.5
Minimum line current	A	0.5	0.5	0.5	0.63	0.63	0.63
Maximum fuse current	A	6	6	6	6	6	6
Sound pressure level	dB(A)	41	41	41	45	45	45
Power supply		220-240V ~50Hz & 208-230V ~60Hz					
Piping connection	Liquid pipe	mm	Φ6.35	Φ6.35	Φ6.35	Φ6.35	Φ9.52
	Gas pipe	mm	Φ9.52	Φ9.52	Φ12.7	Φ12.7	Φ15.9
Drain pipe	External diameter × Thickness	mm	Φ25×2.5	Φ25×2.5	Φ25×2.5	Φ25×2.5	Φ25×2.5
Main body dimensions	W×D×H	mm	596×596×240	596×596×240	596×596×240	596×596×240	596×596×240
Panel dimensions	W×D×H	mm	670×670×50	670×670×50	670×670×50	670×670×50	670×670×50
Net weight	Main body	kg	20.5	20.5	20.5	20.5	20.5
	Panel	kg	3.5	3.5	3.5	3.5	3.5

## 2.11 360° Air Discharge Compact Cassette Indoor Unit

Model		GMV-ND15T/E-T	GMV-ND18T/E-T	GMV-ND22T/E-T	GMV-ND28T/E-T
Cooling capacity	kW	1.5	1.8	2.2	2.8
Heating capacity	kW	1.8	2.2	2.5	3.2
Air Volume(H/M/L)	m <sup>3</sup> /h	460/420/370	460/420/370	500/460/370	570/480/420
External Static Pressure	Pa	0	0	0	0
Cooling power input	W	30	30	30	30
Cooling current input	A	0.15	0.15	0.15	0.15
Heating power input	W	30	30	30	30
Heating current input	A	0.15	0.15	0.15	0.15
Minimum line current	A	0.2	0.2	0.2	0.2
Maximum fuse current	A	6	6	6	6
Sound pressure level (H/M/L)	dB(A)	33/30/25	33/30/25	36/31/25	36/33/28
Power supply		220-240V ~50Hz & 208-230V ~60Hz			
Piping connection	Liquid pipe	mm	Φ6.35	Φ6.35	Φ6.35
	Gas pipe	mm	Φ9.52	Φ9.52	Φ9.52
Drain pipe	External diameter × thickness	mm	Φ25×2.5	Φ25×2.5	Φ25×2.5
Outline Dimensions	W×D×H	mm	570×570×265	570×570×265	570×570×265
Net weight	kg	17.5	17.5	17.5	17.5

Model		GMV-ND36T/E-T	GMV-ND45T/E-T	GMV-ND50T/E-T	GMV-ND56T/E-T
Cooling capacity	kW	3.6	4.5	5.0	5.6
Heating capacity	kW	4.0	5.0	5.6	6.3
Air Volume(H/M/L)	m <sup>3</sup> /h	620/550/480	730/650/560	730/650/560	730/650/560
External Static Pressure	Pa	0	0	0	0

Model		GMV-ND36T/E-T	GMV-ND45T/E-T	GMV-ND50T/E-T	GMV-ND56T/E-T	
Cooling power input	W	30	45	45	45	
Cooling current input	A	0.15	0.23	0.23	0.23	
Heating power input	W	30	45	45	45	
Heating current input	A	0.15	0.23	0.23	0.23	
Minimum line current	A	0.2	0.3	0.3	0.3	
Maximum fuse current	A	6	6	6	6	
Sound pressure level (H/M/L)	dB(A)	39/37/35	43/41/39	43/41/39	43/41/39	
Power supply		220-240V ~50Hz & 208-230V ~60Hz				
Piping connection	Liquid pipe	mm	Φ6.35	Φ6.35	Φ6.35	Φ9.52
	Gas pipe	mm	Φ12.7	Φ12.7	Φ12.7	Φ15.9
Drain pipe	External diameter × thickness	mm	Φ25×2.5	Φ25×2.5	Φ25×2.5	Φ25×2.5
Outline Dimensions	W×D×H	mm	570×570×265	570×570×265	570×570×265	570×570×265
Net weight		kg	17.5	17.5	17.5	17.5

## 2.12 AHU-KIT Type

Model		GMV-N36U/C-T	GMV-N71U/C-T			GMV-N140U/C-T					
Defaulted capacity of ex-factory	Capacity		36		71			140			
	Cooling	kW	3.6		7.1			14			
	Heating	kW	4		8			16			
Adjustable capacity	Capacity		28	36	45	56	71	90	112	140	
	Cooling	kW	2.8	3.6	4.5	5.6	7.1	9	11.2	14	
	Heating	kW	3.2	4	5	6.3	8	10	12.5	16	
Power input		W	8		8			8			
Power Supply		V/Ph/Hz	220-240V ~50Hz & 208-230V ~60Hz								
Size of connection pipe	AHU-KIT (ex-factory pipe size)		mm	Φ6.35	Φ6.35	Φ9.52	Φ9.52	Φ9.52	Φ9.52	Φ9.52	Φ9.52
	Air handling unit	Liquid pipe	mm	Φ6.35	Φ6.35	Φ6.35	Φ9.52	Φ9.52	Φ9.52	Φ9.52	Φ9.52
		Gas pipe	mm	Φ9.52	Φ12.7	Φ12.7	Φ15.9	Φ15.9	Φ15.9	Φ15.9	Φ15.9
	Connection method		—	Brazing Connection		Brazing Connection			Brazing Connection		
Outline dimension (W×D×H)	EXV box	mm	203×326×85		203×326×85			203×326×85			
	Control box	mm	334×284×111		334×284×111			334×284×111			
Packing size(W×D×H)		mm	539×461×247		539×461×247			539×461×247			
Net weight		kg	10.0		10.5			10.5			

Model		GMV-N280U/C-T					GMV-N560U/C-T			
Defaulted capacity of ex-factory	Capacity		280					560		
	Cooling	kW	28					56		
	Heating	kW	31.5					63		
Adjustable capacity	Capacity		224	280	335	280	450	504	560	840
	Cooling	kW	22.4	28	33.5	28	45	50.4	56	84
	Heating	kW	25	31.5	37.5	45	50	56.5	63	94.5
Power input		W	8					8		

# DC INVERTER MULTI VRF INDOOR UNIT TECHNICAL SALES GUIDE

Model			GMV-N280U/C-T					GMV-N560U/C-T			
Power Supply		V/Ph/Hz	220-240V ~50Hz & 208-230V ~60Hz								
Size of connection pipe	AHU-KIT (ex-factory pipe size)		mm	Φ9.52	Φ9.52	Φ9.52	Φ9.52	Φ9.52	Φ15.9	Φ15.9	Φ15.9
	Air handling unit	Liquid pipe	mm	Φ9.52	Φ9.52	Φ12.7	Φ12.7	Φ12.7	Φ15.9	Φ15.9	Φ19.05
		Gas pipe	mm	Φ19.05	Φ22.2	Φ25.4	Φ25.4	Φ28.6	Φ28.6	Φ28.6	Φ31.8
	Connection method		—	Brazing Connection							
Outline dimension (W×D×H)	EXV box		mm	203×326×85					246×500×120		
	Control box		mm	334×284×111					334×284×111		
Packing size(W×D×H)		mm	539×461×247					759×645×180			
Net weight		kg	10.5					13.0			

Model(Combined)			GMV-N560U/C-T +GMV-N140U/C-T		GMV-N560U/C-T +GMV-N280U/C-T		GMV-N560U/C-T +GMV-N560U/C-T			
Capacity			840+140		840+280		840+560		840+840	
Cooling		kW	98		112		140		168	
Heating		kW	110.5		126		157.5		189	
power input		W	8+8		8+8		8+8			
Power Supply		V/Ph/Hz	220-240V ~50Hz & 208-230V ~60Hz							
Size of connection pipe	Air handling unit	Liquid pipe	mm	Φ19.05		Φ19.05		Φ19.05		Φ19.05
		Gas pipe	mm	Φ38.1		Φ38.1		Φ41.3		Φ41.3
Outline dimension (W×D×H)	EXV box		mm	246×500×120 +203×326×85		246×500×120 +203×326×85		(246×500×120)×2		
	Control box		mm	(334×284×111)×2		(334×284×111)×2		(334×284×111)×2		
Net weight		kg	13.0+10.5		13.0+10.5		13.0+13.0			

Model(Combined)			GMV-N560U/C-T +GMV-N560U/C-T +GMV-N140U/C-T		GMV-N560U/C-T +GMV-N560U/C-T +GMV-N280U/C-T		GMV-N560U/C-T +GMV-N560U/C-T +GMV-N560U/C-T			
Capacity			840+840+140		840+840+280		840+840+560		840+840+840	
Cooling		kW	182		196		224		252	
Heating		kW	204.5		220.5		252		283.5	
power input		W	8+8+8		8+8+8		8+8+8			
Power Supply		V/Ph/Hz	220-240V ~50Hz & 208-230V ~60Hz							
Size of connection pipe	Air handling unit	Liquid pipe	mm	Φ19.05		Φ22.2		Φ22.2		Φ22.2
		Gas pipe	mm	Φ41.3		Φ44.5		Φ44.5		Φ44.5
Outline dimension (W×D×H)	EXV box		mm	(246×500×120)×2 +203×326×85		(246×500×120)×2 +203×326×85		(246×500×120)×3		
	Control box		mm	(334×284×111)×3		(334×284×111)×3		(334×284×111)×3		
Net weight		kg	13.0+13.0+10.5		13.0+13.0+10.5		13.0+13.0+13.0			

Note:

The specifications of the unit is subject to change without prior notice due to improvement product. Please refer to the nameplate.

### 2.12.1 Recommended Selecting the Air Handling Unit

Select the air handling unit according to the technical data and limitations mentioned in the following table. Lifetime of the unit, operation range or operation reliability may be influenced if you neglect these limitations.

Model(Combined)	Capacity (kW)	Allowed Heat Exchanger Capacity(kW)			
		Cooling		Heating	
		Min	Max	Min	Max
GMV-N36U/C-T	2.8	2.5	2.8	2.8	3.2
	3.6	2.8	3.6	3.2	4
GMV-N71U/C-T	4.5	3.6	4.5	4	5
	5.6	4.5	5.6	5	6.3
	7.1	5.6	7.1	6.3	8
GMV-N140U/C-T	9	7.1	9	8	10
	11.2	9	11.2	10	12.5
	14	11.2	14	12.5	16
GMV-N280U/C-T	22.4	14	22.4	16	25
	28	22.4	28	25	31.5
	33.5	28	33.5	31.5	37.5
	40	33.5	40	37.5	45
	45	40	45	45	50
GMV-N560U/C-T	50.4	45	50.4	50	56.5
	56	50.4	56	56.5	63
	84	56	84	63	94.5
GMV-N560U/C-T +GMV-N140U/C-T	98	84	98	94.5	110.5
GMV-N560U/C-T +GMV-N280U/C-T	112	98	112	110.5	126
GMV-N560U/C-T +GMV-N560U/C-T	140	112	140	126	157.5
	168	140	168	157.5	189
GMV-N560U/C-T +GMV-N560U/C-T +GMV-N140U/C-T	182	168	182	189	204.5
GMV-N560U/C-T +GMV-N560U/C-T +GMV-N280U/C-T	196	182	196	204.5	220.5
GMV-N560U/C-T +GMV-N560U/C-T +GMV-N560U/C-T	224	196	224	220.5	252
	252	224	272	252	306

- a) The capacity is obtained at these test conditions: superheat (SH) = 5°C and supercool (SC) = 3°C.  
Cooling: Saturated evaporating temperature = 6°C, air return temperature is 27°C (DB)/19°C (WB).  
Heating: Saturated condensing temperature = 46°C, air return temperature is 20°C (DB).
- b) The heat exchanger of air handling unit is designed for R410A, and its working pressure is 4.3MPa.
- c) Recommendation: Quantity of rows of heat exchanger: no more than 4 rows.
- d) Recommendation: The diameter of copper pipe of heat exchanger is no more than 12.7mm, 9.52mm is recommended.
- e) Air inlet temperature range of heat exchanger: cooling: 16~35°C, heating: 10~27°C.

**Note:**

When the AHU-KIT is matched with AHU, they can connect with VRF outdoor unit as VRF indoor unit. The connection is limited by the outdoor unit. There are three kinds of connection method:

(1) Connection method 1: one-to-one

The AHU-KIT as below can adopt one-to-one connection method with VRF outdoor unit. Total capacity

of AHU-KIT should be 50%~110% of that of outdoor unit.

Model(Combined)	Capacity in application (kW)	Capacity index
GMV-N71U/C-T	7.1	71
GMV-N140U/C-T	9	90
	11.2	112
	14	140
GMV-N280U/C-T	22.4	224
	28	280
	33.5	335
	40	400
	45	450
GMV-N560U/C-T	50.4	504
	56	560
	84	840
GMV-N560U/C-T+GMV-N140U/C-T	98	840+140
GMV-N560U/C-T+GMV-N280U/C-T	112	840+280
GMV-N560U/C-T+GMV-N560U/C-T	140	840+560
	168	840+840
GMV-N560U/C-T+GMV-N560U/C-T+GMV-N140U/C-T	182	840+840+140
GMV-N560U/C-T+GMV-N560U/C-T+GMV-N280U/C-T	196	840+840+280
GMV-N560U/C-T+GMV-N560U/C-T+GMV-N560U/C-T	224	840+840+560
	252	840+840+840

(2) Connection method 2: one-to-more

The AHU-KIT as below can adopt one-to-more connection method with VRF outdoor unit. Total capacity of AHU-KIT should be 50%~110% of that of outdoor unit.

Model	Capacity in application (kW)	Capacity index
GMV-N36U/C-T	2.8	28
	3.6	36
GMV-N71U/C-T	4.5	45
	5.6	56
	7.1	71
GMV-N140U/C-T	9	90
	11.2	112
	14	140
GMV-N280U/C-T	22.4	224
	28	280
GMV-N560U/C-T	50.4	504
	56	560
	84	840

Note:2.8~28kW units can be connected to a system; 22.4~84kW units can be connected to a system.

(3) Connection method 3: one-to-more (mixed connection)

The AHU-KIT as below can adopt one-to-more connection method with general VRF indoor unit. Total capacity of AHU-KIT and VRF indoor unit should be 50%~110% of that of outdoor unit. Total capacity of AHU-KIT cannot exceed 30% of that of outdoor unit.

Model	Capacity in application (kW)	Capacity index
GMV-N36U/C-T	2.8	28
	3.6	36
GMV-N71U/C-T	4.5	45
	5.6	56
	7.1	71
GMV-N140U/C-T	9	90
	11.2	112
	14	140
GMV-N280U/C-T	22.4	224
	28	280

Notes:

- ① When connecting AHU-KIT with general VRF indoor unit, capacity requirement shall be followed strictly. Otherwise, it may affect the operation, or even damage the unit.
- ② One-to-more means matching between indoor unit and outdoor unit.

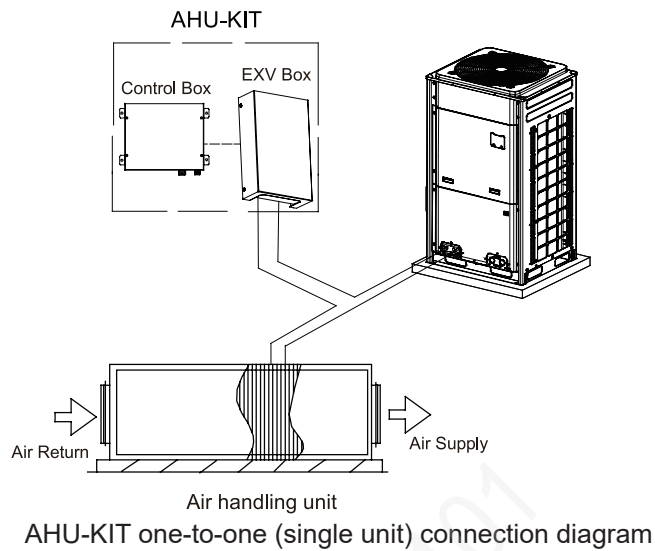

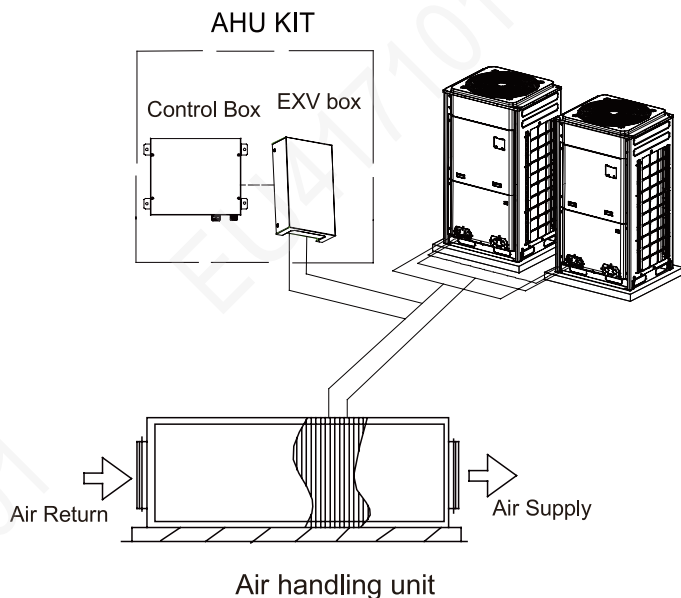

AHU-KIT one-to-one (combination outdoor unit) connection diagram

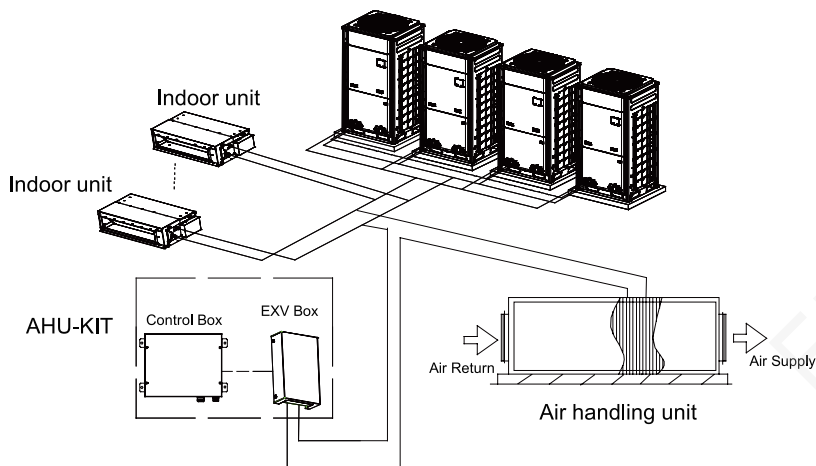

AHU-KIT one-to-more (hybrid connection) connection diagram

## 2.13 Two-way Cassette Type

Model		GMV-ND28TS/A-T	GMV-ND36TS/A-T	GMV-ND45TS/A-T	GMV-ND50TS/A-T
Cooling capacity	kW	2.8	3.6	4.5	5.0
Heating capacity	kW	3.2	4.0	5.0	5.6
Air volume(H/M/L)	m <sup>3</sup> /h	830/660/580	830/660/580	830/660/580	830/660/580
Cooling power input	W	55	55	55	55
Cooling current input	A	0.4	0.4	0.4	0.4
Heating power input	W	55	55	55	55
Heating current input	A	0.4	0.3	0.3	0.3
Minimum line current	A	0.5	0.5	0.5	0.5
Maximum fuse current	A	6	6	6	6
Sound pressure level (H/M/L)	dB(A)	35/32/29	35/32/29	35/32/29	35/32/29
Power supply	220-240V ~50Hz & 208-230V ~60Hz				



Model			GMV-ND28TS/A-T	GMV-ND36TS/A-T	GMV-ND45TS/A-T	GMV-ND50TS/A-T
Piping connection	Liquid pipe	mm	Φ6.35	Φ6.35	Φ6.35	Φ6.35
	Gas pipe	mm	Φ9.52	Φ12.7	Φ12.7	Φ12.7
Drain pipe	External diameter × Thickness	mm	Φ25×2.5	Φ25×2.5	Φ25×2.5	Φ25×2.5
Main body dimensions	W×D×H	mm	1200×520×315	1200×520×315	1200×520×315	1200×520×315
Panel dimensions	W×D×H	mm	1416×630×33	1416×630×33	1416×630×33	1416×630×33
Net weight	Main body	kg	43.0	43.0	43.0	43.0
	Panel	kg	7.0	7.0	7.0	7.0

Model			GMV-ND56TS/A-T	GMV-ND63TS/A-T	GMV-ND71TS/A-T
Cooling capacity	kW		5.6	6.3	7.1
Heating capacity	kW		6.3	7.1	8.0
Air volume(H/M/L)	m³/h		1100/900/750	1100/900/750	1100/900/750
Cooling power input	W		103	103	103
Cooling current input	A		0.7	0.7	0.7
Heating power input	W		103	103	103
Heating current input	A		0.7	0.7	0.7
Minimum line current	A		0.9	0.9	0.9
Maximum fuse current	A		6	6	6
Sound pressure level (H/M/L)	dB(A)		39/36/33	39/36/33	39/36/33
Power supply			220-240V ~50Hz & 208-230V ~60Hz		
Piping connection	Liquid pipe	mm	Φ9.52	Φ9.52	Φ9.52
	Gas pipe	mm	Φ15.9	Φ15.9	Φ15.9
Drain pipe	External diameter × Thickness	mm	Φ25×2.5	Φ25×2.5	Φ25×2.5
Main body dimensions	W×D×H	mm	1200×520×315	1200×520×315	1200×520×315
Panel dimensions	W×D×H	mm	1416×630×33	1416×630×33	1416×630×33
Net weight	Main body	kg	46.0	46.0	46.0
	Panel	kg	7.0	7.0	7.0

Model			GMV-ND28TS/B-T	GMV-ND36TS/B-T	GMV-ND45TS/B-T	GMV-ND50TS/B-T
Cooling capacity	kW		2.8	3.6	4.5	5.0
Heating capacity	kW		3.2	4.0	5.0	5.6
Air volume(H/M/L)	m³/h		671/616/513	671/616/513	715/616/513	715/616/513
Cooling power input	W		20	20	30	30
Cooling current input	A		0.25	0.25	0.30	0.30
Heating power input	W		20	20	30	30
Heating current input	A		0.25	0.25	0.30	0.30
Minimum line current	A		0.25	0.25	0.30	0.30
Maximum fuse current	A		6	6	6	6
Sound pressure level (H/M/L)	dB(A)		33/31/28	33/31/28	35/31/28	35/31/28
Power supply			220-240V ~50Hz & 208-230V ~60Hz			

# DC INVERTER MULTI VRF INDOOR UNIT TECHNICAL SALES GUIDE

Model			GMV-ND28TS/B-T	GMV-ND36TS/B-T	GMV-ND45TS/B-T	GMV-ND50TS/B-T
Piping connection	Liquid pipe	mm	Φ6.35	Φ6.35	Φ6.35	Φ6.35
	Gas pipe	mm	Φ9.52	Φ12.7	Φ12.7	Φ12.7
Drain pipe	External diameter × Thickness	mm	Φ25×2.5	Φ25×2.5	Φ25×2.5	Φ25×2.5
Main body dimensions	W×D×H	mm	790×630×280	790×630×280	790×630×280	790×630×280
Panel dimensions	W×D×H	mm	1100×710×28	1100×710×28	1100×710×28	1100×710×28
Net weight	Main body	kg	25.5	25.5	25.5	25.5
	Panel	kg	6.0	6.0	6.0	6.0

Model			GMV-ND56TS/B-T	GMV-ND63TS/B-T	GMV-ND71TS/B-T	GMV-ND80TS/B-T
Cooling capacity	kW		5.6	6.3	7.1	8.0
Heating capacity	kW		6.3	7.1	8.0	9.0
Air volume(H/M/L)	m³/h		764/709/676	764/709/676	816/745/660	816/745/660
Cooling power input	W		30	30	55	55
Cooling current input	A		0.30	0.30	0.49	0.49
Heating power input	W		30	30	55	55
Heating current input	A		0.30	0.30	0.49	0.49
Minimum line current	A		0.30	0.30	0.49	0.49
Maximum fuse current	A		6	6	6	6
Sound pressure level (H/M/L)	dB(A)		37/35/32	37/35/32	39/37/34	39/37/34
Power supply			220-240V ~50Hz & 208-230V ~60Hz			
Piping connection	Liquid pipe	mm	Φ9.52	Φ9.52	Φ9.52	Φ9.52
	Gas pipe	mm	Φ15.9	Φ15.9	Φ15.9	Φ15.9
Drain pipe	External diameter × Thickness	mm	Φ25×2.5	Φ25×2.5	Φ25×2.5	Φ25×2.5
Main body dimensions	W×D×H	mm	790×630×280	790×630×280	790×630×280	790×630×280
Panel dimensions	W×D×H	mm	1100×710×28	1100×710×28	1100×710×28	1100×710×28
Net weight	Main body	kg	26.0	26.0	26.0	26.0
	Panel	kg	6.0	6.0	6.0	6.0

Model			GMV-ND90 TS/B-T	GMV-ND100 TS/B-T	GMV-ND112 TS/B-T	GMV-ND125 TS/B-T	GMV-ND140 TS/B-T	GMV-ND160 TS/B-T
Cooling capacity	kW		9.0	10.0	11.2	12.5	14.0	16.0
Heating capacity	kW		10.0	11.2	12.5	14.0	16.0	18.0
Air volume(H/M/L)	m³/h		1470/1310/1275	1470/1310/1275	1470/1310/1275	1565/1400/1275	1565/1400/1275	1755/1565/1275
Cooling power input	W		90	90	90	100	100	110
Cooling current input	A		0.62	0.62	0.62	0.69	0.69	0.75
Heating power input	W		90	90	90	100	100	110
Heating current input	A		0.62	0.62	0.62	0.69	0.69	0.75
Minimum line current	A		0.62	0.62	0.62	0.69	0.69	0.75
Maximum fuse current	A		6	6	6	6	6	6
Sound pressure level (H/M/L)	dB(A)		41/39/37	41/39/37	41/39/37	43/41/39	43/41/39	46/43/40
Power supply			220-240V 1 phase ~50Hz/208-230V 1 phase ~60Hz					

Model			GMV-ND90 TS/B-T	GMV-ND100 TS/B-T	GMV-ND112 TS/B-T	GMV-ND125 TS/B-T	GMV-ND140 TS/B-T	GMV-ND160 TS/B-T
Piping interface	Liquid pipe	mm	Φ9.52	Φ9.52	Φ9.52	Φ9.52	Φ9.52	Φ9.52
	Gas pipe	mm	Φ15.9	Φ15.9	Φ15.9	Φ15.9	Φ15.9	Φ19.05
Drain pipe	External diameter ×thickness	mm	Φ25×2.5	Φ25×2.5	Φ25×2.5	Φ25×2.5	Φ25×2.5	Φ25×2.5
Main body dimensions	W×D×H	mm	1350×630×280	1350×630×280	1350×630×280	1350×630×280	1350×630×280	1350×630×280
Panel dimensions	W×D×H	mm	1660×710× 28	1660×710× 28	1660×710× 28	1660×710× 28	1660×710× 28	1660×710× 28
Net weight	Main body	kg	40.5	40.5	40.5	40.5	40.5	40.5
	Panel	kg	9.5	9.5	9.5	9.5	9.5	9.5

## 2.14 Air Handler Type Indoor Unit

Model			GMV-NR71A/ A-D	GMV-NR90A/ A-D	GMV-NR100A/ A-D	GMV-NR112A/ A-D	GMV-NR140A/ A-D	
Cooling capacity	kW		7.1	9.0	10.0	11.2	14.0	
Heating capacity	kW		8.0	10.0	11.0	12.5	15.0	
Air volume	m³/h		1600	1700	1900	2300	2400	
Cooling power input	W		215	270	370	430	550	
Cooling current input	A		1.10	1.35	2.00	2.00	2.50	
Heating power input	W		215	270	370	430	550	
Heating current input	A		1.10	1.35	2.00	2.00	2.50	
Minimum line current	A		0.4	0.4	0.4	0.5	0.5	
Maximum fuse current	A		6	6	6	6	6	
Sound pressure level	dB(A)		50	51	52	52	55	
Power supply			208-230V ~60Hz					
Piping connection	Liquid pipe	mm	Φ9.52	Φ9.52	Φ9.52	Φ9.52	Φ9.52	
	Gas pipe	mm	Φ15.9	Φ15.9	Φ15.9	Φ15.9	Φ15.9	
Drain pipe		/	G1	G1	G1	G1	G1	
Main body dimensions	W×D×H	mm	460×540×1105	460×540×1105	540×540×1224	540×540×1224	630×540×1224	
Panel dimensions	W×D×H	mm	517×620×1170	517×620×1170	597×620×1289	597×620×1289	687×621×1295	
Net weight	Main body	kg	54	57	57	68	78	

## 2.15 Super High Static Pressure Duct Type Indoor Unit

Model			GMV- ND22PHS/B-T	GMV- ND25PHS/B-T	GMV- ND28PHS/B-T	GMV- ND32PHS/B-T	GMV- ND36PHS/B-T	GMV- ND40PHS/ B-T
Cooling capacity	kW		2.2	2.5	2.8	3.2	3.6	4.0
Heating capacity	kW		2.5	2.8	3.2	3.6	4.0	4.5
Air volume	m³/h		550	550	550	600	600	850
External Static	Pa		60/0~150	60/0~150	60/0~150	60/0~150	60/0~150	60/0~150
Cooling power input	W		55	55	55	65	65	85
Cooling current input	A		0.5	0.5	0.5	0.5	0.5	0.5
Heating power input	W		55	55	55	65	65	85
Heating current input	A		0.5	0.5	0.5	0.5	0.5	0.5
Minimum line current	A		0.375	0.375	0.375	0.375	0.375	0.5
Maximum fuse current	A		6	6	6	6	6	6

# DC INVERTER MULTI VRF INDOOR UNIT TECHNICAL SALES GUIDE

Model			GMV-ND22PHS/B-T	GMV-ND25PHS/B-T	GMV-ND28PHS/B-T	GMV-ND32PHS/B-T	GMV-ND36PHS/B-T	GMV-ND40PHS/B-T
Sound pressure level	dB(A)		33	33	33	33	33	36
Power supply			220-240V ~50Hz & 208-230V ~60Hz					
Piping connection	Liquid pipe	mm	Φ6.35	Φ6.35	Φ6.35	Φ6.35	Φ6.35	Φ6.35
	Gas pipe	mm	Φ9.52	Φ9.52	Φ9.52	Φ12.7	Φ12.7	Φ12.7
Drain pipe	External diameter × Thickness	mm	Φ25×2.5	Φ25×2.5	Φ25×2.5	Φ25×2.5	Φ25×2.5	Φ25×2.5
Outline Dimensions	W×D×H	mm	700×700×300	700×700×300	700×700×300	700×700×300	700×700×300	700×700×300
Net weight	kg		32	32	32	32	32	34

Model			GMV-ND45PHS/B-T	GMV-ND50PHS/B-T	GMV-ND56PHS/B-T	GMV-ND63PHS/B-T	GMV-ND71PHS/B-T	GMV-ND80PHS/B-T
Cooling capacity	kW		4.5	5.0	5.6	6.3	7.1	8.0
Heating capacity	kW		5.0	5.6	6.3	7.1	8.0	9.0
Air volume	m³/h		850	850	1000	1000	1250	1250
External Static	Pa		60/0~150	60/0~150	90/0~200	90/0~200	90/0~200	90/0~200
Cooling power input	W		85	85	90	90	100	100
Cooling current input	A		0.5	0.5	0.8	0.8	0.8	0.8
Heating power input	W		85	85	90	90	100	100
Heating current input	A		0.5	0.5	0.8	0.8	0.8	0.8
Minimum line current	A		0.5	0.5	0.5	0.5	0.5	0.5
Maximum fuse current	A		6	6	6	6	6	6
Sound pressure level	dB(A)		36	36	37	37	38	38
Power supply			220-240V ~50Hz & 208-230V ~60Hz					
Piping connection	Liquid pipe	mm	Φ6.35	Φ6.35	Φ9.52	Φ9.52	Φ9.52	Φ9.52
	Gas pipe	mm	Φ12.7	Φ12.7	Φ15.9	Φ15.9	Φ15.9	Φ15.9
Drain pipe	External diameter × Thickness	mm	Φ25×2.5	Φ25×2.5	Φ25×2.5	Φ25×2.5	Φ25×2.5	Φ25×2.5
Outline Dimensions	W×D×H	mm	700×700×300	700×700×300	1000×700×300	1000×700×300	1000×700×300	1000×700×300
Net weight	kg		34	34	43	43	43	43

Model			GMV-ND90PHS/B-T	GMV-ND100PHS/B-T	GMV-ND112PHS/B-T	GMV-ND125PHS/B-T	GMV-ND140PHS/B-T	GMV-ND160PHS/B-T
Cooling capacity	kW		9.0	10.0	11.2	12.5	14.0	16.0
Heating capacity	kW		10.0	11.2	12.5	14.0	16.0	18.0
Air volume	m³/h		1800	1800	2000	2000	2350	2500
External Static	Pa		90/0~200	90/0~200	90/0~200	90/0~200	90/0~200	90/0~200
Cooling power input	W		140	140	160	160	220	230
Cooling current input	A		1.1	1.1	1.1	1.1	2.0	2.0
Heating power input	W		140	140	160	160	220	230
Heating current input	A		1.1	1.1	1.1	1.1	2.0	2.0
Minimum line current	A		0.75	0.75	0.875	0.875	1.25	1.25
Maximum fuse current	A		6	6	6	6	6	6
Sound pressure level	dB(A)		40	40	40	40	42	44
Power supply			220-240V ~50Hz & 208-230V ~60Hz					

Model			GMV-ND90PHS/B-T	GMV-ND100PHS/B-T	GMV-ND112PHS/B-T	GMV-ND125PHS/B-T	GMV-ND140PHS/B-T	GMV-ND160PHS/B-T
Piping connection	Liquid pipe	mm	Φ9.52	Φ9.52	Φ9.52	Φ9.52	Φ9.52	Φ9.52
	Gas pipe	mm	Φ15.9	Φ15.9	Φ15.9	Φ15.9	Φ15.9	Φ19.05
Drain pipe	External diameter × Thickness	mm	Φ25×2.5	Φ25×2.5	Φ25×2.5	Φ25×2.5	Φ25×2.5	Φ25×2.5
Outline Dimensions	W×D×H	mm	1400×700×300	1400×700×300	1400×700×300	1400×700×300	1400×700×300	1400×700×300
Net weight		kg	57	57	57	57	58	58

Model			GMV-ND180PHS/B-T	GMV-ND224PH/A-T	GMV-ND280PH/A-T	GMV-ND400PH/AR-X	GMV-ND450PH/AR-X	GMV-N560PH/AR-M
Cooling capacity	kW		18.0	22.4	28.0	40.0	45.0	56.0
Heating capacity	kW		20.0	25.0	31.0	45.0	50.0	63.0
Air volume	m³/h		3000	4000	4400	8000	8200	10000
External Static	Pa		90/0~170	/	/	/	/	/
Static pressure (Pa)	Standard		/	100	100	200	200	200
	Optional		/	50~200	50~200	50~250	50~250	/
Cooling power input	W		350	800	900	2500	2550	2700
Cooling current input	A		2.0	3.7	4.1	2.7	4.1	5.5
Heating power input	W		350	800	900	2500	2550	2700
Heating current input	A		2.0	3.7	4.1	2.7	4.1	5.5
Minimum line current	A		3.39	6	6	/	/	/
Maximum fuse current	A		6	10	10	/	/	/
Sound pressure level	dB(A)		49	54	55	61	62	63
Power supply			220-240V ~50Hz & 208-230V ~60Hz			380-415V 3N ~50/60Hz		380V 3N~50Hz
Piping connection	Liquid pipe	mm	Φ9.52	Φ9.52	Φ9.52	Φ12.7	Φ12.7	Φ15.9
	Gas pipe	mm	Φ19.05	Φ19.05	Φ22.2	Φ25.4	Φ28.6	Φ28.6
Drain pipe	External diameter × thickness	mm	Φ25×2.5	Φ25×2	Φ25×2	Φ25×2	Φ25×2	Φ25×2
Outline Dimensions	W×D×H	mm	1400×700×300	1483×791×385	1686×870×450	1680×900×650	1900×1100×700	1900×1100×850
Net weight		kg	58	82	105	170	236	282

Notes:

- ① Rated cooling capacity test conditions: indoor 27°C DB/19°C WB, outdoor 35°C DB; connection pipe length: 5 m, without height drop between units
- ② Rated heating capacity test conditions: indoor 20°C DB, outdoor 7°C DB/6°C WB; connection pipe length: 5 m, without height drop between units

### 2.16 Concealed Floor Standing Type Indoor Unit

Model		GMV-ND22ZA/A-T	GMV-ND28ZA/A-T	GMV-ND36ZA/A-T	GMV-ND45ZA/A-T	GMV-ND56ZA/A-T	GMV-ND63ZA/A-T	GMV-ND71ZA/A-T
Cooling capacity	kW	2.2	2.8	3.6	4.5	5.6	6.3	7.1
Heating capacity	kW	2.5	3.2	4.0	5.0	6.3	7.1	8.0
Air volume	m³/h	450	450	550	650	900	900	1100
External Static Pressure	Pa	10/0~40	10/0~40	10/0~40	15/0~60	15/0~60	15/0~60	15/0~60
Cooling power input	W	35	35	43	45	80	80	90
Cooling current input	A	0.18	0.18	0.22	0.23	0.41	0.41	0.46
Heating power input	W	35	35	43	45	80	80	90

# DC INVERTER MULTI VRF INDOOR UNIT TECHNICAL SALES GUIDE

Model			GMV-ND22ZA/A-T	GMV-ND28ZA/A-T	GMV-ND36ZA/A-T	GMV-ND45ZA/A-T	GMV-ND56ZA/A-T	GMV-ND63ZA/A-T	GMV-ND71ZA/A-T
Heating current input	A		0.18	0.18	0.22	0.23	0.41	0.41	0.46
Minimum line current	A		0.2	0.2	0.3	0.3	0.5	0.5	0.5
Maximum fuse current	A		6	6	6	6	6	6	6
Sound pressure level	dB(A)		30	30	33	33	35	35	37
Power supply			220-240V ~50Hz & 208-230V ~60Hz						
Piping connection	Liquid pipe	mm	Φ6.35	Φ6.35	Φ6.35	Φ6.35	Φ9.52	Φ9.52	Φ9.52
	Gas pipe	mm	Φ9.52	Φ9.52	Φ12.7	Φ12.7	Φ15.9	Φ15.9	Φ15.9
Drain pipe	External diameter × Thickness	mm	Φ25×2.5	Φ25×2.5	Φ25×2.5	Φ25×2.5	Φ25×2.5	Φ25×2.5	Φ25×2.5
Outline Dimensions	W×D×H	mm	700×615×200	700×615×200	700×615×200	900×615×200	1100×615×200	1100×615×200	1100×615×200
Net weight		kg	23	23	23	27	32	32	32

Note:

- Rated cooling capacity test conditions: indoor 27°C DB/19°C WB, outdoor 35°C DB; connection pipe length: 5 m, without height drop between units.
- Rated heating capacity test conditions: indoor 20°C DB, outdoor 7°C DB/6 °C WB; connection pipe length: 5 m, without height drop between units.
- In the column of "Unit external static pressure": The figure before "/" indicates the default external static pressure of unit before delivery, and the figures after indicate the adjustable static pressure range of unit.

## 2.17 360° Air Discharge Cassette Indoor Unit

Model			GMV-ND22T/C-T	GMV-ND28T/C-T	GMV-ND36T/C-T	GMV-ND45T/C-T
Cooling capacity	kW		2.2	2.8	3.6	4.5
Heating capacity	kW		2.5	3.2	4	5
Air volume(H/M/L)	m <sup>3</sup> /h		800/700/600	800/700/600	800/700/600	800/700/600
Cooling power input	W		26	26	26	26
Cooling current input	A		0.2	0.2	0.2	0.2
Heating power input	W		22	22	22	22
Heating current input	A		0.2	0.2	0.2	0.2
Minimum line current	A		0.50	0.50	0.50	0.50
Maximum fuse current	A		6	6	6	6
Sound Pressure Level (H/M/L)	dB(A)		33/30/28	33/30/28	33/30/28	34/30/28
Power supply			220-240V ~50Hz & 208-230V ~60Hz			
Piping connection	Liquid pipe	mm	Φ6.35	Φ6.35	Φ6.35	Φ6.35
	Gas pipe	mm	Φ9.52	Φ9.52	Φ12.7	Φ12.7
Drain pipe	External diameter × Thickness	mm	Φ25×2.5	Φ25×2.5	Φ25×2.5	Φ25×2.5
Main body dimensions	W×D×H	mm	840×840×240	840×840×240	840×840×240	840×840×240
Panel dimensions	W×D×H	mm	950×950×65	950×950×65	950×950×65	950×950×65
Net weight	Main body	kg	27	27	27	27
	Panel	kg	6	6	6	6
Panel model		/	TF06	TF06	TF06	TF06

Model			GMV-ND22T/C-T	GMV-ND28T/C-T	GMV-ND36T/C-T	GMV-ND45T/C-T
Loading Quantity	40' GP	set	120	120	120	120
	40' HQ	set	140	140	140	140

Model			GMV-ND50T/C-T	GMV-ND56T/C-T	GMV-ND63T/C-T	GMV-ND71T/C-T
Cooling capacity	kW		5	5.6	6.3	7.1
Heating capacity	kW		5.6	6.3	7.1	8
Air volume(H/M/L)	m³/h		900/800/700	950/850/750	1150/950/850	1150/950/850
Cooling power input	W		28	35	60	60
Cooling current input	A		0.2	0.2	0.4	0.4
Heating power input	W		25	35	56	56
Heating current input	A		0.2	0.2	0.4	0.4
Minimum line current	A		0.50	0.50	0.55	0.55
Maximum fuse current	A		6	6	6	6
Sound Pressure Level (H/M/L)	dB(A)		35/32/29	37/33/30	37/34/31	37/34/31
Power supply			220-240V ~50Hz & 208-230V ~60Hz			
Piping connection	Liquid pipe	mm	Φ6.35	Φ9.52	Φ9.52	Φ9.52
	Gas pipe	mm	Φ12.7	Φ15.9	Φ15.9	Φ15.9
Drain pipe	External diameter ×Thickness	mm	Φ25×2.5	Φ25×2.5	Φ25×2.5	Φ25×2.5
Main body dimensions	W×D×H	mm	840×840×240	840×840×240	840×840×240	840×840×240
Panel dimensions	W×D×H	mm	950×950×65	950×950×65	950×950×65	950×950×65
Net weight	Main body	kg	28	28	28	28
	Panel	kg	6	6	6	6
Panel model		/	TF06	TF06	TF06	TF06
Loading Quantity	40' GP	set	120	120	120	120
	40' HQ	set	140	140	140	140

Model			GMV-ND80T/C-T	GMV-ND90T/C-T	GMV-ND100T/C-T	GMV-ND112T/C-T
Cooling capacity	kW		8	9	10	11.2
Heating capacity	kW		9	10	11.2	12.5
Air volume(H/M/L)	m³/h		1250/1000/900	1250/1000/900	1250/1000/900	1650/1300/1100
Cooling power input	W		80	80	80	115
Cooling current input	A		0.4	0.4	0.4	0.6
Heating power input	W		76	76	76	111
Heating current input	A		0.4	0.4	0.4	0.6
Minimum line current	A		0.55	0.55	0.55	0.98
Maximum fuse current	A		6	6	6	6
Sound Pressure Level (H/M/L)	dB(A)		39/37/34	39/37/34	39/37/34	43/41/39
Power supply			220-240V ~50Hz & 208-230V ~60Hz			
Piping connection	Liquid pipe	mm	Φ9.52	Φ9.52	Φ9.52	Φ9.52
	Gas pipe	mm	Φ15.9	Φ15.9	Φ15.9	Φ15.9
Drain pipe	External diameter ×Thickness	mm	Φ25×2.5	Φ25×2.5	Φ25×2.5	Φ25×2.5
Main body dimensions	W×D×H	mm	840×840×240	840×840×240	840×840×240	840×840×290



# DC INVERTER MULTI VRF INDOOR UNIT TECHNICAL SALES GUIDE

Model			GMV-ND80T/C-T	GMV-ND90T/C-T	GMV-ND100T/C-T	GMV-ND112T/C-T
Panel dimensions	W×D×H	mm	950×950×65	950×950×65	950×950×65	950×950×65
Net weight	Main body	kg	29	29	29	33
	Panel	kg	6	6	6	6
Panel model		/	TF06	TF06	TF06	TF06
Loading Quantity	40' GP	set	120	120	120	120
	40' HQ	set	140	140	140	140

Model			GMV-ND125T/C-T	GMV-ND140T/C-T	GMV-ND160T/C-T
Cooling capacity	kW		12.5	14	16
Heating capacity	kW		14	16	18
Air volume(H/M/L)	m³/h		1650/1300/1100	1650/1300/1100	2000/1800/1430
Cooling power input	W		115	115	170
Cooling current input	A		0.6	0.6	1.2
Heating power input	W		111	111	170
Heating current input	A		0.6	0.6	1.2
Minimum line current	A		0.98	0.98	1.2
Maximum fuse current	A		6	6	6
Sound Pressure Level (H/M/L)	dB(A)		43/41/39	43/41/39	51/48/42
Power supply			220-240V ~50Hz & 208-230V ~60Hz		
Piping connection	Liquid pipe	mm	Φ9.52	Φ9.52	Φ9.52
	Gas pipe	mm	Φ15.9	Φ15.9	Φ19.05
Drain pipe	External diameter ×Thickness	mm	Φ25×2.5	Φ25×2.5	Φ25×2.5
Main body dimensions	W×D×H	mm	840×840×290	840×840×290	840×840×290
Panel dimensions	W×D×H	mm	950×950×65	950×950×65	950×950×65
Net weight	Main body	kg	33	33	36
	Panel	kg	6	6	6
Panel model		/	TF06	TF06	TF06
Loading Quantity	40' GP	set	120	120	120
	40' HQ	set	140	140	140

Model			GMV-ND22T/C1-T	GMV-ND28T/C1-T	GMV-ND36T/C1-T	GMV-ND45T/C1-T	GMV-ND50T/C1-T
Cooling capacity	kW		2.2	2.8	3.6	4.5	5
Heating capacity	kW		2.5	3.2	4	5	5.6
Air volume(H/M/L)	m³/h		780/690/480	800/700/500	800/700/500	1000/800/700	1000/800/700
Cooling power input	W		24	24	24	45	45
Cooling current input	A		0.21	0.21	0.21	0.37	0.37
Heating power input	W		24	24	24	45	45
Heating current input	A		0.21	0.21	0.21	0.37	0.37
Minimum line current	A		0.21	0.21	0.21	0.37	0.37
Maximum fuse current	A		6	6	6	6	6
Sound Pressure Level (H/M/L)	dB(A)		34/32/29	35/32/31	35/32/31	41/36/32	41/36/32

Model			GMV-ND22T/ C1-T	GMV-ND28T/ C1-T	GMV-ND36T/ C1-T	GMV-ND45T/ C1-T	GMV-ND50T/ C1-T
Power supply			220-240V ~50Hz & 208-230V ~60Hz				
Piping connection	Liquid pipe	mm	Φ6.35	Φ6.35	Φ6.35	Φ6.35	Φ6.35
	Gas pipe	mm	Φ9.52	Φ9.52	Φ12.7	Φ12.7	Φ12.7
Drain pipe	External diameter ×Thickness	mm	Φ25×2.5	Φ25×2.5	Φ25×2.5	Φ25×2.5	Φ25×2.5
Main body dimensions	W×D×H	mm	840×840×200	840×840×200	840×840×200	840×840×200	840×840×200
Panel dimensions	W×D×H	mm	943×923×245	943×923×245	943×923×245	943×923×245	943×923×245
Net weight	Main body	kg	21	21	21	21	21
	Panel	kg	6	6	6	6	6
Panel model		/	TF06	TF06	TF06	TF06	TF06
Loading Quantity	40' GP	set	156	156	156	156	156
	40' HQ	set	176	176	176	176	176

Model			GMV-ND22T/ D1-T	GMV-ND28T/ D1-T	GMV-ND36T/ D1-T	GMV-ND45T/ D1-T	GMV-ND50T/ D1-T
Cooling capacity	kW		2.2	2.8	3.6	4.5	5
Heating capacity	kW		2.5	3.2	4	5	5.6
Air volume(H/M/L)	m³/h		800/700/600	800/700/600	800/700/600	900/800/700	900/800/700
Cooling power input	W		40	40	40	50	50
Cooling current input	A		0.35	0.35	0.35	0.44	0.44
Heating power input	W		40	40	40	50	50
Heating current input	A		0.35	0.35	0.35	0.44	0.44
Minimum line current	A		0.35	0.35	0.35	0.44	0.44
Maximum fuse current	A		6	6	6	6	6
Sound Pressure Level (H/M/L)	dB(A)		32/29/27	32/29/27	32/29/27	35/30/27	35/30/27
Power supply			220-240V ~50Hz & 208-230V ~60Hz				
Piping connection	Liquid pipe	mm	Φ6.35	Φ6.35	Φ6.35	Φ6.35	Φ6.35
	Gas pipe	mm	Φ9.52	Φ9.52	Φ12.7	Φ12.7	Φ12.7
Drain pipe	External diameter ×Thickness	mm	Φ25×2.5	Φ25×2.5	Φ25×2.5	Φ25×2.5	Φ25×2.5
Main body dimensions	W×D×H	mm	840×840×200	840×840×200	840×840×200	840×840×200	840×840×200
Panel dimensions	W×D×H	mm	950×950×65	950×950×65	950×950×65	950×950×65	950×950×65
Net weight	Main body	kg	19	19	19	19	19
	Panel	kg	6	6	6	6	6
Panel model		/	TF06	TF06	TF06	TF06	TF06
Loading Quantity	40' GP	set	152	152	152	152	152
	40' HQ	set	169	169	169	169	169

Model			GMV-ND56T/ D1-T	GMV-ND63T/ D1-T	GMV-ND71T/ D1-T	GMV-ND80T/ D1-T	GMV-ND90T/ D1-T
Cooling capacity	kW		5.6	6.3	7.1	8	9
Heating capacity	kW		6.3	7.1	8	9	10
Air volume(H/M/L)	m³/h		1100/935/800	1100/935/800	1100/935/800	1400/1000/900	1400/1000/900
Cooling power input	W		60	60	60	75	75
Cooling current input	A		0.49	0.49	0.49	0.6	0.6

# DC INVERTER MULTI VRF INDOOR UNIT TECHNICAL SALES GUIDE

Model			GMV-ND56T/ D1-T	GMV-ND63T/ D1-T	GMV-ND71T/ D1-T	GMV-ND80T/ D1-T	GMV-ND90T/ D1-T
Heating power input	W		60	60	60	75	75
Heating current input	A		0.49	0.49	0.49	0.6	0.6
Minimum line current	A		0.49	0.49	0.49	0.6	0.6
Maximum fuse current	A		6	6	6	6	6
Sound Pressure Level (H/M/L)	dB(A)		37/35/32	37/35/32	37/35/32	40/36/31	40/36/31
Power supply			220-240V ~50Hz & 208-230V ~60Hz				
Piping connection	Liquid pipe	mm	Φ9.52	Φ9.52	Φ9.52	Φ9.52	Φ9.52
	Gas pipe	mm	Φ15.9	Φ15.9	Φ15.9	Φ15.9	Φ15.9
Drain pipe	External diameter ×Thickness	mm	Φ25×2.5	Φ25×2.5	Φ25×2.5	Φ25×2.5	Φ25×2.5
Main body dimensions	W×D×H	mm	840×840×200	840×840×200	840×840×200	840×840×240	840×840×240
Panel dimensions	W×D×H	mm	950×950×65	950×950×65	950×950×65	950×950×65	950×950×65
Net weight	Main body	kg	21	21	21	22.5	22.5
	Panel	kg	6	6	6	6	6
Panel model		/	TF06	TF06	TF06	TF06	TF06
Loading Quantity	40' GP	set	152	152	152	139	139
	40' HQ	set	169	169	169	157	157

Model			GMV-ND100T/D1-T	GMV-ND112T/D1-T	GMV-ND125T/D1-T	GMV-ND140T/D1-T
Cooling capacity	kW		10	11.2	12.5	14
Heating capacity	kW		11.2	12.5	14	16
Air volume(H/M/L)	m³/h		1550/1200/1000	1550/1200/1000	1800/1450/1150	1800/1450/1150
Cooling power input	W		100	100	160	160
Cooling current input	A		0.76	0.76	0.85	0.85
Heating power input	W		100	100	160	160
Heating current input	A		0.76	0.76	0.85	0.85
Minimum line current	A		0.76	0.76	0.85	0.85
Maximum fuse current	A		6	6	6	6
Sound Pressure Level (H/M/L)	dB(A)		43/39/35	43/39/35	46/41/35	46/41/35
Power supply			220-240V ~50Hz & 208-230V ~60Hz			
Piping connection	Liquid pipe	mm	Φ9.52	Φ9.52	Φ9.52	Φ9.52
	Gas pipe	mm	Φ15.9	Φ15.9	Φ15.9	Φ15.9
Drain pipe	External diameter ×Thickness	mm	Φ25×2.5	Φ25×2.5	Φ25×2.5	Φ25×2.5
Main body dimensions	W×D×H	mm	840×840×240	840×840×240	840×840×290	840×840×290
Panel dimensions	W×D×H	mm	950×950×65	950×950×65	950×950×65	950×950×65
Net weight	Main body	kg	22.5	22.5	25	25
	Panel	kg	6	6	6	6
Panel model		/	TF06	TF06	TF06	TF06
Loading Quantity	40' GP	set	139	139	117	117
	40' HQ	set	157	157	135	135

## 2.18 Heat Storage Module

Model			XRZ180L/A-T
power input	W		5
current input	A		0.05
Maximum fuse current	A		6
Power supply			220-240V 1 phase ~50Hz/208-230V 1 phase ~60Hz
Piping connection	Liquid pipe	mm	Φ6.35
	Gas pipe	mm	Φ12.7
Outline Dimensions (W×D×H)	mm		730×450×220
Net weight	kg		31.5

Notes:

- ① According to the capacity of outdoor unit, the number of heat storage modules is calculated. After a heat storage module is full of heat, it can meet the requirements of one 18kw unit for once heat storage and defrosting. The total capacity of heat storage modules should be within 90%~150% of that of the outdoor unit.
- ② Model selection example: The capacity of an outdoor unit GMV-335WM/H-X is 33.5KW. According to the requirement that the capacity of the heat storage module should be 90%-150% of that of outdoor unit, the capacity of the heat storage module that can be matched with the outdoor unit is 30.15KW-50.25KW. If the capacity of a single heat storage module is 18KW, the outdoor unit should be equipped with two heat storage modules. The capacity of the two heat storage modules is 36KW, which meets the capacity requirement of the heat storage modules that can be matched with the outdoor unit.

## 2.19 High Static Pressure Duct Type Indoor Unit

Model		GMV-ND22PHS/D-T	GMV-ND25PHS/D-T	GMV-ND28PHS/D-T	GMV-ND32PHS/D-T	GMV-ND36PHS/D-T	GMV-ND40PHS/D-T
Cooling capacity	kW	2.2	2.5	2.8	3.2	3.6	4.0
Heating capacity	kW	2.5	2.8	3.2	3.6	4.0	4.5
Air volume	m <sup>3</sup> /h	550	550	550	600	600	850
External Static	Pa	50/0~80	50/0~80	50/0~80	50/0~80	50/0~80	50/0~80
Cooling power input	W	50	50	50	50	50	100
Cooling current input	A	0.4	0.4	0.4	0.4	0.4	0.8
Heating power input	W	50	50	50	50	50	100
Heating current input	A	0.4	0.4	0.4	0.4	0.4	0.8
Sound pressure level	dB(A)	35	35	35	36	36	40
Power supply		220-240V ~50Hz & 208-230V ~60Hz					
Piping connection	Liquid pipe	mm	Φ6.35	Φ6.35	Φ6.35	Φ6.35	Φ6.35
	Gas pipe	mm	Φ9.52	Φ9.52	Φ9.52	Φ12.7	Φ12.7
Drain pipe	External diameter × Thickness	mm	Φ25×2.5	Φ25×2.5	Φ25×2.5	Φ25×2.5	Φ25×2.5
Outline dimensions (W×D×H)	mm	700×700×300	700×700×300	700×700×300	700×700×300	700×700×300	700×700×300
Net weight	kg	30.5	30.5	30.5	30.5	30.5	31.5

Model		GMV-ND45PHS/D-T	GMV-ND50PHS/D-T	GMV-ND56PHS/D-T	GMV-ND63PHS/D-T	GMV-ND71PHS/D-T	GMV-ND80PHS/D-T
Cooling capacity	kW	4.5	5.0	5.6	6.3	7.1	8.0
Heating capacity	kW	5.0	5.6	6.3	7.1	8.0	9.0
Air volume	m <sup>3</sup> /h	850	850	1000	1000	1250	1250
External Static	Pa	50/0~80	50/0~80	90/0~200	90/0~200	90/0~200	90/0~200

# DC INVERTER MULTI VRF INDOOR UNIT TECHNICAL SALES GUIDE

Model		GMV-ND45PHS/D-T	GMV-ND50PHS/D-T	GMV-ND56PHS/D-T	GMV-ND63PHS/D-T	GMV-ND71PHS/D-T	GMV-ND80PHS/D-T
Cooling power input	W	100	100	105	105	110	110
Cooling current input	A	0.8	0.8	0.8	0.8	0.9	0.9
Heating power input	W	100	100	105	105	110	110
Heating current input	A	0.8	0.8	0.8	0.8	0.9	0.9
Sound pressure level	dB(A)	40	40	40	40	40	40
Power supply		220-240V ~50Hz & 208-230V ~60Hz					
Piping connection	Liquid pipe	mm	Φ6.35	Φ6.35	Φ9.52	Φ9.52	Φ9.52
	Gas pipe	mm	Φ12.7	Φ12.7	Φ15.9	Φ15.9	Φ15.9
Drain pipe	External diameter × Thickness	mm	Φ25×2.5	Φ25×2.5	Φ25×2.5	Φ25×2.5	Φ25×2.5
Outline dimensions (W×D×H)		mm	700×700×300	700×700×300	1000×700×300	1000×700×300	1000×700×300
Net weight		kg	31.5	31.5	40.5	40.5	41

Model		GMV-ND90PHS/D-T	GMV-ND100PHS/D-T	GMV-ND112PHS/D-T	GMV-ND125PHS/D-T	GMV-ND140PHS/D-T	GMV-ND160PHS/D-T
Cooling capacity	kW	9.0	10.0	11.2	12.5	14.0	16.0
Heating capacity	kW	10.0	11.2	12.5	14.0	16.0	18.0
Air volume	m³/h	1800	1800	2000	2000	2350	2500
External Static	Pa	90/0~200	90/0~200	90/0~200	90/0~200	90/0~200	90/0~200
Cooling power input	W	170	170	170	170	240	240
Cooling current input	A	1.4	1.4	1.4	1.4	1.8	1.8
Heating power input	W	170	170	170	170	240	240
Heating current input	A	1.4	1.4	1.4	1.4	1.8	1.8
Sound pressure level	dB(A)	42	42	43	44	44	45
Power supply		220-240V ~50Hz & 208-230V ~60Hz					
Piping connection	Liquid pipe	mm	Φ9.52	Φ9.52	Φ9.52	Φ9.52	Φ9.52
	Gas pipe	mm	Φ15.9	Φ15.9	Φ15.9	Φ15.9	Φ19.05
Drain pipe	External diameter × Thickness	mm	Φ25×2.5	Φ25×2.5	Φ25×2.5	Φ25×2.5	Φ25×2.5
Outline dimensions (W×D×H)		mm	1400×700×300	1400×700×300	1400×700×300	1400×700×300	1400×700×300
Net weight		kg	54	54	54	54	54.5

Model		GMV-ND180PHS/D-T					
Cooling capacity	kW	18.0					
Heating capacity	kW	20.0					
External Static	Pa	90/0~170					
Air volume	m³/h	3000					
Cooling power input	W	350					
Cooling current input	A	2.0					
Heating power input	W	350					
Heating current input	A	2.0					
Minimum line current	A	3.39					
Maximum fuse current	A	6					
Sound pressure level	dB(A)	49					
Power supply		220-240V ~50Hz & 208-230V ~60Hz					

Model			GMV-ND180PHS/D-T
Piping connection	Liquid pipe	mm	Φ9.52
	Gas pipe	mm	Φ19.05
Drain pipe	External diameter × Thickness	mm	Φ25×2.5
Outline dimensions	W×D×H	mm	1400×700×300
Net weight		kg	58

## 2.20 Middle Static Pressure Duct Type Indoor Unit

Model			GMV-ND56PMS/A1-T	GMV-ND63PMS/A1-T	GMV-ND71PMS/A1-T	GMV-ND80PMS/A1-T	GMV-ND90PMS/A1-T
Cooling capacity	kW		5.6	6.3	7.1	8	9
Heating capacity	kW		6.3	7.1	8	9	10
Air volume	m³/h		1100/900/700	1100/900/700	1100/900/700	1100/900/700	1700/1500/1100
External Static	Pa		50/0~80	50/0~80	50/0~80	50/0~80	50/0~80
Cooling power input	W		95	95	95	100	120
Cooling current input	A		0.72	0.72	0.72	0.75	0.85
Heating power input	W		95	95	95	100	120
Heating current input	A		0.72	0.72	0.72	0.75	0.85
Sound pressure level	dB(A)		37/34/31	37/34/31	37/34/31	37/34/31	40/36/32
Power supply			220-240V ~50Hz & 208-230V ~60Hz				
Piping connection	Liquid pipe	mm	Φ9.52	Φ9.52	Φ9.52	Φ9.52	Φ9.52
	Gas pipe	mm	Φ15.9	Φ15.9	Φ15.9	Φ15.9	Φ15.9
Drain pipe	External diameter × Thickness	mm	Φ25×2.5	Φ25×2.5	Φ25×2.5	Φ25×2.5	Φ25×2.5
Outline dimensions	W×D×H	mm	900×655×260	900×655×260	900×655×260	900×655×260	1340×655×260
Net weight		kg	29.5	29.5	29.5	30.0	43.5

Model			GMV-ND100PMS/A1-T	GMV-ND112PMS/A1-T	GMV-ND125PMS/A1-T	GMV-ND140PMS/A1-T
Cooling capacity	kW		10	11.2	12.5	14
Heating capacity	kW		11.2	12.5	14	16
Air volume	m³/h		1700/1500/1100	1700/1500/1100	2000/1700/1400	2000/1700/1400
External Static	Pa		50/0~80	50/0~80	50/0~80	50/0~80
Cooling power input	W		120	120	170	170
Cooling current input	A		0.85	0.85	1.2	1.2
Heating power input	W		120	120	170	170
Heating current input	A		0.85	0.85	1.2	1.2
Sound pressure level	dB(A)		40/36/32	40/36/32	42/40/37	42/40/37
Power supply			220-240V ~50Hz & 208-230V ~60Hz			
Piping connection	Liquid pipe	mm	Φ9.52	Φ9.52	Φ9.52	Φ9.52
	Gas pipe	mm	Φ15.9	Φ15.9	Φ15.9	Φ15.9
Drain pipe	External diameter × Thickness	mm	Φ25×2.5	Φ25×2.5	Φ25×2.5	Φ25×2.5
Outline dimensions	W×D×H	mm	1340×655×260	1340×655×260	1340×655×260	1340×655×260
Net weight		kg	43.5	43.5	43.5	43.5

## 3 ELECTRICAL SPECIFICATIONS

### Circuit Breaker and Wire Diameter Selection of Indoor Unit

Selection of circuit breakers and power cables for connecting all the indoor units of the same system to the general power supply:

Total Current Capacity of Indoor Units	Circuit Breaker Capacity (A)	Minimum Sectional Area of Power Cable (mm <sup>2</sup> /AWG)	Minimum Sectional Area of Grounding Wire (mm <sup>2</sup> /AWG)
Less than 10A	10	1.0/AWG18	1.0/AWG18
16~10A	16	1.5/AWG16	1.5/AWG16
20~16A	20	2.5/AWG14	2.5/AWG14
32~20A	32	4.0/AWG10	4.0/AWG10
40~32A	40	6.0/AWG8	6.0/AWG8
50~40A	50	10.0/AWG8	10.0/AWG8
63~50A	63	16.0/AWG6	16.0/AWG6
80~63A	80	25.0/AWG4	16.0/AWG6
100~80A	100	35.0/AWG2	16.0/AWG6
125~100A	125	50.0/AWG1	25.0/AWG4

Selection of circuit breakers and power cables for separately installing each indoor unit:

### General static pressure Duct Type Indoor Unit

Model	Power Supply	Circuit Breaker Capacity (A)	Minimum Sectional Area of Ground Wire (mm <sup>2</sup> /AWG)	Minimum Sectional Area of Power Cord (mm <sup>2</sup> /AWG)
GMV-ND18PLS/C-T	220-240V ~50Hz & 208-230V ~60Hz	6	1.0/AWG18	1.0/AWG18
GMV-ND22PLS/C-T	220-240V ~50Hz & 208-230V ~60Hz	6	1.0/AWG18	1.0/AWG18
GMV-ND25PLS/C-T	220-240V ~50Hz & 208-230V ~60Hz	6	1.0/AWG18	1.0/AWG18
GMV-ND28PLS/C-T	220-240V ~50Hz & 208-230V ~60Hz	6	1.0/AWG18	1.0/AWG18
GMV-ND32PLS/C-T	220-240V ~50Hz & 208-230V ~60Hz	6	1.0/AWG18	1.0/AWG18
GMV-ND36PLS/C-T	220-240V ~50Hz & 208-230V ~60Hz	6	1.0/AWG18	1.0/AWG18
GMV-ND40PLS/C-T	220-240V ~50Hz & 208-230V ~60Hz	6	1.0/AWG18	1.0/AWG18
GMV-ND45PLS/C-T	220-240V ~50Hz & 208-230V ~60Hz	6	1.0/AWG18	1.0/AWG18
GMV-ND50PLS/C-T	220-240V ~50Hz & 208-230V ~60Hz	6	1.0/AWG18	1.0/AWG18
GMV-ND56PLS/C-T	220-240V ~50Hz & 208-230V ~60Hz	6	1.0/AWG18	1.0/AWG18
GMV-ND63PLS/C-T	220-240V ~50Hz & 208-230V ~60Hz	6	1.0/AWG18	1.0/AWG18
GMV-ND71PLS/C-T	220-240V ~50Hz & 208-230V ~60Hz	6	1.0/AWG18	1.0/AWG18
GMV-ND80PLS/C-T	220-240V ~50Hz & 208-230V ~60Hz	6	1.0/AWG18	1.0/AWG18
GMV-ND90PLS/C-T	220-240V ~50Hz & 208-230V ~60Hz	6	1.0/AWG18	1.0/AWG18
GMV-ND100PLS/C-T	220-240V ~50Hz & 208-230V ~60Hz	6	1.0/AWG18	1.0/AWG18
GMV-ND112PLS/C-T	220-240V ~50Hz & 208-230V ~60Hz	6	1.0/AWG18	1.0/AWG18
GMV-ND125PLS/C-T	220-240V ~50Hz & 208-230V ~60Hz	6	1.0/AWG18	1.0/AWG18
GMV-ND140PLS/C-T	220-240V ~50Hz & 208-230V ~60Hz	6	1.0/AWG18	1.0/AWG18
GMV-ND18PLS/C1-T	220-240V ~50Hz & 208-230V ~60Hz	6	1.0/AWG18	1.0/AWG18
GMV-ND22PLS/C1-T	220-240V ~50Hz & 208-230V ~60Hz	6	1.0/AWG18	1.0/AWG18
GMV-ND25PLS/C1-T	220-240V ~50Hz & 208-230V ~60Hz	6	1.0/AWG18	1.0/AWG18
GMV-ND28PLS/C1-T	220-240V ~50Hz & 208-230V ~60Hz	6	1.0/AWG18	1.0/AWG18
GMV-ND32PLS/C1-T	220-240V ~50Hz & 208-230V ~60Hz	6	1.0/AWG18	1.0/AWG18



Model	Power Supply	Circuit Breaker Capacity (A)	Minimum Sectional Area of Ground Wire (mm <sup>2</sup> /AWG)	Minimum Sectional Area of Power Cord (mm <sup>2</sup> /AWG)
GMV-ND36PLS/C1-T	220-240V ~50Hz & 208-230V ~60Hz	6	1.0/AWG18	1.0/AWG18
GMV-ND40PLS/C1-T	220-240V ~50Hz & 208-230V ~60Hz	6	1.0/AWG18	1.0/AWG18
GMV-ND45PLS/C1-T	220-240V ~50Hz & 208-230V ~60Hz	6	1.0/AWG18	1.0/AWG18
GMV-ND50PLS/C1-T	220-240V ~50Hz & 208-230V ~60Hz	6	1.0/AWG18	1.0/AWG18
GMV-ND56PLS/C1-T	220-240V ~50Hz & 208-230V ~60Hz	6	1.0/AWG18	1.0/AWG18
GMV-ND63PLS/C1-T	220-240V ~50Hz & 208-230V ~60Hz	6	1.0/AWG18	1.0/AWG18
GMV-ND71PLS/C1-T	220-240V ~50Hz & 208-230V ~60Hz	6	1.0/AWG18	1.0/AWG18
GMV-ND80PLS/C1-T	220-240V ~50Hz & 208-230V ~60Hz	6	1.0/AWG18	1.0/AWG18

#### Slim Duct Type

Model	Power Supply	Circuit Breaker Capacity (A)	Minimum Sectional Area of Ground Wire (mm <sup>2</sup> /AWG)	Minimum Sectional Area of Power Cord (mm <sup>2</sup> /AWG)
GMV-ND22PL/B-T	220-240V ~50Hz & 208-230V ~60Hz	6	1.0/AWG18	1.0/AWG18
GMV-ND25PL/B-T	220-240V ~50Hz & 208-230V ~60Hz	6	1.0/AWG18	1.0/AWG18
GMV-ND28PL/B-T	220-240V ~50Hz & 208-230V ~60Hz	6	1.0/AWG18	1.0/AWG18
GMV-ND32PL/B-T	220-240V ~50Hz & 208-230V ~60Hz	6	1.0/AWG18	1.0/AWG18
GMV-ND36PL/B-T	220-240V ~50Hz & 208-230V ~60Hz	6	1.0/AWG18	1.0/AWG18
GMV-ND40PL/B-T	220-240V ~50Hz & 208-230V ~60Hz	6	1.0/AWG18	1.0/AWG18
GMV-ND45PL/B-T	220-240V ~50Hz & 208-230V ~60Hz	6	1.0/AWG18	1.0/AWG18
GMV-ND50PL/B-T	220-240V ~50Hz & 208-230V ~60Hz	6	1.0/AWG18	1.0/AWG18
GMV-ND56PL/B-T	220-240V ~50Hz & 208-230V ~60Hz	6	1.0/AWG18	1.0/AWG18
GMV-ND63PL/B-T	220-240V ~50Hz & 208-230V ~60Hz	6	1.0/AWG18	1.0/AWG18
GMV-ND72PL/B-T	220-240V ~50Hz & 208-230V ~60Hz	6	1.0/AWG18	1.0/AWG18

#### Four-way Cassette Type

Model	Power Supply	Circuit Breaker Capacity (A)	Minimum Sectional Area of Ground Wire (mm <sup>2</sup> /AWG)	Minimum Sectional Area of Power Cord (mm <sup>2</sup> /AWG)
GMV-ND28T/A-T	220-240V ~50Hz & 208-230V ~60Hz	6	1.0/AWG18	1.0/AWG18
GMV-ND36T/A-T	220-240V ~50Hz & 208-230V ~60Hz	6	1.0/AWG18	1.0/AWG18
GMV-ND45T/A-T	220-240V ~50Hz & 208-230V ~60Hz	6	1.0/AWG18	1.0/AWG18
GMV-ND50T/A-T	220-240V ~50Hz & 208-230V ~60Hz	6	1.0/AWG18	1.0/AWG18
GMV-ND56T/A-T	220-240V ~50Hz & 208-230V ~60Hz	6	1.0/AWG18	1.0/AWG18
GMV-ND63T/A-T	220-240V ~50Hz & 208-230V ~60Hz	6	1.0/AWG18	1.0/AWG18

# DC INVERTER MULTI VRF INDOOR UNIT TECHNICAL SALES GUIDE

Model	Power Supply	Circuit Breaker Capacity (A)	Minimum Sectional Area of Ground Wire (mm <sup>2</sup> /AWG)	Minimum Sectional Area of Power Cord (mm <sup>2</sup> /AWG)
GMV-ND71T/A-T	220-240V ~50Hz & 208-230V ~60Hz	6	1.0/AWG18	1.0/AWG18
GMV-ND80T/A-T	220-240V ~50Hz & 208-230V ~60Hz	6	1.0/AWG18	1.0/AWG18
GMV-ND90T/A-T	220-240V ~50Hz & 208-230V ~60Hz	6	1.0/AWG18	1.0/AWG18
GMV-ND100T/A-T	220-240V ~50Hz & 208-230V ~60Hz	6	1.0/AWG18	1.0/AWG18
GMV-ND112T/A-T	220-240V ~50Hz & 208-230V ~60Hz	6	1.0/AWG18	1.0/AWG18
GMV-ND125T/A-T	220-240V ~50Hz & 208-230V ~60Hz	6	1.0/AWG18	1.0/AWG18
GMV-ND140T/A-T	220-240V ~50Hz & 208-230V ~60Hz	6	1.0/AWG18	1.0/AWG18
GMV-ND160T/A-T	220-240V ~50Hz & 208-230V ~60Hz	6	1.0/AWG18	1.0/AWG18

## One-way Cassette Type

Model	Power Supply	Circuit Breaker Capacity (A)	Minimum Sectional Area of Ground Wire (mm <sup>2</sup> /AWG)	Minimum Sectional Area of Power Cord (mm <sup>2</sup> /AWG)
GMV-ND22TD/A-T	220-240V ~50Hz & 208-230V ~60Hz	6	1.0/AWG18	1.0/AWG18
GMV-ND28TD/A-T	220-240V ~50Hz & 208-230V ~60Hz	6	1.0/AWG18	1.0/AWG18
GMV-ND36TD/A-T	220-240V ~50Hz & 208-230V ~60Hz	6	1.0/AWG18	1.0/AWG18
GMV-ND45TD/A-T	220-240V ~50Hz & 208-230V ~60Hz	6	1.0/AWG18	1.0/AWG18
GMV-ND50TD/A-T	220-240V ~50Hz & 208-230V ~60Hz	6	1.0/AWG18	1.0/AWG18
GMV-ND56TD/A-T	220-240V ~50Hz & 208-230V ~60Hz	6	1.0/AWG18	1.0/AWG18
GMV-ND63TD/B-T	220-240V ~50Hz & 208-230V ~60Hz	6	1.0/AWG18	1.0/AWG18
GMV-ND71TD/B-T	220-240V ~50Hz & 208-230V ~60Hz	6	1.0/AWG18	1.0/AWG18
GMV-ND80TD/B-T	220-240V ~50Hz & 208-230V ~60Hz	6	1.0/AWG18	1.0/AWG18

## Floor Ceiling Type

Model	Power Supply	Circuit Breaker Capacity (A)	Minimum Sectional Area of Ground Wire (mm <sup>2</sup> /AWG)	Minimum Sectional Area of Power Cord (mm <sup>2</sup> /AWG)
GMV-ND28ZD/A-T	220-240V ~50Hz & 208-230V ~60Hz	6	1.0/AWG18	1.0/AWG18
GMV-ND36ZD/A-T	220-240V ~50Hz & 208-230V ~60Hz	6	1.0/AWG18	1.0/AWG18
GMV-ND50ZD/A-T	220-240V ~50Hz & 208-230V ~60Hz	6	1.0/AWG18	1.0/AWG18
GMV-ND56ZD/A-T	220-240V ~50Hz & 208-230V ~60Hz	6	1.0/AWG18	1.0/AWG18
GMV-ND63ZD/A-T	220-240V ~50Hz & 208-230V ~60Hz	6	1.0/AWG18	1.0/AWG18
GMV-ND71ZD/A-T	220-240V ~50Hz & 208-230V ~60Hz	6	1.0/AWG18	1.0/AWG18

Model	Power Supply	Circuit Breaker Capacity (A)	Minimum Sectional Area of Ground Wire (mm <sup>2</sup> /AWG)	Minimum Sectional Area of Power Cord (mm <sup>2</sup> /AWG)
GMV-ND90ZD/A-T	220-240V ~50Hz & 208-230V ~60Hz	6	1.0/AWG18	1.0/AWG18
GMV-ND112ZD/A-T	220-240V ~50Hz & 208-230V ~60Hz	6	1.0/AWG18	1.0/AWG18
GMV-ND125ZD/A-T	220-240V ~50Hz & 208-230V ~60Hz	6	1.0/AWG18	1.0/AWG18
GMV-ND140ZD/A-T	220-240V ~50Hz & 208-230V ~60Hz	6	1.0/AWG18	1.0/AWG18
GMV-ND160ZD/A-T	220-240V ~50Hz & 208-230V ~60Hz	6	1.0/AWG18	1.0/AWG18
GMV-ND28ZD/B-T	220-240V ~50Hz & 208-230V ~60Hz	6	1.0/AWG18	1.0/AWG18
GMV-ND36ZD/B-T	220-240V ~50Hz & 208-230V ~60Hz	6	1.0/AWG18	1.0/AWG18
GMV-ND50ZD/B-T	220-240V ~50Hz & 208-230V ~60Hz	6	1.0/AWG18	1.0/AWG18
GMV-ND56ZD/B-T	220-240V ~50Hz & 208-230V ~60Hz	6	1.0/AWG18	1.0/AWG18
GMV-ND63ZD/B-T	220-240V ~50Hz & 208-230V ~60Hz	6	1.0/AWG18	1.0/AWG18
GMV-ND71ZD/B-T	220-240V ~50Hz & 208-230V ~60Hz	6	1.0/AWG18	1.0/AWG18
GMV-ND90ZD/B-T	220-240V ~50Hz & 208-230V ~60Hz	6	1.0/AWG18	1.0/AWG18
GMV-ND112ZD/B-T	220-240V ~50Hz & 208-230V ~60Hz	6	1.0/AWG18	1.0/AWG18
GMV-ND125ZD/B-T	220-240V ~50Hz & 208-230V ~60Hz	6	1.0/AWG18	1.0/AWG18
GMV-ND140ZD/B-T	220-240V ~50Hz & 208-230V ~60Hz	6	1.0/AWG18	1.0/AWG18
GMV-ND160ZD/B-T	220-240V ~50Hz & 208-230V ~60Hz	6	1.0/AWG18	1.0/AWG18

Wall Mounted Type

Model	Power Supply	Circuit Breaker Capacity (A)	Minimum Sectional Area of Ground Wire (mm <sup>2</sup> /AWG)	Minimum Sectional Area of Power Cord (mm <sup>2</sup> /AWG)
GMV-N22G/A3A-K GMV-N22G/A2A-K GMV-N22G/A4A-K GMV-N22G/A8A-K GMV-N22G/C9A-K GMV-N22G/E3A-K GMV-N22G/B3A-K	220-240V ~50Hz	6	1.0/AWG18	1.0/AWG18
GMV-N28G/A3A-K GMV-N28G/A2A-K GMV-N28G/A4A-K GMV-N28G/A8A-K GMV-N28G/C9A-K GMV-N28G/E3A-K GMV-N28G/B3A-K	220-240V ~50Hz	6	1.0/AWG18	1.0/AWG18
GMV-N36G/A3A-K GMV-N36G/A2A-K GMV-N36G/A4A-K GMV-N36G/A8A-K GMV-N36G/C9A-K GMV-N36G/E3A-K GMV-N36G/B3A-K	220-240V ~50Hz	6	1.0/AWG18	1.0/AWG18
GMV-N45G/A3A-K GMV-N45G/A2A-K GMV-N45G/A4A-K GMV-N45G/A8A-K GMV-N45G/C9A-K GMV-N45G/E3A-K GMV-N45G/B3A-K	220-240V ~50Hz	6	1.0/AWG18	1.0/AWG18
GMV-N50G/A3A-K GMV-N50G/A2A-K GMV-N50G/A4A-K GMV-N50G/A8A-K GMV-N50G/C9A-K GMV-N50G/E3A-K GMV-N50G/B3A-K	220-240V ~50Hz	6	1.0/AWG18	1.0/AWG18

# DC INVERTER MULTI VRF INDOOR UNIT TECHNICAL SALES GUIDE

Model	Power Supply	Circuit Breaker Capacity (A)	Minimum Sectional Area of Ground Wire (mm <sup>2</sup> /AWG)	Minimum Sectional Area of Power Cord (mm <sup>2</sup> /AWG)
GMV-N56G/A3A-K GMV-N56G/A2A-K GMV-N56G/A4A-K GMV-N56G/A8A-K GMV-N56G/C9A-K GMV-N56G/E3A-K GMV-N56G/B3A-K	220-240V ~50Hz	6	1.0/AWG18	1.0/AWG18
GMV-N63G/A3A-K GMV-N63G/A2A-K GMV-N63G/A4A-K GMV-N63G/A8A-K GMV-N63G/C9A-K GMV-N63G/E3A-K GMV-N63G/B3A-K	220-240V ~50Hz	6	1.0/AWG18	1.0/AWG18
GMV-N71G/A3A-K GMV-N71G/A2A-K GMV-N71G/A4A-K GMV-N71G/A8A-K GMV-N71G/C9A-K GMV-N71G/E3A-K GMV-N71G/B3A-K	220-240V ~50Hz	6	1.0/AWG18	1.0/AWG18
Model	Power Supply	Circuit Breaker Capacity (A)	Minimum Sectional Area of Ground Wire (mm <sup>2</sup> /AWG)	Minimum Sectional Area of Power Cord (mm <sup>2</sup> /AWG)
GMV-N22G/A3A-D GMV-N22G/A2A-D GMV-N22G/A4A-D GMV-N22G/A8A-D GMV-N22G/C9A-D GMV-N22G/E3A-D GMV-N22G/B3A-D	208-230V ~60Hz	6	1.0/AWG18	1.0/AWG18
GMV-N28G/A3A-D GMV-N28G/A2A-D GMV-N28G/A4A-D GMV-N28G/A8A-D GMV-N28G/C9A-D GMV-N28G/E3A-D GMV-N28G/B3A-D	208-230V ~60Hz	6	1.0/AWG18	1.0/AWG18
GMV-N36G/A3A-D GMV-N36G/A2A-D GMV-N36G/A4A-D GMV-N36G/A8A-D GMV-N36G/C9A-D GMV-N36G/E3A-D GMV-N36G/B3A-D	208-230V ~60Hz	6	1.0/AWG18	1.0/AWG18
GMV-N45G/A3A-D GMV-N45G/A2A-D GMV-N45G/A4A-D GMV-N45G/A8A-D GMV-N45G/C9A-D GMV-N45G/E3A-D GMV-N45G/B3A-D	208-230V ~60Hz	6	1.0/AWG18	1.0/AWG18
GMV-N50G/A3A-D GMV-N50G/A2A-D GMV-N50G/A4A-D GMV-N50G/A8A-D GMV-N50G/C9A-D GMV-N50G/E3A-D GMV-N50G/B3A-D	208-230V ~60Hz	6	1.0/AWG18	1.0/AWG18
GMV-N56G/A3A-D GMV-N56G/A2A-D GMV-N56G/A4A-D GMV-N56G/A8A-D GMV-N56G/C9A-D GMV-N56G/E3A-D GMV-N56G/B3A-D	208-230V ~60Hz	6	1.0/AWG18	1.0/AWG18
GMV-N63G/A3A-D GMV-N63G/A2A-D GMV-N63G/A4A-D GMV-N63G/A8A-D GMV-N63G/C9A-D GMV-N63G/E3A-D GMV-N63G/B3A-D	208-230V ~60Hz	6	1.0/AWG18	1.0/AWG18
GMV-N71G/A3A-D GMV-N71G/A2A-D GMV-N71G/A4A-D GMV-N71G/A8A-D GMV-N71G/C9A-D GMV-N71G/E3A-D GMV-N71G/B3A-D	208-230V ~60Hz	6	1.0/AWG18	1.0/AWG18
Model	Power Supply	Circuit Breaker Capacity (A)	Minimum Sectional Area of Ground Wire (mm <sup>2</sup> /AWG)	Minimum Sectional Area of Power Cord (mm <sup>2</sup> /AWG)
GMV-ND15G/B4B-T GMV-ND15G/B6B-T	220-240V~50Hz/208-230V~60Hz	6	1.0/AWG18	1.0/AWG18
GMV-ND18G/B4B-T GMV-ND18G/B6B-T	220-240V~50Hz/208-230V~60Hz	6	1.0/AWG18	1.0/AWG18
GMV-ND22G/A3A-T GMV-ND22G/A8A-T GMV-ND22G/B4B-T GMV-ND22G/B6B-T GMV-ND22G/C4B-T GMV-ND22G/C2B-T GMV-ND22G/D2B-T	220-240V~50Hz/ 208-230V~60Hz	6	1.0/AWG18	1.0/AWG18

Model	Power Supply	Circuit Breaker Capacity (A)	Minimum Sectional Area of Ground Wire (mm <sup>2</sup> /AWG)	Minimum Sectional Area of Power Cord (mm <sup>2</sup> /AWG)
GMV-ND28G/A3A-T GMV-ND28G/A8A-T GMV-ND28G/B4B-T GMV-ND28G/B6B-T GMV-ND28G/C4B-T GMV-ND28G/C2B-T GMV-ND28G/D2B-T	220-240V~50Hz/ 208-230V~60Hz	6	1.0/AWG18	1.0/AWG18
GMV-ND36G/A3A-T GMV-ND36G/A8A-T GMV-ND36G/B4B-T GMV-ND36G/B6B-T GMV-ND36G/C4B-T GMV-ND36G/C2B-T GMV-ND36G/D2B-T	220-240V~50Hz/ 208-230V~60Hz	6	1.0/AWG18	1.0/AWG18
GMV-ND45G/A3A-T GMV-ND45G/A8A-T GMV-ND45G/B4B-T GMV-ND45G/B6B-T GMV-ND45G/C4B-T GMV-ND45G/C2B-T GMV-ND45G/D2B-T	220-240V~50Hz/ 208-230V~60Hz	6	1.0/AWG18	1.0/AWG18
GMV-ND50G/A3A-T GMV-ND50G/A8A-T GMV-ND50G/B4B-T GMV-ND50G/B6B-T GMV-ND50G/C4B-T GMV-ND50G/C2B-T GMV-ND50G/D2B-T	220-240V~50Hz/ 208-230V~60Hz	6	1.0/AWG18	1.0/AWG18
GMV-ND56G/A3A-T GMV-ND56G/A8A-T GMV-ND56G/B4B-T GMV-ND56G/B6B-T GMV-ND56G/C4B-T GMV-ND56G/C2B-T GMV-ND56G/D2B-T	220-240V~50Hz/ 208-230V~60Hz	6	1.0/AWG18	1.0/AWG18
GMV-ND63G/A3A-T GMV-ND63G/A8A-T GMV-ND63G/B4B-T GMV-ND63G/B6B-T GMV-ND63G/C4B-T GMV-ND63G/C2B-T GMV-ND63G/D2B-T	220-240V~50Hz/ 208-230V~60Hz	6	1.0/AWG18	1.0/AWG18
GMV-ND71G/A3A-T GMV-ND71G/A8A-T GMV-ND71G/B4B-T GMV-ND71G/B6B-T GMV-ND71G/C4B-T GMV-ND71G/C2B-T GMV-ND71G/D2B-T	220-240V~50Hz/ 208-230V~60Hz	6	1.0/AWG18	1.0/AWG18
GMV-ND80G/A3A-T GMV-ND80G/A8A-T GMV-ND80G/B4B-T	220-240V~50Hz/ 208-230V~60Hz	6	1.0/AWG18	1.0/AWG18
GMV-ND90G/A3A-T GMV-ND90G/A8A-T GMV-ND90G/B4B-T	220-240V~50Hz/ 208-230V~60Hz	6	1.0/AWG18	1.0/AWG18
GMV-ND100G/A3A-T GMV-ND100G/A8A-T GMV-ND100G/B4B-T	220-240V~50Hz/ 208-230V~60Hz	6	1.0/AWG18	1.0/AWG18

# DC INVERTER MULTI VRF INDOOR UNIT TECHNICAL SALES GUIDE

## Fresh air Processing Unit

Model	Power Supply	Circuit Breaker Capacity (A)	Minimum Sectional Area of Ground Wire (mm <sup>2</sup> /AWG)	Minimum Sectional Area of Power Cord (mm <sup>2</sup> /AWG)
GMV-NX450P/A(X4.0)-M	380-415V 3N~ 50Hz	10	1.0/AWG18	1.0/AWG18
GMV-NDX125P/A-T	220-240V ~50Hz & 208-230V ~60Hz	6	1.0/AWG18	1.0/AWG18
GMV-NDX140P/A-T	220-240V ~50Hz & 208-230V ~60Hz	6	1.0/AWG18	1.0/AWG18
GMV-NDX224P/A-T	220-240V ~50Hz & 208-230V ~60Hz	10	1.0/AWG18	1.0/AWG18
GMV-NDX250P/A-T	220-240V ~50Hz & 208-230V ~60Hz	10	1.0/AWG18	1.0/AWG18
GMV-NDX280P/A-T	220-240V ~50Hz & 208-230V ~60Hz	10	1.0/AWG18	1.0/AWG18

## Console Type(Floor and Wall Mounted Type)

Model	Power Supply	Circuit Breaker Capacity (A)	Minimum Sectional Area of Ground Wire (mm <sup>2</sup> /AWG)	Minimum Sectional Area of Power Cord (mm <sup>2</sup> /AWG)
GMV-ND22C/A-T	220-240V~50Hz/ 208-230V~60Hz	6	1.0/AWG18	1.0/AWG18
GMV-ND28C/A-T	220-240V~50Hz/ 208-230V~60Hz	6	1.0/AWG18	1.0/AWG18
GMV-ND36C/A-T	220-240V~50Hz/ 208-230V~60Hz	6	1.0/AWG18	1.0/AWG18
GMV-ND45C/A-T	220-240V~50Hz/ 208-230V~60Hz	6	1.0/AWG18	1.0/AWG18
GMV-ND50C/A-T	220-240V~50Hz/ 208-230V~60Hz	6	1.0/AWG18	1.0/AWG18

## Floor Standing Type

Model	Power Supply	Circuit Breaker Capacity (A)	Minimum Sectional Area of Ground Wire (mm <sup>2</sup> /AWG)	Minimum Sectional Area of Power Cord (mm <sup>2</sup> /AWG)
GMV-ND100L/A-T	220-240V~50Hz/ 208-230V~60Hz	6	1.0/AWG18	1.0/AWG18
GMV-ND140L/A-T	220-240V~50Hz/ 208-230V~60Hz	6	1.0/AWG18	1.0/AWG18

## Compact Four-way Cassette Type

Model	Power Supply	Circuit Breaker Capacity (A)	Minimum Sectional Area of Ground Wire (mm <sup>2</sup> /AWG)	Minimum Sectional Area of Power Cord (mm <sup>2</sup> /AWG)
GMV-ND22T/B-T	220-240V ~50Hz & 208-230V ~60Hz	6	1.0/AWG18	1.0/AWG18
GMV-ND28T/B-T	220-240V ~50Hz & 208-230V ~60Hz	6	1.0/AWG18	1.0/AWG18
GMV-ND36T/B-T	220-240V ~50Hz & 208-230V ~60Hz	6	1.0/AWG18	1.0/AWG18
GMV-ND45T/B-T	220-240V ~50Hz & 208-230V ~60Hz	6	1.0/AWG18	1.0/AWG18
GMV-ND50T/B-T	220-240V ~50Hz & 208-230V ~60Hz	6	1.0/AWG18	1.0/AWG18
GMV-ND56T/B-T	220-240V ~50Hz & 208-230V ~60Hz	6	1.0/AWG18	1.0/AWG18

## 360° Air Discharge Compact Cassette Type

Model	Power Supply	Circuit Breaker Capacity (A)	Minimum Sectional Area of Grounding Wire(mm <sup>2</sup> /AWG)	Minimum Sectional Area of Power Cable (mm <sup>2</sup> /AWG)
GMV-ND15T/E-T	220-240V ~50Hz & 208-230V ~60Hz	6	1.0/AWG18	1.0/AWG18



Model	Power Supply	Circuit Breaker Capacity (A)	Minimum Sectional Area of Grounding Wire(mm <sup>2</sup> /AWG)	Minimum Sectional Area of Power Cable (mm <sup>2</sup> /AWG)
GMV-ND18T/E-T	220-240V ~50Hz & 208-230V ~60Hz	6	1.0/AWG18	1.0/AWG18
GMV-ND22T/E-T	220-240V ~50Hz & 208-230V ~60Hz	6	1.0/AWG18	1.0/AWG18
GMV-ND28T/E-T	220-240V ~50Hz & 208-230V ~60Hz	6	1.0/AWG18	1.0/AWG18
GMV-ND36T/E-T	220-240V ~50Hz & 208-230V ~60Hz	6	1.0/AWG18	1.0/AWG18
GMV-ND45T/E-T	220-240V ~50Hz & 208-230V ~60Hz	6	1.0/AWG18	1.0/AWG18
GMV-ND50T/E-T	220-240V ~50Hz & 208-230V ~60Hz	6	1.0/AWG18	1.0/AWG18
GMV-ND56T/E-T	220-240V ~50Hz & 208-230V ~60Hz	6	1.0/AWG18	1.0/AWG18

### 360° Air Discharge Cassette Type

Model	Power Supply	Circuit Breaker Capacity (A)	Minimum Sectional Area of Grounding Wire(mm <sup>2</sup> )	Minimum Sectional Area of Power Cable (mm <sup>2</sup> )
GMV-ND22~160T/C-T GMV-ND22~50T/C1-T GMV-ND22~140T/D1-T	220-240V ~50Hz & 208-230V ~60Hz	6	1.0/AWG18	1.0/AWG18

### AHU-KIT Type

Model	Power Supply	Circuit Breaker Capacity (A)	Minimum Sectional Area of Ground Wire (mm <sup>2</sup> /AWG)	Minimum Sectional Area of Power Cord (mm <sup>2</sup> /AWG)
GMV-N36U/C-T	220-240V ~50Hz & 208-230V ~60Hz	6	1.0/AWG18	1.0/AWG18
GMV-N71U/C-T	220-240V ~50Hz & 208-230V ~60Hz	6	1.0/AWG18	1.0/AWG18
GMV-N140U/C-T	220-240V ~50Hz & 208-230V ~60Hz	6	1.0/AWG18	1.0/AWG18
GMV-N280U/C-T	220-240V ~50Hz & 208-230V ~60Hz	6	1.0/AWG18	1.0/AWG18
GMV-N560U/C-T	220-240V ~50Hz & 208-230V ~60Hz	6	1.0/AWG18	1.0/AWG18

### Two-way Cassette Type

Model	Power Supply	Circuit Breaker Capacity (A)	Minimum Sectional Area of Ground Wire (mm <sup>2</sup> /AWG)	Minimum Sectional Area of Power Cord (mm <sup>2</sup> /AWG)
GMV-ND28TS/A-T	220-240V ~50Hz & 208-230V ~60Hz	6	1.0/AWG18	1.0/AWG18
GMV-ND36TS/A-T	220-240V ~50Hz & 208-230V ~60Hz	6	1.0/AWG18	1.0/AWG18
GMV-ND45TS/A-T	220-240V ~50Hz & 208-230V ~60Hz	6	1.0/AWG18	1.0/AWG18
GMV-ND50TS/A-T	220-240V ~50Hz & 208-230V ~60Hz	6	1.0/AWG18	1.0/AWG18
GMV-ND56TS/A-T	220-240V ~50Hz & 208-230V ~60Hz	6	1.0/AWG18	1.0/AWG18
GMV-ND63TS/A-T	220-240V ~50Hz & 208-230V ~60Hz	6	1.0/AWG18	1.0/AWG18
GMV-ND71TS/A-T	220-240V ~50Hz & 208-230V ~60Hz	6	1.0/AWG18	1.0/AWG18
GMV-ND28TS/B-T	220-240V ~50Hz & 208-230V ~60Hz	6	1.0/AWG18	1.0/AWG18
GMV-ND36TS/B-T	220-240V ~50Hz & 208-230V ~60Hz	6	1.0/AWG18	1.0/AWG18



# DC INVERTER MULTI VRF INDOOR UNIT TECHNICAL SALES GUIDE

Model	Power Supply	Circuit Breaker Capacity (A)	Minimum Sectional Area of Ground Wire (mm <sup>2</sup> /AWG)	Minimum Sectional Area of Power Cord (mm <sup>2</sup> /AWG)
GMV-ND45TS/B-T	220-240V ~50Hz & 208-230V ~60Hz	6	1.0/AWG18	1.0/AWG18
GMV-ND50TS/B-T	220-240V ~50Hz & 208-230V ~60Hz	6	1.0/AWG18	1.0/AWG18
GMV-ND56TS/B-T	220-240V ~50Hz & 208-230V ~60Hz	6	1.0/AWG18	1.0/AWG18
GMV-ND63TS/B-T	220-240V ~50Hz & 208-230V ~60Hz	6	1.0/AWG18	1.0/AWG18
GMV-ND71TS/B-T	220-240V ~50Hz & 208-230V ~60Hz	6	1.0/AWG18	1.0/AWG18
GMV-ND80TS/B-T	220-240V ~50Hz & 208-230V ~60Hz	6	1.0/AWG18	1.0/AWG18
GMV-ND90TS/B-T	220-240V ~50Hz & 208-230V ~60Hz	6	1.0/AWG18	1.0/AWG18
GMV-ND100TS/B-T	220-240V ~50Hz & 208-230V ~60Hz	6	1.0/AWG18	1.0/AWG18
GMV-ND112TS/B-T	220-240V ~50Hz & 208-230V ~60Hz	6	1.0/AWG18	1.0/AWG18
GMV-ND125TS/B-T	220-240V ~50Hz & 208-230V ~60Hz	6	1.0/AWG18	1.0/AWG18
GMV-ND140TS/B-T	220-240V ~50Hz & 208-230V ~60Hz	6	1.0/AWG18	1.0/AWG18
GMV-ND160TS/B-T	220-240V ~50Hz & 208-230V ~60Hz	6	1.0/AWG18	1.0/AWG18

## Air Handler type Indoor Unit

Model	Power Supply	Circuit Breaker Capacity (A)	Minimum Sectional Area of Ground Wire (mm <sup>2</sup> /AWG)	Minimum Sectional Area of Power Cord (mm <sup>2</sup> /AWG)
GMV-NR71A/A-D	208-230V~60Hz	6	1.0/AWG18	1.0/AWG18
GMV-NR90A/A-D	208-230V~60Hz	6	1.0/AWG18	1.0/AWG18
GMV-NR100A/A-D	208-230V~60Hz	6	1.0/AWG18	1.0/AWG18
GMV-NR112A/A-D	208-230V~60Hz	6	1.0/AWG18	1.0/AWG18
GMV-NR140A/A-D	208-230V~60Hz	6	1.0/AWG18	1.0/AWG18

## Super High Static Pressure Duct Type Indoor Unit

Model	Power Supply	Circuit Breaker Capacity (A)	Minimum Sectional Area of Ground Wire (mm <sup>2</sup> /AWG)	Minimum Sectional Area of Power Cord (mm <sup>2</sup> /AWG)
GMV-ND22PHS/B-T	220-240V ~50Hz & 208-230V ~60Hz	6	1.0/AWG18	1.0/AWG18
GMV-ND25PHS/B-T	220-240V ~50Hz & 208-230V ~60Hz	6	1.0/AWG18	1.0/AWG18
GMV-ND28PHS/B-T	220-240V ~50Hz & 208-230V ~60Hz	6	1.0/AWG18	1.0/AWG18
GMV-ND32PHS/B-T	220-240V ~50Hz & 208-230V ~60Hz	6	1.0/AWG18	1.0/AWG18
GMV-ND36PHS/B-T	220-240V ~50Hz & 208-230V ~60Hz	6	1.0/AWG18	1.0/AWG18
GMV-ND40PHS/B-T	220-240V ~50Hz & 208-230V ~60Hz	6	1.0/AWG18	1.0/AWG18
GMV-ND45PHS/B-T	220-240V ~50Hz & 208-230V ~60Hz	6	1.0/AWG18	1.0/AWG18
GMV-ND50PHS/B-T	220-240V ~50Hz & 208-230V ~60Hz	6	1.0/AWG18	1.0/AWG18
GMV-ND56PHS/B-T	220-240V ~50Hz & 208-230V ~60Hz	6	1.0/AWG18	1.0/AWG18
GMV-ND63PHS/B-T	220-240V ~50Hz & 208-230V ~60Hz	6	1.0/AWG18	1.0/AWG18

Model	Power Supply	Circuit Breaker Capacity (A)	Minimum Sectional Area of Ground Wire (mm <sup>2</sup> /AWG)	Minimum Sectional Area of Power Cord (mm <sup>2</sup> /AWG)
GMV-ND71PHS/B-T	220-240V ~50Hz & 208-230V ~60Hz	6	1.0/AWG18	1.0/AWG18
GMV-ND80PHS/B-T	220-240V ~50Hz & 208-230V ~60Hz	6	1.0/AWG18	1.0/AWG18
GMV-ND90PHS/B-T	220-240V ~50Hz & 208-230V ~60Hz	6	1.0/AWG18	1.0/AWG18
GMV-ND100PHS/B-T	220-240V ~50Hz & 208-230V ~60Hz	6	1.0/AWG18	1.0/AWG18
GMV-ND112PHS/B-T	220-240V ~50Hz & 208-230V ~60Hz	6	1.0/AWG18	1.0/AWG18
GMV-ND125PHS/B-T	220-240V ~50Hz & 208-230V ~60Hz	6	1.0/AWG18	1.0/AWG18
GMV-ND140PHS/B-T	220-240V ~50Hz & 208-230V ~60Hz	6	1.0/AWG18	1.0/AWG18
GMV-ND160PHS/B-T	220-240V ~50Hz & 208-230V ~60Hz	6	1.0/AWG18	1.0/AWG18
GMV-ND180PHS/B-T	220-240V ~50Hz & 208-230V ~60Hz	6	1.0/AWG18	1.0/AWG18
GMV-ND224PH/A-T	220-240V ~50Hz & 208-230V ~60Hz	10	1.0/AWG18	1.0/AWG18
GMV-ND280PH/A-T	220-240V ~50Hz & 208-230V ~60Hz	10	1.0/AWG18	1.0/AWG18
GMV-ND400PH/AR-X	380-415V 3N~50/60Hz	10	1.0/AWG18	1.0/AWG18
GMV-ND450PH/AR-X	380-415V 3N~50/60Hz	10	1.0/AWG18	1.0/AWG18
GMV-N560PH/AR-M	380V 3N~50Hz	10	1.0/AWG18	1.0/AWG18

#### Concealed Floor Standing Type

Model	Power Supply	Circuit Breaker Capacity (A)	Minimum Sectional Area of Ground Wire (mm <sup>2</sup> /AWG)	Minimum Sectional Area of Power Cord (mm <sup>2</sup> /AWG)
GMV-ND22ZA/A-T	220-240V ~50Hz & 208-230V ~60Hz	6	1.0/AWG18	1.0/AWG18
GMV-ND28ZA/A-T	220-240V ~50Hz & 208-230V ~60Hz	6	1.0/AWG18	1.0/AWG18
GMV-ND36ZA/A-T	220-240V ~50Hz & 208-230V ~60Hz	6	1.0/AWG18	1.0/AWG18
GMV-ND45ZA/A-T	220-240V ~50Hz & 208-230V ~60Hz	6	1.0/AWG18	1.0/AWG18
GMV-ND56ZA/A-T	220-240V ~50Hz & 208-230V ~60Hz	6	1.0/AWG18	1.0/AWG18
GMV-ND63ZA/A-T	220-240V ~50Hz & 208-230V ~60Hz	6	1.0/AWG18	1.0/AWG18
GMV-ND71ZA/A-T	220-240V ~50Hz & 208-230V ~60Hz	6	1.0/AWG18	1.0/AWG18

#### Heat Storage Module

Model	Power Supply	Circuit Breaker Capacity (A)	Minimum Sectional Area of Ground Wire (mm <sup>2</sup> /AWG)	Minimum Sectional Area of Power Cord (mm <sup>2</sup> /AWG)
XRZ180L/A-T	220-240V~50Hz/208-230V~60Hz	6	1.0/AWG18	1.0/AWG18

#### High Static Pressure Duct Type Indoor Unit

Model	Power Supply	Circuit Breaker Capacity (A)	Minimum Sectional Area of Ground Wire (mm <sup>2</sup> /AWG)	Minimum Sectional Area of Power Cord (mm <sup>2</sup> /AWG)
GMV-ND22PHS/D-T	220-240V ~50Hz & 208-230V ~60Hz	6	1.0/AWG18	1.0/AWG18
GMV-ND25PHS/D-T	220-240V ~50Hz & 208-230V ~60Hz	6	1.0/AWG18	1.0/AWG18
GMV-ND28PHS/D-T	220-240V ~50Hz & 208-230V ~60Hz	6	1.0/AWG18	1.0/AWG18

# DC INVERTER MULTI VRF INDOOR UNIT TECHNICAL SALES GUIDE

Model	Power Supply	Circuit Breaker Capacity (A)	Minimum Sectional Area of Ground Wire (mm <sup>2</sup> /AWG)	Minimum Sectional Area of Power Cord (mm <sup>2</sup> /AWG)
GMV-ND32PHS/D-T	220-240V ~50Hz & 208-230V ~60Hz	6	1.0/AWG18	1.0/AWG18
GMV-ND36PHS/D-T	220-240V ~50Hz & 208-230V ~60Hz	6	1.0/AWG18	1.0/AWG18
GMV-ND40PHS/D-T	220-240V ~50Hz & 208-230V ~60Hz	6	1.0/AWG18	1.0/AWG18
GMV-ND45PHS/D-T	220-240V ~50Hz & 208-230V ~60Hz	6	1.0/AWG18	1.0/AWG18
GMV-ND50PHS/D-T	220-240V ~50Hz & 208-230V ~60Hz	6	1.0/AWG18	1.0/AWG18
GMV-ND56PHS/D-T	220-240V ~50Hz & 208-230V ~60Hz	6	1.0/AWG18	1.0/AWG18
GMV-ND63PHS/D-T	220-240V ~50Hz & 208-230V ~60Hz	6	1.0/AWG18	1.0/AWG18
GMV-ND71PHS/D-T	220-240V ~50Hz & 208-230V ~60Hz	6	1.0/AWG18	1.0/AWG18
GMV-ND80PHS/D-T	220-240V ~50Hz & 208-230V ~60Hz	6	1.0/AWG18	1.0/AWG18
GMV-ND90PHS/D-T	220-240V ~50Hz & 208-230V ~60Hz	6	1.0/AWG18	1.0/AWG18
GMV-ND100PHS/D-T	220-240V ~50Hz & 208-230V ~60Hz	6	1.0/AWG18	1.0/AWG18
GMV-ND112PHS/D-T	220-240V ~50Hz & 208-230V ~60Hz	6	1.0/AWG18	1.0/AWG18
GMV-ND125PHS/D-T	220-240V ~50Hz & 208-230V ~60Hz	6	1.0/AWG18	1.0/AWG18
GMV-ND140PHS/D-T	220-240V ~50Hz & 208-230V ~60Hz	6	1.0/AWG18	1.0/AWG18
GMV-ND160PHS/D-T	220-240V ~50Hz & 208-230V ~60Hz	6	1.0/AWG18	1.0/AWG18
GMV-ND180PHS/D-T	220-240V ~50Hz & 208-230V ~60Hz	6	1.0/AWG18	1.0/AWG18

## Notes:

- ① The circuit breaker and power cable specifications in the above table are selected according to the maximum unit power (maximum current).
- ② The power cable specifications in the table are obtained under the condition that the multi-copper core cable (such as YJV copper-core XLPE insulated power cable ) is laid in the wire trough in an exposed manner (the ambient temperature is 40°C and the cable operating temperature is 90°C) (GB/T 16895.15). If the use condition is different, calculate and adjust the specification according to the corresponding applicable standard.
- ③ The circuit breaker specifications in the above table are obtained under the condition that the ambient temperature is 40°C when the circuit breaker is operating. If the use condition is different, calculate and adjust the specification according to the instructions on circuit breaker specifications.
- ④ A cut-off device is installed near the unit. The minimum space between levels of the cut-off device is 3 mm (it is required for both the indoor unit and outdoor unit).



# DC INVERTER MULTI VRF INDOOR UNIT TECHNICAL SALES GUIDE

Capacity Index	Outdoor temperature (°C DB)	Indoor temperature (°C WB/°C DB)													
		14.0°C WB		16.0°C WB		18.0°C WB		19.0°C WB		20.0°C WB		22.0°C WB		24.0°C WB	
		20°C DB		23°C DB		26°C DB		27°C DB		28°C DB		30°C DB		32°C DB	
		TC	SC	TC	SC	TC	SC	TC	SC	TC	SC	TC	SC	TC	SC
22	10.0	1.5	1.2	1.8	1.4	2.0	1.6	2.2	1.7	2.4	1.7	2.7	1.8	2.9	1.9
	12.0	1.5	1.2	1.8	1.4	2.0	1.6	2.2	1.7	2.4	1.7	2.7	1.8	2.9	1.9
	14.0	1.5	1.2	1.8	1.4	2.0	1.6	2.2	1.7	2.4	1.7	2.7	1.8	2.9	1.9
	16.0	1.5	1.2	1.8	1.4	2.0	1.6	2.2	1.7	2.4	1.7	2.7	1.8	2.9	1.9
	18.0	1.5	1.2	1.8	1.4	2.0	1.6	2.2	1.7	2.4	1.7	2.7	1.8	2.9	1.9
	20.0	1.5	1.2	1.8	1.4	2.0	1.6	2.2	1.7	2.4	1.7	2.7	1.8	2.9	1.9
	21.0	1.5	1.2	1.8	1.4	2.0	1.6	2.2	1.7	2.4	1.7	2.7	1.8	2.9	1.9
	23.0	1.5	1.2	1.8	1.4	2.0	1.6	2.2	1.7	2.4	1.7	2.7	1.8	2.8	1.9
	25.0	1.5	1.2	1.8	1.4	2.0	1.6	2.2	1.7	2.4	1.7	2.7	1.8	2.8	1.9
	27.0	1.5	1.2	1.8	1.4	2.0	1.6	2.2	1.7	2.4	1.7	2.6	1.8	2.8	1.8
	29.0	1.5	1.2	1.8	1.4	2.0	1.6	2.2	1.7	2.4	1.7	2.6	1.8	2.7	1.8
	31.0	1.5	1.2	1.8	1.4	2.0	1.6	2.2	1.7	2.4	1.7	2.6	1.8	2.7	1.8
	33.0	1.5	1.2	1.8	1.4	2.0	1.6	2.2	1.7	2.4	1.7	2.5	1.8	2.6	1.8
	35.0	1.5	1.2	1.8	1.4	2.0	1.6	2.2	1.7	2.4	1.7	2.5	1.8	2.6	1.8
	37.0	1.5	1.2	1.8	1.4	2.0	1.6	2.2	1.7	2.4	1.7	2.5	1.8	2.6	1.8
	39.0	1.5	1.2	1.8	1.4	2.0	1.6	2.2	1.7	2.4	1.7	2.4	1.8	2.5	1.7
40.0	1.5	1.2	1.8	1.4	2.0	1.6	2.2	1.7	2.3	1.7	2.4	1.8	2.5	1.7	
43.0	1.5	1.2	1.8	1.4	2.0	1.6	2.2	1.7	2.3	1.7	2.4	1.7	2.4	1.7	
25	10.0	1.8	1.3	2.0	1.6	2.3	1.8	2.5	1.9	2.7	1.9	3.1	2.0	3.4	2.2
	12.0	1.8	1.3	2.0	1.6	2.3	1.8	2.5	1.9	2.7	1.9	3.1	2.0	3.4	2.2
	14.0	1.8	1.3	2.0	1.6	2.3	1.8	2.5	1.9	2.7	1.9	3.1	2.0	3.4	2.2
	16.0	1.8	1.3	2.0	1.6	2.3	1.8	2.5	1.9	2.7	1.9	3.1	2.0	3.4	2.2
	18.0	1.8	1.3	2.0	1.6	2.3	1.8	2.5	1.9	2.7	1.9	3.1	2.0	3.4	2.2
	20.0	1.8	1.3	2.0	1.6	2.3	1.8	2.5	1.9	2.7	1.9	3.1	2.0	3.3	2.2
	21.0	1.8	1.3	2.0	1.6	2.3	1.8	2.5	1.9	2.7	1.9	3.1	2.0	3.3	2.1
	23.0	1.8	1.3	2.0	1.6	2.3	1.8	2.5	1.9	2.7	1.9	3.1	2.0	3.2	2.1
	25.0	1.8	1.3	2.0	1.6	2.3	1.8	2.5	1.9	2.7	1.9	3.0	2.0	3.2	2.1
	27.0	1.8	1.3	2.0	1.6	2.3	1.8	2.5	1.9	2.7	1.9	3.0	2.0	3.1	2.1
	29.0	1.8	1.3	2.0	1.6	2.3	1.8	2.5	1.9	2.7	1.9	2.9	2.0	3.1	2.1
	31.0	1.8	1.3	2.0	1.6	2.3	1.8	2.5	1.9	2.7	1.9	2.9	2.0	3.0	2.1
	33.0	1.8	1.3	2.0	1.6	2.3	1.8	2.5	1.9	2.7	1.9	2.9	2.0	3.0	2.0
	35.0	1.8	1.3	2.0	1.6	2.3	1.8	2.5	1.9	2.7	1.9	2.9	2.0	3.0	2.0
	37.0	1.8	1.3	2.0	1.6	2.3	1.8	2.5	1.9	2.7	2.0	2.8	2.0	2.9	2.0
	39.0	1.8	1.3	2.0	1.6	2.3	1.8	2.5	1.9	2.7	2.0	2.8	2.0	2.9	2.0
40.0	1.8	1.3	2.0	1.6	2.3	1.8	2.5	1.9	2.6	1.9	2.7	2.0	2.8	2.0	
43.0	1.8	1.3	2.0	1.6	2.3	1.8	2.5	1.9	2.6	1.9	2.7	2.0	2.8	1.9	

Capacity Index	Outdoor temperature (°C DB)	Indoor temperature (°C WB/°C DB)													
		14.0°C WB		16.0°C WB		18.0°C WB		19.0°C WB		20.0°C WB		22.0°C WB		24.0°C WB	
		20°C DB		23°C DB		26°C DB		27°C DB		28°C DB		30°C DB		32°C DB	
		TC	SC	TC	SC	TC	SC	TC	SC	TC	SC	TC	SC	TC	SC
28	10.0	2.0	1.5	2.3	1.8	2.6	2.1	2.8	2.1	3.0	2.1	3.4	2.2	3.8	2.4
	12.0	2.0	1.5	2.3	1.8	2.6	2.1	2.8	2.1	3.0	2.1	3.4	2.2	3.8	2.4
	14.0	2.0	1.5	2.3	1.8	2.6	2.1	2.8	2.1	3.0	2.1	3.4	2.2	3.8	2.4
	16.0	2.0	1.5	2.3	1.8	2.6	2.1	2.8	2.1	3.0	2.1	3.4	2.2	3.8	2.4
	18.0	2.0	1.5	2.3	1.8	2.6	2.1	2.8	2.1	3.0	2.1	3.4	2.2	3.8	2.4
	20.0	2.0	1.5	2.3	1.8	2.6	2.1	2.8	2.1	3.0	2.1	3.4	2.2	3.7	2.5
	21.0	2.0	1.5	2.3	1.8	2.6	2.1	2.8	2.1	3.0	2.1	3.4	2.2	3.6	2.4
	23.0	2.0	1.5	2.3	1.8	2.6	2.1	2.8	2.1	3.0	2.1	3.4	2.2	3.6	2.4
	25.0	2.0	1.5	2.3	1.8	2.6	2.1	2.8	2.1	3.0	2.1	3.4	2.3	3.5	2.4
	27.0	2.0	1.5	2.3	1.8	2.6	2.1	2.8	2.1	3.0	2.1	3.3	2.3	3.5	2.3
	29.0	2.0	1.5	2.3	1.8	2.6	2.1	2.8	2.1	3.0	2.1	3.3	2.3	3.4	2.3
	31.0	2.0	1.5	2.3	1.8	2.6	2.1	2.8	2.1	3.0	2.1	3.2	2.3	3.4	2.3
	33.0	2.0	1.5	2.3	1.8	2.6	2.1	2.8	2.1	3.0	2.1	3.2	2.3	3.3	2.3
	35.0	2.0	1.5	2.3	1.8	2.6	2.1	2.8	2.1	3.0	2.1	3.2	2.3	3.3	2.3
	37.0	2.0	1.5	2.3	1.8	2.6	2.1	2.8	2.1	3.0	2.2	3.1	2.3	3.2	2.2
	39.0	2.0	1.5	2.3	1.8	2.6	2.1	2.8	2.1	3.0	2.2	3.1	2.2	3.2	2.2
40.0	2.0	1.5	2.3	1.8	2.6	2.1	2.8	2.1	2.9	2.2	3.1	2.2	3.1	2.2	
43.0	2.0	1.5	2.3	1.8	2.6	2.1	2.8	2.1	2.9	2.1	3.0	2.2	3.1	2.2	
32	10.0	2.2	1.7	2.6	2.0	2.9	2.4	3.2	2.4	3.5	2.5	3.9	2.6	4.3	2.8
	12.0	2.2	1.7	2.6	2.0	2.9	2.4	3.2	2.4	3.5	2.5	3.9	2.6	4.3	2.8
	14.0	2.2	1.7	2.6	2.0	2.9	2.4	3.2	2.4	3.5	2.5	3.9	2.6	4.3	2.8
	16.0	2.2	1.7	2.6	2.0	2.9	2.4	3.2	2.4	3.5	2.5	3.9	2.6	4.3	2.8
	18.0	2.2	1.7	2.6	2.0	2.9	2.4	3.2	2.4	3.5	2.5	3.9	2.6	4.3	2.8
	20.0	2.2	1.7	2.6	2.0	2.9	2.4	3.2	2.4	3.5	2.5	3.9	2.6	4.3	2.8
	21.0	2.2	1.7	2.6	2.0	2.9	2.4	3.2	2.4	3.5	2.5	3.9	2.6	4.2	2.7
	23.0	2.2	1.7	2.6	2.0	2.9	2.4	3.2	2.4	3.5	2.5	3.9	2.6	4.1	2.7
	25.0	2.2	1.7	2.6	2.0	2.9	2.4	3.2	2.4	3.5	2.5	3.9	2.6	4.0	2.7
	27.0	2.2	1.7	2.6	2.0	2.9	2.4	3.2	2.4	3.5	2.5	3.8	2.6	4.0	2.7
	29.0	2.2	1.7	2.6	2.0	2.9	2.4	3.2	2.4	3.5	2.5	3.7	2.6	3.9	2.7
	31.0	2.2	1.7	2.6	2.0	2.9	2.4	3.2	2.4	3.5	2.5	3.7	2.6	3.9	2.6
	33.0	2.2	1.7	2.6	2.0	2.9	2.4	3.2	2.4	3.5	2.5	3.7	2.6	3.8	2.6
	35.0	2.2	1.7	2.6	2.0	2.9	2.4	3.2	2.4	3.5	2.5	3.6	2.6	3.8	2.6
	37.0	2.2	1.7	2.6	2.0	2.9	2.4	3.2	2.4	3.5	2.5	3.6	2.6	3.7	2.6
	39.0	2.2	1.7	2.6	2.0	2.9	2.4	3.2	2.4	3.4	2.5	3.5	2.6	3.6	2.5
40.0	2.2	1.7	2.6	2.0	2.9	2.4	3.2	2.4	3.4	2.5	3.5	2.5	3.6	2.5	
43.0	2.2	1.7	2.6	2.0	2.9	2.4	3.2	2.4	3.3	2.4	3.5	2.5	3.5	2.5	

# DC INVERTER MULTI VRF INDOOR UNIT TECHNICAL SALES GUIDE

Capacity Index	Outdoor temperature (°C DB)	Indoor temperature (°C WB/°C DB)													
		14.0°C WB		16.0°C WB		18.0°C WB		19.0°C WB		20.0°C WB		22.0°C WB		24.0°C WB	
		20°C DB		23°C DB		26°C DB		27°C DB		28°C DB		30°C DB		32°C DB	
		TC	SC	TC	SC	TC	SC	TC	SC	TC	SC	TC	SC	TC	SC
36	10.0	2.5	1.9	2.9	2.3	3.3	2.6	3.6	2.7	3.9	2.8	4.4	2.9	4.8	3.1
	12.0	2.5	1.9	2.9	2.3	3.3	2.6	3.6	2.7	3.9	2.8	4.4	2.9	4.8	3.1
	14.0	2.5	1.9	2.9	2.3	3.3	2.6	3.6	2.7	3.9	2.8	4.4	2.9	4.8	3.1
	16.0	2.5	1.9	2.9	2.3	3.3	2.6	3.6	2.7	3.9	2.8	4.4	2.9	4.8	3.1
	18.0	2.5	1.9	2.9	2.3	3.3	2.6	3.6	2.7	3.9	2.8	4.4	2.9	4.8	3.1
	20.0	2.5	1.9	2.9	2.3	3.3	2.6	3.6	2.7	3.9	2.8	4.4	2.9	4.8	3.2
	21.0	2.5	1.9	2.9	2.3	3.3	2.6	3.6	2.7	3.9	2.8	4.4	2.9	4.7	3.1
	23.0	2.5	1.9	2.9	2.3	3.3	2.6	3.6	2.7	3.9	2.8	4.4	2.9	4.6	3.0
	25.0	2.5	1.9	2.9	2.3	3.3	2.6	3.6	2.7	3.9	2.8	4.4	2.9	4.5	3.0
	27.0	2.5	1.9	2.9	2.3	3.3	2.6	3.6	2.7	3.9	2.8	4.3	2.9	4.5	3.0
	29.0	2.5	1.9	2.9	2.3	3.3	2.6	3.6	2.7	3.9	2.8	4.2	2.9	4.4	3.0
	31.0	2.5	1.9	2.9	2.3	3.3	2.6	3.6	2.7	3.9	2.8	4.2	2.9	4.4	3.0
	33.0	2.5	1.9	2.9	2.3	3.3	2.6	3.6	2.7	3.9	2.8	4.1	2.9	4.3	2.9
	35.0	2.5	1.9	2.9	2.3	3.3	2.6	3.6	2.7	3.9	2.8	4.1	2.9	4.2	2.9
	37.0	2.5	1.9	2.9	2.3	3.3	2.6	3.6	2.7	3.9	2.8	4.0	2.9	4.2	2.9
	39.0	2.5	1.9	2.9	2.3	3.3	2.6	3.6	2.7	3.9	2.8	4.0	2.9	4.1	2.8
40.0	2.5	1.9	2.9	2.3	3.3	2.6	3.6	2.7	3.8	2.8	3.9	2.9	4.0	2.8	
43.0	2.5	1.9	2.9	2.3	3.3	2.6	3.6	2.7	3.7	2.7	3.9	2.8	4.0	2.8	
40	10.0	2.8	2.1	3.2	2.5	3.7	2.9	4.0	3.0	4.3	3.1	4.9	3.2	5.4	3.5
	12.0	2.8	2.1	3.2	2.5	3.7	2.9	4.0	3.0	4.3	3.1	4.9	3.2	5.4	3.5
	14.0	2.8	2.1	3.2	2.5	3.7	2.9	4.0	3.0	4.3	3.1	4.9	3.2	5.4	3.5
	16.0	2.8	2.1	3.2	2.5	3.7	2.9	4.0	3.0	4.3	3.1	4.9	3.2	5.4	3.5
	18.0	2.8	2.1	3.2	2.5	3.7	2.9	4.0	3.0	4.3	3.1	4.9	3.2	5.4	3.5
	20.0	2.8	2.1	3.2	2.5	3.7	2.9	4.0	3.0	4.3	3.1	4.9	3.2	5.3	3.5
	21.0	2.8	2.1	3.2	2.5	3.7	2.9	4.0	3.0	4.3	3.1	4.9	3.2	5.2	3.4
	23.0	2.8	2.1	3.2	2.5	3.7	2.9	4.0	3.0	4.3	3.1	4.9	3.2	5.1	3.4
	25.0	2.8	2.1	3.2	2.5	3.7	2.9	4.0	3.0	4.3	3.1	4.8	3.2	5.0	3.4
	27.0	2.8	2.1	3.2	2.5	3.7	2.9	4.0	3.0	4.3	3.1	4.8	3.2	5.0	3.4
	29.0	2.8	2.1	3.2	2.5	3.7	2.9	4.0	3.0	4.3	3.1	4.7	3.2	4.9	3.3
	31.0	2.8	2.1	3.2	2.5	3.7	2.9	4.0	3.0	4.3	3.1	4.6	3.2	4.8	3.3
	33.0	2.8	2.1	3.2	2.5	3.7	2.9	4.0	3.0	4.3	3.1	4.6	3.2	4.8	3.2
	35.0	2.8	2.1	3.2	2.5	3.7	2.9	4.0	3.0	4.3	3.1	4.6	3.2	4.7	3.3
	37.0	2.8	2.1	3.2	2.5	3.7	2.9	4.0	3.0	4.3	3.2	4.5	3.2	4.6	3.2
	39.0	2.8	2.1	3.2	2.5	3.7	2.9	4.0	3.0	4.3	3.1	4.4	3.2	4.6	3.1
40.0	2.8	2.1	3.2	2.5	3.7	2.9	4.0	3.0	4.2	3.1	4.4	3.2	4.5	3.1	
43.0	2.8	2.1	3.2	2.5	3.7	2.9	4.0	3.0	4.1	3.0	4.3	3.2	4.4	3.1	



Capacity Index	Outdoor temperature (°C DB)	Indoor temperature (°C WB/°C DB)													
		14.0°C WB		16.0°C WB		18.0°C WB		19.0°C WB		20.0°C WB		22.0°C WB		24.0°C WB	
		20°C DB		23°C DB		26°C DB		27°C DB		28°C DB		30°C DB		32°C DB	
		TC	SC	TC	SC	TC	SC	TC	SC	TC	SC	TC	SC	TC	SC
45	10.0	3.2	2.4	3.6	2.8	4.1	3.3	4.5	3.4	4.9	3.5	5.5	3.6	6.0	3.9
	12.0	3.2	2.4	3.6	2.8	4.1	3.3	4.5	3.4	4.9	3.5	5.5	3.6	6.0	3.9
	14.0	3.2	2.4	3.6	2.8	4.1	3.3	4.5	3.4	4.9	3.5	5.5	3.6	6.0	3.9
	16.0	3.2	2.4	3.6	2.8	4.1	3.3	4.5	3.4	4.9	3.5	5.5	3.6	6.0	3.9
	18.0	3.2	2.4	3.6	2.8	4.1	3.3	4.5	3.4	4.9	3.5	5.5	3.6	6.0	3.9
	20.0	3.2	2.4	3.6	2.8	4.1	3.3	4.5	3.4	4.9	3.5	5.5	3.6	6.0	4.0
	21.0	3.2	2.4	3.6	2.8	4.1	3.3	4.5	3.4	4.9	3.5	5.5	3.6	5.9	3.9
	23.0	3.2	2.4	3.6	2.8	4.1	3.3	4.5	3.4	4.9	3.5	5.5	3.6	5.8	3.8
	25.0	3.2	2.4	3.6	2.8	4.1	3.3	4.5	3.4	4.9	3.5	5.4	3.6	5.7	3.8
	27.0	3.2	2.4	3.6	2.8	4.1	3.3	4.5	3.4	4.9	3.5	5.3	3.6	5.6	3.8
	29.0	3.2	2.4	3.6	2.8	4.1	3.3	4.5	3.4	4.9	3.5	5.3	3.6	5.5	3.8
	31.0	3.2	2.4	3.6	2.8	4.1	3.3	4.5	3.4	4.9	3.5	5.2	3.7	5.4	3.7
	33.0	3.2	2.4	3.6	2.8	4.1	3.3	4.5	3.4	4.9	3.5	5.2	3.6	5.4	3.6
	35.0	3.2	2.4	3.6	2.8	4.1	3.3	4.5	3.4	4.9	3.5	5.1	3.6	5.3	3.7
	37.0	3.2	2.4	3.6	2.8	4.1	3.3	4.5	3.4	4.9	3.5	5.0	3.6	5.2	3.6
	39.0	3.2	2.4	3.6	2.8	4.1	3.3	4.5	3.4	4.8	3.5	5.0	3.6	5.1	3.5
40.0	3.2	2.4	3.6	2.8	4.1	3.3	4.5	3.4	4.7	3.5	4.9	3.6	5.0	3.5	
43.0	3.2	2.4	3.6	2.8	4.1	3.3	4.5	3.4	4.6	3.4	4.9	3.5	5.0	3.5	
50	10.0	3.5	2.7	4.1	3.2	4.6	3.7	5.0	3.8	5.4	3.8	6.2	4.0	6.7	4.4
	12.0	3.5	2.7	4.1	3.2	4.6	3.7	5.0	3.8	5.4	3.8	6.2	4.0	6.7	4.4
	14.0	3.5	2.7	4.1	3.2	4.6	3.7	5.0	3.8	5.4	3.8	6.2	4.0	6.7	4.4
	16.0	3.5	2.7	4.1	3.2	4.6	3.7	5.0	3.8	5.4	3.8	6.2	4.0	6.7	4.4
	18.0	3.5	2.7	4.1	3.2	4.6	3.7	5.0	3.8	5.4	3.8	6.2	4.0	6.7	4.4
	20.0	3.5	2.7	4.1	3.2	4.6	3.7	5.0	3.8	5.4	3.8	6.2	4.0	6.7	4.4
	21.0	3.5	2.7	4.1	3.2	4.6	3.7	5.0	3.8	5.4	3.8	6.2	4.0	6.5	4.3
	23.0	3.5	2.7	4.1	3.2	4.6	3.7	5.0	3.8	5.4	3.8	6.2	4.0	6.4	4.2
	25.0	3.5	2.7	4.1	3.2	4.6	3.7	5.0	3.8	5.4	3.8	6.1	4.1	6.3	4.2
	27.0	3.5	2.7	4.1	3.2	4.6	3.7	5.0	3.8	5.4	3.8	5.9	4.0	6.3	4.2
	29.0	3.5	2.7	4.1	3.2	4.6	3.7	5.0	3.8	5.4	3.8	5.9	4.0	6.2	4.2
	31.0	3.5	2.7	4.1	3.2	4.6	3.7	5.0	3.8	5.4	3.8	5.8	4.1	6.1	4.1
	33.0	3.5	2.7	4.1	3.2	4.6	3.7	5.0	3.8	5.4	3.8	5.8	4.0	6.0	4.0
	35.0	3.5	2.7	4.1	3.2	4.6	3.7	5.0	3.8	5.4	3.8	5.7	4.0	5.9	4.1
	37.0	3.5	2.7	4.1	3.2	4.6	3.7	5.0	3.8	5.4	3.9	5.6	4.0	5.8	4.0
	39.0	3.5	2.7	4.1	3.2	4.6	3.7	5.0	3.8	5.4	3.9	5.5	4.0	5.7	3.9
40.0	3.5	2.7	4.1	3.2	4.6	3.7	5.0	3.8	5.3	3.9	5.5	4.0	5.6	3.9	
43.0	3.5	2.7	4.1	3.2	4.6	3.7	5.0	3.8	5.2	3.8	5.4	3.9	5.5	3.9	

# DC INVERTER MULTI VRF INDOOR UNIT TECHNICAL SALES GUIDE

Capacity Index	Outdoor temperature (°C DB)	Indoor temperature (°C WB/°C DB)													
		14.0°C WB		16.0°C WB		18.0°C WB		19.0°C WB		20.0°C WB		22.0°C WB		24.0°C WB	
		20°C DB		23°C DB		26°C DB		27°C DB		28°C DB		30°C DB		32°C DB	
		TC	SC	TC	SC	TC	SC	TC	SC	TC	SC	TC	SC	TC	SC
56	10.0	3.9	3.0	4.5	3.5	5.2	4.1	5.6	4.2	6.0	4.3	6.9	4.5	7.5	4.9
	12.0	3.9	3.0	4.5	3.5	5.2	4.1	5.6	4.2	6.0	4.3	6.9	4.5	7.5	4.9
	14.0	3.9	3.0	4.5	3.5	5.2	4.1	5.6	4.2	6.0	4.3	6.9	4.5	7.5	4.9
	16.0	3.9	3.0	4.5	3.5	5.2	4.1	5.6	4.2	6.0	4.3	6.9	4.5	7.5	4.9
	18.0	3.9	3.0	4.5	3.5	5.2	4.1	5.6	4.2	6.0	4.3	6.9	4.5	7.5	4.9
	20.0	3.9	3.0	4.5	3.5	5.2	4.1	5.6	4.2	6.0	4.3	6.9	4.5	7.4	4.9
	21.0	3.9	3.0	4.5	3.5	5.2	4.1	5.6	4.2	6.0	4.3	6.9	4.5	7.3	4.8
	23.0	3.9	3.0	4.5	3.5	5.2	4.1	5.6	4.2	6.0	4.3	6.9	4.5	7.2	4.7
	25.0	3.9	3.0	4.5	3.5	5.2	4.1	5.6	4.2	6.0	4.3	6.8	4.5	7.1	4.7
	27.0	3.9	3.0	4.5	3.5	5.2	4.1	5.6	4.2	6.0	4.3	6.7	4.5	7.0	4.7
	29.0	3.9	3.0	4.5	3.5	5.2	4.1	5.6	4.2	6.0	4.3	6.6	4.5	6.9	4.7
	31.0	3.9	3.0	4.5	3.5	5.2	4.1	5.6	4.2	6.0	4.3	6.5	4.5	6.8	4.6
	33.0	3.9	3.0	4.5	3.5	5.2	4.1	5.6	4.2	6.0	4.3	6.4	4.5	6.7	4.5
	35.0	3.9	3.0	4.5	3.5	5.2	4.1	5.6	4.2	6.0	4.3	6.4	4.5	6.6	4.6
	37.0	3.9	3.0	4.5	3.5	5.2	4.1	5.6	4.2	6.0	4.4	6.3	4.5	6.5	4.5
	39.0	3.9	3.0	4.5	3.5	5.2	4.1	5.6	4.2	6.0	4.4	6.2	4.5	6.4	4.4
40.0	3.9	3.0	4.5	3.5	5.2	4.1	5.6	4.2	5.9	4.4	6.1	4.5	6.3	4.4	
43.0	3.9	3.0	4.5	3.5	5.2	4.1	5.6	4.2	5.8	4.3	6.0	4.4	6.2	4.3	
63	10.0	4.4	3.4	5.1	4.0	5.8	4.6	6.3	4.7	6.8	4.8	7.7	5.0	8.4	5.5
	12.0	4.4	3.4	5.1	4.0	5.8	4.6	6.3	4.7	6.8	4.8	7.7	5.0	8.4	5.5
	14.0	4.4	3.4	5.1	4.0	5.8	4.6	6.3	4.7	6.8	4.8	7.7	5.0	8.4	5.5
	16.0	4.4	3.4	5.1	4.0	5.8	4.6	6.3	4.7	6.8	4.8	7.7	5.0	8.4	5.5
	18.0	4.4	3.4	5.1	4.0	5.8	4.6	6.3	4.7	6.8	4.8	7.7	5.0	8.4	5.5
	20.0	4.4	3.4	5.1	4.0	5.8	4.6	6.3	4.7	6.8	4.8	7.7	5.0	8.4	5.5
	21.0	4.4	3.4	5.1	4.0	5.8	4.6	6.3	4.7	6.8	4.8	7.7	5.0	8.2	5.4
	23.0	4.4	3.4	5.1	4.0	5.8	4.6	6.3	4.7	6.8	4.8	7.7	5.0	8.1	5.3
	25.0	4.4	3.4	5.1	4.0	5.8	4.6	6.3	4.7	6.8	4.8	7.6	5.1	7.9	5.3
	27.0	4.4	3.4	5.1	4.0	5.8	4.6	6.3	4.7	6.8	4.8	7.5	5.1	7.9	5.3
	29.0	4.4	3.4	5.1	4.0	5.8	4.6	6.3	4.7	6.8	4.8	7.4	5.1	7.7	5.3
	31.0	4.4	3.4	5.1	4.0	5.8	4.6	6.3	4.7	6.8	4.8	7.3	5.1	7.6	5.2
	33.0	4.4	3.4	5.1	4.0	5.8	4.6	6.3	4.7	6.8	4.8	7.2	5.1	7.5	5.1
	35.0	4.4	3.4	5.1	4.0	5.8	4.6	6.3	4.7	6.8	4.8	7.2	5.1	7.4	5.1
	37.0	4.4	3.4	5.1	4.0	5.8	4.6	6.3	4.7	6.8	5.0	7.1	5.1	7.3	5.0
	39.0	4.4	3.4	5.1	4.0	5.8	4.6	6.3	4.7	6.7	4.9	6.9	5.1	7.2	5.0
40.0	4.4	3.4	5.1	4.0	5.8	4.6	6.3	4.7	6.6	4.9	6.9	5.0	7.1	4.9	
43.0	4.4	3.4	5.1	4.0	5.8	4.6	6.3	4.7	6.5	4.8	6.8	5.0	6.9	4.9	

Capacity Index	Outdoor temperature (°C DB)	Indoor temperature (°C WB/°C DB)													
		14.0°C WB		16.0°C WB		18.0°C WB		19.0°C WB		20.0°C WB		22.0°C WB		24.0°C WB	
		20°C DB		23°C DB		26°C DB		27°C DB		28°C DB		30°C DB		32°C DB	
		TC	SC	TC	SC	TC	SC	TC	SC	TC	SC	TC	SC	TC	SC
71	10.0	5.0	3.8	5.8	4.5	6.5	5.2	7.1	5.3	7.7	5.4	8.7	5.7	9.5	6.2
	12.0	5.0	3.8	5.8	4.5	6.5	5.2	7.1	5.3	7.7	5.4	8.7	5.7	9.5	6.2
	14.0	5.0	3.8	5.8	4.5	6.5	5.2	7.1	5.3	7.7	5.4	8.7	5.7	9.5	6.2
	16.0	5.0	3.8	5.8	4.5	6.5	5.2	7.1	5.3	7.7	5.4	8.7	5.7	9.5	6.2
	18.0	5.0	3.8	5.8	4.5	6.5	5.2	7.1	5.3	7.7	5.4	8.7	5.7	9.5	6.2
	20.0	5.0	3.8	5.8	4.5	6.5	5.2	7.1	5.3	7.7	5.4	8.7	5.7	9.4	6.2
	21.0	5.0	3.8	5.8	4.5	6.5	5.2	7.1	5.3	7.7	5.4	8.7	5.7	9.2	6.1
	23.0	5.0	3.8	5.8	4.5	6.5	5.2	7.1	5.3	7.7	5.4	8.7	5.7	9.1	6.0
	25.0	5.0	3.8	5.8	4.5	6.5	5.2	7.1	5.3	7.7	5.4	8.6	5.8	8.9	6.0
	27.0	5.0	3.8	5.8	4.5	6.5	5.2	7.1	5.3	7.7	5.4	8.4	5.7	8.9	5.9
	29.0	5.0	3.8	5.8	4.5	6.5	5.2	7.1	5.3	7.7	5.4	8.3	5.7	8.7	5.9
	31.0	5.0	3.8	5.8	4.5	6.5	5.2	7.1	5.3	7.7	5.4	8.2	5.8	8.6	5.8
	33.0	5.0	3.8	5.8	4.5	6.5	5.2	7.1	5.3	7.7	5.4	8.2	5.7	8.4	5.7
	35.0	5.0	3.8	5.8	4.5	6.5	5.2	7.1	5.3	7.7	5.4	8.1	5.7	8.4	5.8
	37.0	5.0	3.8	5.8	4.5	6.5	5.2	7.1	5.3	7.7	5.6	8.0	5.7	8.2	5.7
	39.0	5.0	3.8	5.8	4.5	6.5	5.2	7.1	5.3	7.6	5.5	7.8	5.7	8.1	5.6
40.0	5.0	3.8	5.8	4.5	6.5	5.2	7.1	5.3	7.5	5.5	7.7	5.6	8.0	5.6	
43.0	5.0	3.8	5.8	4.5	6.5	5.2	7.1	5.3	7.3	5.4	7.7	5.6	7.8	5.5	
80	10.0	5.6	4.3	6.5	5.1	7.4	5.9	8.0	6.0	8.6	6.1	9.8	6.4	10.7	7.0
	12.0	5.6	4.3	6.5	5.1	7.4	5.9	8.0	6.0	8.6	6.1	9.8	6.4	10.7	7.0
	14.0	5.6	4.3	6.5	5.1	7.4	5.9	8.0	6.0	8.6	6.1	9.8	6.4	10.7	7.0
	16.0	5.6	4.3	6.5	5.1	7.4	5.9	8.0	6.0	8.6	6.1	9.8	6.4	10.7	7.0
	18.0	5.6	4.3	6.5	5.1	7.4	5.9	8.0	6.0	8.6	6.1	9.8	6.4	10.7	7.0
	20.0	5.6	4.3	6.5	5.1	7.4	5.9	8.0	6.0	8.6	6.1	9.8	6.4	10.6	7.0
	21.0	5.6	4.3	6.5	5.1	7.4	5.9	8.0	6.0	8.6	6.1	9.8	6.4	10.4	6.9
	23.0	5.6	4.3	6.5	5.1	7.4	5.9	8.0	6.0	8.6	6.1	9.8	6.4	10.2	6.8
	25.0	5.6	4.3	6.5	5.1	7.4	5.9	8.0	6.0	8.6	6.1	9.7	6.5	10.1	6.8
	27.0	5.6	4.3	6.5	5.1	7.4	5.9	8.0	6.0	8.6	6.1	9.5	6.5	10.0	6.7
	29.0	5.6	4.3	6.5	5.1	7.4	5.9	8.0	6.0	8.6	6.1	9.4	6.5	9.8	6.7
	31.0	5.6	4.3	6.5	5.1	7.4	5.9	8.0	6.0	8.6	6.1	9.3	6.5	9.7	6.6
	33.0	5.6	4.3	6.5	5.1	7.4	5.9	8.0	6.0	8.6	6.1	9.2	6.4	9.5	6.5
	35.0	5.6	4.3	6.5	5.1	7.4	5.9	8.0	6.0	8.6	6.1	9.1	6.5	9.4	6.5
	37.0	5.6	4.3	6.5	5.1	7.4	5.9	8.0	6.0	8.6	6.3	9.0	6.5	9.3	6.4
	39.0	5.6	4.3	6.5	5.1	7.4	5.9	8.0	6.0	8.6	6.2	8.8	6.4	9.1	6.3
40.0	5.6	4.3	6.5	5.1	7.4	5.9	8.0	6.0	8.4	6.2	8.7	6.4	9.0	6.3	
43.0	5.6	4.3	6.5	5.1	7.4	5.9	8.0	6.0	8.2	6.1	8.6	6.3	8.8	6.2	

# DC INVERTER MULTI VRF INDOOR UNIT TECHNICAL SALES GUIDE

Capacity Index	Outdoor temperature (°C DB)	Indoor temperature (°C WB/°C DB)													
		14.0°C WB		16.0°C WB		18.0°C WB		19.0°C WB		20.0°C WB		22.0°C WB		24.0°C WB	
		20°C DB		23°C DB		26°C DB		27°C DB		28°C DB		30°C DB		32°C DB	
		TC	SC	TC	SC	TC	SC	TC	SC	TC	SC	TC	SC	TC	SC
90	10.0	6.3	4.8	7.3	5.7	8.3	6.6	9.0	6.8	9.7	6.9	11.1	7.2	12.1	7.8
	12.0	6.3	4.8	7.3	5.7	8.3	6.6	9.0	6.8	9.7	6.9	11.1	7.2	12.1	7.8
	14.0	6.3	4.8	7.3	5.7	8.3	6.6	9.0	6.8	9.7	6.9	11.1	7.2	12.1	7.8
	16.0	6.3	4.8	7.3	5.7	8.3	6.6	9.0	6.8	9.7	6.9	11.1	7.2	12.1	7.8
	18.0	6.3	4.8	7.3	5.7	8.3	6.6	9.0	6.8	9.7	6.9	11.1	7.2	12.1	7.8
	20.0	6.3	4.8	7.3	5.7	8.3	6.6	9.0	6.8	9.7	6.9	11.1	7.2	12.0	7.9
	21.0	6.3	4.8	7.3	5.7	8.3	6.6	9.0	6.8	9.7	6.9	11.1	7.2	11.7	7.7
	23.0	6.3	4.8	7.3	5.7	8.3	6.6	9.0	6.8	9.7	6.9	11.1	7.2	11.5	7.6
	25.0	6.3	4.8	7.3	5.7	8.3	6.6	9.0	6.8	9.7	6.9	10.9	7.3	11.3	7.6
	27.0	6.3	4.8	7.3	5.7	8.3	6.6	9.0	6.8	9.7	6.9	10.7	7.3	11.3	7.5
	29.0	6.3	4.8	7.3	5.7	8.3	6.6	9.0	6.8	9.7	6.9	10.5	7.3	11.1	7.5
	31.0	6.3	4.8	7.3	5.7	8.3	6.6	9.0	6.8	9.7	6.9	10.4	7.3	10.9	7.4
	33.0	6.3	4.8	7.3	5.7	8.3	6.6	9.0	6.8	9.7	6.9	10.4	7.2	10.7	7.3
	35.0	6.3	4.8	7.3	5.7	8.3	6.6	9.0	6.8	9.7	6.9	10.3	7.3	10.6	7.3
	37.0	6.3	4.8	7.3	5.7	8.3	6.6	9.0	6.8	9.7	7.1	10.1	7.3	10.4	7.2
	39.0	6.3	4.8	7.3	5.7	8.3	6.6	9.0	6.8	9.6	7.0	9.9	7.2	10.3	7.1
40.0	6.3	4.8	7.3	5.7	8.3	6.6	9.0	6.8	9.5	7.0	9.8	7.2	10.1	7.1	
43.0	6.3	4.8	7.3	5.7	8.3	6.6	9.0	6.8	9.3	6.9	9.7	7.1	9.9	6.9	
100	10.0	7.0	5.3	8.1	6.3	9.2	7.4	10.0	7.5	10.8	7.7	12.3	8.0	13.4	8.7
	12.0	7.0	5.3	8.1	6.3	9.2	7.4	10.0	7.5	10.8	7.7	12.3	8.0	13.4	8.7
	14.0	7.0	5.3	8.1	6.3	9.2	7.4	10.0	7.5	10.8	7.7	12.3	8.0	13.4	8.7
	16.0	7.0	5.3	8.1	6.3	9.2	7.4	10.0	7.5	10.8	7.7	12.3	8.0	13.4	8.7
	18.0	7.0	5.3	8.1	6.3	9.2	7.4	10.0	7.5	10.8	7.7	12.3	8.0	13.4	8.7
	20.0	7.0	5.3	8.1	6.3	9.2	7.4	10.0	7.5	10.8	7.7	12.3	8.0	13.3	8.8
	21.0	7.0	5.3	8.1	6.3	9.2	7.4	10.0	7.5	10.8	7.7	12.3	8.0	13.0	8.6
	23.0	7.0	5.3	8.1	6.3	9.2	7.4	10.0	7.5	10.8	7.7	12.3	8.0	12.8	8.4
	25.0	7.0	5.3	8.1	6.3	9.2	7.4	10.0	7.5	10.8	7.7	12.1	8.1	12.6	8.4
	27.0	7.0	5.3	8.1	6.3	9.2	7.4	10.0	7.5	10.8	7.7	11.9	8.1	12.5	8.4
	29.0	7.0	5.3	8.1	6.3	9.2	7.4	10.0	7.5	10.8	7.7	11.7	8.1	12.3	8.4
	31.0	7.0	5.3	8.1	6.3	9.2	7.4	10.0	7.5	10.8	7.7	11.6	8.1	12.1	8.2
	33.0	7.0	5.3	8.1	6.3	9.2	7.4	10.0	7.5	10.8	7.7	11.5	8.1	11.9	8.1
	35.0	7.0	5.3	8.1	6.3	9.2	7.4	10.0	7.5	10.8	7.7	11.4	8.1	11.8	8.1
	37.0	7.0	5.3	8.1	6.3	9.2	7.4	10.0	7.5	10.8	7.9	11.2	8.1	11.6	8.0
	39.0	7.0	5.3	8.1	6.3	9.2	7.4	10.0	7.5	10.7	7.8	11.0	8.0	11.4	7.9
40.0	7.0	5.3	8.1	6.3	9.2	7.4	10.0	7.5	10.5	7.8	10.9	8.0	11.2	7.8	
43.0	7.0	5.3	8.1	6.3	9.2	7.4	10.0	7.5	10.3	7.6	10.8	7.9	11.0	7.7	

Capacity Index	Outdoor temperature (°C DB)	Indoor temperature (°C WB/°C DB)													
		14.0°C WB		16.0°C WB		18.0°C WB		19.0°C WB		20.0°C WB		22.0°C WB		24.0°C WB	
		20°C DB		23°C DB		26°C DB		27°C DB		28°C DB		30°C DB		32°C DB	
		TC	SC	TC	SC	TC	SC	TC	SC	TC	SC	TC	SC	TC	SC
112	10.0	7.8	6.0	9.1	7.1	10.3	8.2	11.2	8.4	12.1	8.6	13.8	9.0	15.0	9.8
	12.0	7.8	6.0	9.1	7.1	10.3	8.2	11.2	8.4	12.1	8.6	13.8	9.0	15.0	9.8
	14.0	7.8	6.0	9.1	7.1	10.3	8.2	11.2	8.4	12.1	8.6	13.8	9.0	15.0	9.8
	16.0	7.8	6.0	9.1	7.1	10.3	8.2	11.2	8.4	12.1	8.6	13.8	9.0	15.0	9.8
	18.0	7.8	6.0	9.1	7.1	10.3	8.2	11.2	8.4	12.1	8.6	13.8	9.0	15.0	9.8
	20.0	7.8	6.0	9.1	7.1	10.3	8.2	11.2	8.4	12.1	8.6	13.8	9.0	14.9	9.8
	21.0	7.8	6.0	9.1	7.1	10.3	8.2	11.2	8.4	12.1	8.6	13.8	9.0	14.6	9.6
	23.0	7.8	6.0	9.1	7.1	10.3	8.2	11.2	8.4	12.1	8.6	13.8	9.0	14.3	9.5
	25.0	7.8	6.0	9.1	7.1	10.3	8.2	11.2	8.4	12.1	8.6	13.6	9.1	14.1	9.5
	27.0	7.8	6.0	9.1	7.1	10.3	8.2	11.2	8.4	12.1	8.6	13.3	9.0	14.0	9.4
	29.0	7.8	6.0	9.1	7.1	10.3	8.2	11.2	8.4	12.1	8.6	13.1	9.0	13.8	9.4
	31.0	7.8	6.0	9.1	7.1	10.3	8.2	11.2	8.4	12.1	8.6	13.0	9.1	13.6	9.2
	33.0	7.8	6.0	9.1	7.1	10.3	8.2	11.2	8.4	12.1	8.6	12.9	9.0	13.3	9.1
	35.0	7.8	6.0	9.1	7.1	10.3	8.2	11.2	8.4	12.1	8.6	12.8	9.1	13.2	9.1
	37.0	7.8	6.0	9.1	7.1	10.3	8.2	11.2	8.4	12.1	8.8	12.5	9.0	13.0	9.0
	39.0	7.8	6.0	9.1	7.1	10.3	8.2	11.2	8.4	12.0	8.7	12.3	9.0	12.8	8.8
40.0	7.8	6.0	9.1	7.1	10.3	8.2	11.2	8.4	11.8	8.7	12.2	8.9	12.5	8.8	
43.0	7.8	6.0	9.1	7.1	10.3	8.2	11.2	8.4	11.5	8.5	12.1	8.8	12.3	8.6	
125	10.0	8.8	6.7	10.1	7.9	11.5	9.2	12.5	9.4	13.5	9.6	15.4	10.0	16.8	10.9
	12.0	8.8	6.7	10.1	7.9	11.5	9.2	12.5	9.4	13.5	9.6	15.4	10.0	16.8	10.9
	14.0	8.8	6.7	10.1	7.9	11.5	9.2	12.5	9.4	13.5	9.6	15.4	10.0	16.8	10.9
	16.0	8.8	6.7	10.1	7.9	11.5	9.2	12.5	9.4	13.5	9.6	15.4	10.0	16.8	10.9
	18.0	8.8	6.7	10.1	7.9	11.5	9.2	12.5	9.4	13.5	9.6	15.4	10.0	16.8	10.9
	20.0	8.8	6.7	10.1	7.9	11.5	9.2	12.5	9.4	13.5	9.6	15.4	10.0	16.6	11.0
	21.0	8.8	6.7	10.1	7.9	11.5	9.2	12.5	9.4	13.5	9.6	15.4	10.0	16.3	10.7
	23.0	8.8	6.7	10.1	7.9	11.5	9.2	12.5	9.4	13.5	9.6	15.4	10.0	16.0	10.6
	25.0	8.8	6.7	10.1	7.9	11.5	9.2	12.5	9.4	13.5	9.6	15.1	10.1	15.8	10.6
	27.0	8.8	6.7	10.1	7.9	11.5	9.2	12.5	9.4	13.5	9.6	14.9	10.1	15.6	10.5
	29.0	8.8	6.7	10.1	7.9	11.5	9.2	12.5	9.4	13.5	9.6	14.6	10.1	15.4	10.5
	31.0	8.8	6.7	10.1	7.9	11.5	9.2	12.5	9.4	13.5	9.6	14.5	10.2	15.1	10.3
	33.0	8.8	6.7	10.1	7.9	11.5	9.2	12.5	9.4	13.5	9.6	14.4	10.1	14.9	10.1
	35.0	8.8	6.7	10.1	7.9	11.5	9.2	12.5	9.4	13.5	9.6	14.3	10.1	14.8	10.2
	37.0	8.8	6.7	10.1	7.9	11.5	9.2	12.5	9.4	13.5	9.9	14.0	10.1	14.5	10.0
	39.0	8.8	6.7	10.1	7.9	11.5	9.2	12.5	9.4	13.4	9.8	13.8	10.0	14.3	9.8
40.0	8.8	6.7	10.1	7.9	11.5	9.2	12.5	9.4	13.1	9.7	13.6	9.9	14.0	9.8	
43.0	8.8	6.7	10.1	7.9	11.5	9.2	12.5	9.4	12.9	9.5	13.5	9.9	13.8	9.6	

# DC INVERTER MULTI VRF INDOOR UNIT TECHNICAL SALES GUIDE

Capacity Index	Outdoor temperature (°C DB)	Indoor temperature (°C WB/°C DB)													
		14.0°C WB		16.0°C WB		18.0°C WB		19.0°C WB		20.0°C WB		22.0°C WB		24.0°C WB	
		20°C DB		23°C DB		26°C DB		27°C DB		28°C DB		30°C DB		32°C DB	
		TC	SC	TC	SC	TC	SC	TC	SC	TC	SC	TC	SC	TC	SC
140	10.0	9.8	7.4	11.3	8.8	12.9	10.3	14.0	10.5	15.1	10.7	17.2	11.2	18.8	12.2
	12.0	9.8	7.4	11.3	8.8	12.9	10.3	14.0	10.5	15.1	10.7	17.2	11.2	18.8	12.2
	14.0	9.8	7.4	11.3	8.8	12.9	10.3	14.0	10.5	15.1	10.7	17.2	11.2	18.8	12.2
	16.0	9.8	7.4	11.3	8.8	12.9	10.3	14.0	10.5	15.1	10.7	17.2	11.2	18.8	12.2
	18.0	9.8	7.4	11.3	8.8	12.9	10.3	14.0	10.5	15.1	10.7	17.2	11.2	18.8	12.2
	20.0	9.8	7.4	11.3	8.8	12.9	10.3	14.0	10.5	15.1	10.7	17.2	11.2	18.6	12.3
	21.0	9.8	7.4	11.3	8.8	12.9	10.3	14.0	10.5	15.1	10.7	17.2	11.2	18.2	12.0
	23.0	9.8	7.4	11.3	8.8	12.9	10.3	14.0	10.5	15.1	10.7	17.2	11.2	17.9	11.8
	25.0	9.8	7.4	11.3	8.8	12.9	10.3	14.0	10.5	15.1	10.7	16.9	11.3	17.6	11.8
	27.0	9.8	7.4	11.3	8.8	12.9	10.3	14.0	10.5	15.1	10.7	16.6	11.3	17.5	11.7
	29.0	9.8	7.4	11.3	8.8	12.9	10.3	14.0	10.5	15.1	10.7	16.4	11.3	17.2	11.7
	31.0	9.8	7.4	11.3	8.8	12.9	10.3	14.0	10.5	15.1	10.7	16.2	11.4	16.9	11.5
	33.0	9.8	7.4	11.3	8.8	12.9	10.3	14.0	10.5	15.1	10.7	16.1	11.3	16.7	11.3
	35.0	9.8	7.4	11.3	8.8	12.9	10.3	14.0	10.5	15.1	10.7	16.0	11.3	16.5	11.4
	37.0	9.8	7.4	11.3	8.8	12.9	10.3	14.0	10.5	15.1	11.0	15.7	11.3	16.2	11.2
	39.0	9.8	7.4	11.3	8.8	12.9	10.3	14.0	10.5	15.0	10.9	15.4	11.2	16.0	11.0
40.0	9.8	7.4	11.3	8.8	12.9	10.3	14.0	10.5	14.7	10.9	15.3	11.1	15.7	11.0	
43.0	9.8	7.4	11.3	8.8	12.9	10.3	14.0	10.5	14.4	10.7	15.1	11.0	15.4	10.8	
160	10.0	11.2	8.5	13.0	10.1	14.7	11.8	16.0	12.0	17.3	12.3	19.7	12.8	21.4	13.9
	12.0	11.2	8.5	13.0	10.1	14.7	11.8	16.0	12.0	17.3	12.3	19.7	12.8	21.4	13.9
	14.0	11.2	8.5	13.0	10.1	14.7	11.8	16.0	12.0	17.3	12.3	19.7	12.8	21.4	13.9
	16.0	11.2	8.5	13.0	10.1	14.7	11.8	16.0	12.0	17.3	12.3	19.7	12.8	21.4	13.9
	18.0	11.2	8.5	13.0	10.1	14.7	11.8	16.0	12.0	17.3	12.3	19.7	12.8	21.4	13.9
	20.0	11.2	8.5	13.0	10.1	14.7	11.8	16.0	12.0	17.3	12.3	19.7	12.8	21.3	14.0
	21.0	11.2	8.5	13.0	10.1	14.7	11.8	16.0	12.0	17.3	12.3	19.7	12.8	20.8	13.7
	23.0	11.2	8.5	13.0	10.1	14.7	11.8	16.0	12.0	17.3	12.3	19.7	12.8	20.5	13.5
	25.0	11.2	8.5	13.0	10.1	14.7	11.8	16.0	12.0	17.3	12.3	19.4	13.0	20.2	13.5
	27.0	11.2	8.5	13.0	10.1	14.7	11.8	16.0	12.0	17.3	12.3	19.0	12.9	20.0	13.4
	29.0	11.2	8.5	13.0	10.1	14.7	11.8	16.0	12.0	17.3	12.3	18.7	12.9	19.7	13.4
	31.0	11.2	8.5	13.0	10.1	14.7	11.8	16.0	12.0	17.3	12.3	18.6	13.0	19.4	13.2
	33.0	11.2	8.5	13.0	10.1	14.7	11.8	16.0	12.0	17.3	12.3	18.4	12.9	19.0	12.9
	35.0	11.2	8.5	13.0	10.1	14.7	11.8	16.0	12.0	17.3	12.3	18.2	13.0	18.9	13.0
	37.0	11.2	8.5	13.0	10.1	14.7	11.8	16.0	12.0	17.3	12.6	17.9	12.9	18.6	12.8
	39.0	11.2	8.5	13.0	10.1	14.7	11.8	16.0	12.0	17.1	12.5	17.6	12.8	18.2	12.6
40.0	11.2	8.5	13.0	10.1	14.7	11.8	16.0	12.0	16.8	12.4	17.4	12.7	17.9	12.5	
43.0	11.2	8.5	13.0	10.1	14.7	11.8	16.0	12.0	16.5	12.2	17.3	12.6	17.6	12.3	

Capacity Index	Outdoor temperature (°C DB)	Indoor temperature (°C WB/°C DB)													
		14.0°C WB		16.0°C WB		18.0°C WB		19.0°C WB		20.0°C WB		22.0°C WB		24.0°C WB	
		20°C DB		23°C DB		26°C DB		27°C DB		28°C DB		30°C DB		32°C DB	
		TC	SC	TC	SC	TC	SC	TC	SC	TC	SC	TC	SC	TC	SC
180	10.0	126	96	146	114	166	132	180	135	194	138	221	144	241	157
	12.0	126	96	146	114	166	132	180	135	194	138	221	144	241	157
	14.0	126	96	146	114	166	132	180	135	194	138	221	144	241	157
	16.0	126	96	146	114	166	132	180	135	194	138	221	144	241	157
	18.0	126	96	146	114	166	132	180	135	194	138	221	144	241	157
	20.0	126	96	146	114	166	132	180	135	194	138	221	144	239	158
	21.0	126	96	146	114	166	132	180	135	194	138	221	144	234	154
	23.0	126	96	146	114	166	132	180	135	194	138	221	144	230	152
	25.0	126	96	146	114	166	132	180	135	194	138	218	146	227	152
	27.0	126	96	146	114	166	132	180	135	194	138	214	145	225	151
	29.0	126	96	146	114	166	132	180	135	194	138	211	145	221	151
	31.0	126	96	146	114	166	132	180	135	194	138	209	146	218	148
	33.0	126	96	146	114	166	132	180	135	194	138	207	145	214	146
	35.0	126	96	146	114	166	132	180	135	194	138	205	146	212	147
	37.0	126	96	146	114	166	132	180	135	194	142	202	145	209	144
	39.0	126	96	146	114	166	132	180	135	193	141	198	145	205	142
40.0	126	96	146	114	166	132	180	135	189	140	196	143	202	141	
43.0	126	96	146	114	166	132	180	135	185	137	194	142	198	139	
224	10.0	15.7	11.9	18.1	14.2	20.6	16.5	22.4	16.8	24.2	17.2	27.6	17.9	30.0	19.5
	12.0	15.7	11.9	18.1	14.2	20.6	16.5	22.4	16.8	24.2	17.2	27.6	17.9	30.0	19.5
	14.0	15.7	11.9	18.1	14.2	20.6	16.5	22.4	16.8	24.2	17.2	27.6	17.9	30.0	19.5
	16.0	15.7	11.9	18.1	14.2	20.6	16.5	22.4	16.8	24.2	17.2	27.6	17.9	30.0	19.5
	18.0	15.7	11.9	18.1	14.2	20.6	16.5	22.4	16.8	24.2	17.2	27.6	17.9	30.0	19.5
	20.0	15.7	11.9	18.1	14.2	20.6	16.5	22.4	16.8	24.2	17.2	27.6	17.9	29.8	19.7
	21.0	15.7	11.9	18.1	14.2	20.6	16.5	22.4	16.8	24.2	17.2	27.6	17.9	29.1	19.2
	23.0	15.7	11.9	18.1	14.2	20.6	16.5	22.4	16.8	24.2	17.2	27.6	17.9	28.7	18.9
	25.0	15.7	11.9	18.1	14.2	20.6	16.5	22.4	16.8	24.2	17.2	27.1	18.2	28.2	18.9
	27.0	15.7	11.9	18.1	14.2	20.6	16.5	22.4	16.8	24.2	17.2	26.6	18.1	28.0	18.8
	29.0	15.7	11.9	18.1	14.2	20.6	16.5	22.4	16.8	24.2	17.2	26.2	18.1	27.6	18.7
	31.0	15.7	11.9	18.1	14.2	20.6	16.5	22.4	16.8	24.2	17.2	26.0	18.2	27.1	18.4
	33.0	15.7	11.9	18.1	14.2	20.6	16.5	22.4	16.8	24.2	17.2	25.8	18.0	26.7	18.1
	35.0	15.7	11.9	18.1	14.2	20.6	16.5	22.4	16.8	24.2	17.2	25.5	18.1	26.4	18.2
	37.0	15.7	11.9	18.1	14.2	20.6	16.5	22.4	16.8	24.2	17.7	25.1	18.1	26.0	17.9
	39.0	15.7	11.9	18.1	14.2	20.6	16.5	22.4	16.8	24.0	17.5	24.6	18.0	25.5	17.6
40.0	15.7	11.9	18.1	14.2	20.6	16.5	22.4	16.8	23.5	17.4	24.4	17.8	25.1	17.6	
43.0	15.7	11.9	18.1	14.2	20.6	16.5	22.4	16.8	23.1	17.1	24.2	17.7	24.6	17.2	



# DC INVERTER MULTI VRF INDOOR UNIT TECHNICAL SALES GUIDE

Capacity Index	Outdoor temperature (°C DB)	Indoor temperature (°C WB/°C DB)													
		14.0°C WB		16.0°C WB		18.0°C WB		19.0°C WB		20.0°C WB		22.0°C WB		24.0°C WB	
		20°C DB		23°C DB		26°C DB		27°C DB		28°C DB		30°C DB		32°C DB	
		TC	SC	TC	SC	TC	SC	TC	SC	TC	SC	TC	SC	TC	SC
280	10.0	19.6	14.9	22.7	19.6	25.8	20.6	28.0	21.0	30.2	21.5	34.4	22.4	37.5	24.4
	12.0	19.6	14.9	22.7	19.6	25.8	20.6	28.0	21.0	30.2	21.5	34.4	22.4	37.5	24.4
	14.0	19.6	14.9	22.7	19.6	25.8	20.6	28.0	21.0	30.2	21.5	34.4	22.4	37.5	24.4
	16.0	19.6	14.9	22.7	19.6	25.8	20.6	28.0	21.0	30.2	21.5	34.4	22.4	37.5	24.4
	18.0	19.6	14.9	22.7	19.6	25.8	20.6	28.0	21.0	30.2	21.5	34.4	22.4	37.5	24.4
	20.0	19.6	14.9	22.7	19.6	25.8	20.6	28.0	21.0	30.2	21.5	34.4	22.4	37.2	24.6
	21.0	19.6	14.9	22.7	19.6	25.8	20.6	28.0	21.0	30.2	21.5	34.4	22.4	36.4	24.0
	23.0	19.6	14.9	22.7	19.6	25.8	20.6	28.0	21.0	30.2	21.5	34.4	22.4	35.8	23.7
	25.0	19.6	14.9	22.7	19.6	25.8	20.6	28.0	21.0	30.2	21.5	33.9	22.7	35.3	23.6
	27.0	19.6	14.9	22.7	19.6	25.8	20.6	28.0	21.0	30.2	21.5	33.3	22.6	35.0	23.5
	29.0	19.6	14.9	22.7	19.6	25.8	20.6	28.0	21.0	30.2	21.5	32.8	22.6	34.4	23.4
	31.0	19.6	14.9	22.7	19.6	25.8	20.6	28.0	21.0	30.2	21.5	32.5	22.7	33.9	23.0
	33.0	19.6	14.9	22.7	19.6	25.8	20.6	28.0	21.0	30.2	21.5	32.2	22.5	33.3	22.7
	35.0	19.6	14.9	22.7	19.6	25.8	20.6	28.0	21.0	30.2	21.5	31.9	22.7	33.0	22.8
	37.0	19.6	14.9	22.7	19.6	25.8	20.6	28.0	21.0	30.2	22.1	31.4	22.6	32.5	22.4
	39.0	19.6	14.9	22.7	19.6	25.8	20.6	28.0	21.0	30.0	21.9	30.8	22.5	31.9	21.1
40.0	19.6	14.9	22.7	19.6	25.8	20.6	28.0	21.0	29.4	21.8	30.5	22.3	31.4	22.0	
43.0	19.6	14.9	22.7	19.6	25.8	20.6	28.0	21.0	28.8	21.3	30.2	22.1	30.8	21.6	

## 4.2 Heating Capacity Correction

TC: Total Capacity; SC: Sensible Capacity

Capacity Index	Outdoor temperature		Indoor temperature °C DB						
			16.0	18.0	20.0	21.0	22.0	24.0	26.0
	°C DB	°C WB	TC	TC	TC	TC	TC	TC	TC
15	-19.7	-20	1.0	1.0	1.0	1.0	1.0	1.0	1.0
	-14.7	-15.0	1.1	1.1	1.1	1.1	1.1	1.1	1.1
	-12.6	-13.0	1.2	1.2	1.2	1.2	1.2	1.2	1.1
	-10.5	-11.0	1.2	1.2	1.2	1.2	1.2	1.2	1.2
	-9.5	-10.0	1.2	1.2	1.2	1.2	1.2	1.2	1.2
	-8.5	-9.1	1.3	1.3	1.3	1.3	1.3	1.3	1.2
	-7.0	-7.6	1.3	1.3	1.3	1.3	1.3	1.3	1.2
	-5.0	-5.6	1.4	1.4	1.4	1.4	1.4	1.4	1.4
	-3.0	-3.7	1.4	1.4	1.4	1.4	1.4	1.4	1.4
	0.0	-0.7	1.5	1.5	1.5	1.5	1.5	1.4	1.4
	3.0	2.2	1.6	1.6	1.6	1.6	1.6	1.4	1.4
	5.0	4.1	1.6	1.6	1.6	1.6	1.6	1.4	1.4
	7.0	6.0	1.7	1.7	1.7	1.6	1.6	1.4	1.4
	9.0	7.9	1.8	1.8	1.7	1.6	1.6	1.4	1.4
	11.0	9.8	1.8	1.8	1.7	1.6	1.6	1.4	1.4
13.0	11.8	1.9	1.8	1.7	1.6	1.6	1.4	1.4	
15.0	13.7	2.0	1.8	1.7	1.6	1.6	1.4	1.4	
18	-19.7	-20	1.1	1.1	1.1	1.1	1.1	1.1	1.1
	-14.7	-15.0	1.3	1.3	1.3	1.3	1.3	1.3	1.3
	-12.6	-13.0	1.4	1.4	1.4	1.4	1.4	1.4	1.3
	-10.5	-11.0	1.5	1.5	1.5	1.5	1.5	1.5	1.5
	-9.5	-10.0	1.5	1.5	1.5	1.5	1.5	1.5	1.5
	-8.5	-9.1	1.6	1.6	1.6	1.6	1.6	1.6	1.5
	-7.0	-7.6	1.6	1.6	1.6	1.6	1.6	1.6	1.5
	-5.0	-5.6	1.6	1.6	1.6	1.6	1.6	1.6	1.6
	-3.0	-3.7	1.7	1.7	1.7	1.7	1.7	1.7	1.6
	0.0	-0.7	1.8	1.8	1.8	1.8	1.8	1.7	1.6
	3.0	2.2	2.0	2.0	2.0	2.0	1.9	1.7	1.6
	5.0	4.1	2.0	2.0	2.0	2.0	1.9	1.7	1.6
	7.0	6.0	2.0	2.0	2.0	2.0	1.9	1.7	1.6
	9.0	7.9	2.1	2.1	2.0	2.0	1.9	1.7	1.6
	11.0	9.8	2.2	2.2	2.0	2.0	1.9	1.7	1.6
13.0	11.8	2.3	2.2	2.0	2.0	1.9	1.7	1.6	
15.0	13.7	2.4	2.2	2.0	2.0	1.9	1.7	1.6	

# DC INVERTER MULTI VRF INDOOR UNIT TECHNICAL SALES GUIDE

Capacity Index	Outdoor temperature		Indoor temperature °C DB						
			16.0	18.0	20.0	21.0	22.0	24.0	26.0
	°C DB	°C WB	TC	TC	TC	TC	TC	TC	TC
22	-19.7	-20	1.4	1.4	1.4	1.4	1.4	1.4	1.4
	-14.7	-15.0	1.6	1.6	1.6	1.6	1.6	1.6	1.6
	-12.6	-13.0	1.7	1.7	1.7	1.7	1.7	1.7	1.6
	-10.5	-11.0	1.8	1.8	1.8	1.8	1.8	1.8	1.8
	-9.5	-10.0	1.8	1.8	1.8	1.8	1.8	1.8	1.8
	-8.5	-9.1	1.9	1.9	1.9	1.9	1.9	1.9	1.8
	-7.0	-7.6	1.9	1.9	1.9	1.9	1.9	1.9	1.8
	-5.0	-5.6	2.0	2.0	2.0	2.0	2.0	2.0	2.0
	-3.0	-3.7	2.1	2.1	2.1	2.1	2.1	2.1	2.0
	0.0	-0.7	2.2	2.2	2.2	2.2	2.2	2.1	2.0
	3.0	2.2	2.4	2.4	2.4	2.4	2.3	2.1	2.0
	5.0	4.1	2.4	2.4	2.4	2.4	2.3	2.1	2.0
	7.0	6.0	2.5	2.5	2.5	2.4	2.3	2.1	2.0
	9.0	7.9	2.6	2.6	2.5	2.4	2.3	2.1	2.0
	11.0	9.8	2.7	2.7	2.5	2.4	2.3	2.1	2.0
13.0	11.8	2.8	2.7	2.5	2.4	2.3	2.1	2.0	
15.0	13.7	2.9	2.7	2.5	2.4	2.3	2.1	2.0	
25	-19.7	-20	1.6	1.6	1.6	1.6	1.6	1.6	1.5
	-14.7	-15.0	1.8	1.8	1.8	1.8	1.8	1.8	1.7
	-12.6	-13.0	1.9	1.9	1.9	1.9	1.9	1.9	1.8
	-10.5	-11.0	2.0	2.0	2.0	2.0	2.0	2.0	2.0
	-9.5	-10.0	2.0	2.0	2.0	2.0	2.0	2.0	2.0
	-8.5	-9.1	2.1	2.1	2.1	2.1	2.1	2.1	2.1
	-7.0	-7.6	2.1	2.1	2.1	2.1	2.1	2.1	2.1
	-5.0	-5.6	2.2	2.2	2.2	2.2	2.2	2.2	2.2
	-3.0	-3.7	2.4	2.4	2.4	2.4	2.4	2.4	2.2
	0.0	-0.7	2.5	2.5	2.5	2.5	2.5	2.4	2.2
	3.0	2.2	2.7	2.7	2.7	2.7	2.6	2.4	2.2
	5.0	4.1	2.7	2.7	2.7	2.7	2.6	2.4	2.2
	7.0	6.0	2.8	2.8	2.8	2.7	2.6	2.4	2.2
	9.0	7.9	2.9	2.9	2.8	2.7	2.6	2.4	2.2
	11.0	9.8	3.0	3.0	2.8	2.7	2.6	2.4	2.2
13.0	11.8	3.1	3.0	2.8	2.7	2.6	2.4	2.2	
15.0	13.7	3.2	3.0	2.8	2.7	2.6	2.4	2.2	

Capacity Index	Outdoor temperature		Indoor temperature °C DB						
			16.0	18.0	20.0	21.0	22.0	24.0	26.0
	°C DB	°C WB	TC	TC	TC	TC	TC	TC	TC
28	-19.7	-20	1.8	1.8	1.8	1.8	1.8	1.8	1.8
	-14.7	-15.0	2.0	2.0	2.0	2.0	2.0	2.0	2.0
	-12.6	-13.0	2.2	2.2	2.2	2.2	2.2	2.2	2.1
	-10.5	-11.0	2.3	2.3	2.3	2.3	2.3	2.3	2.3
	-9.5	-10.0	2.3	2.3	2.3	2.3	2.3	2.3	2.2
	-8.5	-9.1	2.4	2.4	2.4	2.4	2.4	2.4	2.4
	-7.0	-7.6	2.4	2.4	2.4	2.4	2.4	2.4	2.4
	-5.0	-5.6	2.6	2.6	2.6	2.6	2.6	2.6	2.6
	-3.0	-3.7	2.7	2.7	2.7	2.7	2.7	2.7	2.6
	0.0	-0.7	2.8	2.8	2.8	2.8	2.8	2.7	2.6
	3.0	2.2	3.1	3.1	3.1	3.1	3.0	2.7	2.6
	5.0	4.1	3.1	3.1	3.1	3.1	3.0	2.7	2.6
	7.0	6.0	3.2	3.2	3.2	3.1	3.0	2.7	2.6
	9.0	7.9	3.3	3.3	3.2	3.1	3.0	2.7	2.6
11.0	9.8	3.5	3.5	3.2	3.1	3.0	2.7	2.6	
13.0	11.8	3.6	3.5	3.2	3.1	3.0	2.7	2.6	
15.0	13.7	3.7	3.5	3.2	3.1	3.0	2.7	2.6	
32	-19.7	-20	2.0	2.0	2.0	2.0	2.0	2.0	2.0
	-14.7	-15.0	2.3	2.3	2.3	2.3	2.3	2.3	2.2
	-12.6	-13.0	2.4	2.4	2.4	2.4	2.4	2.4	2.4
	-10.5	-11.0	2.6	2.6	2.6	2.6	2.6	2.6	2.5
	-9.5	-10.0	2.6	2.6	2.6	2.6	2.6	2.6	2.5
	-8.5	-9.1	2.7	2.7	2.7	2.7	2.7	2.7	2.6
	-7.0	-7.6	2.7	2.7	2.7	2.7	2.7	2.7	2.6
	-5.0	-5.6	2.9	2.9	2.9	2.9	2.9	2.9	2.9
	-3.0	-3.7	3.0	3.0	3.0	3.0	3.0	3.0	2.9
	0.0	-0.7	3.2	3.2	3.2	3.2	3.2	3.0	2.9
	3.0	2.2	3.5	3.5	3.5	3.5	3.3	3.0	2.9
	5.0	4.1	3.5	3.5	3.5	3.5	3.3	3.0	2.9
	7.0	6.0	3.6	3.6	3.6	3.5	3.3	3.0	2.9
	9.0	7.9	3.7	3.7	3.6	3.5	3.3	3.0	2.9
11.0	9.8	3.9	3.9	3.6	3.5	3.3	3.0	2.9	
13.0	11.8	4.0	3.9	3.6	3.5	3.3	3.0	2.9	
15.0	13.7	4.2	3.9	3.6	3.5	3.3	3.0	2.9	

# DC INVERTER MULTI VRF INDOOR UNIT TECHNICAL SALES GUIDE

Capacity Index	Outdoor temperature		Indoor temperature °C DB						
			16.0	18.0	20.0	21.0	22.0	24.0	26.0
	°C DB	°C WB	TC	TC	TC	TC	TC	TC	TC
36	-19.7	-20	2.2	2.2	2.2	2.2	2.2	2.2	2.2
	-14.7	-15.0	2.6	2.6	2.6	2.6	2.6	2.6	2.5
	-12.6	-13.0	2.7	2.7	2.7	2.7	2.7	2.7	2.6
	-10.5	-11.0	2.9	2.9	2.9	2.9	2.9	2.9	2.8
	-9.5	-10.0	2.9	2.9	2.9	2.9	2.9	2.9	2.8
	-8.5	-9.1	3.0	3.0	3.0	3.0	3.0	3.0	2.9
	-7.0	-7.6	3.0	3.0	3.0	3.0	3.0	3.0	2.9
	-5.0	-5.6	3.2	3.2	3.2	3.2	3.2	3.2	3.2
	-3.0	-3.7	3.4	3.4	3.4	3.4	3.4	3.4	3.2
	0.0	-0.7	3.5	3.5	3.5	3.5	3.5	3.4	3.2
	3.0	2.2	3.8	3.8	3.8	3.8	3.7	3.4	3.2
	5.0	4.1	3.8	3.8	3.8	3.8	3.7	3.4	3.2
	7.0	6.0	4.0	4.0	4.0	3.8	3.7	3.4	3.2
	9.0	7.9	4.2	4.2	4.0	3.8	3.7	3.4	3.2
11.0	9.8	4.3	4.3	4.0	3.8	3.7	3.4	3.2	
13.0	11.8	4.5	4.3	4.0	3.8	3.7	3.4	3.2	
15.0	13.7	4.6	4.3	4.0	3.8	3.7	3.4	3.2	
40	-19.7	-20	2.5	2.5	2.5	2.5	2.5	2.5	2.5
	-14.7	-15.0	2.9	2.9	2.9	2.9	2.9	2.9	2.8
	-12.6	-13.0	3.1	3.1	3.1	3.1	3.1	3.1	3.0
	-10.5	-11.0	3.2	3.2	3.2	3.2	3.2	3.2	3.2
	-9.5	-10.0	3.2	3.2	3.2	3.2	3.2	3.2	3.2
	-8.5	-9.1	3.4	3.4	3.4	3.4	3.4	3.4	3.3
	-7.0	-7.6	3.4	3.4	3.4	3.4	3.4	3.4	3.3
	-5.0	-5.6	3.6	3.6	3.6	3.6	3.6	3.6	3.6
	-3.0	-3.7	3.8	3.8	3.8	3.8	3.8	3.8	3.6
	0.0	-0.7	4.0	4.0	4.0	4.0	4.0	3.8	3.6
	3.0	2.2	4.3	4.3	4.3	4.3	4.1	3.8	3.6
	5.0	4.1	4.3	4.3	4.3	4.3	4.1	3.8	3.6
	7.0	6.0	4.5	4.5	4.5	4.3	4.1	3.8	3.6
	9.0	7.9	4.7	4.7	4.5	4.3	4.1	3.8	3.6
11.0	9.8	4.9	4.9	4.5	4.3	4.1	3.8	3.6	
13.0	11.8	5.1	4.9	4.5	4.3	4.1	3.8	3.6	
15.0	13.7	5.2	4.9	4.5	4.3	4.1	3.8	3.6	

Capacity Index	Outdoor temperature		Indoor temperature °C DB						
			16.0	18.0	20.0	21.0	22.0	24.0	26.0
	°C DB	°C WB	TC	TC	TC	TC	TC	TC	TC
45	-19.7	-20	2.8	2.8	2.8	2.8	2.8	2.8	2.8
	-14.7	-15.0	3.2	3.2	3.2	3.2	3.2	3.2	3.1
	-12.6	-13.0	3.4	3.4	3.4	3.4	3.4	3.4	3.3
	-10.5	-11.0	3.6	3.6	3.6	3.6	3.6	3.6	3.5
	-9.5	-10.0	3.6	3.6	3.6	3.6	3.6	3.6	3.5
	-8.5	-9.1	3.8	3.8	3.8	3.8	3.8	3.8	3.7
	-7.0	-7.6	3.8	3.8	3.8	3.8	3.8	3.8	3.7
	-5.0	-5.6	4.0	4.0	4.0	4.0	4.0	4.0	4.0
	-3.0	-3.7	4.2	4.2	4.2	4.2	4.2	4.2	4.0
	0.0	-0.7	4.4	4.4	4.4	4.4	4.4	4.2	4.0
	3.0	2.2	4.8	4.8	4.8	4.8	4.6	4.2	4.0
	5.0	4.1	4.8	4.8	4.8	4.8	4.6	4.2	4.0
	7.0	6.0	5.0	5.0	5.0	4.8	4.6	4.2	4.0
	9.0	7.9	5.2	5.2	5.0	4.8	4.6	4.2	4.0
11.0	9.8	5.4	5.4	5.0	4.8	4.6	4.2	4.0	
13.0	11.8	5.6	5.4	5.0	4.8	4.6	4.2	4.0	
15.0	13.7	5.8	5.4	5.0	4.8	4.6	4.2	4.0	
50	-19.7	-20	3.1	3.1	3.1	3.1	3.1	3.1	3.1
	-14.7	-15.0	3.6	3.6	3.6	3.6	3.6	3.6	3.5
	-12.6	-13.0	3.8	3.8	3.8	3.8	3.8	3.8	3.7
	-10.5	-11.0	4.0	4.0	4.0	4.0	4.0	4.0	3.9
	-9.5	-10.0	4.0	4.0	4.0	4.0	4.0	4.0	3.9
	-8.5	-9.1	4.3	4.3	4.3	4.3	4.3	4.3	4.1
	-7.0	-7.6	4.3	4.3	4.3	4.3	4.3	4.3	4.1
	-5.0	-5.6	4.5	4.5	4.5	4.5	4.5	4.5	4.5
	-3.0	-3.7	4.7	4.7	4.7	4.7	4.7	4.7	4.5
	0.0	-0.7	4.9	4.9	4.9	4.9	4.9	4.7	4.5
	3.0	2.2	5.4	5.4	5.4	5.4	5.2	4.7	4.5
	5.0	4.1	5.4	5.4	5.4	5.4	5.2	4.7	4.5
	7.0	6.0	5.6	5.6	5.6	5.4	5.2	4.7	4.5
	9.0	7.9	5.8	5.8	5.6	5.4	5.2	4.7	4.5
11.0	9.8	6.0	6.0	5.6	5.4	5.2	4.7	4.5	
13.0	11.8	6.3	6.0	5.6	5.4	5.2	4.7	4.5	
15.0	13.7	6.5	6.0	5.6	5.4	5.2	4.7	4.5	

# DC INVERTER MULTI VRF INDOOR UNIT TECHNICAL SALES GUIDE

Capacity Index	Outdoor temperature		Indoor temperature °C DB						
			16.0	18.0	20.0	21.0	22.0	24.0	26.0
	°C DB	°C WB	TC	TC	TC	TC	TC	TC	TC
56	-19.7	-20	3.5	3.5	3.5	3.5	3.5	3.5	3.5
	-14.7	-15.0	4.0	4.0	4.0	4.0	4.0	4.0	3.9
	-12.6	-13.0	4.3	4.3	4.3	4.3	4.3	4.3	4.1
	-10.5	-11.0	4.5	4.5	4.5	4.5	4.5	4.5	4.4
	-9.5	-10.0	4.5	4.5	4.5	4.5	4.5	4.5	4.4
	-8.5	-9.1	4.8	4.8	4.8	4.8	4.8	4.8	4.6
	-7.0	-7.6	4.8	4.8	4.8	4.8	4.8	4.8	4.6
	-5.0	-5.6	5.0	5.0	5.0	5.0	5.0	5.0	5.0
	-3.0	-3.7	5.3	5.3	5.3	5.3	5.3	5.3	5.0
	0.0	-0.7	5.5	5.5	5.5	5.5	5.5	5.3	5.0
	3.0	2.2	6.0	6.0	6.0	6.0	5.8	5.3	5.0
	5.0	4.1	6.0	6.0	6.0	6.0	5.8	5.3	5.0
	7.0	6.0	6.3	6.3	6.3	6.0	5.8	5.3	5.0
	9.0	7.9	6.6	6.6	6.3	6.0	5.8	5.3	5.0
11.0	9.8	6.8	6.8	6.3	6.0	5.8	5.3	5.0	
13.0	11.8	7.1	6.8	6.3	6.0	5.8	5.3	5.0	
15.0	13.7	7.3	6.8	6.3	6.0	5.8	5.3	5.0	
63	-19.7	-20	4.0	4.0	4.0	4.0	4.0	4.0	3.9
	-14.7	-15.0	4.5	4.5	4.5	4.5	4.5	4.5	4.4
	-12.6	-13.0	4.8	4.8	4.8	4.8	4.8	4.8	4.7
	-10.5	-11.0	5.1	5.1	5.1	5.1	5.1	5.1	5.0
	-9.5	-10.0	5.1	5.1	5.1	5.1	5.1	5.1	5.0
	-8.5	-9.1	5.4	5.4	5.4	5.4	5.4	5.4	5.2
	-7.0	-7.6	5.4	5.4	5.4	5.4	5.4	5.4	5.2
	-5.0	-5.6	5.7	5.7	5.7	5.7	5.7	5.7	5.7
	-3.0	-3.7	6.0	6.0	6.0	6.0	6.0	6.0	5.7
	0.0	-0.7	6.2	6.2	6.2	6.2	6.2	6.0	5.7
	3.0	2.2	6.8	6.8	6.8	6.8	6.5	6.0	5.7
	5.0	4.1	6.8	6.8	6.8	6.8	6.5	6.0	5.7
	7.0	6.0	7.1	7.1	7.1	6.8	6.5	6.0	5.7
	9.0	7.9	7.4	7.4	7.1	6.8	6.5	6.0	5.7
11.0	9.8	7.7	7.7	7.1	6.8	6.5	6.0	5.7	
13.0	11.8	8.0	7.7	7.1	6.8	6.5	6.0	5.7	
15.0	13.7	8.2	7.7	7.1	6.8	6.5	6.0	5.7	



Capacity Index	Outdoor temperature		Indoor temperature °C DB						
			16.0	18.0	20.0	21.0	22.0	24.0	26.0
	°C DB	°C WB	TC	TC	TC	TC	TC	TC	TC
71	-19.7	-20	4.5	4.5	4.5	4.5	4.5	4.5	4.4
	-14.7	-15.0	5.1	5.1	5.1	5.1	5.1	5.1	5.0
	-12.6	-13.0	5.4	5.4	5.4	5.4	5.4	5.4	5.2
	-10.5	-11.0	5.8	5.8	5.8	5.8	5.8	5.8	5.6
	-9.5	-10.0	5.8	5.8	5.8	5.8	5.8	5.8	5.6
	-8.5	-9.1	6.1	6.1	6.1	6.1	6.1	6.1	5.9
	-7.0	-7.6	6.1	6.1	6.1	6.1	6.1	6.1	5.9
	-5.0	-5.6	6.4	6.4	6.4	6.4	6.4	6.4	6.4
	-3.0	-3.7	6.7	6.7	6.7	6.7	6.7	6.7	6.4
	0.0	-0.7	7.0	7.0	7.0	7.0	7.0	6.7	6.4
	3.0	2.2	7.7	7.7	7.7	7.7	7.4	6.7	6.4
	5.0	4.1	7.7	7.7	7.7	7.7	7.4	6.7	6.4
	7.0	6.0	8.0	8.0	8.0	7.7	7.4	6.7	6.4
	9.0	7.9	8.3	8.3	8.0	7.7	7.4	6.7	6.4
11.0	9.8	8.6	8.6	8.0	7.7	7.4	6.7	6.4	
13.0	11.8	9.0	8.6	8.0	7.7	7.4	6.7	6.4	
15.0	13.7	9.2	8.6	8.0	7.7	7.4	6.7	6.4	
80	-19.7	-20	4.9	4.9	4.9	4.9	4.9	4.9	4.9
	-14.7	-15.0	5.6	5.6	5.6	5.6	5.6	5.6	5.5
	-12.6	-13.0	6.0	6.0	6.0	6.0	6.0	6.0	5.8
	-10.5	-11.0	6.3	6.3	6.3	6.3	6.3	6.3	6.2
	-9.5	-10.0	6.3	6.3	6.3	6.3	6.3	6.3	6.2
	-8.5	-9.1	6.7	6.7	6.7	6.7	6.7	6.7	6.5
	-7.0	-7.6	6.7	6.7	6.7	6.7	6.7	6.7	6.5
	-5.0	-5.6	7.0	7.0	7.0	7.0	7.0	7.0	7.0
	-3.0	-3.7	7.4	7.4	7.4	7.4	7.4	7.4	7.0
	0.0	-0.7	7.7	7.7	7.7	7.7	7.7	7.4	7.0
	3.0	2.2	8.4	8.4	8.4	8.4	8.1	7.4	7.0
	5.0	4.1	8.4	8.4	8.4	8.4	8.1	7.4	7.0
	7.0	6.0	8.8	8.8	8.8	8.4	8.1	7.4	7.0
	9.0	7.9	9.2	9.2	8.8	8.4	8.1	7.4	7.0
11.0	9.8	9.5	9.5	8.8	8.4	8.1	7.4	7.0	
13.0	11.8	9.9	9.5	8.8	8.4	8.1	7.4	7.0	
15.0	13.7	10.2	9.5	8.8	8.4	8.1	7.4	7.0	

# DC INVERTER MULTI VRF INDOOR UNIT TECHNICAL SALES GUIDE

Capacity Index	Outdoor temperature		Indoor temperature °C DB						
			16.0	18.0	20.0	21.0	22.0	24.0	26.0
	°C DB	°C WB	TC	TC	TC	TC	TC	TC	TC
90	-19.7	-20	5.6	5.6	5.6	5.6	5.6	5.6	5.5
	-14.7	-15.0	6.4	6.4	6.4	6.4	6.4	6.4	6.2
	-12.6	-13.0	6.8	6.8	6.8	6.8	6.8	6.8	6.6
	-10.5	-11.0	7.2	7.2	7.2	7.2	7.2	7.2	7.0
	-9.5	-10.0	7.2	7.2	7.2	7.2	7.2	7.2	7.0
	-8.5	-9.1	7.6	7.6	7.6	7.6	7.6	7.6	7.4
	-7.0	-7.6	7.6	7.6	7.6	7.6	7.6	7.6	7.4
	-5.0	-5.6	8.0	8.0	8.0	8.0	8.0	8.0	8.0
	-3.0	-3.7	8.4	8.4	8.4	8.4	8.4	8.4	8.0
	0.0	-0.7	8.8	8.8	8.8	8.8	8.8	8.4	8.0
	3.0	2.2	9.6	9.6	9.6	9.6	9.2	8.4	8.0
	5.0	4.1	9.6	9.6	9.6	9.6	9.2	8.4	8.0
	7.0	6.0	10.0	10.0	10.0	9.6	9.2	8.4	8.0
	9.0	7.9	10.4	10.4	10.0	9.6	9.2	8.4	8.0
	11.0	9.8	10.8	10.8	10.0	9.6	9.2	8.4	8.0
13.0	11.8	11.2	10.8	10.0	9.6	9.2	8.4	8.0	
15.0	13.7	11.6	10.8	10.0	9.6	9.2	8.4	8.0	
100	-19.7	-20	6.3	6.3	6.3	6.3	6.3	6.3	6.2
	-14.7	-15.0	7.2	7.2	7.2	7.2	7.2	7.2	7.0
	-12.6	-13.0	7.6	7.6	7.6	7.6	7.6	7.6	7.3
	-10.5	-11.0	8.1	8.1	8.1	8.1	8.1	8.1	7.9
	-9.5	-10.0	8.1	8.1	8.1	8.1	8.1	8.1	7.9
	-8.5	-9.1	8.5	8.5	8.5	8.5	8.5	8.5	8.2
	-7.0	-7.6	8.5	8.5	8.5	8.5	8.5	8.5	8.2
	-5.0	-5.6	9.0	9.0	9.0	9.0	9.0	9.0	9.0
	-3.0	-3.7	9.4	9.4	9.4	9.4	9.4	9.4	9.0
	0.0	-0.7	9.9	9.9	9.9	9.9	9.9	9.4	9.0
	3.0	2.2	10.8	10.8	10.8	10.8	10.3	9.4	9.0
	5.0	4.1	10.8	10.8	10.8	10.8	10.3	9.4	9.0
	7.0	6.0	11.2	11.2	11.2	10.8	10.3	9.4	9.0
	9.0	7.9	11.6	11.6	11.2	10.8	10.3	9.4	9.0
	11.0	9.8	12.1	12.1	11.2	10.8	10.3	9.4	9.0
13.0	11.8	12.6	12.1	11.2	10.8	10.3	9.4	9.0	
15.0	13.7	12.9	12.1	11.2	10.8	10.3	9.4	9.0	

Capacity Index	Outdoor temperature		Indoor temperature °C DB						
			16.0	18.0	20.0	21.0	22.0	24.0	26.0
	°C DB	°C WB	TC	TC	TC	TC	TC	TC	TC
112	-19.7	-20	7.0	7.0	7.0	7.0	7.0	7.0	6.9
	-14.7	-15.0	8.0	8.0	8.0	8.0	8.0	8.0	7.8
	-12.6	-13.0	8.5	8.5	8.5	8.5	8.5	8.5	8.2
	-10.5	-11.0	9.0	9.0	9.0	9.0	9.0	9.0	8.8
	-9.5	-10.0	9.0	9.0	9.0	9.0	9.0	9.0	8.8
	-8.5	-9.1	9.5	9.5	9.5	9.5	9.5	9.5	9.2
	-7.0	-7.6	9.5	9.5	9.5	9.5	9.5	9.5	9.2
	-5.0	-5.6	10.0	10.0	10.0	10.0	10.0	10.0	10.0
	-3.0	-3.7	10.5	10.5	10.5	10.5	10.5	10.5	10.0
	0.0	-0.7	11.0	11.0	11.0	11.0	11.0	10.5	10.0
	3.0	2.2	12.0	12.0	12.0	12.0	11.5	10.5	10.0
	5.0	4.1	12.0	12.0	12.0	12.0	11.5	10.5	10.0
	7.0	6.0	12.5	12.5	12.5	12.0	11.5	10.5	10.0
	9.0	7.9	13.0	13.0	12.5	12.0	11.5	10.5	10.0
	11.0	9.8	13.5	13.5	12.5	12.0	11.5	10.5	10.0
13.0	11.8	14.0	13.5	12.5	12.0	11.5	10.5	10.0	
15.0	13.7	14.5	13.5	12.5	12.0	11.5	10.5	10.0	
125	-19.7	-20	7.8	7.8	7.8	7.8	7.8	7.8	7.7
	-14.7	-15.0	9.0	9.0	9.0	9.0	9.0	9.0	8.7
	-12.6	-13.0	9.5	9.5	9.5	9.5	9.5	9.5	9.2
	-10.5	-11.0	10.1	10.1	10.1	10.1	10.1	10.1	9.9
	-9.5	-10.0	10.1	10.1	10.1	10.1	10.1	10.1	9.8
	-8.5	-9.1	10.6	10.6	10.6	10.6	10.6	10.6	10.3
	-7.0	-7.6	10.6	10.6	10.6	10.6	10.6	10.6	10.3
	-5.0	-5.6	11.2	11.2	11.2	11.2	11.2	11.2	11.2
	-3.0	-3.7	11.8	11.8	11.8	11.8	11.8	11.8	11.2
	0.0	-0.7	12.3	12.3	12.3	12.3	12.3	11.8	11.2
	3.0	2.2	13.4	13.4	13.4	13.4	12.9	11.8	11.2
	5.0	4.1	13.4	13.4	13.4	13.4	12.9	11.8	11.2
	7.0	6.0	14.0	14.0	14.0	13.4	12.9	11.8	11.2
	9.0	7.9	14.6	14.6	14.0	13.4	12.9	11.8	11.2
	11.0	9.8	15.1	15.1	14.0	13.4	12.9	11.8	11.2
13.0	11.8	15.7	15.1	14.0	13.4	12.9	11.8	11.2	
15.0	13.7	16.2	15.1	14.0	13.4	12.9	11.8	11.2	

# DC INVERTER MULTI VRF INDOOR UNIT TECHNICAL SALES GUIDE

Capacity Index	Outdoor temperature		Indoor temperature °C DB						
			16.0	18.0	20.0	21.0	22.0	24.0	26.0
	°C DB	°C WB	TC	TC	TC	TC	TC	TC	TC
140	-19.7	-20	9.0	9.0	9.0	9.0	9.0	9.0	8.8
	-14.7	-15.0	10.2	10.2	10.2	10.2	10.2	10.2	10.0
	-12.6	-13.0	10.9	10.9	10.9	10.9	10.9	10.9	10.5
	-10.5	-11.0	11.5	11.5	11.5	11.5	11.5	11.5	11.3
	-9.5	-10.0	11.5	11.5	11.5	11.5	11.5	11.5	11.2
	-8.5	-9.1	12.2	12.2	12.2	12.2	12.2	12.2	11.8
	-7.0	-7.6	12.2	12.2	12.2	12.2	12.2	12.2	11.8
	-5.0	-5.6	12.8	12.8	12.8	12.8	12.8	12.8	12.8
	-3.0	-3.7	13.4	13.4	13.4	13.4	13.4	13.5	12.8
	0.0	-0.7	14.1	14.1	14.1	14.1	14.1	13.5	12.8
	3.0	2.2	15.4	15.4	15.4	15.4	14.8	13.5	12.8
	5.0	4.1	15.4	15.4	15.4	15.4	14.8	13.5	12.8
	7.0	6.0	16.0	16.0	16.0	15.4	14.8	13.5	12.8
	9.0	7.9	16.6	16.6	16.0	15.4	14.8	13.5	12.8
11.0	9.8	17.3	17.3	16.0	15.4	14.8	13.5	12.8	
13.0	11.8	18.0	17.3	16.0	15.4	14.8	13.5	12.8	
15.0	13.7	18.5	17.3	16.0	15.4	14.8	13.5	12.8	
160	-19.7	-20	9.8	9.8	9.8	9.8	9.8	9.8	9.7
	-14.7	-15.0	11.2	11.2	11.2	11.2	11.2	11.2	10.9
	-12.6	-13.0	11.9	11.9	11.9	11.9	11.9	11.9	11.5
	-10.5	-11.0	12.6	12.6	12.6	12.6	12.6	12.6	12.3
	-9.5	-10.0	12.6	12.6	12.6	12.6	12.6	12.6	12.3
	-8.5	-9.1	13.3	13.3	13.3	13.3	13.3	13.3	12.9
	-7.0	-7.6	13.3	13.3	13.3	13.3	13.3	13.3	12.9
	-5.0	-5.6	14.0	14.0	14.0	14.0	14.0	14.0	14.0
	-3.0	-3.7	14.7	14.7	14.7	14.7	14.7	14.7	14.0
	0.0	-0.7	15.4	15.4	15.4	15.4	15.4	14.7	14.0
	3.0	2.2	16.8	16.8	16.8	16.8	16.1	14.7	14.0
	5.0	4.1	16.8	16.8	16.8	16.8	16.1	14.7	14.0
	7.0	6.0	17.5	17.5	17.5	16.8	16.1	14.7	14.0
	9.0	7.9	18.2	18.2	17.5	16.8	16.1	14.7	14.0
11.0	9.8	18.9	18.9	17.5	16.8	16.1	14.7	14.0	
13.0	11.8	19.7	18.9	17.5	16.8	16.1	14.7	14.0	
15.0	13.7	20.2	18.9	17.5	16.8	16.1	14.7	14.0	

Capacity Index	Outdoor temperature		Indoor temperature °C DB						
			16.0	18.0	20.0	21.0	22.0	24.0	26.0
	°C DB	°C WB	TC	TC	TC	TC	TC	TC	TC
180	-19.7	-20.0	11.2	11.2	11.2	11.2	11.2	11.2	11.0
	-14.7	-15.0	12.8	12.8	12.8	12.8	12.8	12.8	12.5
	-12.6	-13.0	13.6	13.6	13.6	13.6	13.6	13.6	13.1
	-10.5	-11.0	14.4	14.4	14.4	14.4	14.4	14.4	14.1
	-9.5	-10.0	14.4	14.4	14.4	14.4	14.4	14.4	14.0
	-8.5	-9.1	15.2	15.2	15.2	15.2	15.2	15.2	14.7
	-7.0	-7.6	15.2	15.2	15.2	15.2	15.2	15.2	14.7
	-5.0	-5.6	16.0	16.0	16.0	16.0	16.0	16.0	16.0
	-3.0	-3.7	16.8	16.8	16.8	16.8	16.8	16.8	16.0
	0.0	-0.7	17.6	17.6	17.6	17.6	17.6	16.8	16.0
	3.0	2.2	19.2	19.2	19.2	19.2	18.4	16.8	16.0
	5.0	4.1	19.2	19.2	19.2	19.2	18.4	16.8	16.0
	7.0	6.0	20.0	20.0	20.0	19.2	18.4	16.8	16.0
	9.0	7.9	20.8	20.8	20.0	19.2	18.4	16.8	16.0
	11.0	9.8	21.6	21.6	20.0	19.2	18.4	16.8	16.0
13.0	11.8	22.5	21.6	20.0	19.2	18.4	16.8	16.0	
15.0	13.7	23.1	21.6	20.0	19.2	18.4	16.8	16.0	
224	-19.7	-20	14.0	14.0	14.0	14.0	14.0	14.0	13.8
	-14.7	-15.0	16.0	16.0	16.0	16.0	16.0	16.0	15.6
	-12.6	-13.0	17.0	17.0	17.0	17.0	17.0	17.0	16.4
	-10.5	-11.0	18.0	18.0	18.0	18.0	18.0	18.0	17.6
	-9.5	-10.0	18.0	18.0	18.0	18.0	18.0	18.0	17.6
	-8.5	-9.1	19.0	19.0	19.0	19.0	19.0	19.0	18.4
	-7.0	-7.6	19.0	19.0	19.0	19.0	19.0	19.0	18.4
	-5.0	-5.6	20.0	20.0	20.0	20.0	20.0	20.0	20.0
	-3.0	-3.7	21.0	21.0	21.0	21.0	21.0	21.0	20.0
	0.0	-0.7	22.0	22.0	22.0	22.0	22.0	21.0	20.0
	3.0	2.2	24.0	24.0	24.0	24.0	23.1	21.0	20.0
	5.0	4.1	24.0	24.0	24.0	24.0	23.1	21.0	20.0
	7.0	6.0	25.0	25.0	25.0	24.0	23.1	21.0	20.0
	9.0	7.9	26.0	26.0	25.0	24.0	23.1	21.0	20.0
	11.0	9.8	27.0	27.0	25.0	24.0	23.1	21.0	20.0
13.0	11.8	28.1	27.0	25.0	24.0	23.1	21.0	20.0	
15.0	13.7	28.9	27.0	25.0	24.0	23.1	21.0	20.0	

Capacity Index	Outdoor temperature		Indoor temperature °C DB						
			16.0	18.0	20.0	21.0	22.0	24.0	26.0
	°C DB	°C WB	TC	TC	TC	TC	TC	TC	TC
280	-19.7	-20	17.4	17.4	17.4	17.4	17.4	17.4	17.1
	-14.7	-15.0	19.8	19.8	19.8	19.8	19.8	19.8	19.3
	-12.6	-13.0	21.1	21.1	21.1	21.1	21.1	21.1	20.3
	-10.5	-11.0	22.3	22.3	22.3	22.3	22.3	22.3	21.8
	-9.5	-10.0	22.3	22.3	22.3	22.3	22.3	22.3	21.8
	-8.5	-9.1	23.6	23.6	23.6	23.6	23.6	23.6	22.8
	-7.0	-7.6	23.6	23.6	23.6	23.6	23.6	23.6	22.8
	-5.0	-5.6	24.8	24.8	24.8	24.8	24.8	24.8	24.8
	-3.0	-3.7	26.0	26.0	26.0	26.0	26.0	26.1	24.8
	0.0	-0.7	27.3	27.3	27.3	27.3	27.3	26.1	24.8
	3.0	2.2	29.8	29.8	29.8	29.8	28.6	26.1	24.8
	5.0	4.1	29.8	29.8	29.8	29.8	28.6	26.1	24.8
	7.0	6.0	31.0	31.0	31.0	29.8	28.6	26.1	24.8
	9.0	7.9	32.2	32.2	31.0	29.8	28.6	26.1	24.8
	11.0	9.8	33.5	33.5	31.0	29.8	28.6	26.1	24.8
13.0	11.8	34.8	33.5	31.0	29.8	28.6	26.1	24.8	
15.0	13.7	35.8	33.5	31.0	29.8	28.6	26.1	24.8	

## 5 UNIT NOISE CURVES

### 5.1 General static pressure Duct Type GMV-ND\*\*PLS/C-T and GMV-ND\*\*PLS/C1-T

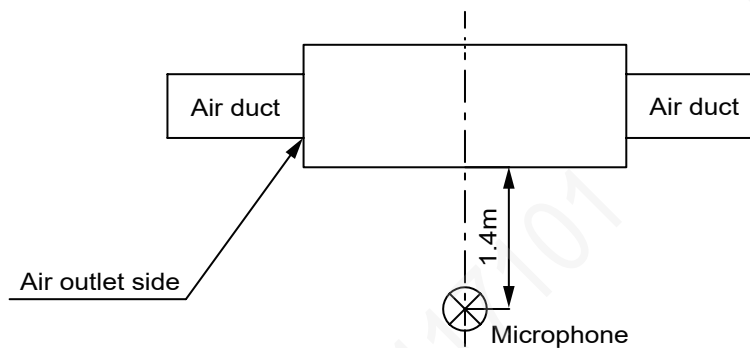

Notes:

- ① The noise level is measured in the semi-anechoic room. It will be slightly higher due to change of the environment during actual operation.
- ② The noise level is measured under the standard test condition.
- ③ The noise level is measured under the condition of rear air return. The noise level will be a little higher if the bottom air return mode is adopted.

Model GMV-ND18~28PLS/C-T, GMV-ND18~28PLS/C1-T

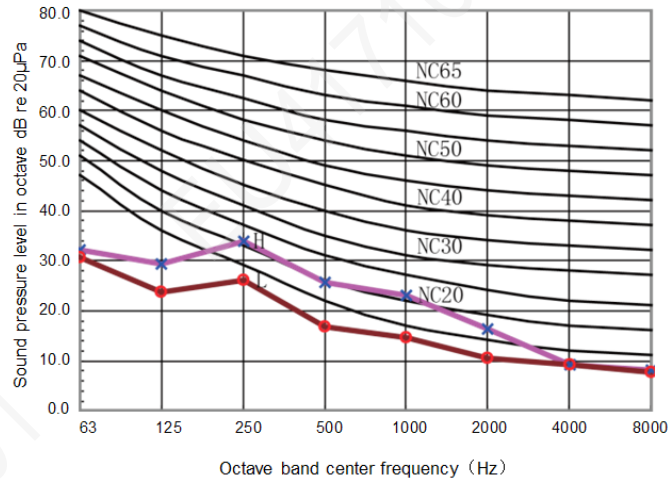

Model GMV-ND32~36PLS/C-T, GMV-ND32~36PLS/C1-T

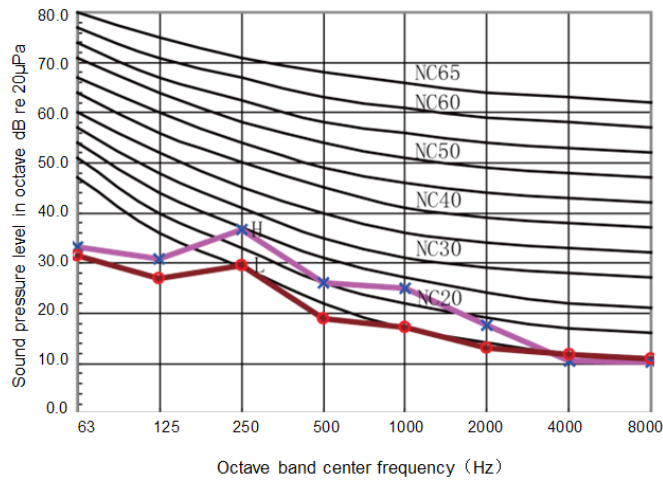

Model GMV-ND40~50PLS/C-T, GMV-ND40~50PLS/C1-T

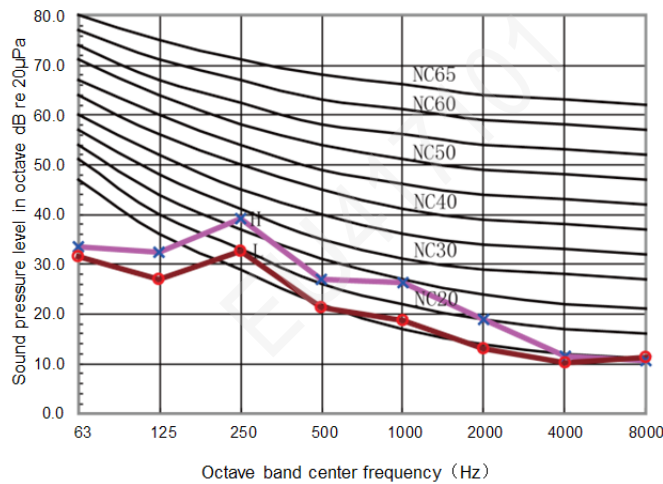



# DC INVERTER MULTI VRF INDOOR UNIT TECHNICAL SALES GUIDE

Model GMV-ND56~63PLS/C-T, GMV-ND56~63PLS/C1-T

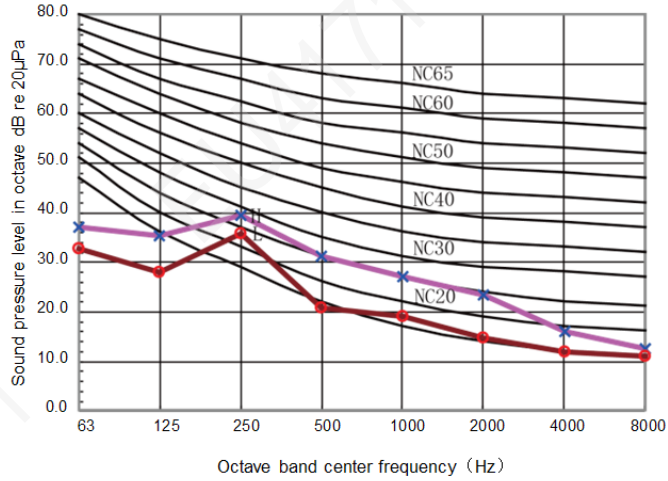

Model GMV-ND71PLS/C-T, GMV-ND71PLS/C1-T

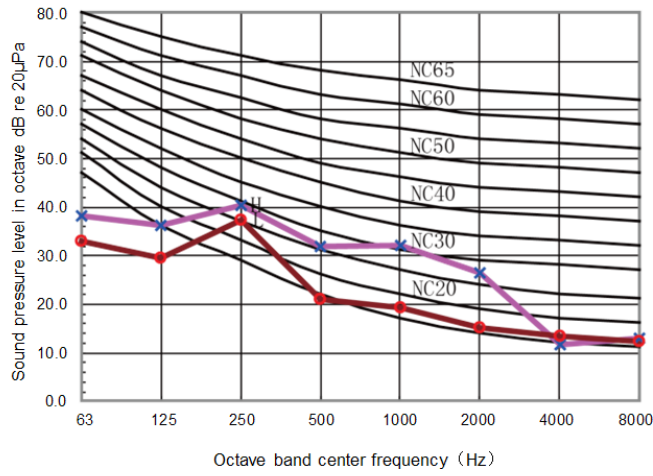

Model GMV-ND80PLS/C1-T

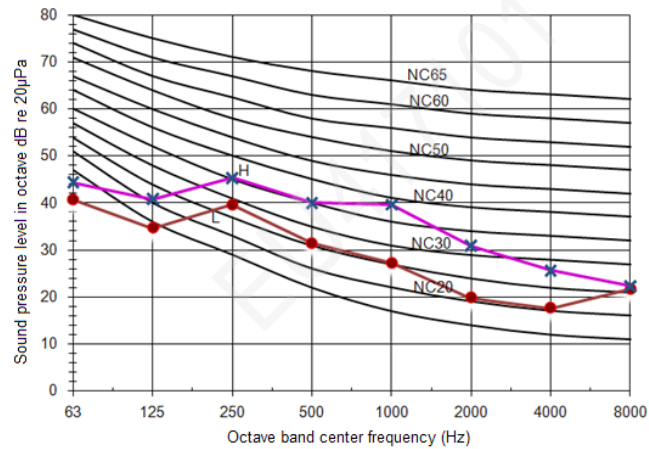

Model GMV-ND80PLS/C-T

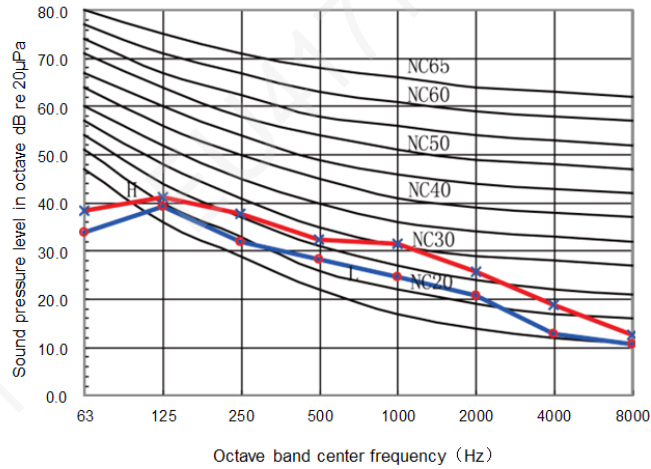

Model GMV-ND90~112PLS/C-T

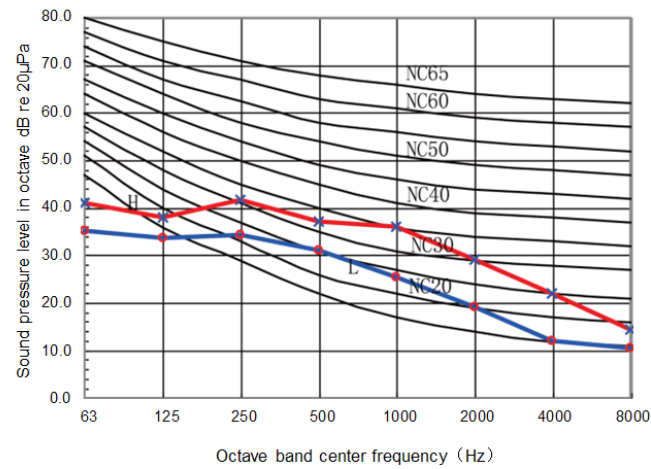

Model GMV-ND125~140PLS/C-T

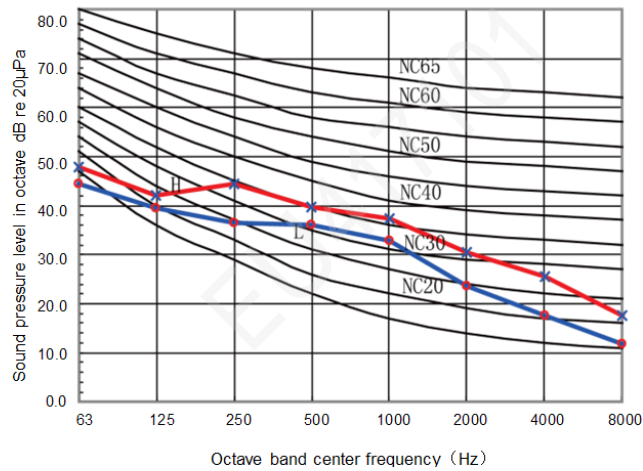

## 5.2 Four-way Cassette Type GMV-ND\*\*T/A-T

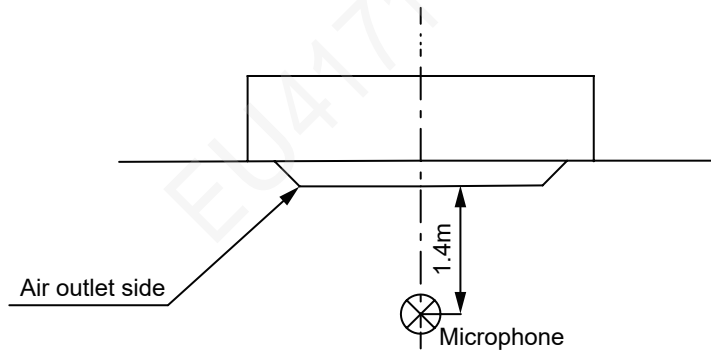

Notes:

- ① The noise level is measured in the semi-anechoic room. It will be slightly higher due to change of the environment during actual operation.
- ② The noise level is measured under the standard test condition.

Model 28-50

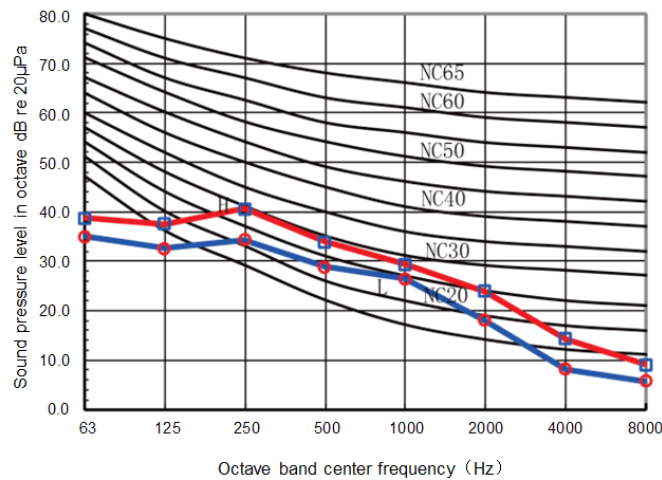

Model 56-63

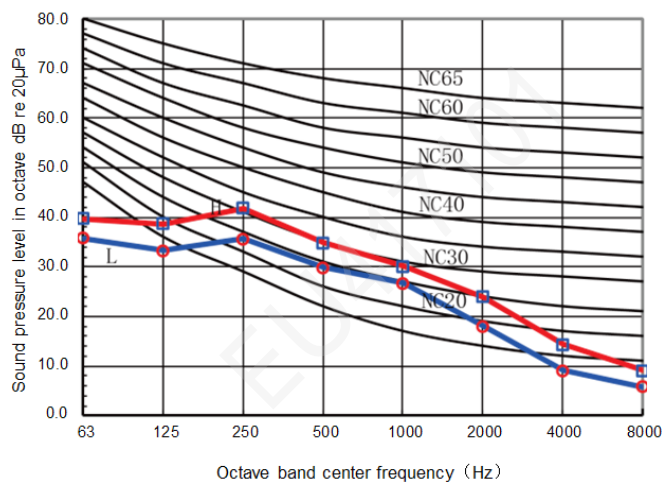

Model 71-80

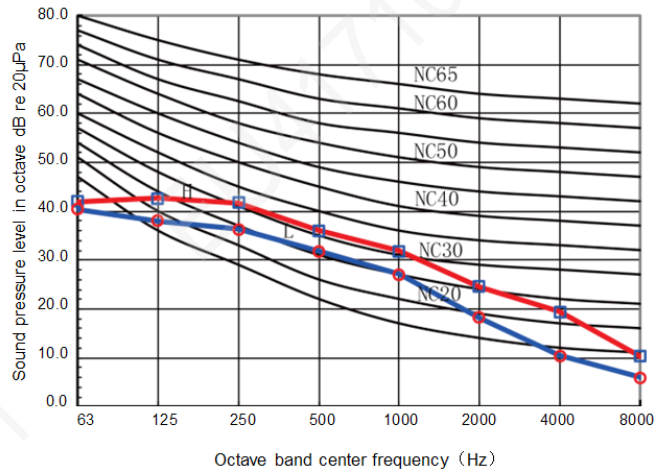

Model 90-100

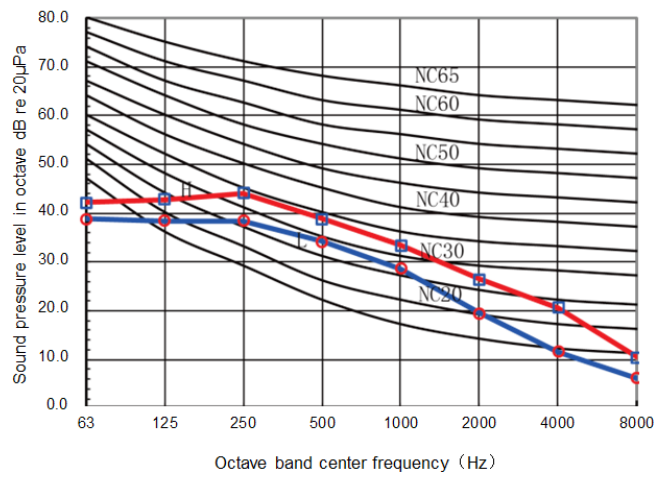

Model 112

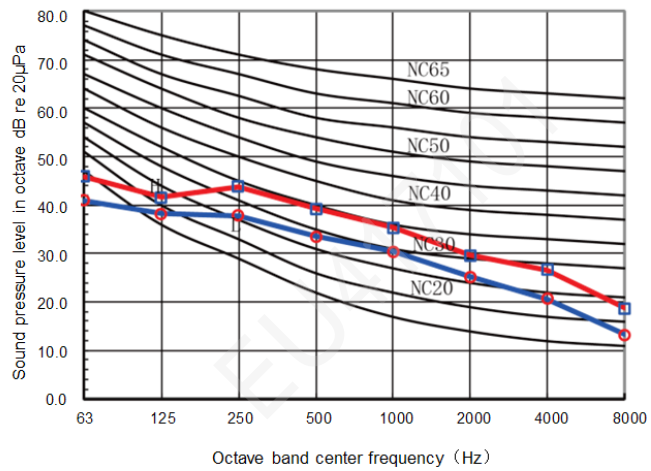

Model 125-140

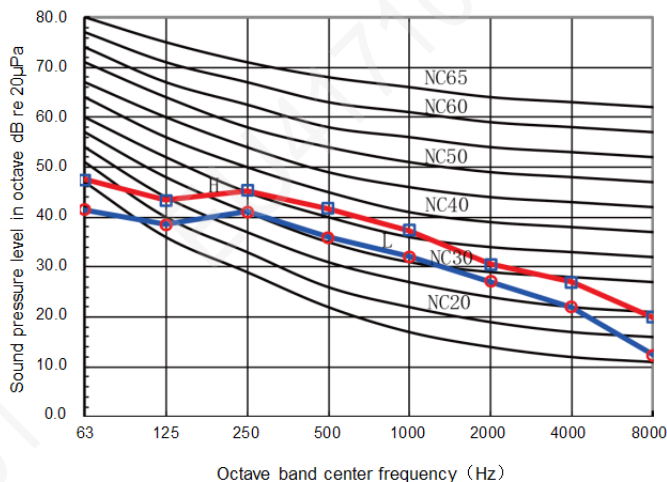

Model 160

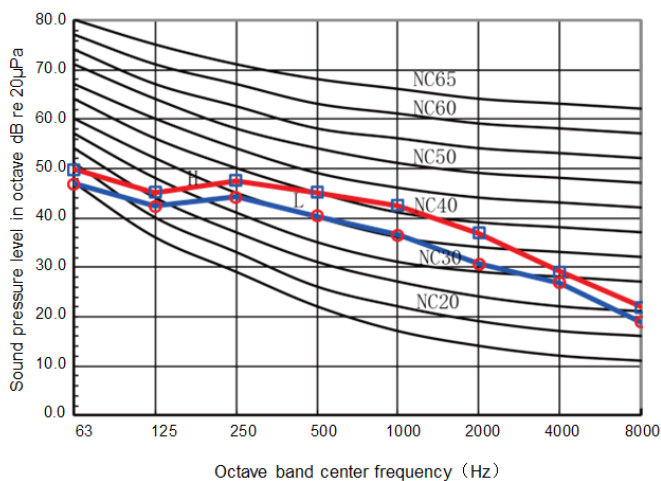

### 5.3 One-way Cassette Type GMV-ND\*\*TD/A-T

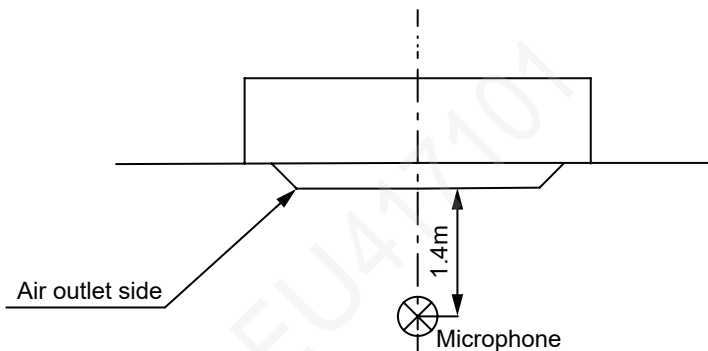

Notes:

- ① The noise level is measured in the semi-anechoic room. It will be slightly higher due to change of the environment during actual operation.
- ② The noise level is measured under the standard test condition.

**5.3.1 GMV-ND\*\*TD/A-T**

Model 22, 28

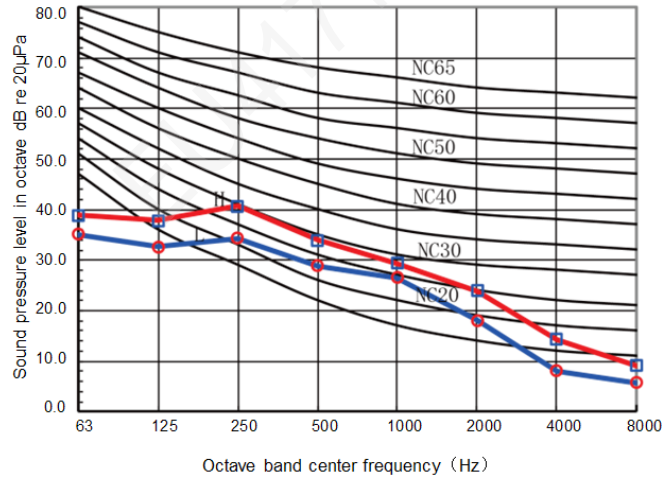

Model 36

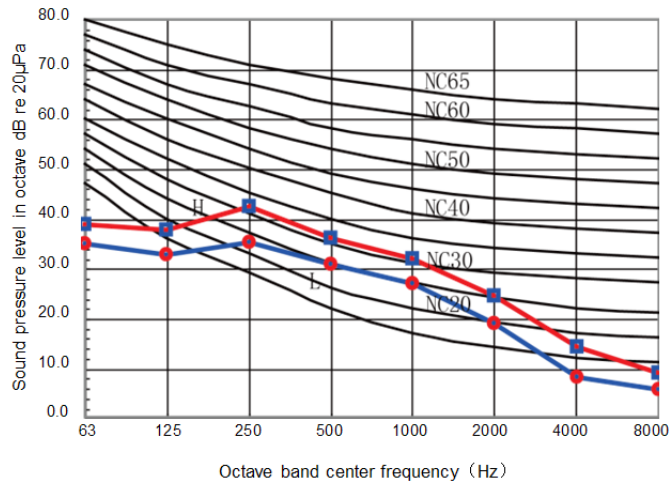

Model 45

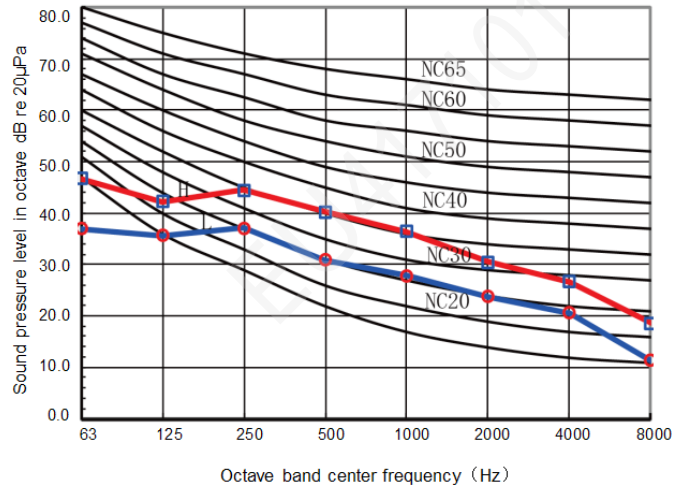



Model 50

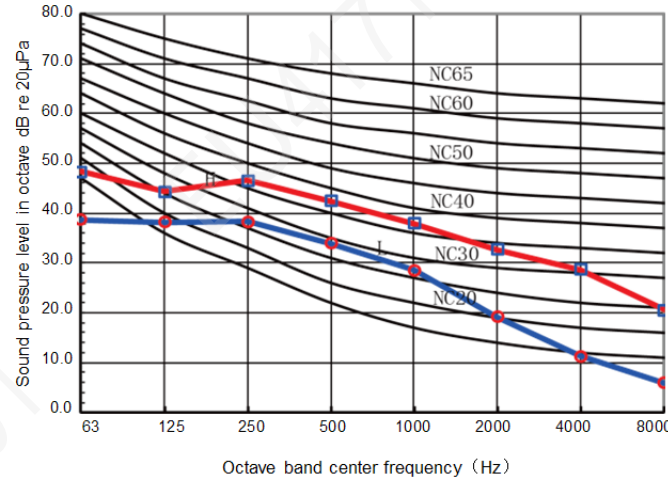

Model 56

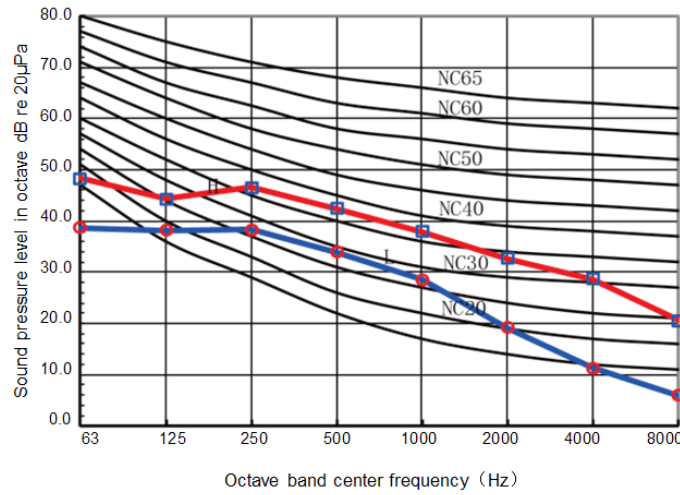

### 5.3.2 GMV-ND\*\*TD/B-T

Model 63

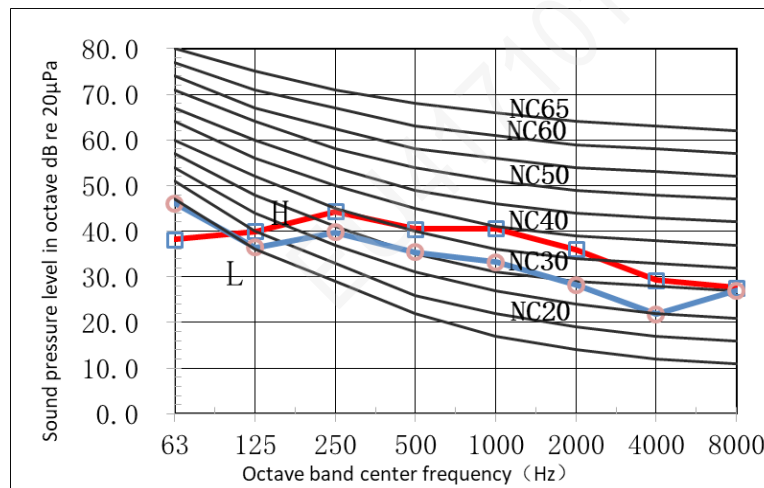



Model 71、80

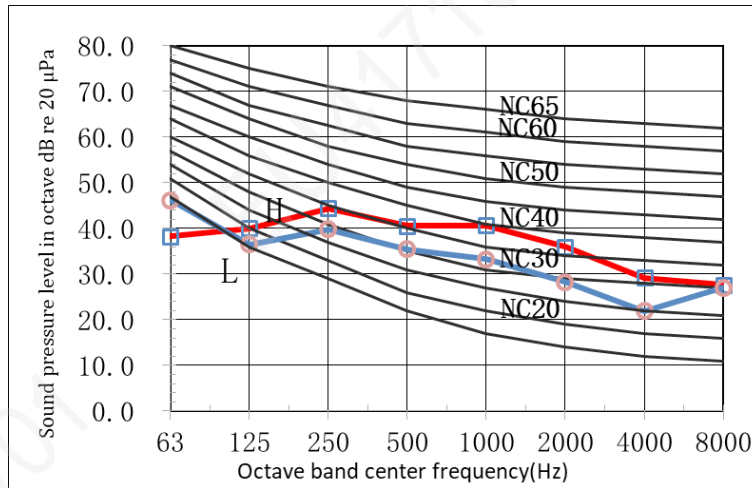

### 5.4 Floor Ceiling Type

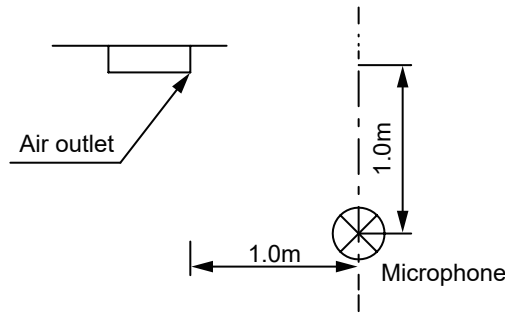

Notes:

- ① The noise level is measured in the semi-anechoic room. It will be slightly higher due to change of the environment during actual operation.
- ② The noise level is measured under the standard test condition.
- ③ The noise level is measured under the condition of ceiling installation.

#### 5.4.1 GMV-ND\*\*ZD/A-T

Model 28-36

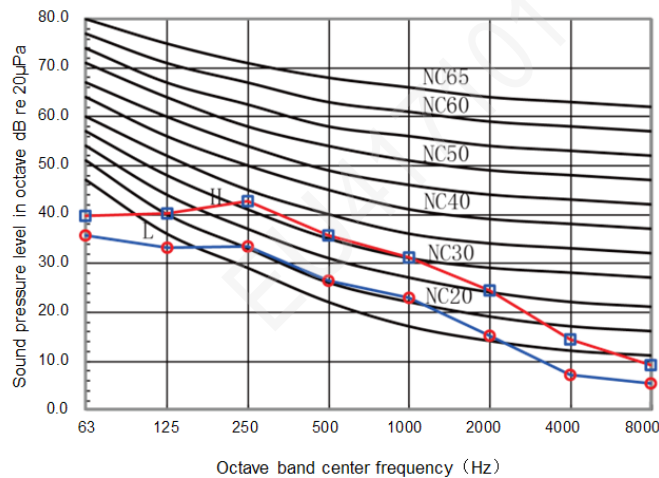

Model 50-56

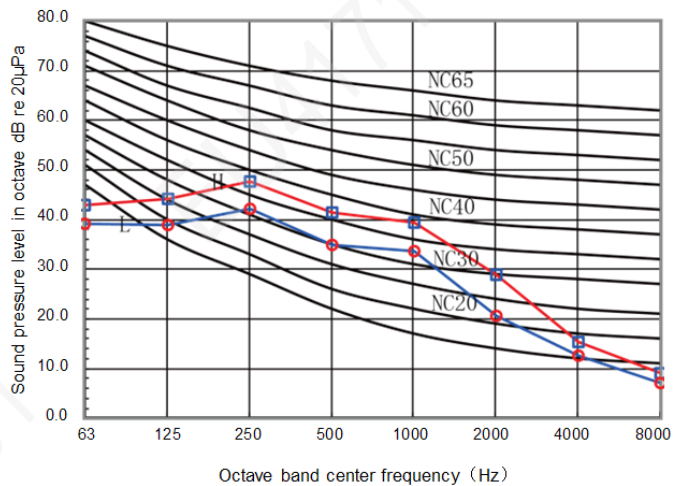

Model 63-71

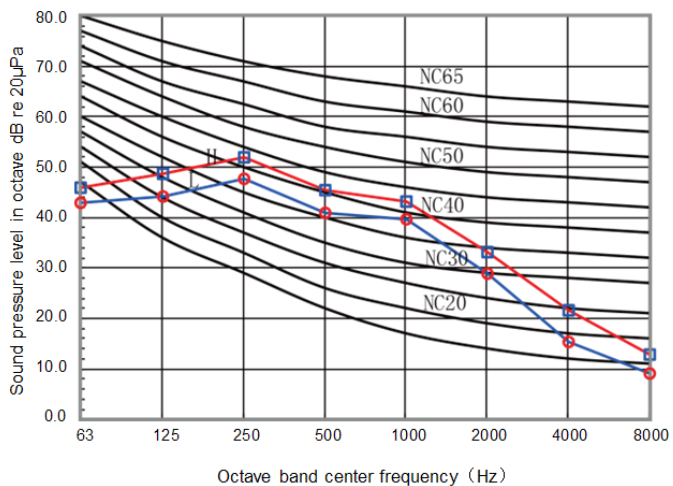

Model 90

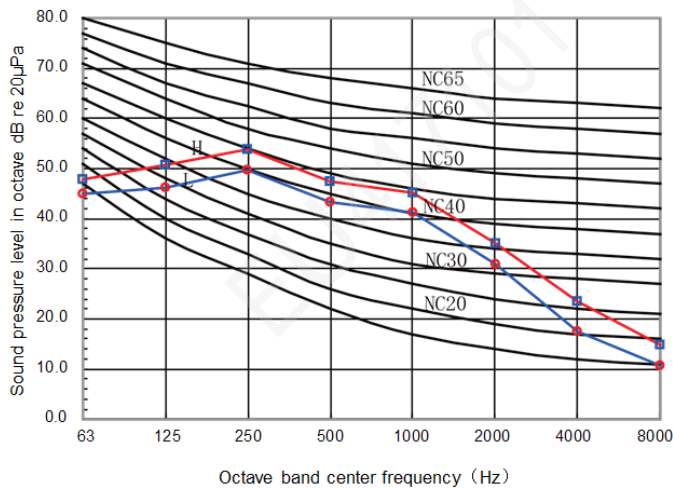

Model 112-160

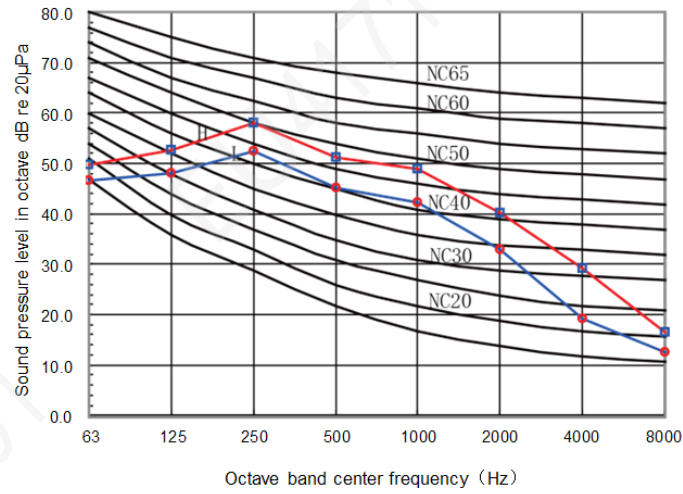

5.4.2 GMV-ND\*\*ZD/B-T

Model 28-36

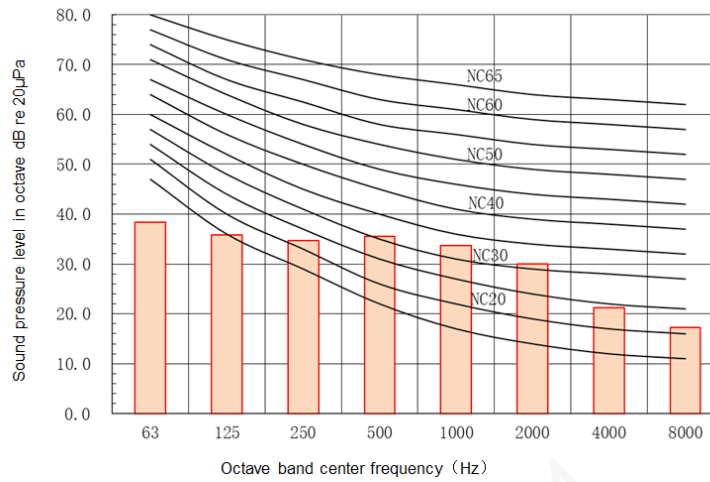

## Model 50-56

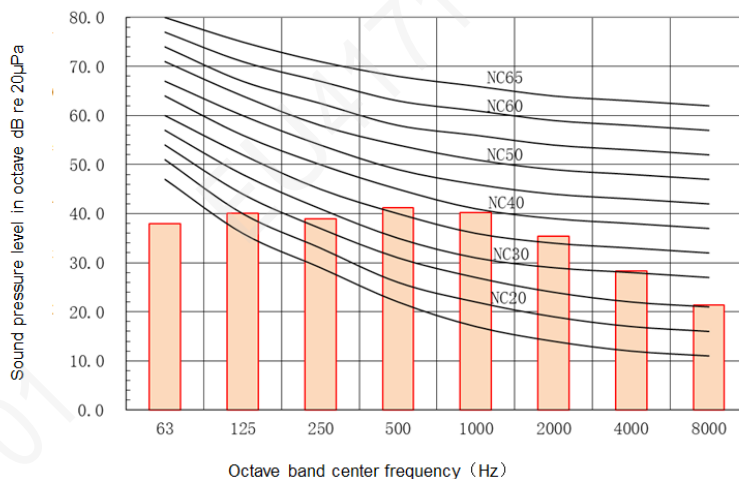

## Model 63-71

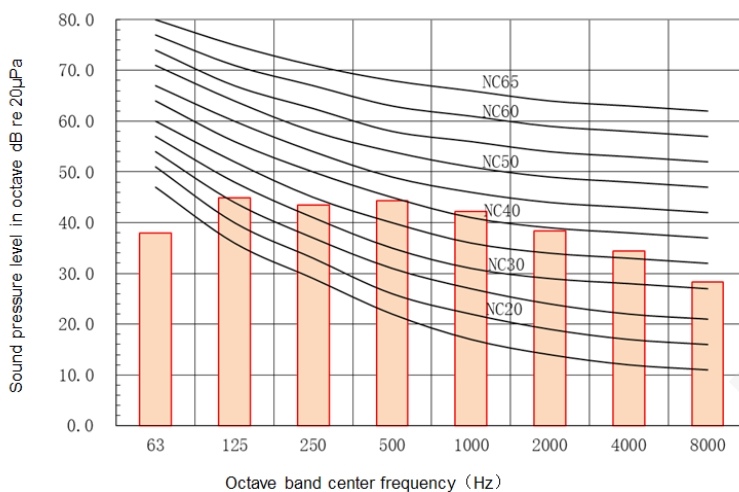

## Model 90

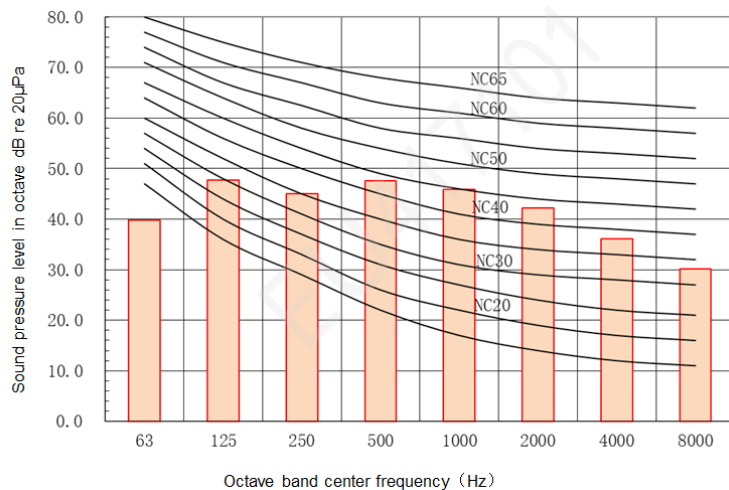

Model 112-125

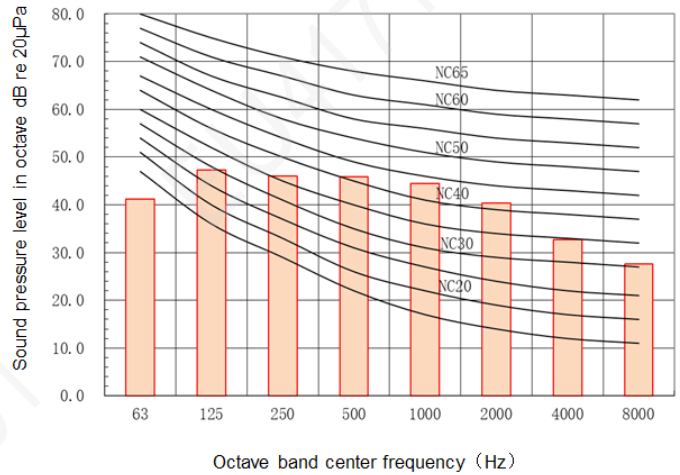

Model 140

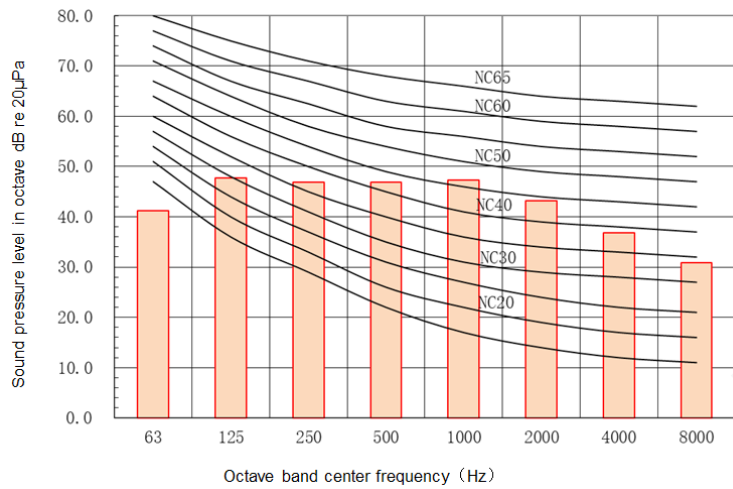

Model 160

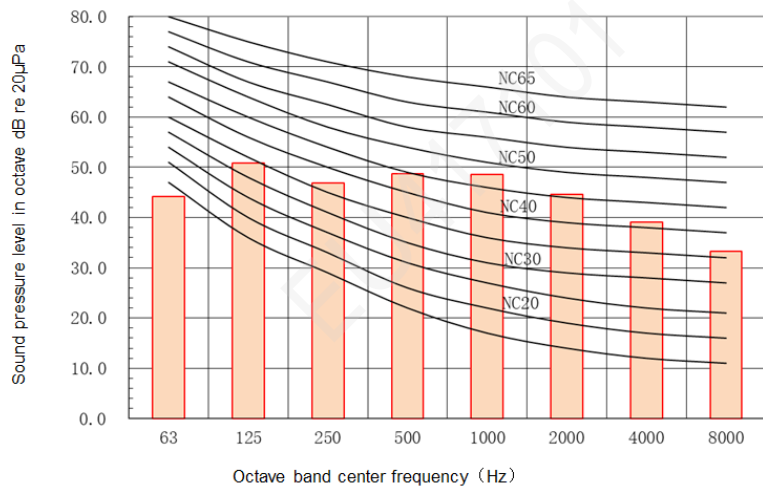

## 5.5 Slim Duct Type GMV-ND\*\*PL/B-T

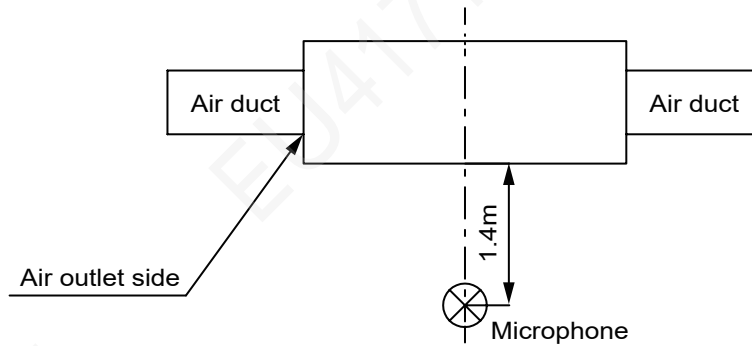

**Notes:**

- ① The noise level is measured in the semi-anechoic room. It will be slightly higher due to change of the environment during actual operation.
- ② The noise level is measured under the standard test condition.
- ③ The noise level is measured under the condition of rear air return. The noise level will be a little higher if the bottom air return mode is adopted.

Model GMV-ND22~28PL/B-T

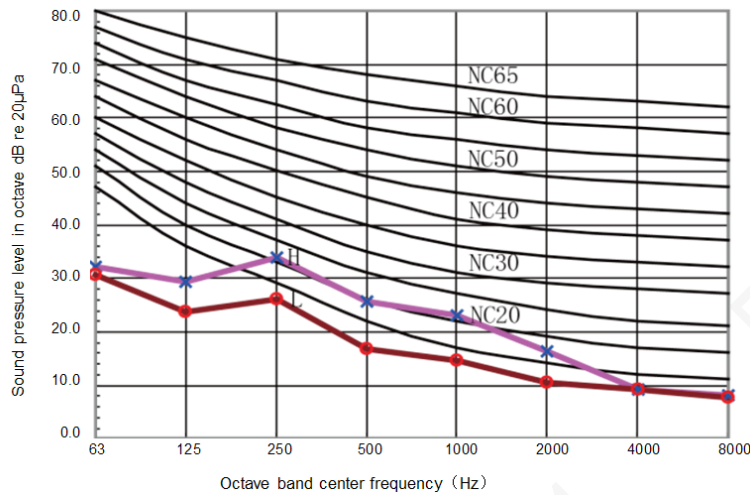

Model GMV-ND32~36PL/B-T

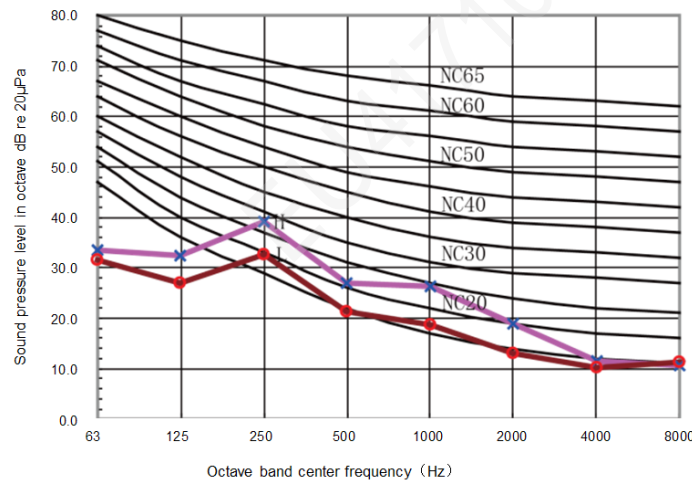

### Model GMV-ND40~50PL/B-T

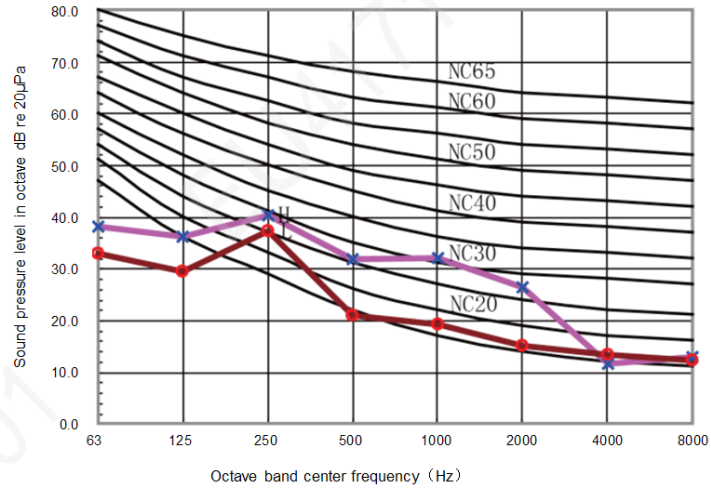

### Model GMV-ND56~63PL/B-T

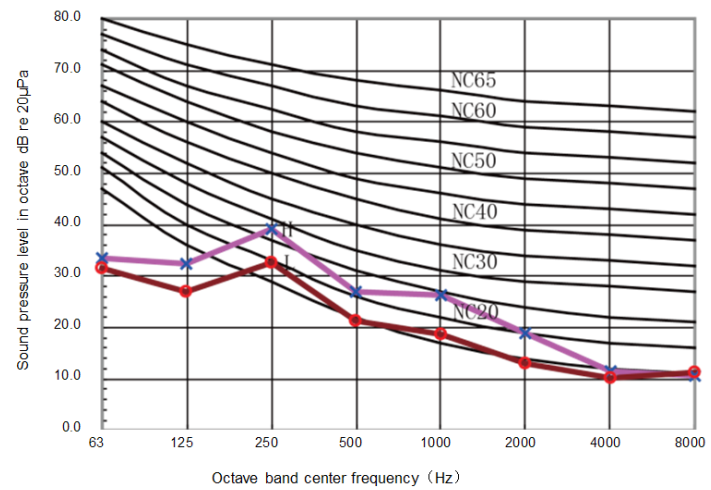

### Model GMV-ND72PL/B-T

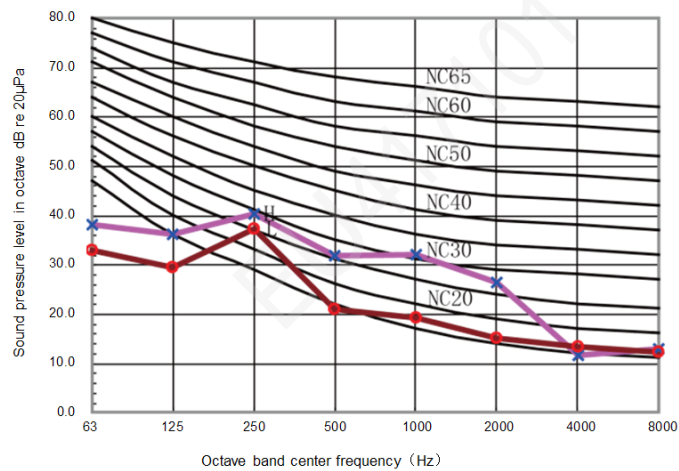



Model GMV-ND22~28PLS/B1-T

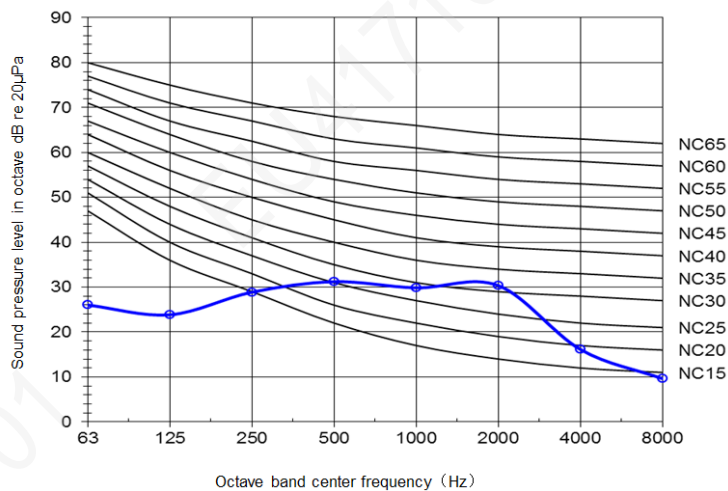

Model GMV-ND32~36PLS/B1-T

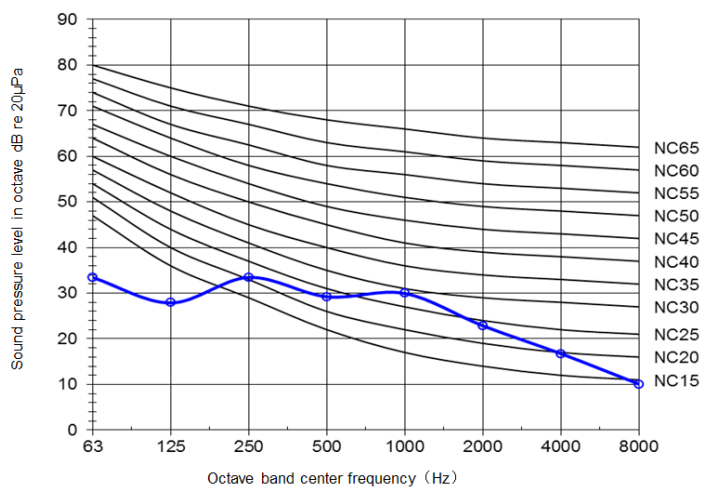

Model GMV-ND40~45PLS/B1-T

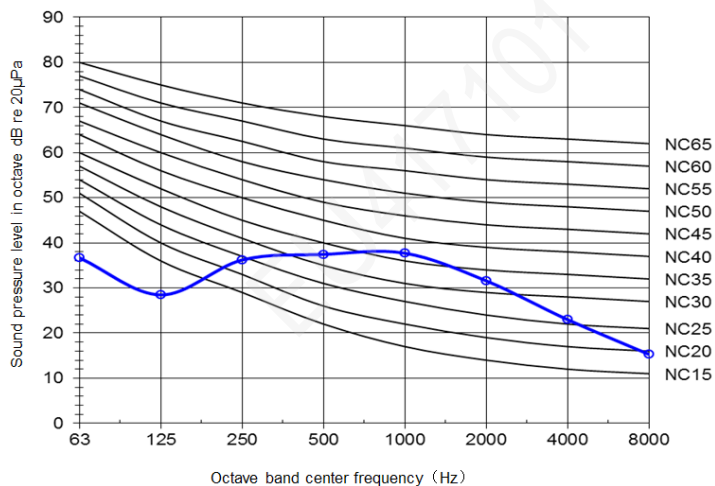

Model GMV-ND50~63PLS/B1-T

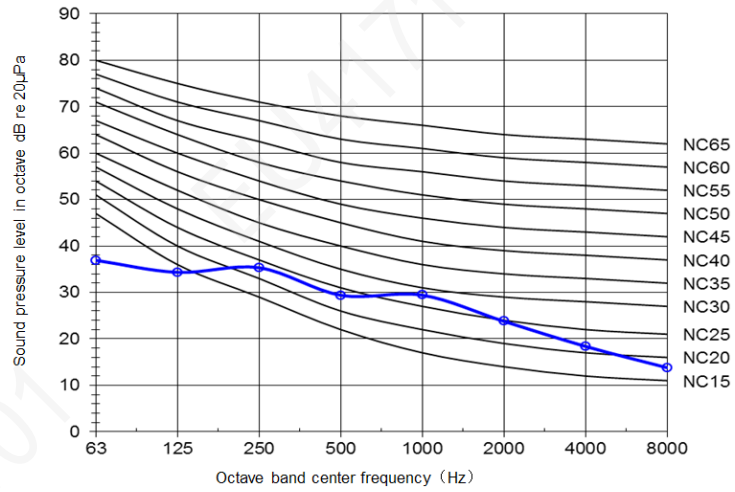

Model GMV-ND71PLS/B1-T

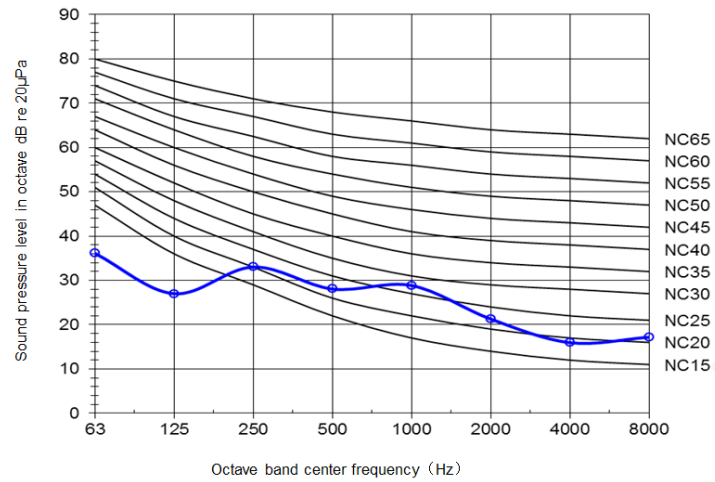

## 5.6 Wall Mounted Type

GMV-N\*\*G/A3A-K, GMV-N\*\*G/A2A-K, GMV-N\*\*G/A4A-K, GMV-N\*\*G/A8A-K, GMV-N\*\*G/C9A-K, GMV-N\*\*G/E3A-K, GMV-N\*\*G/B3A-K, GMV-N\*\*G/A3A-D, GMV-N\*\*G/A2A-D, GMV-N\*\*G/A4A-D, GMV-N\*\*G/A8A-D, GMV-N\*\*G/C9A-D, GMV-N\*\*G/E3A-D, GMV-N\*\*G/B3A-D, GMV-ND\*\*G/A3A-T, GMV-ND\*\*G/A8A-T, GMV-ND\*\*G/B4B-T, GMV-ND\*\*G/B6B-T, GMV-ND\*\*G/C2B-T, GMV-ND\*\*G/C4B-T, GMV-ND\*\*G/D2B-T

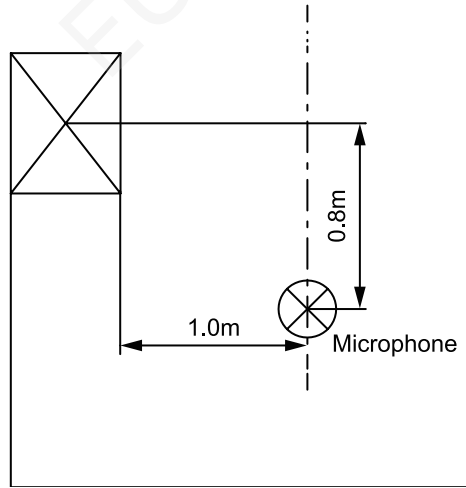

### Notes:

- ① The noise level is measured in the semi-anechoic room. It will be slightly higher due to change of the environment during actual operation.
- ② The noise level is measured under the standard test condition.

Model 15-28

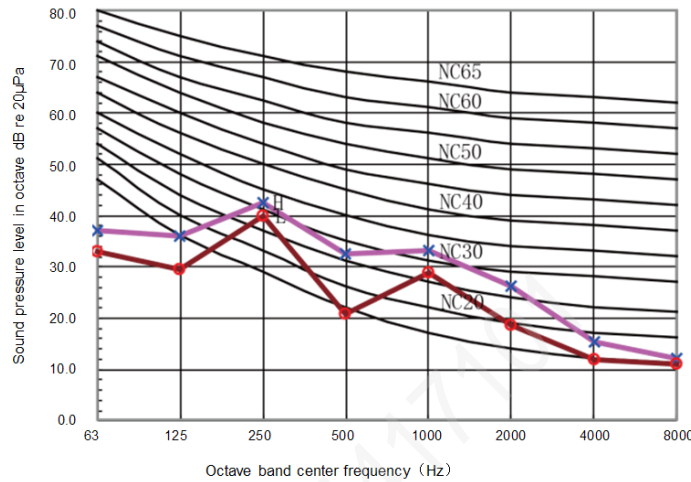

Model 36-50

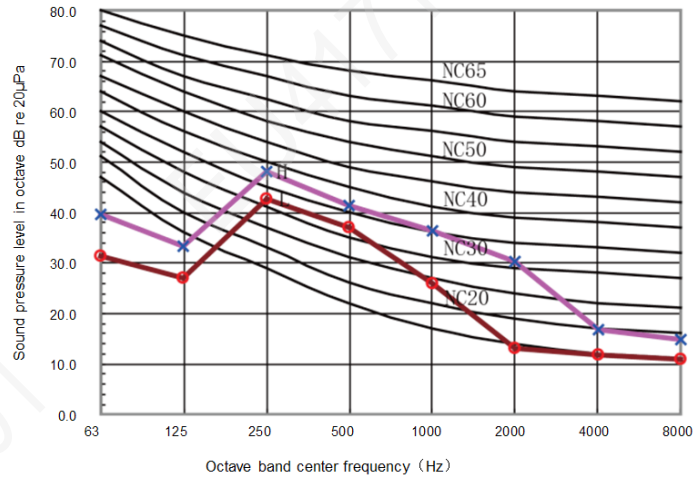

Model 56-71

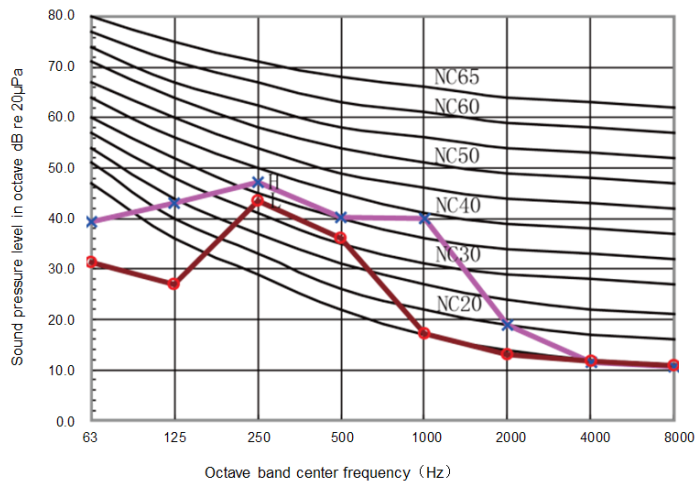

**5.7 Console Type(Floor and Wall Mounted Type) GMV-ND\*\*C/A-T**  
 Floor type

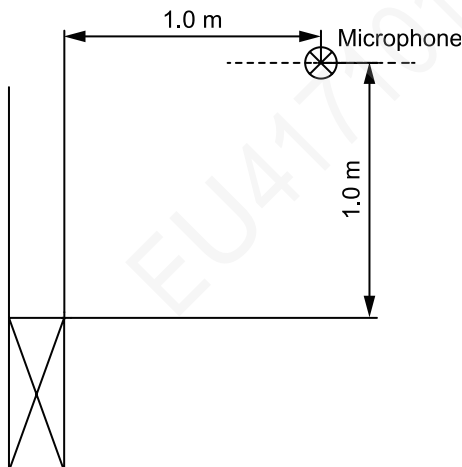

# DC INVERTER MULTI VRF INDOOR UNIT TECHNICAL SALES GUIDE

Wall Mounted type

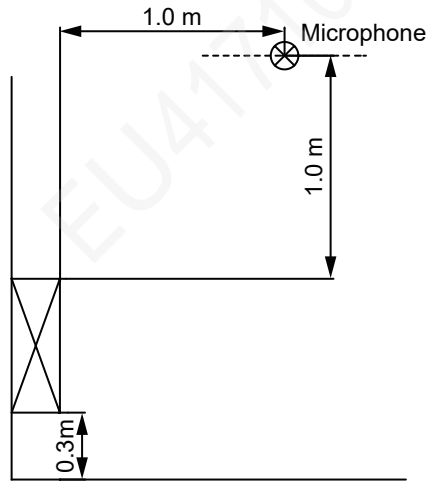

Model 22/28

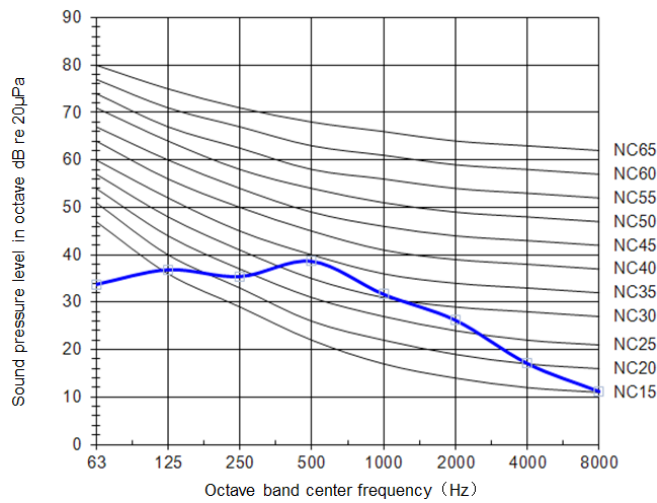

Model 36

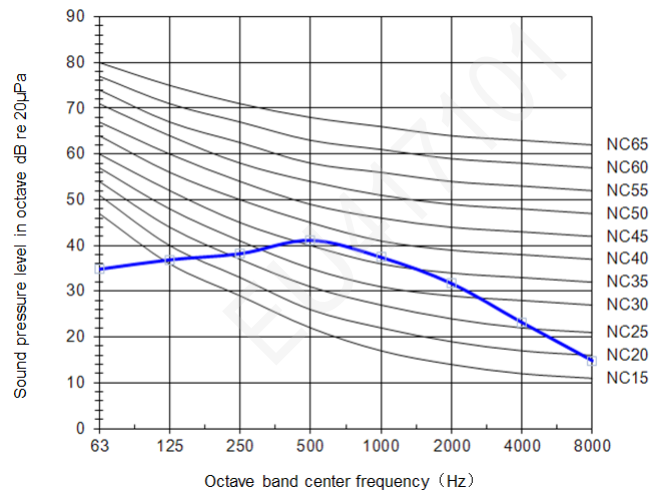

Model45/50

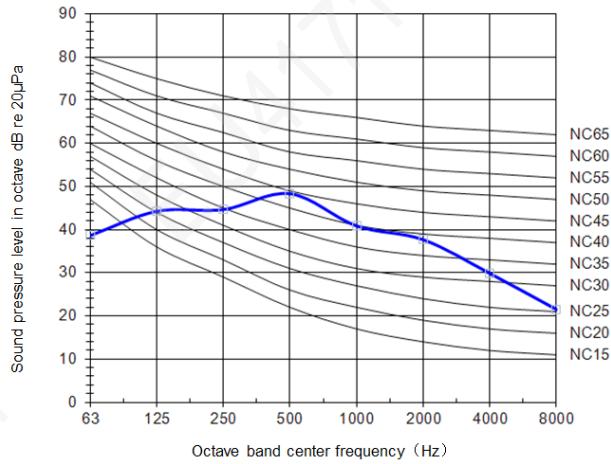

**5.8 Floor Standing Type GMV-ND\*\*L/A-T**

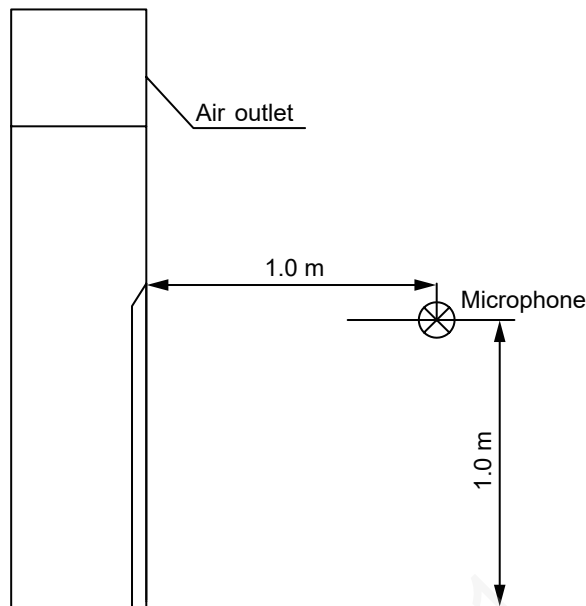

GMV-ND100L/A-T

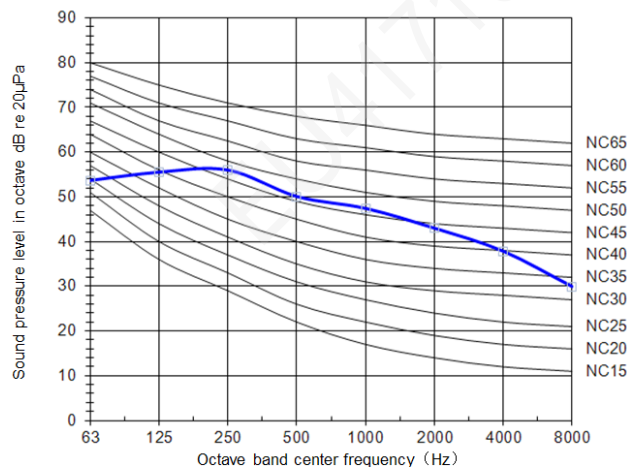

GMV-ND140L/A-T

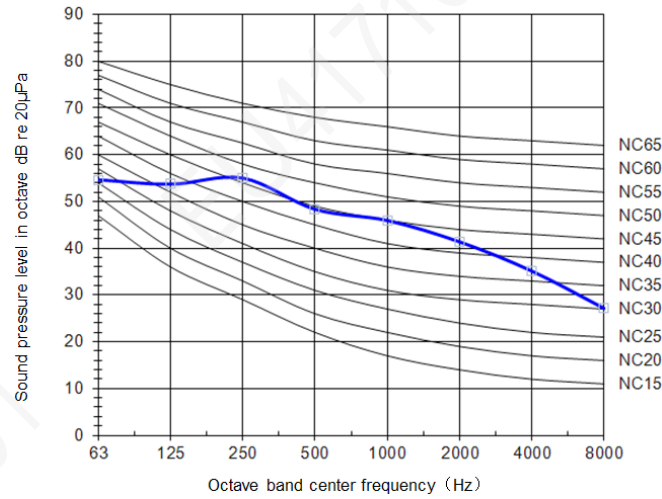

## 5.9 Compact Four-way Cassette Type GMV-ND\*\*T/B-T

Model 22-36

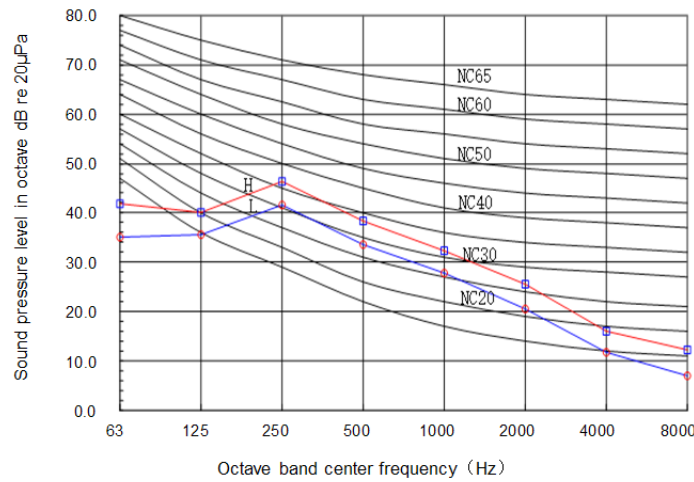

Model 45-56

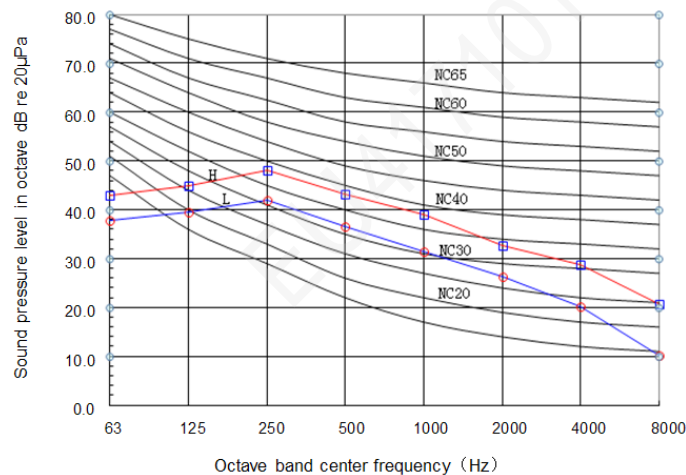



### 5.10 360° Air Discharge Compact Cassette Type GMV-ND\*\*T/E-T

Model 15-18

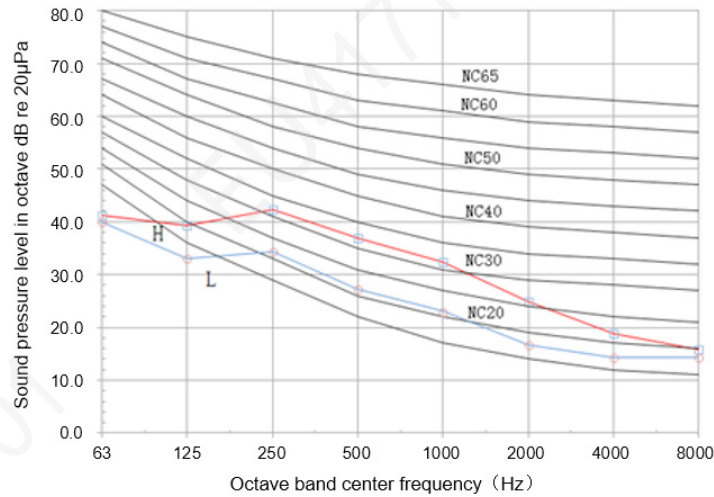

Model 22

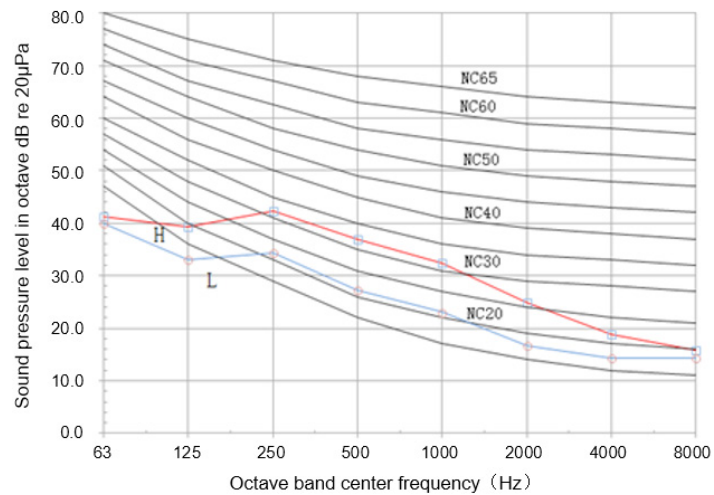

Model 28

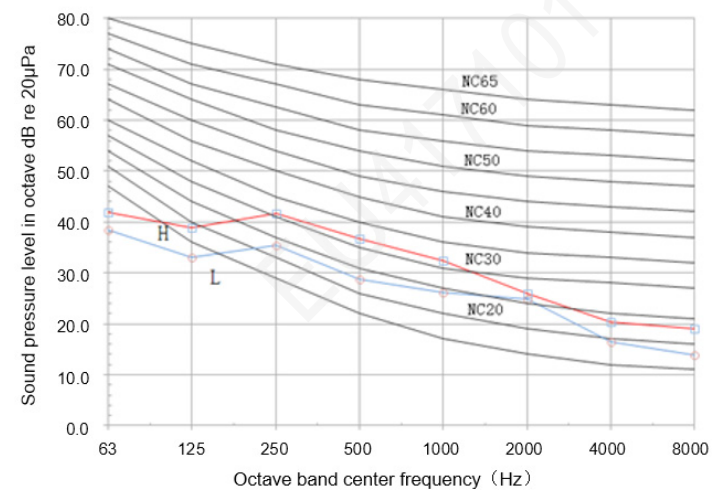

Model 36

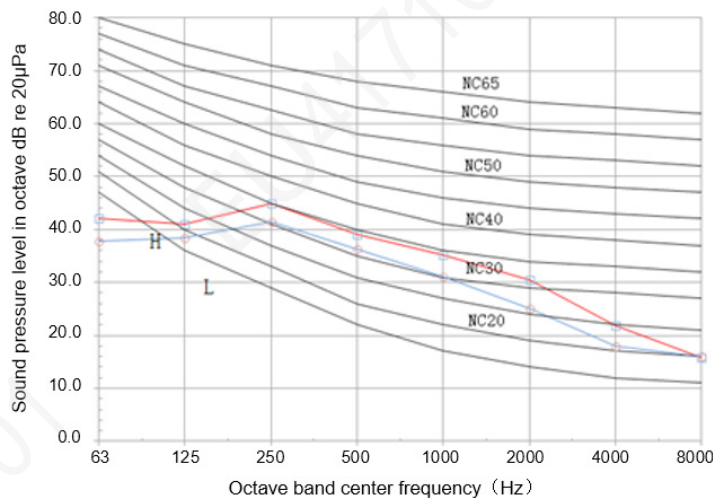

Model 45-56

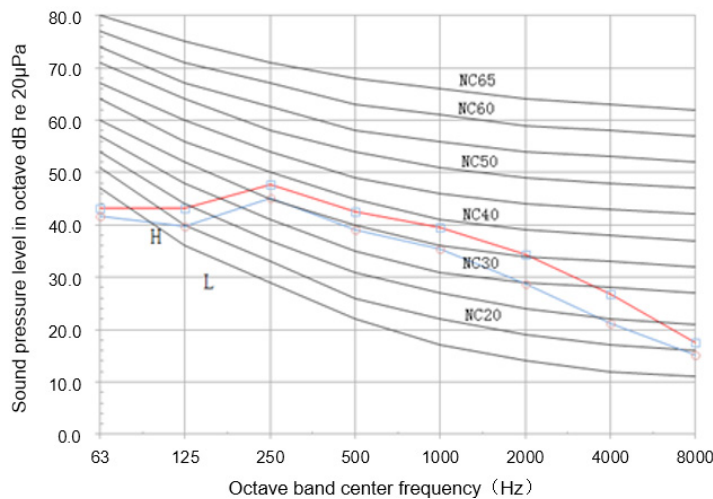

## 5.11 Two-way Cassette Type GMV-ND\*\*TS/A-T

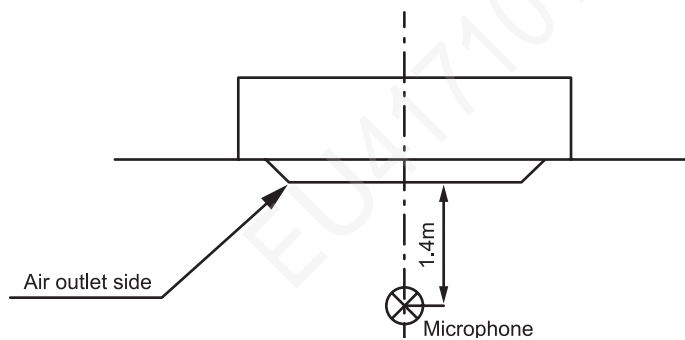

**Notes:**

- ① The noise level is measured in the semi-anechoic room. It will be slightly higher due to change of the environment during actual operation.
- ② The noise level is measured under the standard test condition.

**5.11.1 GMV-ND\*\*TS/A-T**

Model 28-50

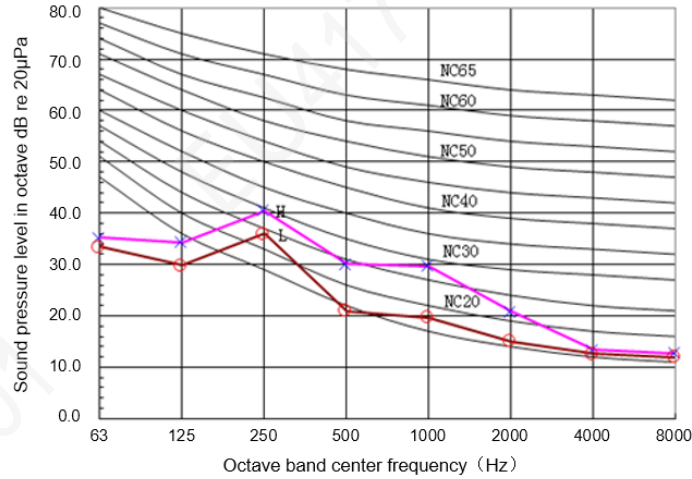

Model 56-71

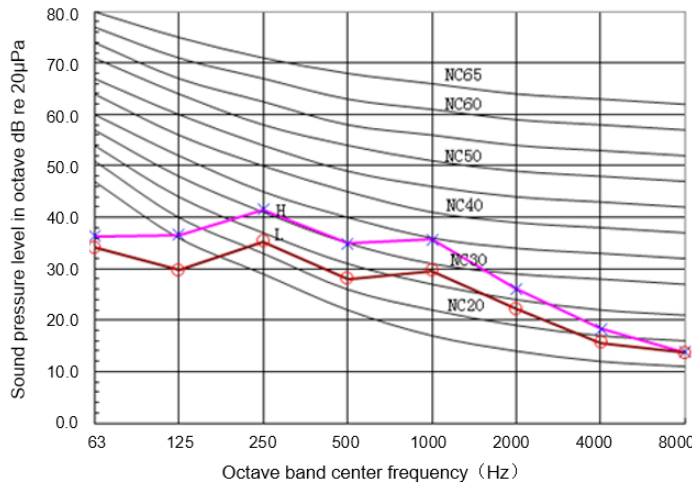

**5.11.2 GMV-ND\*\*TS/B-T**

Model 28-36

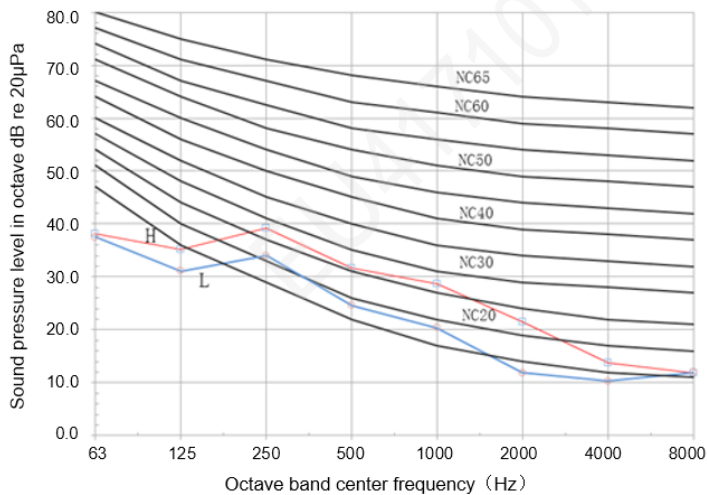

Model 45-50

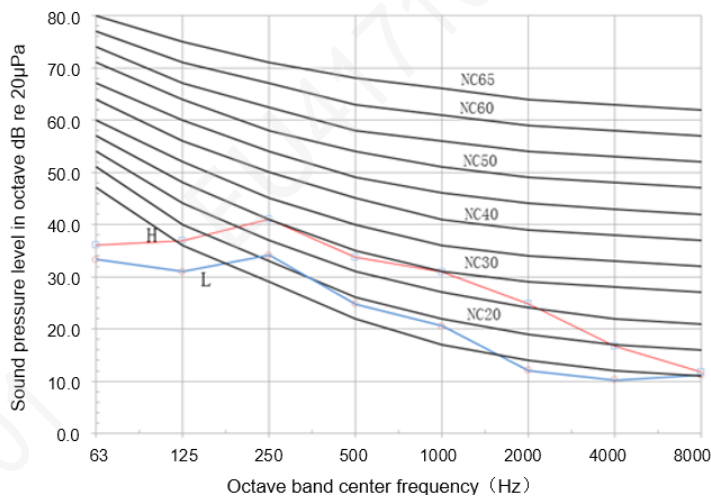

Model 56-63

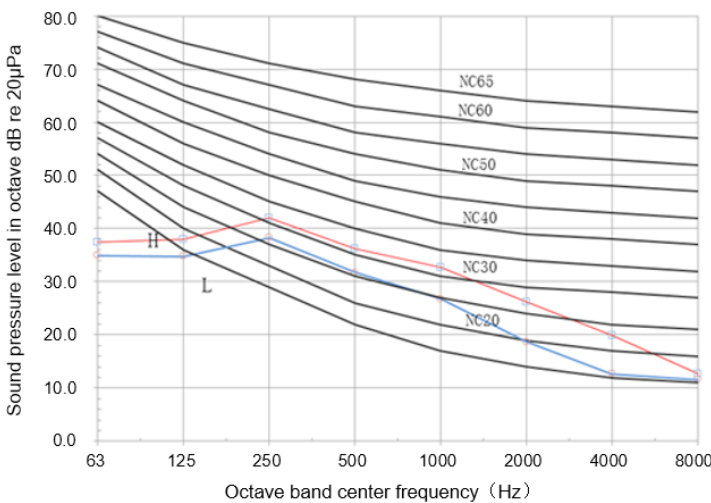

Model 71-80

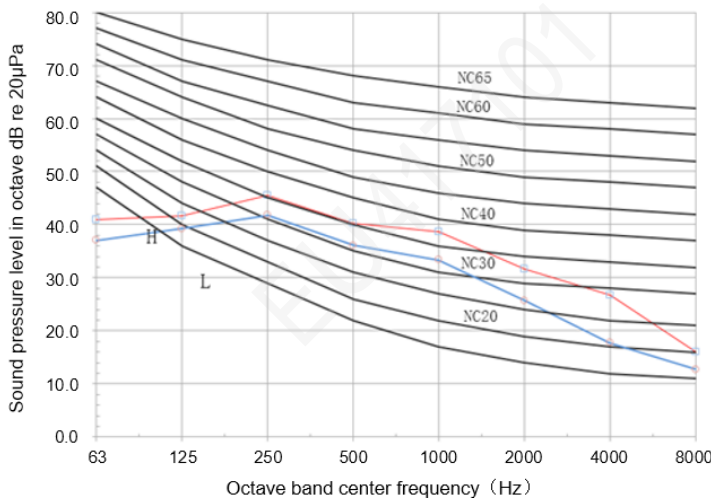

Model 90-112

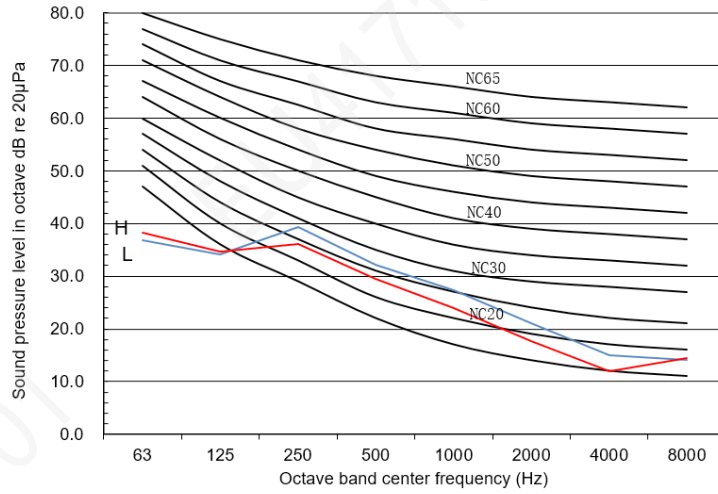

Model 125-140

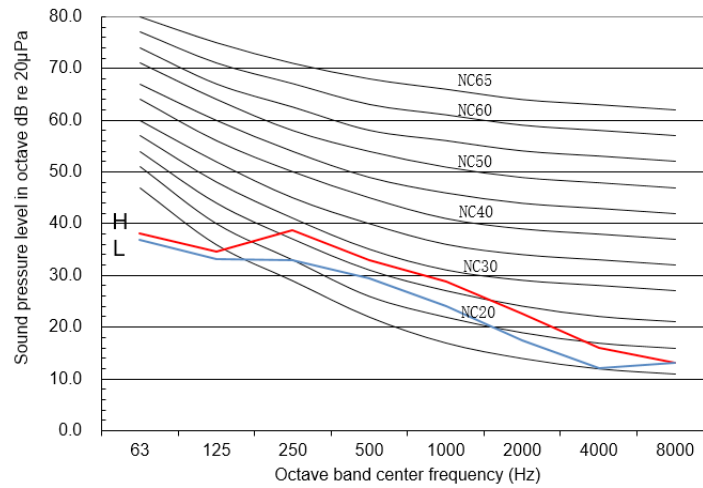

Model 160

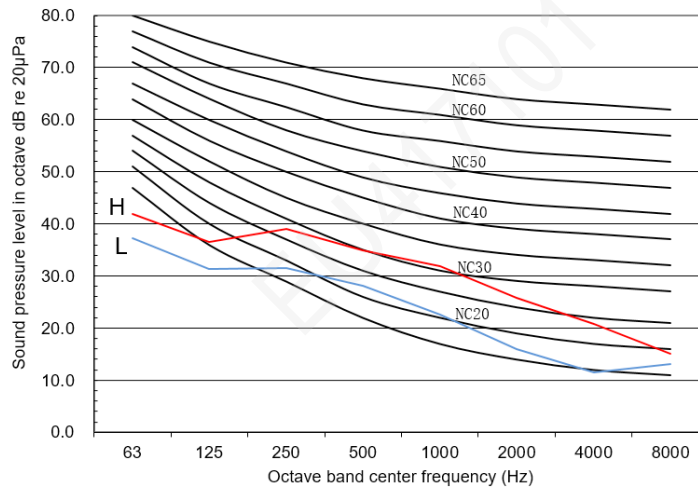

## 5.12 Fresh Air Processing Indoor Unit GMV-NDX\*\*P/A-T

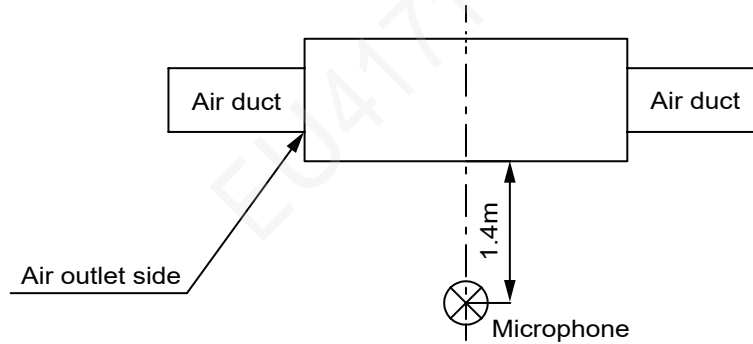

### Notes:

- ① The noise level is measured in the semi-anechoic room. It will be slightly higher due to change of the environment during actual operation.
- ② The noise level is measured under the standard test condition.
- ③ The noise level is measured under the condition of rear air return.

Model GMV-NDX125P/A-T, GMV-NDX140P/A-T

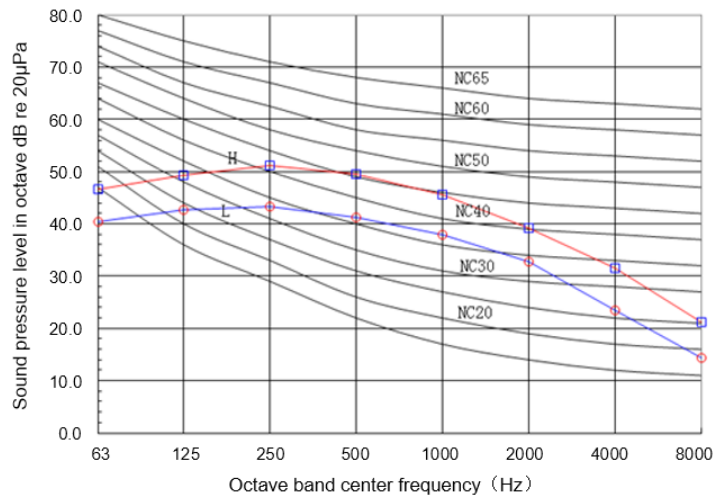

Model GMV-NDX224P/A-T

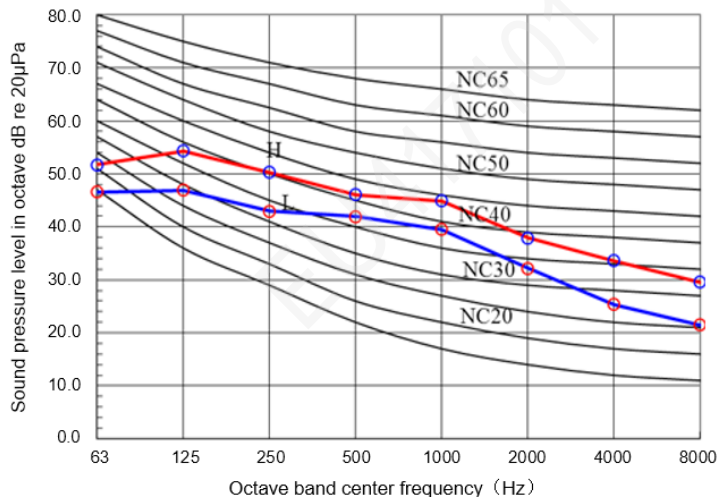



Model GMV-NDX250P/A-T, GMV-NDX280P/A-T

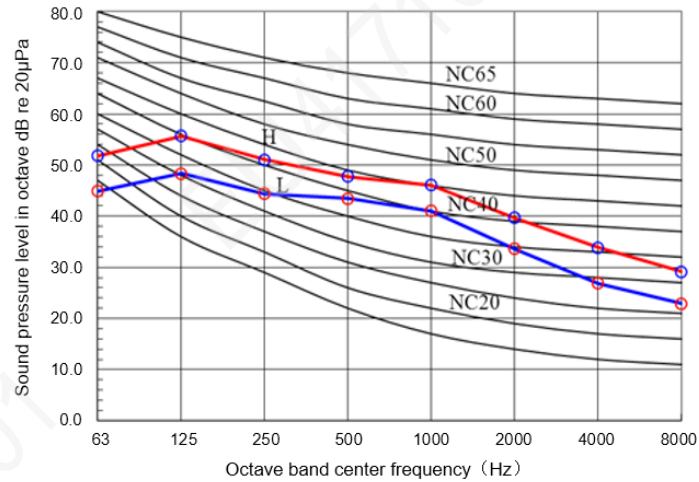

### 5.13 Air Handler type Indoor Unit

GMV-NR\*\*A/A-D

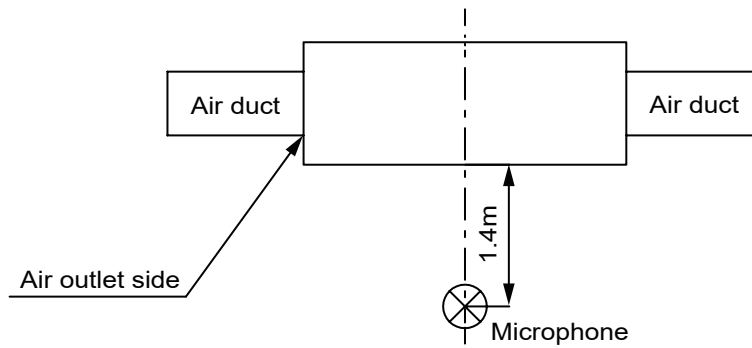

Notes:

- ① The noise level is measured in the semi-anechoic room. It will be slightly higher due to change of the environment during actual operation.
- ② The noise level is measured under the standard test condition.
- ③ The noise level is measured under the condition of rear air return. The noise level will be a little higher if the bottom air return mode is adopted.

Model 71-90

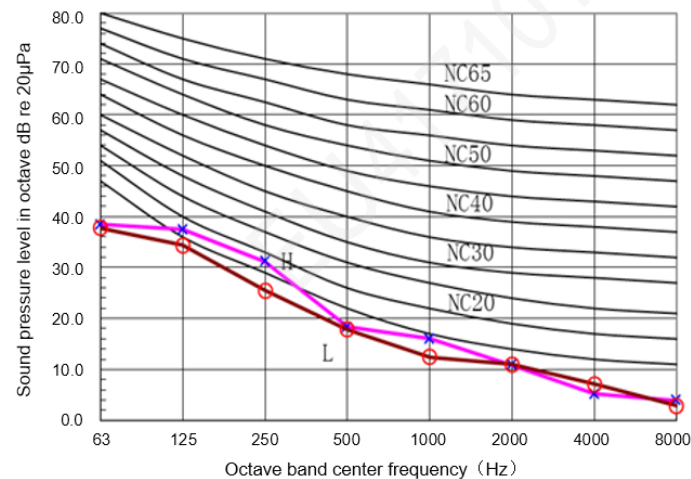



Model 100-112

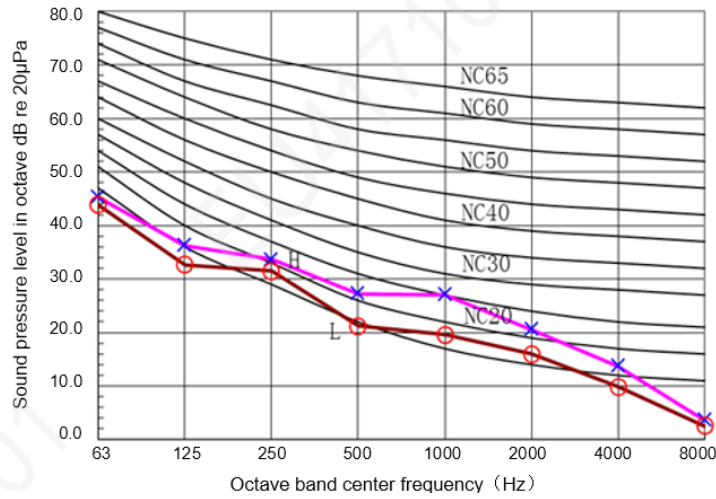

Model 140

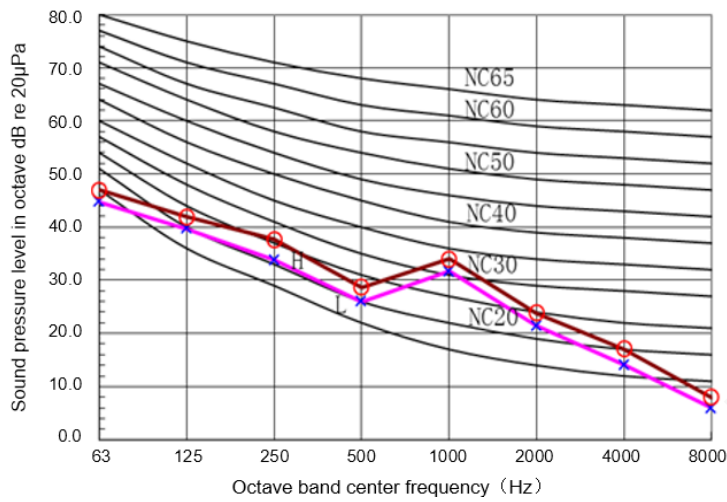

## 5.14 Super High Static Pressure Duct Type Indoor Unit GMV-ND\*\*PHS/B-T and GMV-ND\*\*PH/A-T

GMV-ND\*\*PHS/B-T

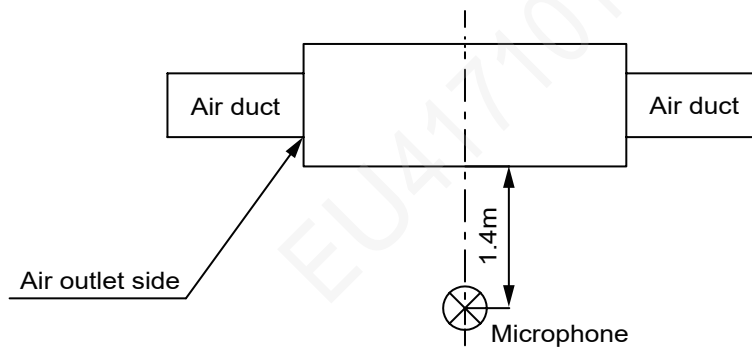

**Notes:**

- ① The noise level is measured in the semi-anechoic room. It will be slightly higher due to change of the environment during actual operation.
- ② The noise level is measured under the standard test condition.

③ The noise level is measured under the condition of rear air return. The noise level will be a little higher if the bottom air return mode is adopted.  
Model 22-36

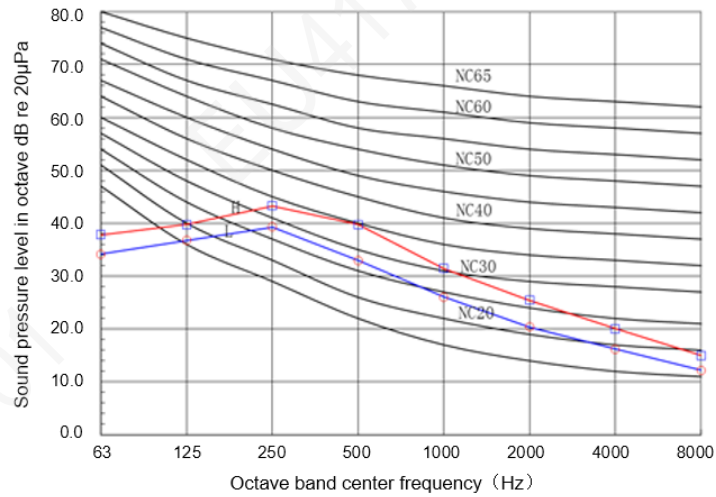

Model 40-80

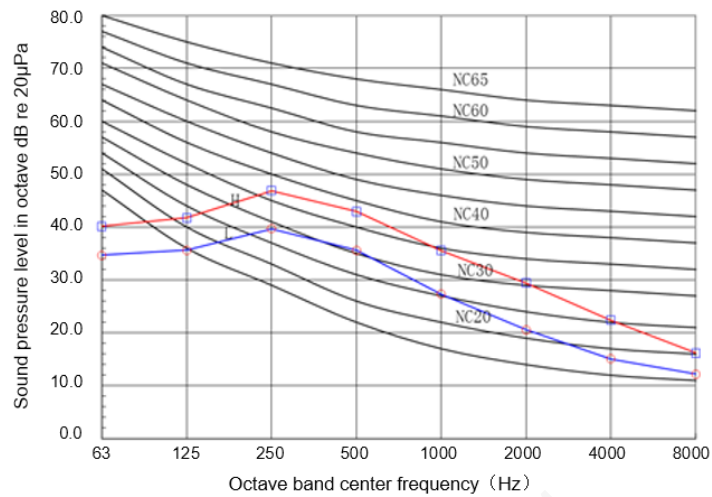

Model 90-125

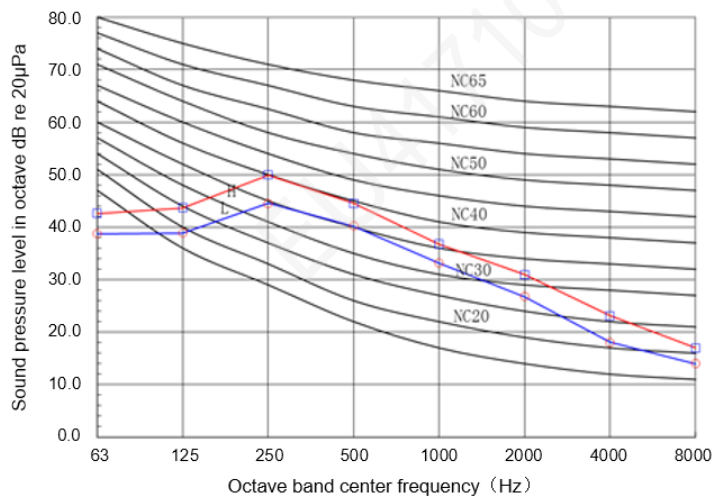

## Model 140-160

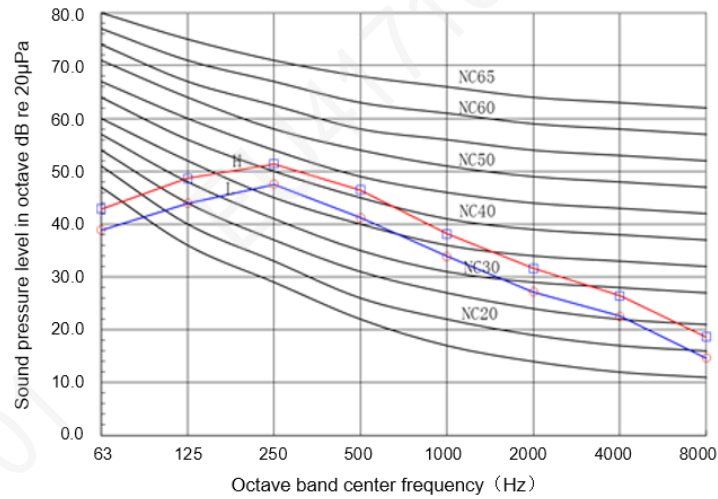

## Model 180

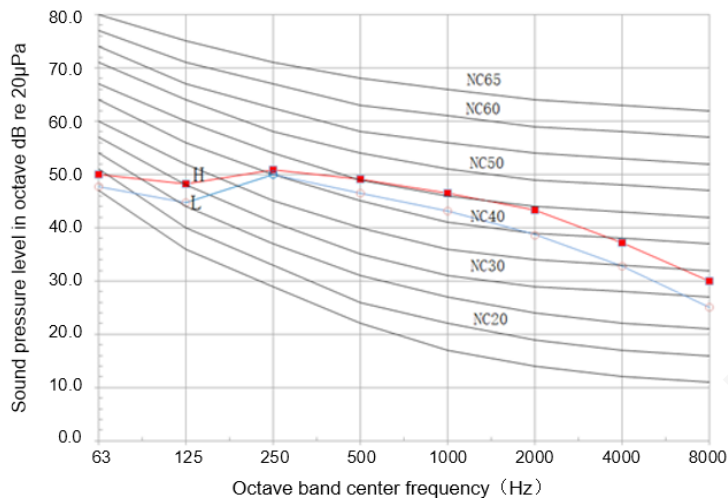

## GMV-ND\*\*PH/A-T Model 224

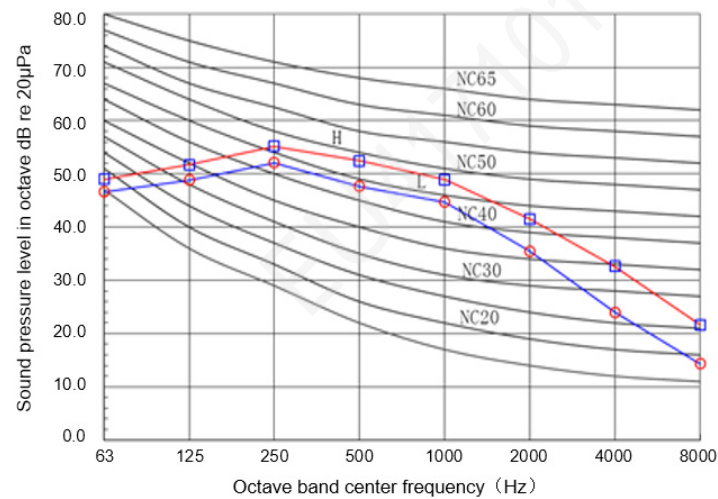

Model 280

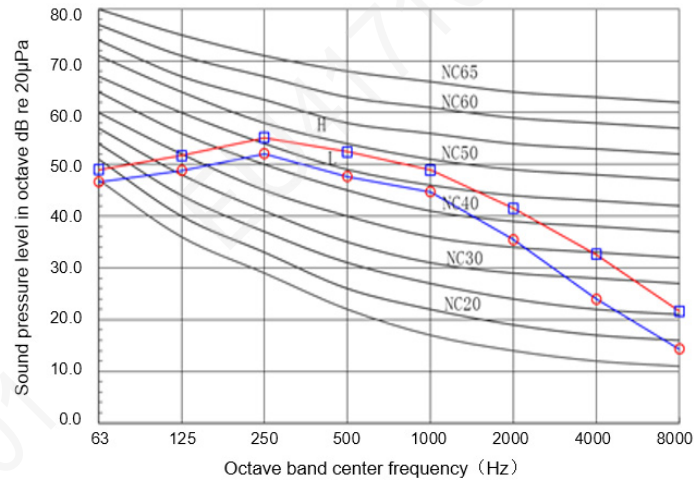

**5.15 Concealed Floor Standing Type GMV-ND\*\*ZA/A-T**

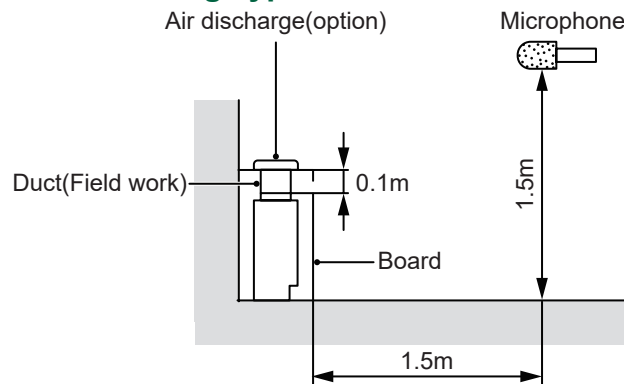

Notes:

- ① The noise level is measured in the semi-anechoic room. It will be slightly higher due to change of the environment during actual operation.
- ② The noise level is measured under the standard test condition.
- ③ The noise level is measured under the condition of rear air return. The noise level will be a little higher if the bottom air return mode is adopted.

Model 22-28

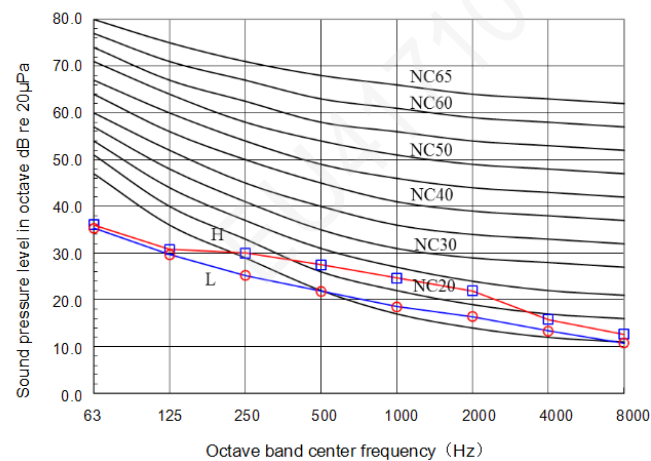

## Model 36

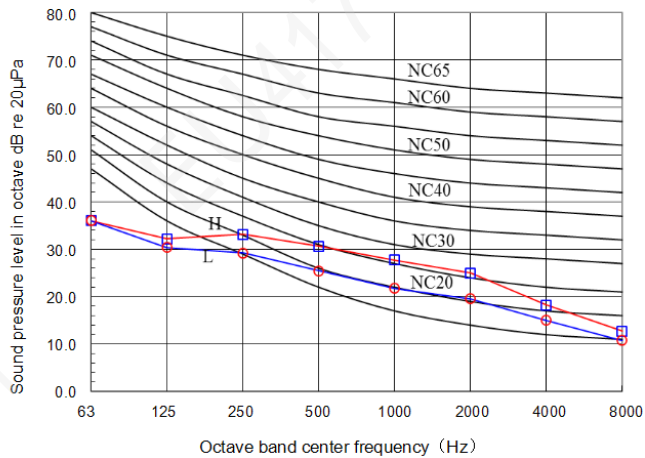

## Model 45

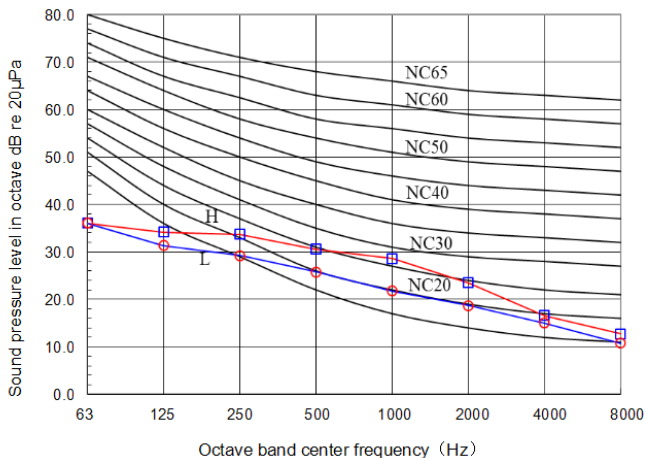

## Model 56-63

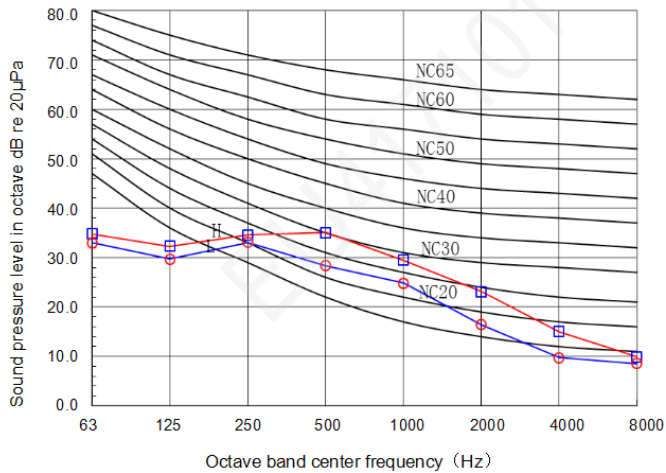

Model 71

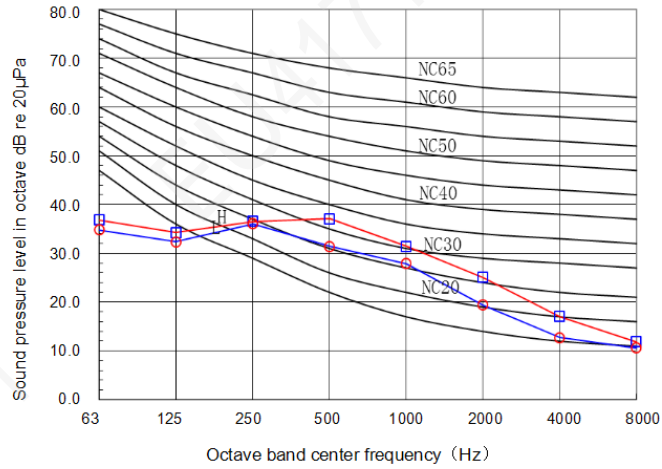

**5.16 360° Air Discharge Cassette Type GMV-ND\*\*T/C-T**

**5.16.1 GMV-ND\*\*T/C-T**

Model 22-45

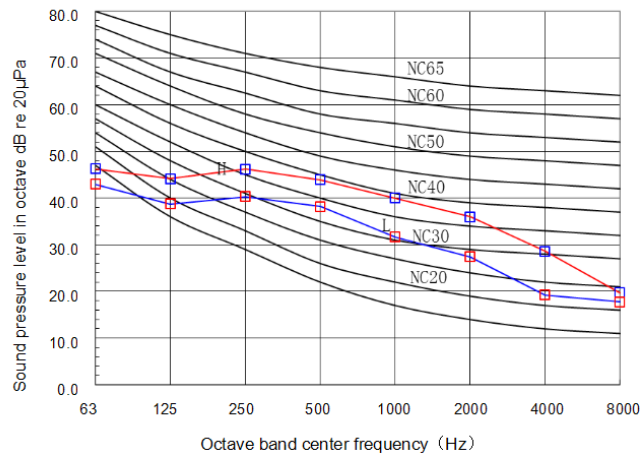

Model 50-71

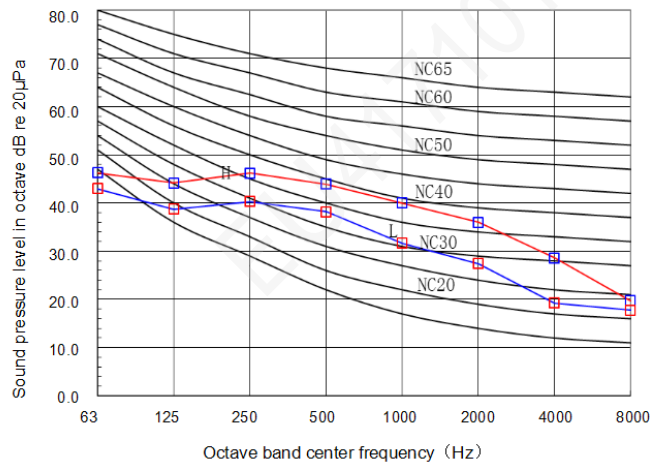



## Model 80-100

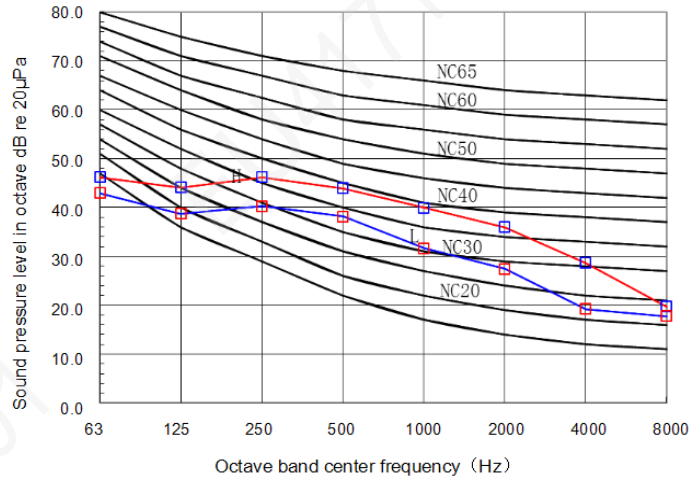

## Model 112-140

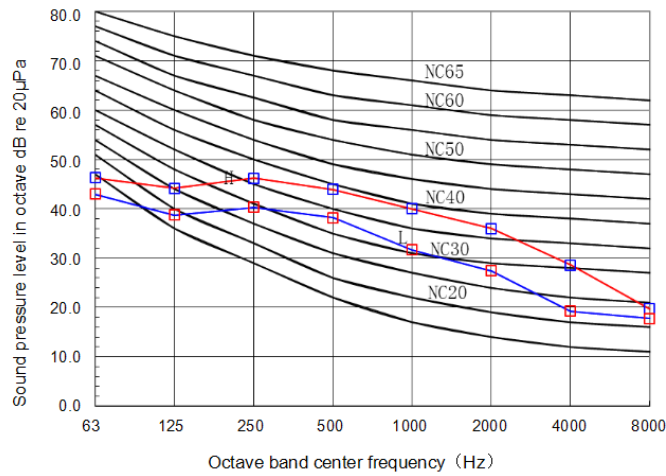

## Model 160

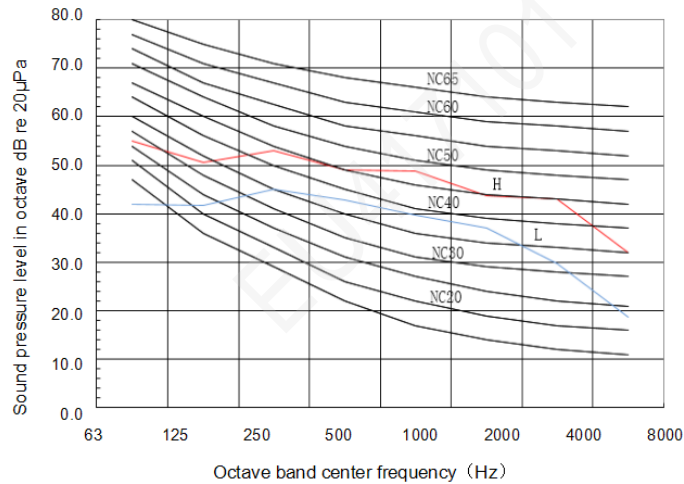



### 5.16.2 GMV-ND\*\*T/C1-T

Model 22

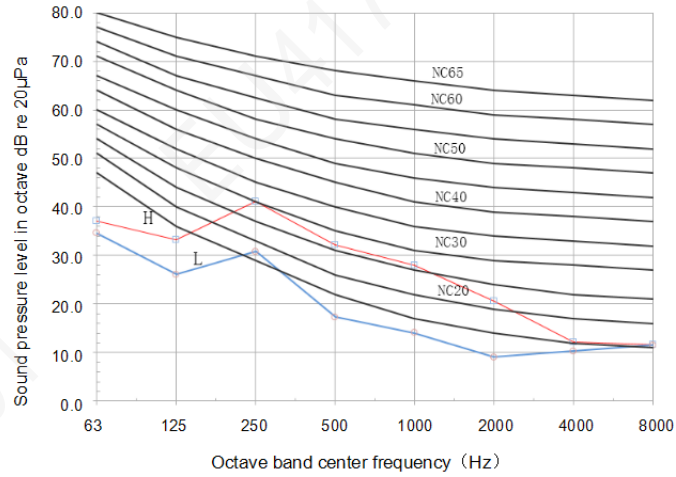

Model 28/36/45

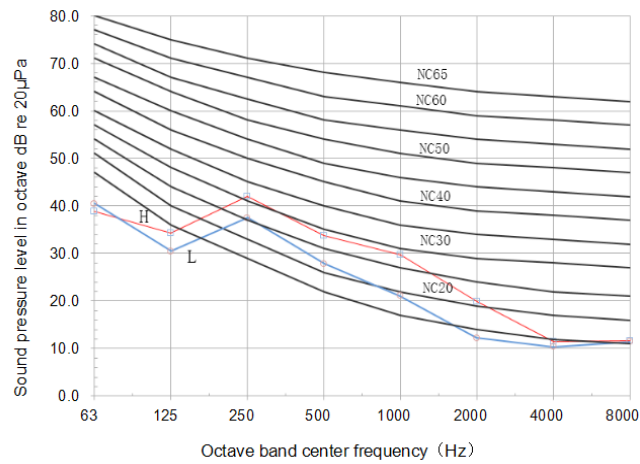

Model 50

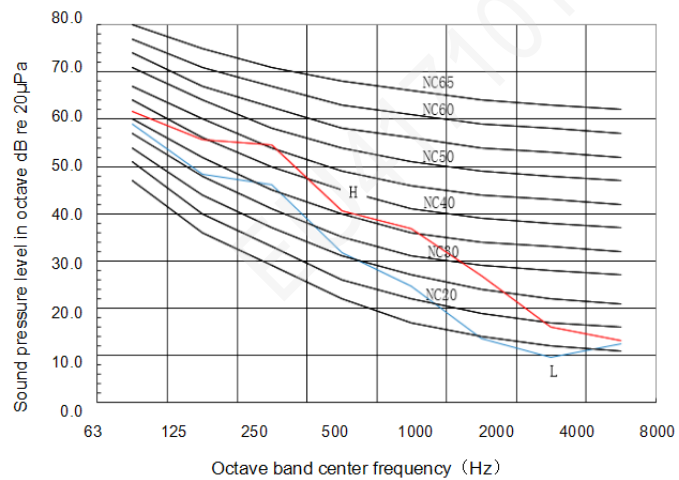

## 5.16.3 GMV-ND\*\*T/D1-T

Model 22/28/36

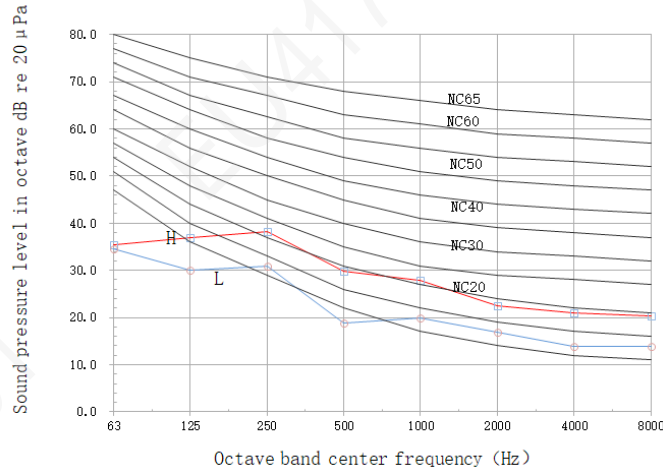

Model 45/50

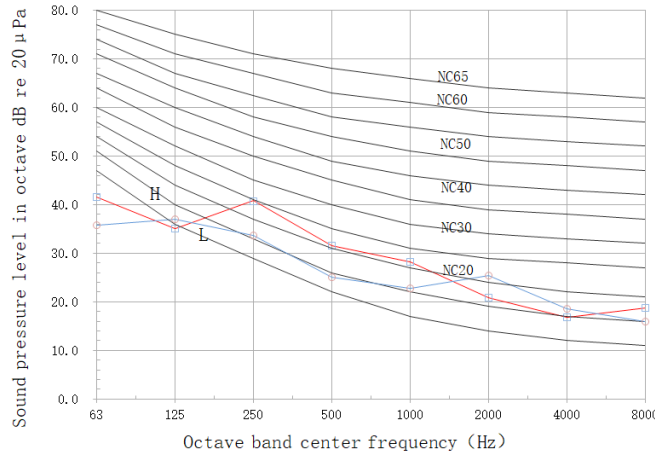

Model 56/63/71

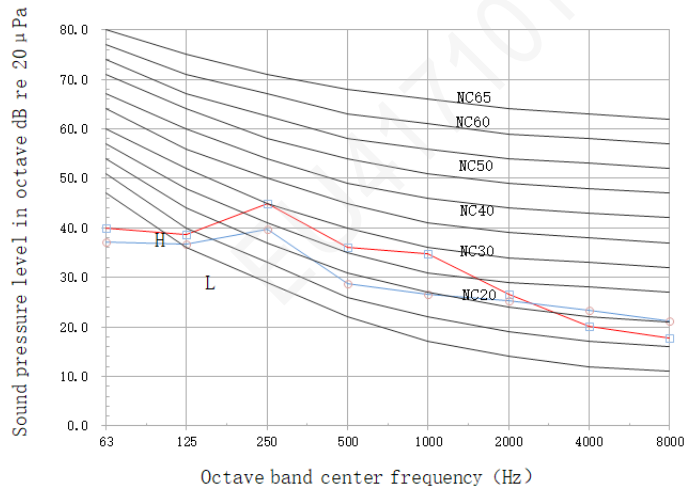

Model 80/90

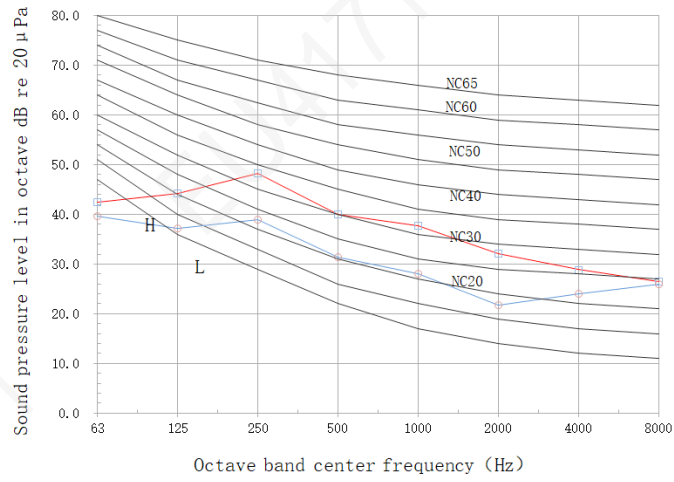

Model 100/112

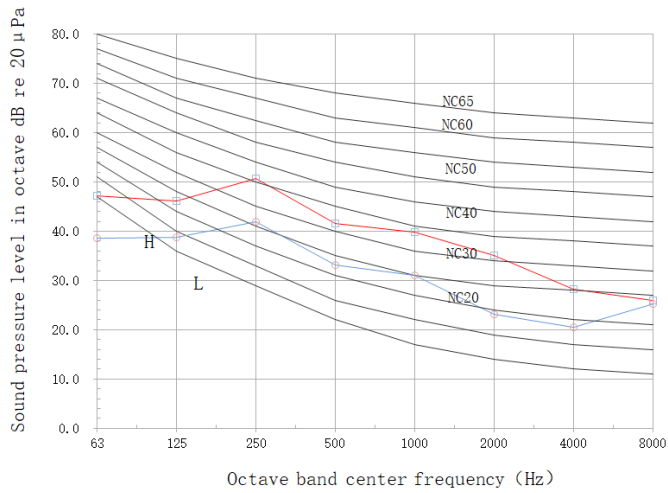

Model 125/140

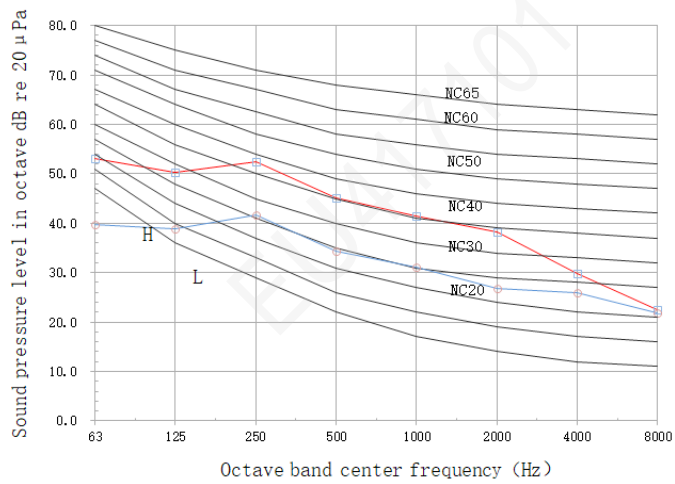

## 5.17 High Static Pressure Duct Type Indoor Unit GMV-ND\*\*PHS/D-T

GMV-ND\*\*PHS/D-T

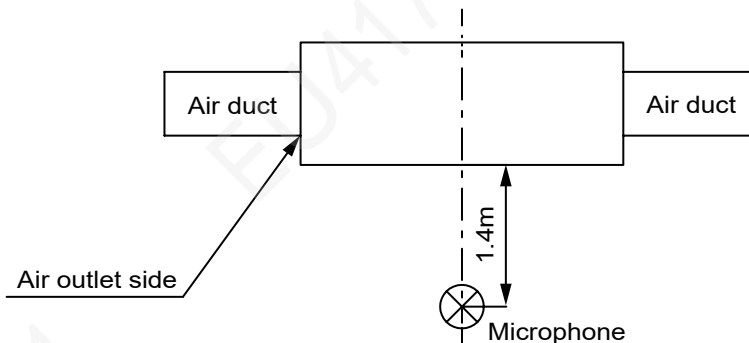

Notes:

- ① The noise level is measured in the semi-anechoic room. It will be slightly higher due to change of the environment during actual operation.
- ② The noise level is measured under the standard test condition.
- ③ The noise level is measured under the condition of rear air return. The noise level will be a little higher if the bottom air return mode is adopted.

Model 22-36

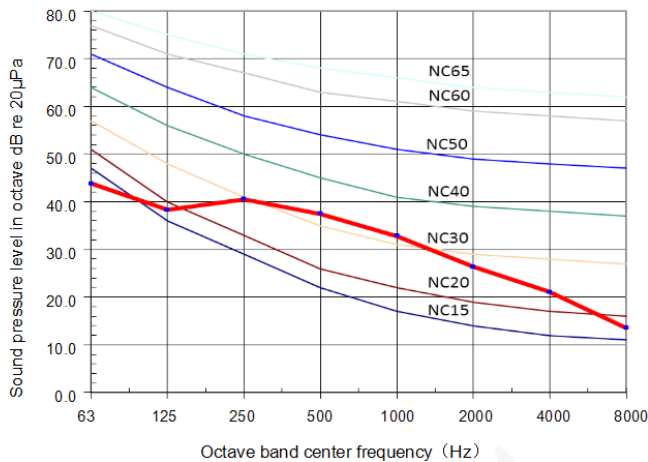

Model 40-50

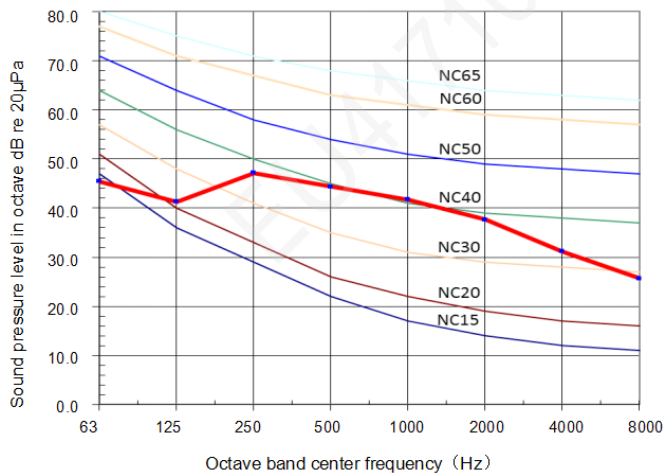

Model 56-63

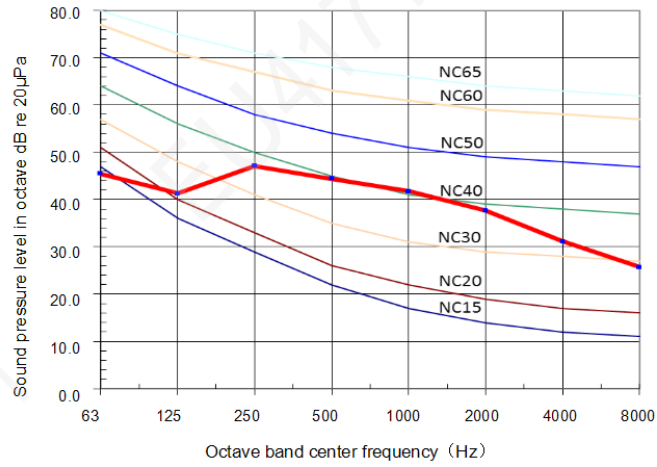

Model 71-80

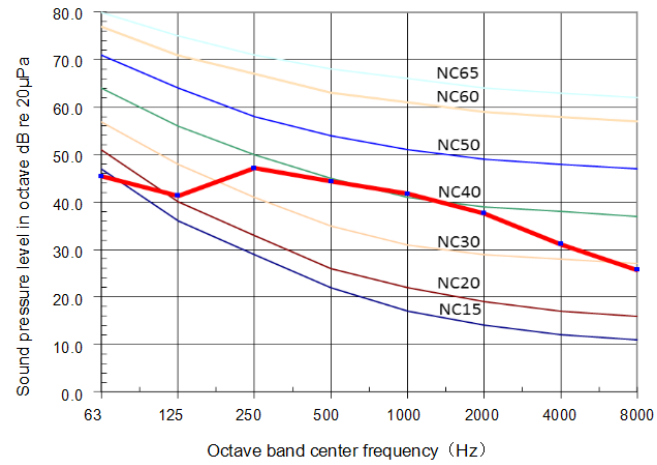

Model 90-125

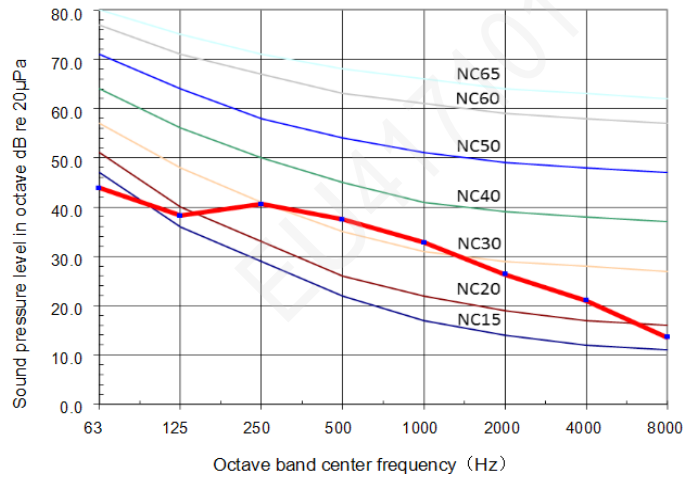

Model 140-160

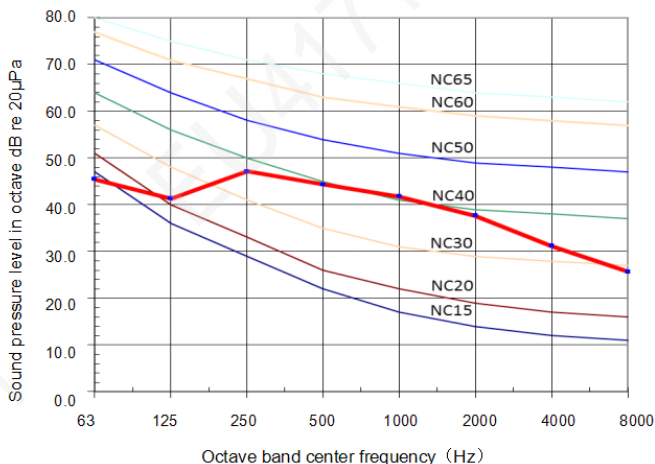

Model 180

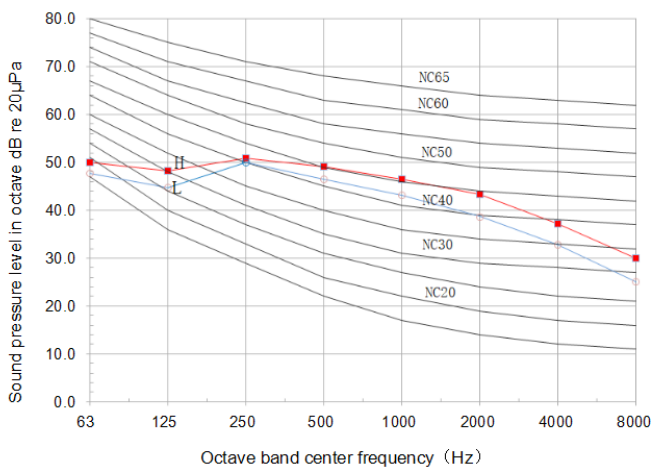

## 5.18 Middle Static Pressure Duct Type Indoor Unit GMV-ND\*\*PMS/A1-T

GMV-ND\*\*PMS/A1-T

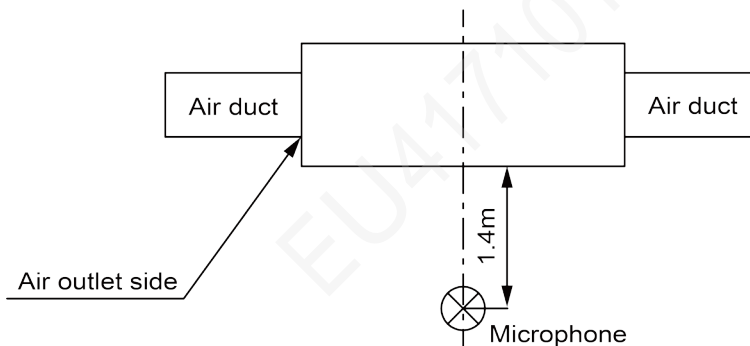

Notes:

- ① The noise level is measured in the semi-anechoic room. It will be slightly higher due to change of the environment during actual operation.
- ② The noise level is measured under the standard test condition.

③ The noise level is measured under the condition of rear air return. The noise level will be a little higher if the bottom air return mode is adopted.  
Model 56~71

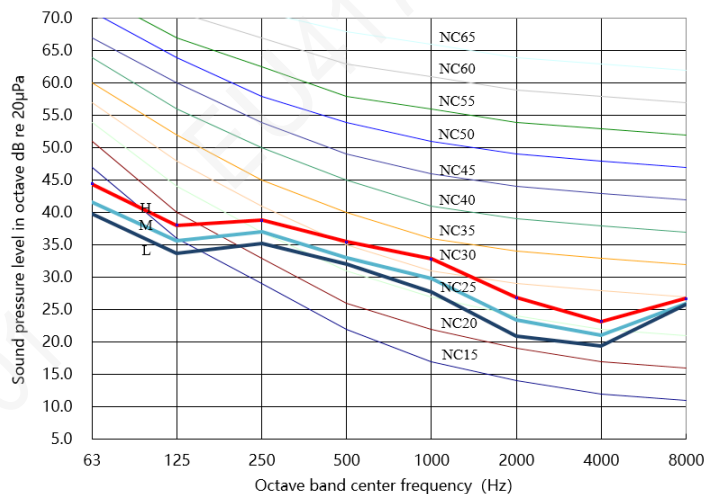

Model 80

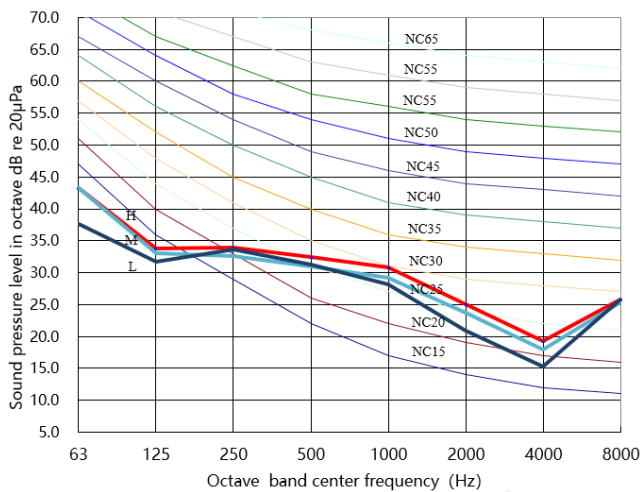

Model 90-112

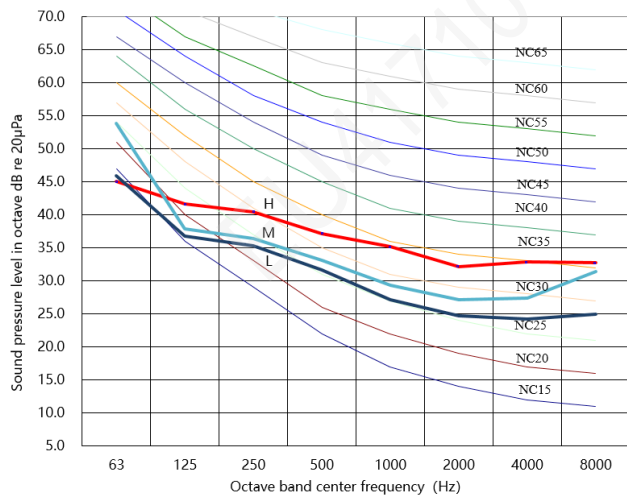



Model 125-140

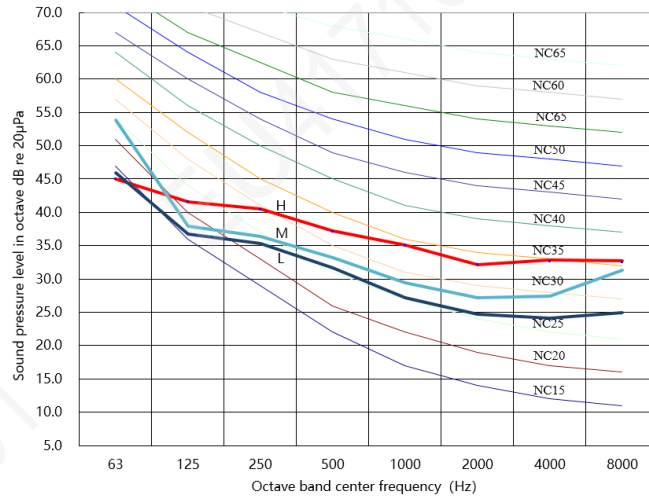

## 6 FAN CHARACTERISTICS

### 6.1 General static pressure Duct Type

GMV-ND18PLS/C-T, GMV-ND22PLS/C-T, GMV-ND25PLS/C-T, GMV-ND28PLS/C-T,  
GMV-ND18PLS/C1-T, GMV-ND22PLS/C1-T, GMV-ND25PLS/C1-T, GMV-ND28PLS/C1-T

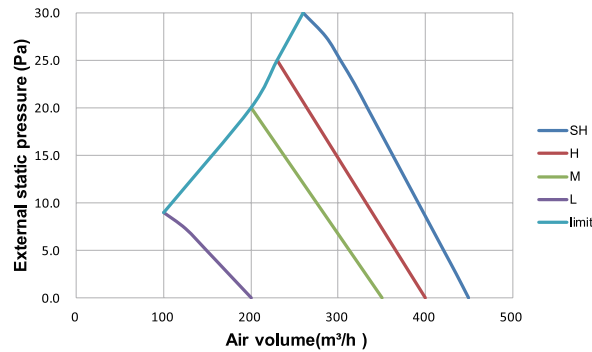

GMV-ND32PLS/C-T, GMV-ND36PLS/C-T, GMV-ND32PLS/C1-T, GMV-ND36PLS/C1-T

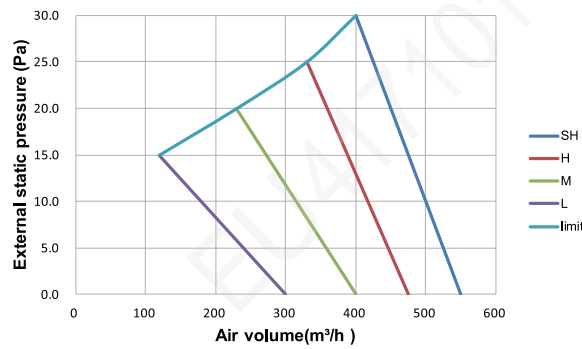

GMV-ND40PLS/C-T, GMV-ND45PLS/C-T, GMV-ND40PLS/C1-T, GMV-ND45PLS/C1-T, GMV-ND50PLS/C1-T

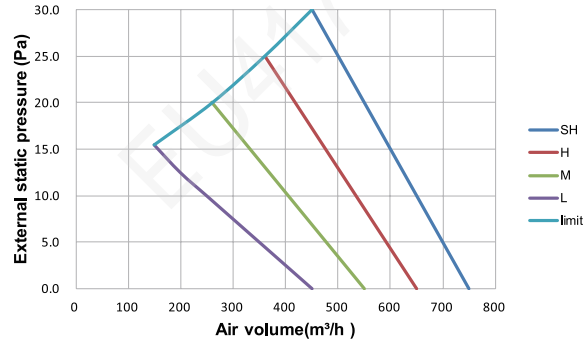

GMV-ND50PLS/C-T, GMV-ND56PLS/C-T, GMV-ND63PLS/C-T, GMV-ND56PLS/C1-T, GMV-ND63PLS/C1-T

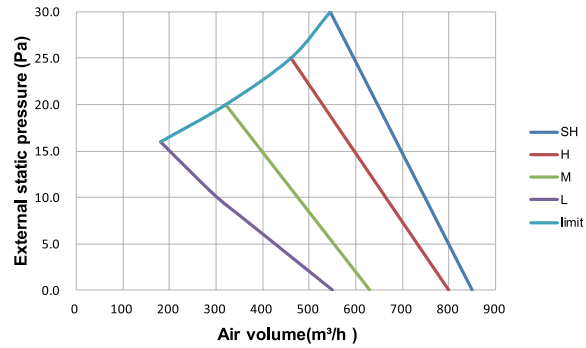

GMV-ND71PLS/C-T, GMV-ND71PLS/C1-T

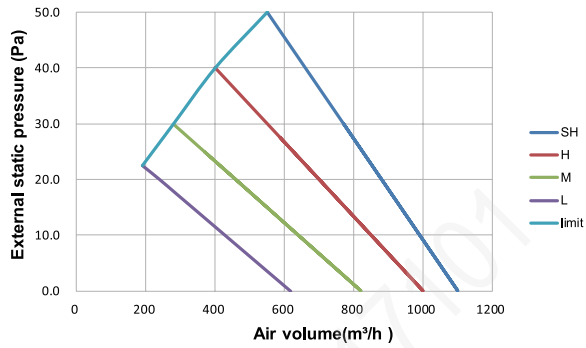

# DC INVERTER MULTI VRF INDOOR UNIT TECHNICAL SALES GUIDE

## GMV-ND80PLS/C1-T

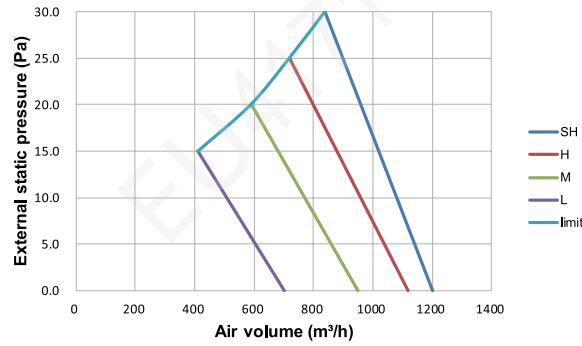

## GMV-ND80PLS/C-T

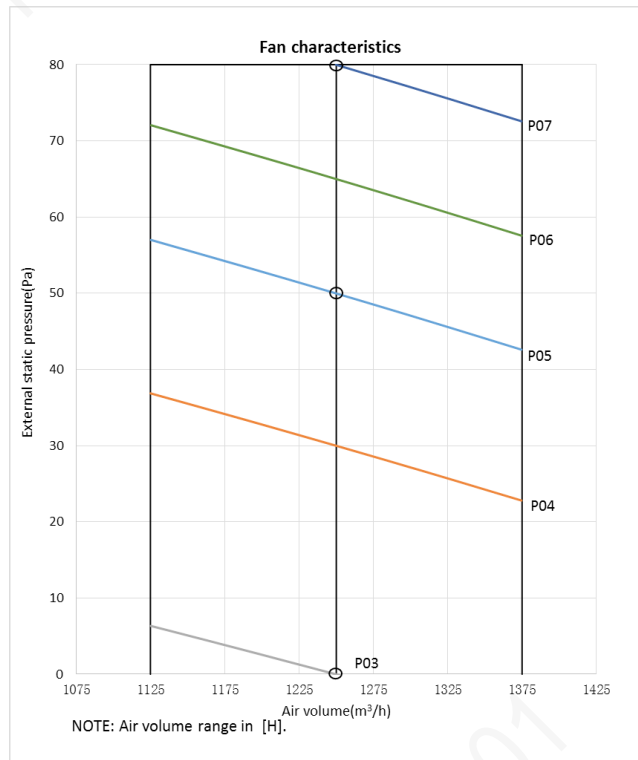

GMV-ND90PLS/C-T, GMV-ND100PLS/C-T

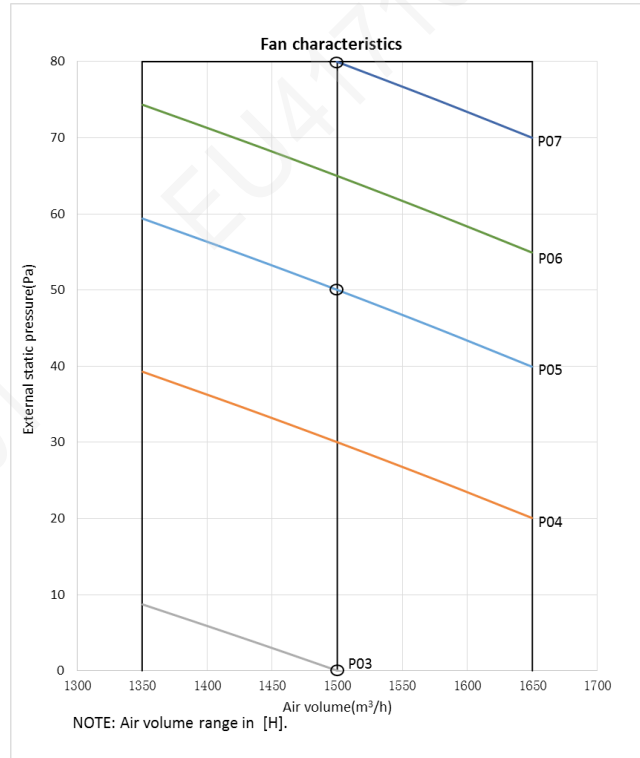

GMV-ND112PLS/C-T

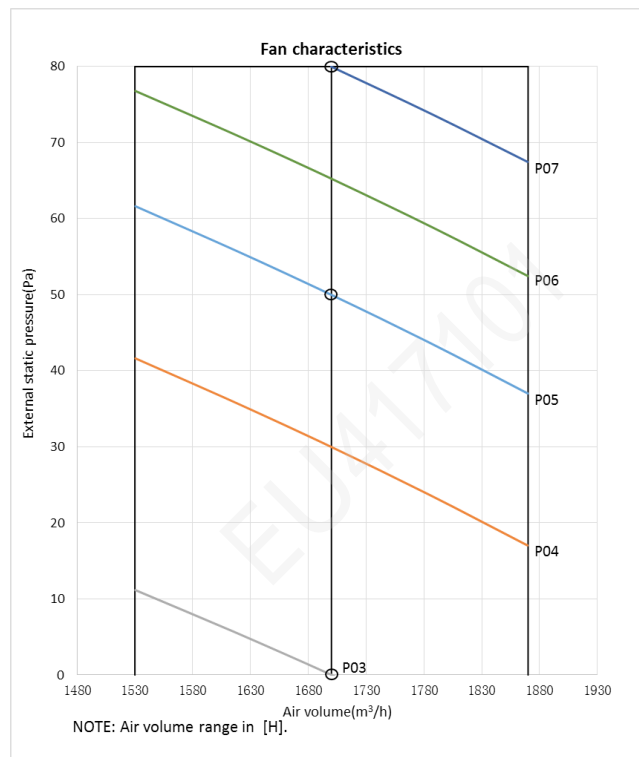

GMV-ND125PLS/C-T, GMV-ND140PLS/C-T

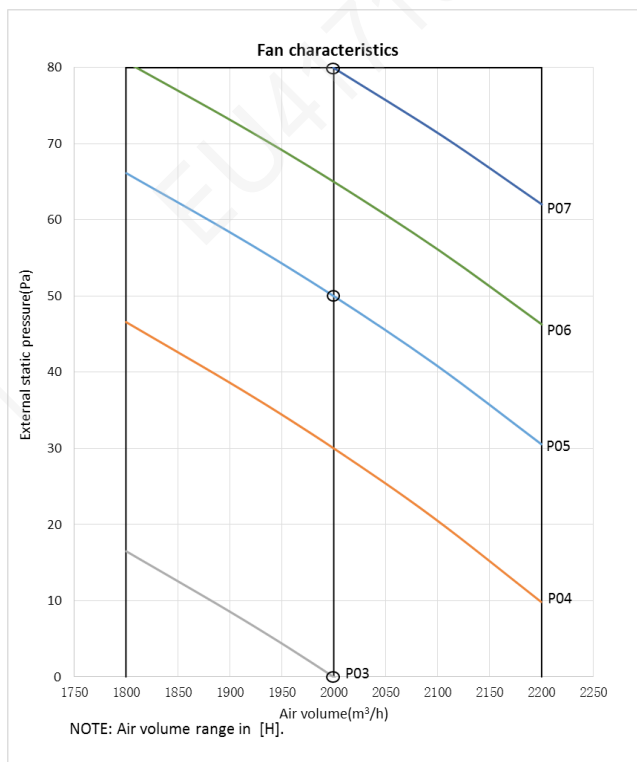

## 6.2 Slim Duct Type

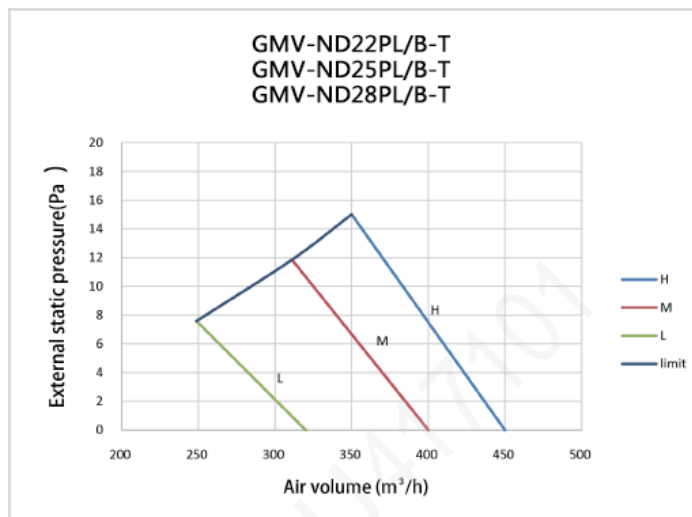

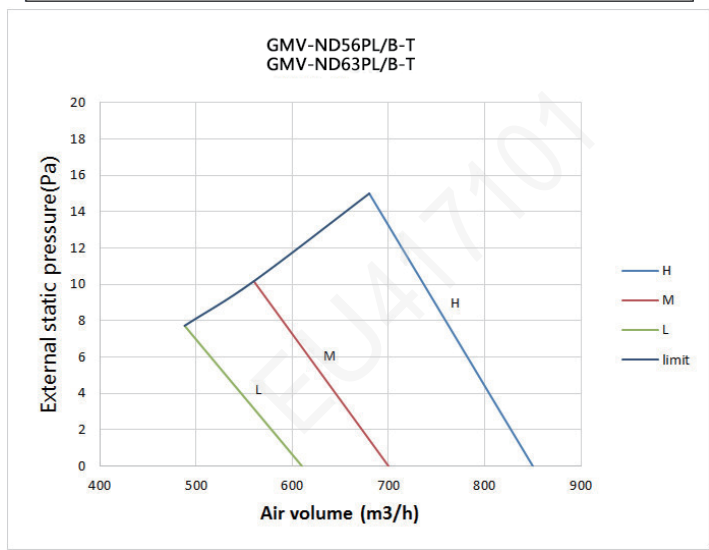
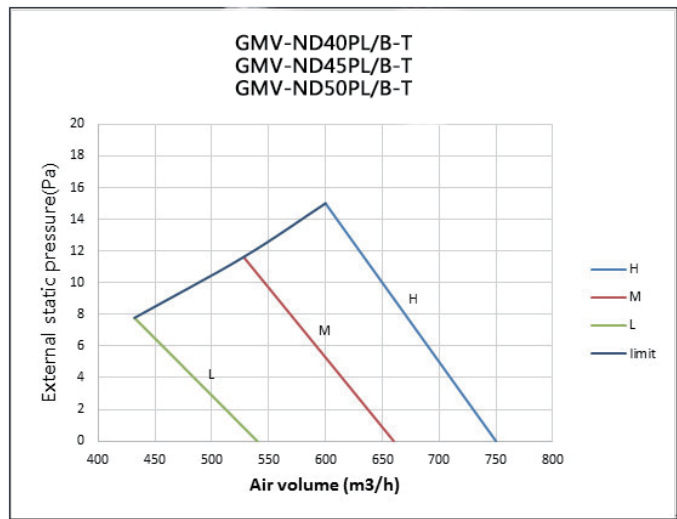
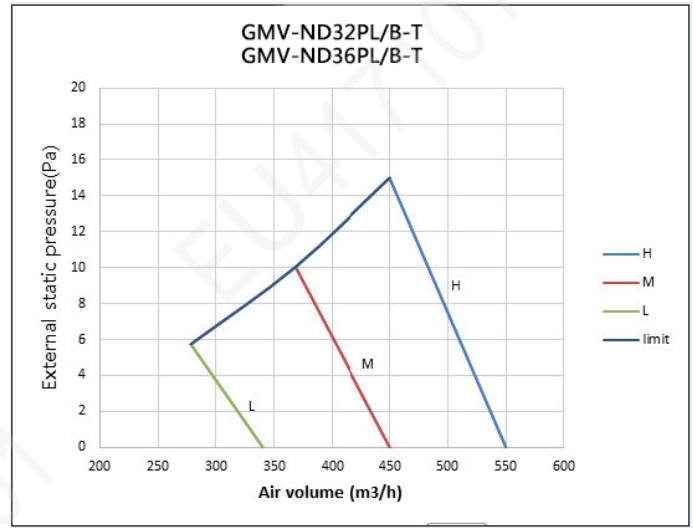

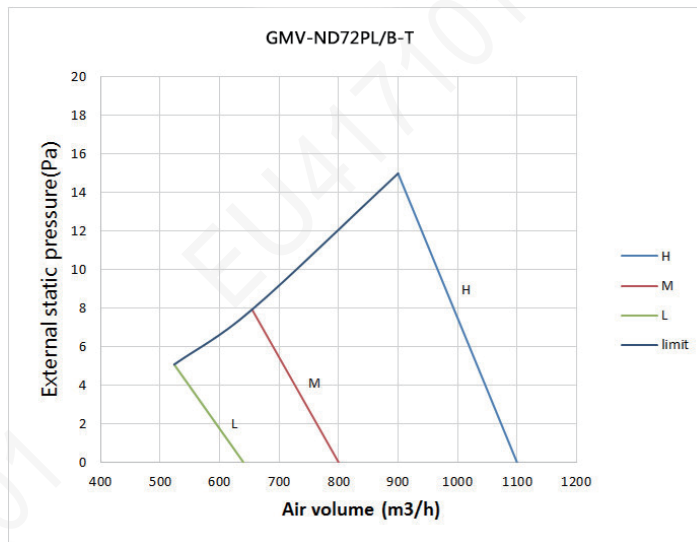

### 6.3 Fresh Air Processing Indoor Unit

When this unit is installed, select the static pressure according to the actual air volume from 1000~3500m<sup>3</sup>/h . There're 13 static pressure step for selection. Please refer to the Installation, Debugging and Maintenance Manual for the adjustment method for the static pressure. The curve diagram between air volume and static pressure is as below. The corresponding static pressure is from step 1 to step13 for the curve from lower to upper side.

GMV-NDX125P/A-T / GMV-NDX140P/A-T

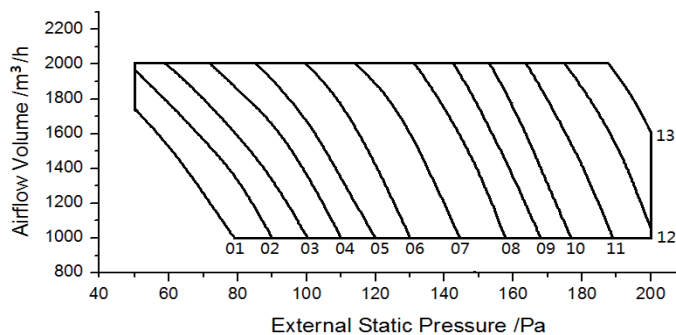

GMV-NDX224P/A-T

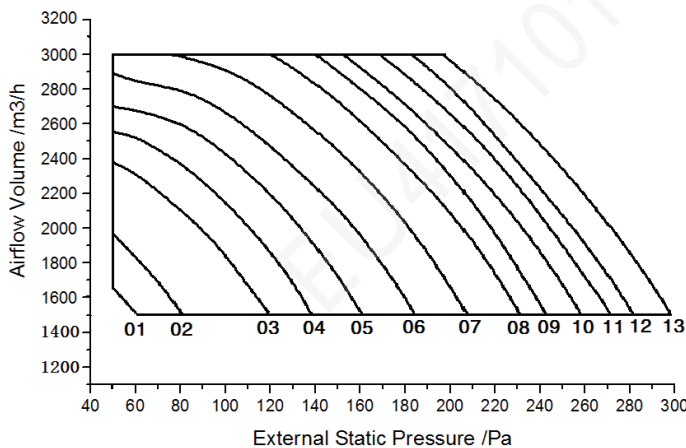



GMV-NDX250P/A-T / GMV-NDX280P/A-T

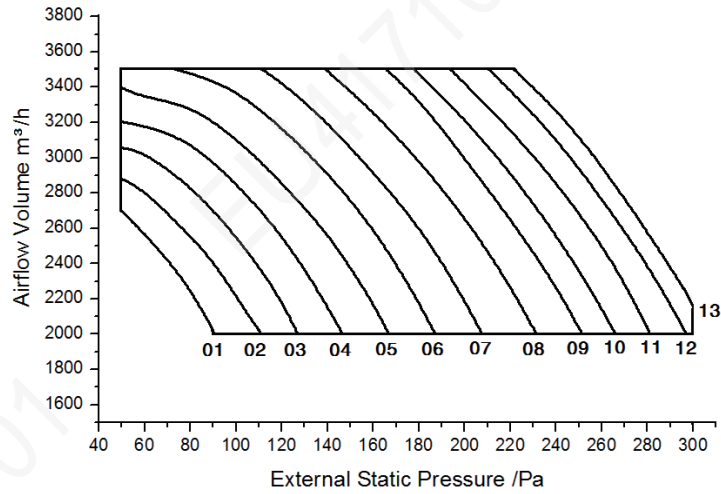

### 6.4 Concealed Floor Standing Type

GMV-ND22ZA/A-T  
GMV-ND28ZA/A-T

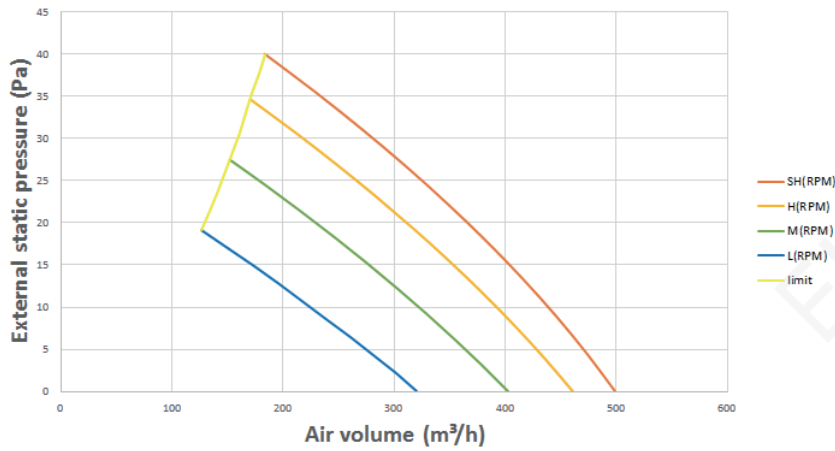

GMV-ND36ZA/A-T

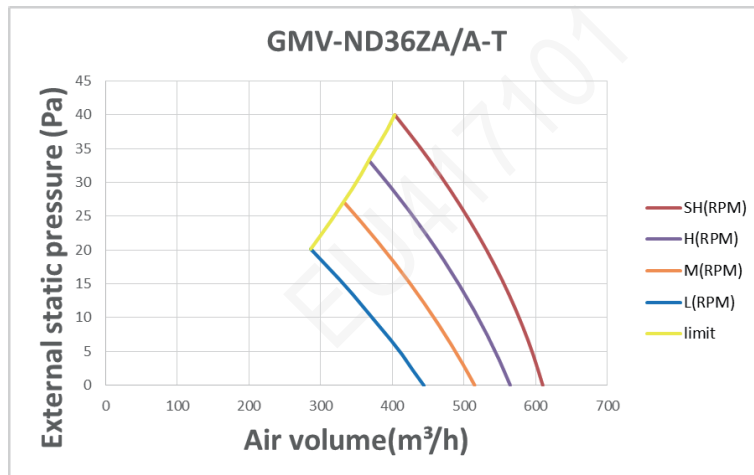

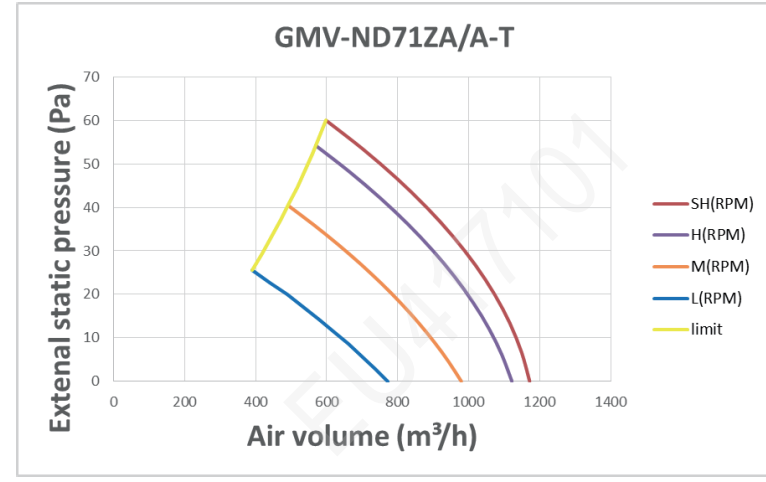
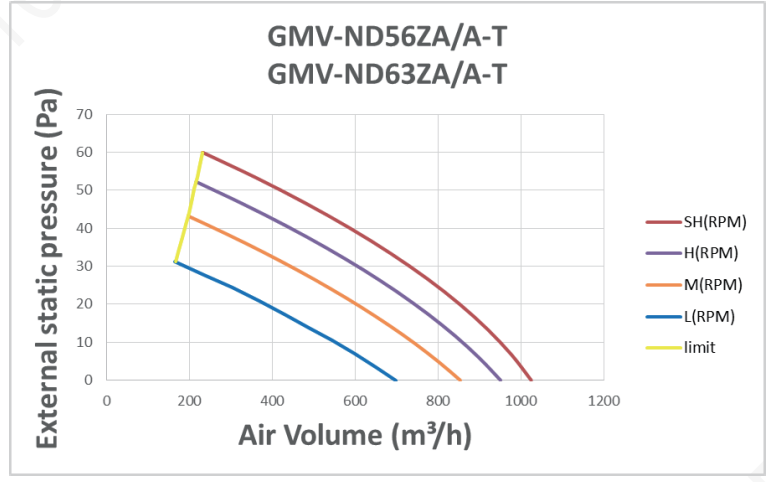
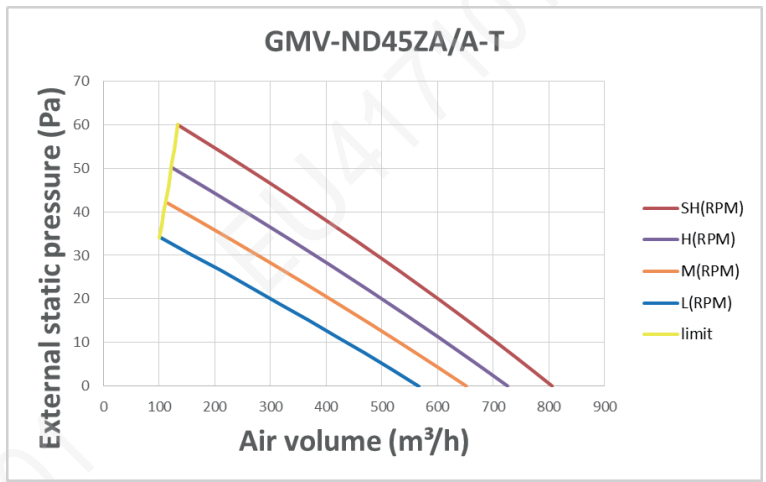

### 6.5 Super High Static Pressure Duct Type Indoor Unit

GMV-ND22PHS/B-T, GMV-ND25PHS/B-T, GMV-ND28PHS/B-T

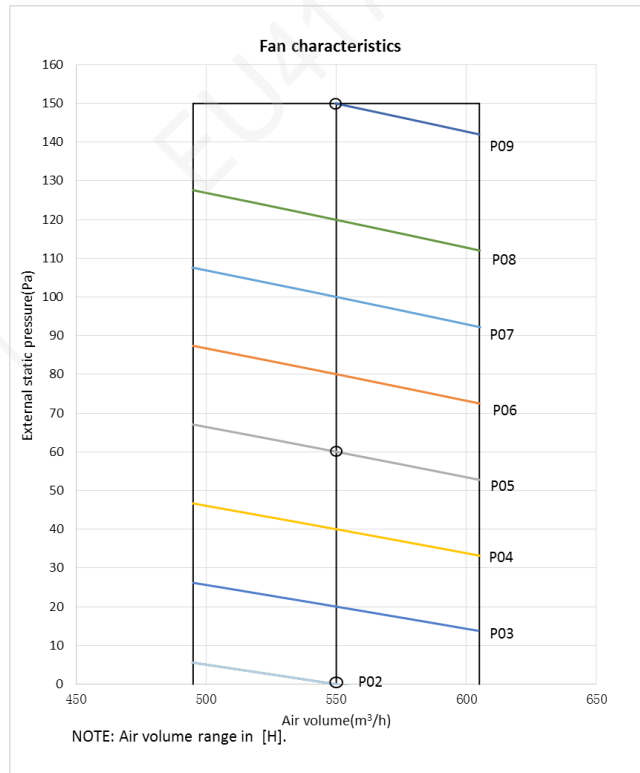

GMV-ND32PHS/B-T, GMV-ND36PHS/B-T

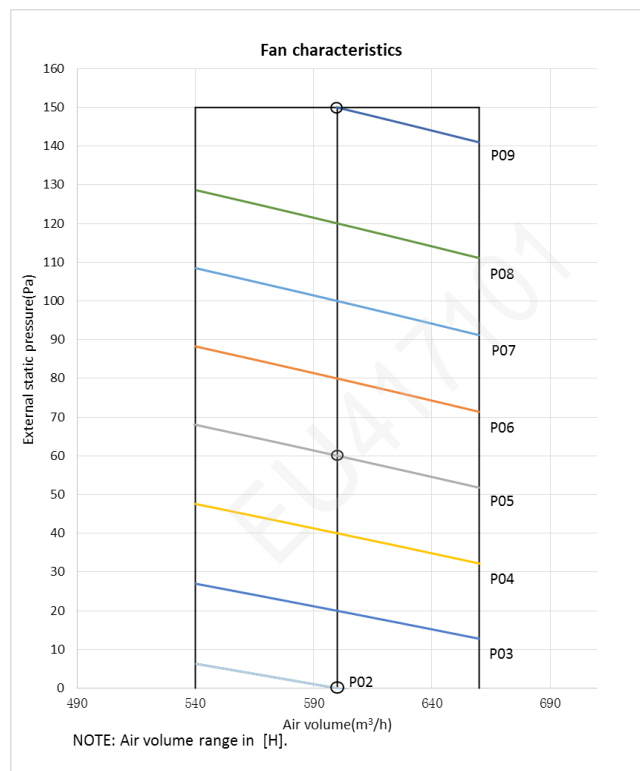

## GMV-ND40PHS/B-T, GMV-ND45PHS/B-T, GMV-ND50PHS/B-T

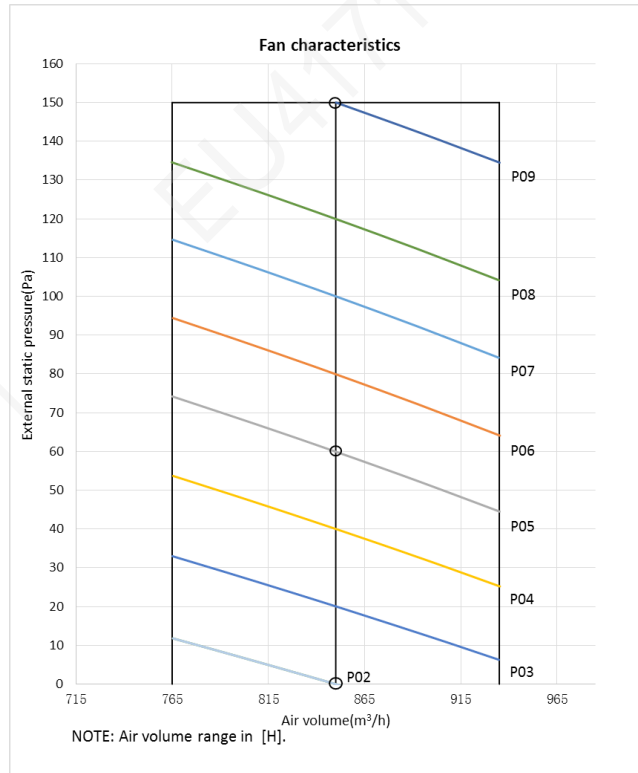

## GMV-ND56PHS/B-T, GMV-ND63PHS/B-T

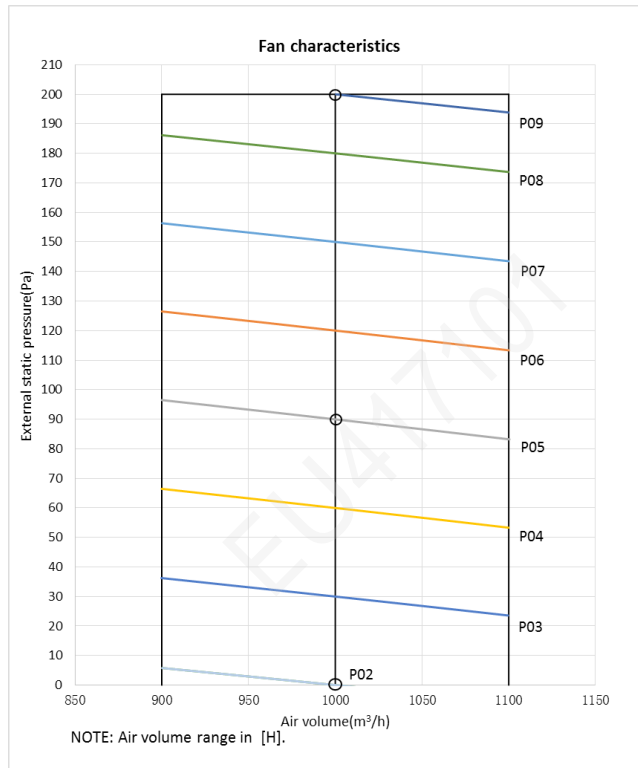

GMV-ND71PHS/B-T, GMV-ND80PHS/B-T

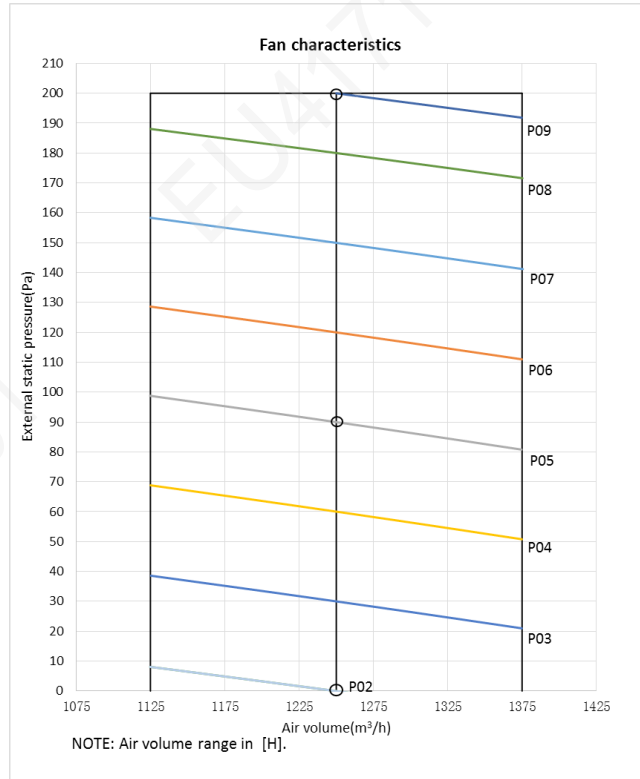

GMV-ND90PHS/B-T, GMV-ND100PHS/B-T

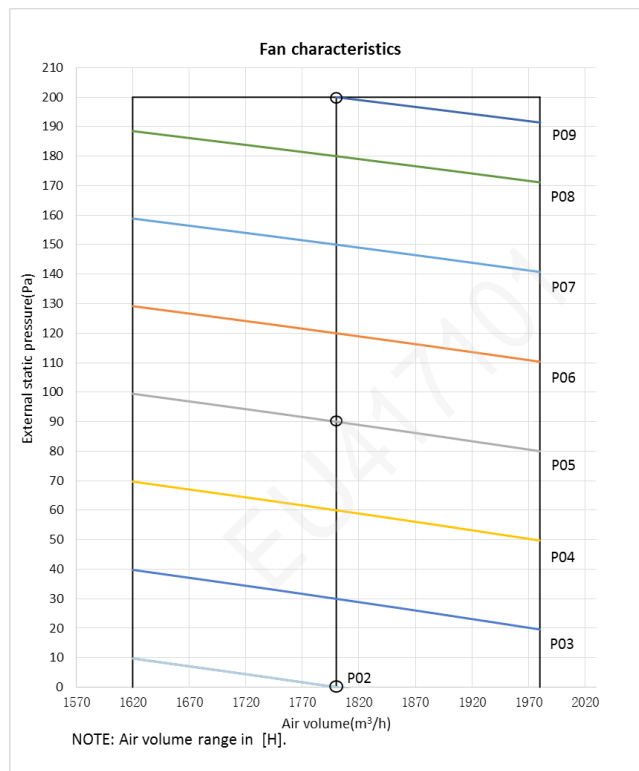

## GMV-ND112PHS/B-T, GMV-ND125PHS/B-T

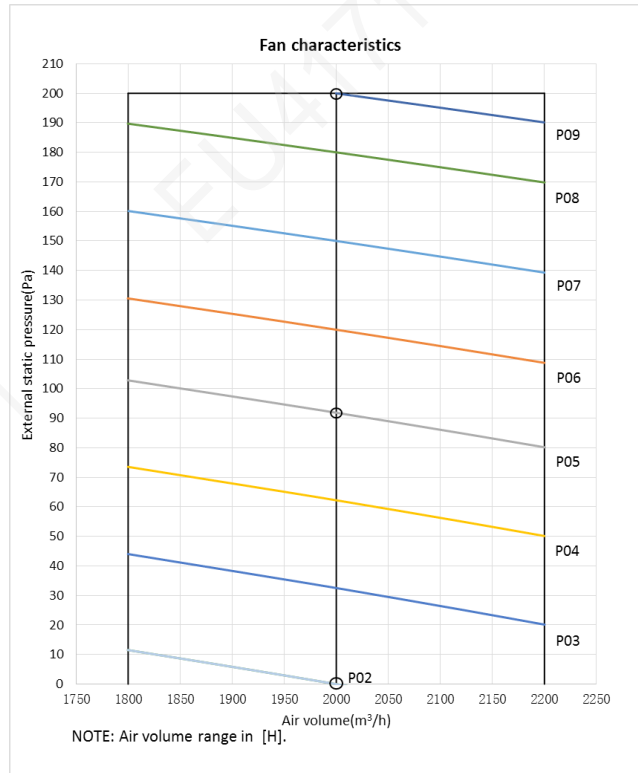

## GMV-ND140PHS/B-T

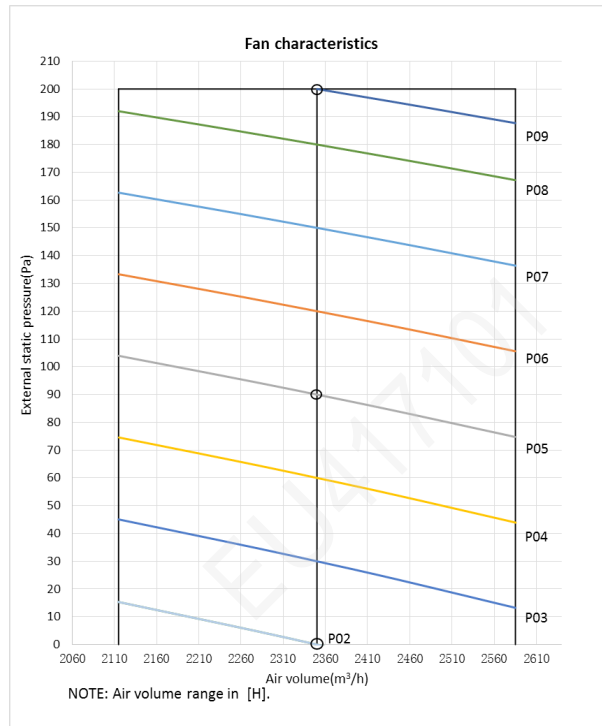

GMV-ND160PHS/B-T

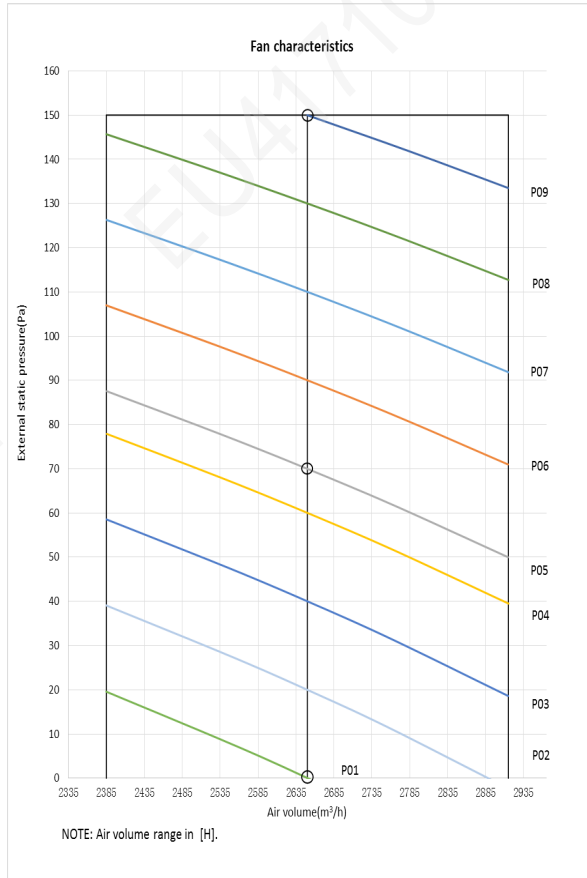

GMV-ND180PHS/B-T

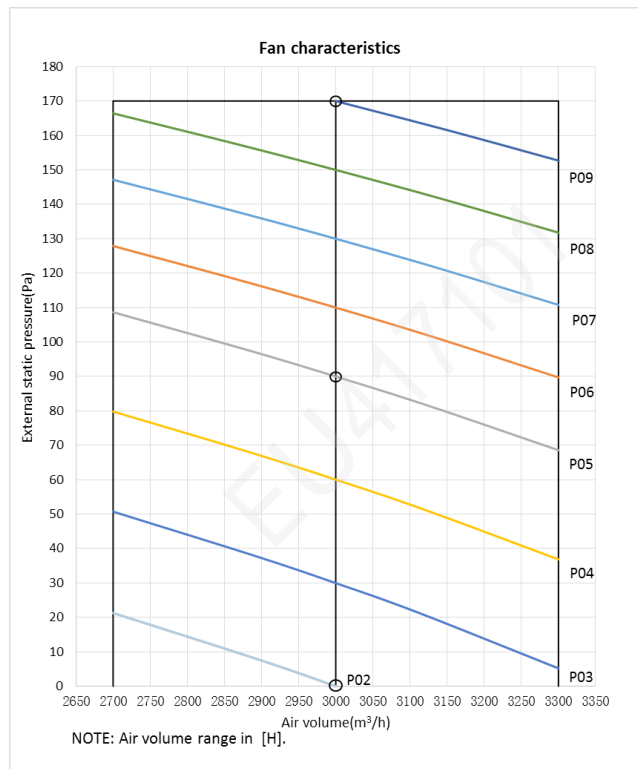



## GMV-ND224PH/A-T

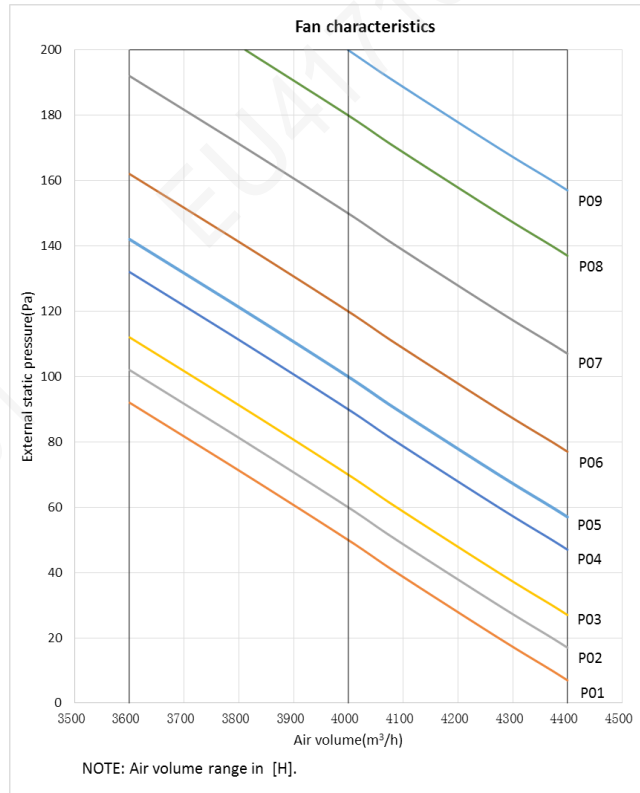

## GMV-ND280PH/A-T

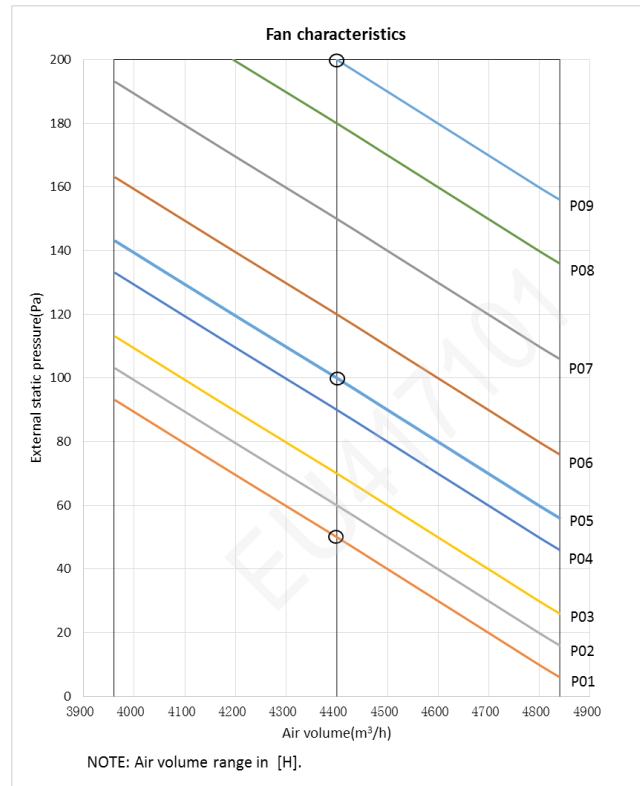

GMV-ND400PH/AR-X

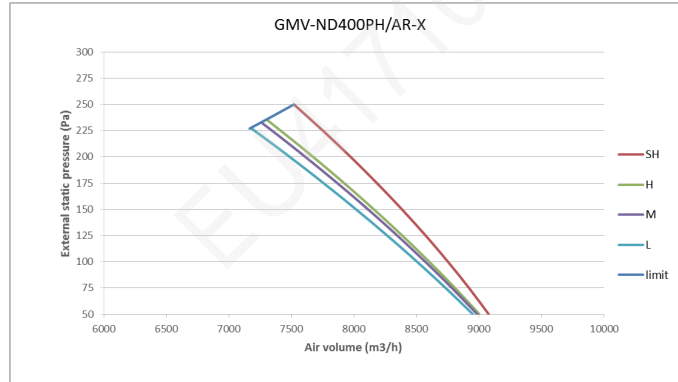

GMV-ND450PH/AR-X

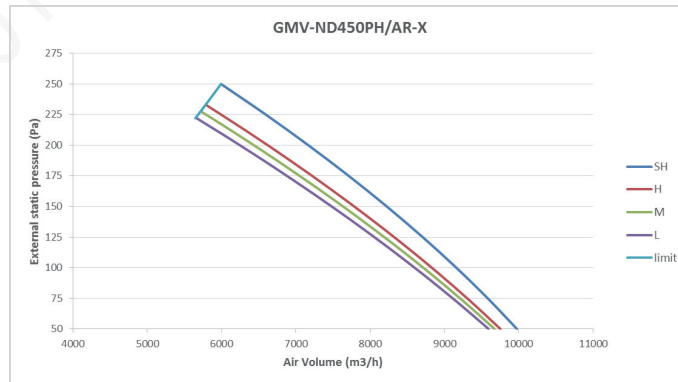

6.6 High Static Pressure Duct Type Indoor Unit

GMV-ND22PHS/D-T, GMV-ND25PHS/D-T, GMV-ND28PHS/D-T

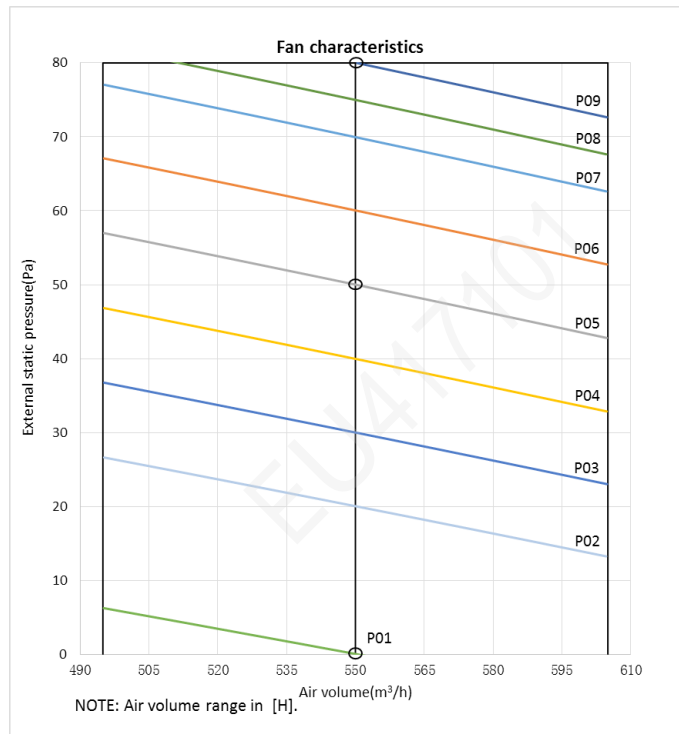

## GMV-ND32PHS/D-T, GMV-ND36PHS/D-T

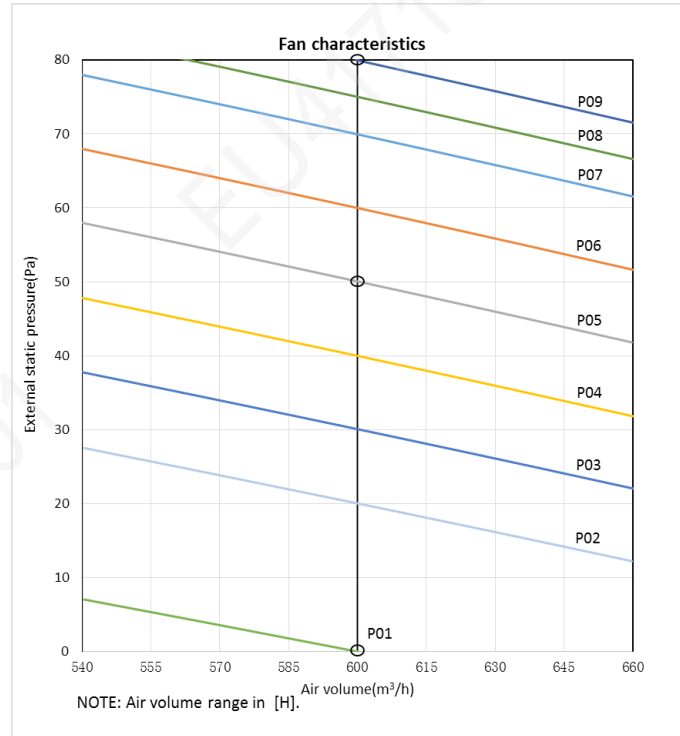

## GMV-ND40PHS/D-T, GMV-ND45PHS/D-T, GMV-ND50PHS/D-T

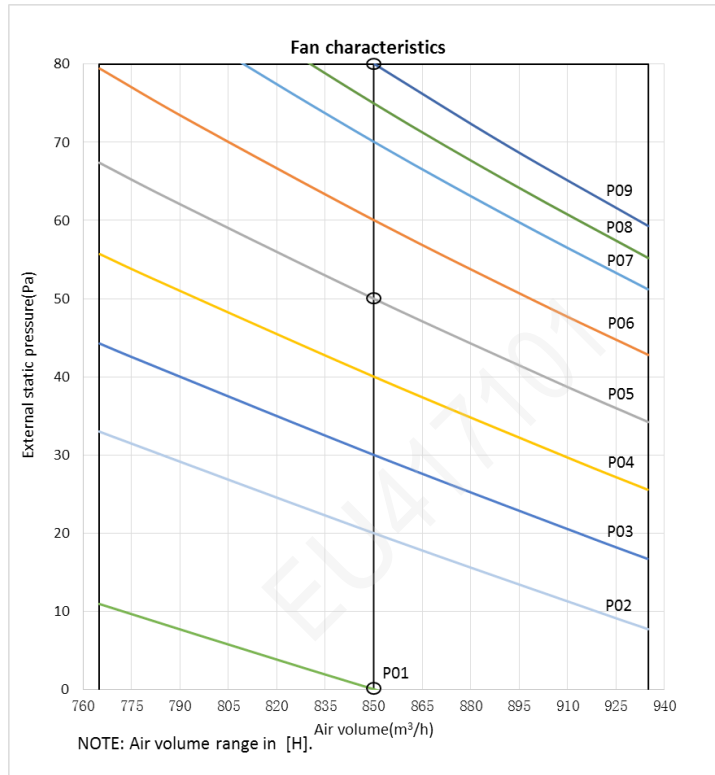

GMV-ND56PHS/D-T, GMV-ND63PHS/D-T

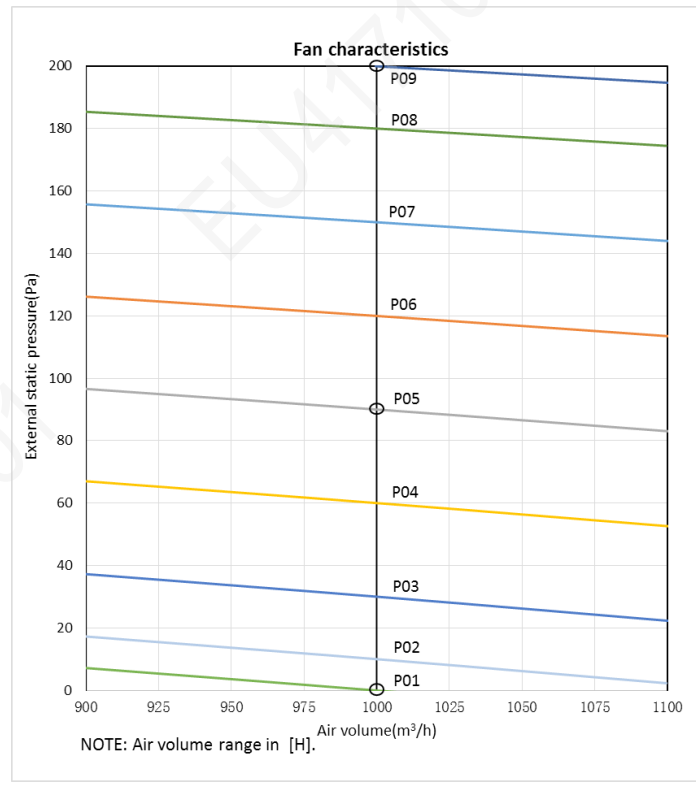

GMV-ND71PHS/D-T, GMV-ND80PHS/D-T

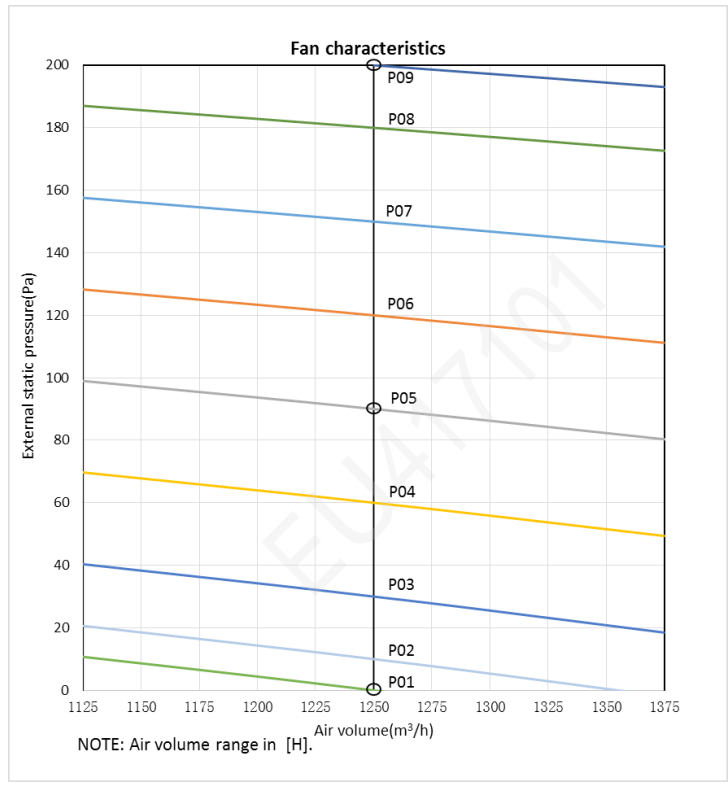

## GMV-ND90PHS/D-T, GMV-ND100PHS/D-T

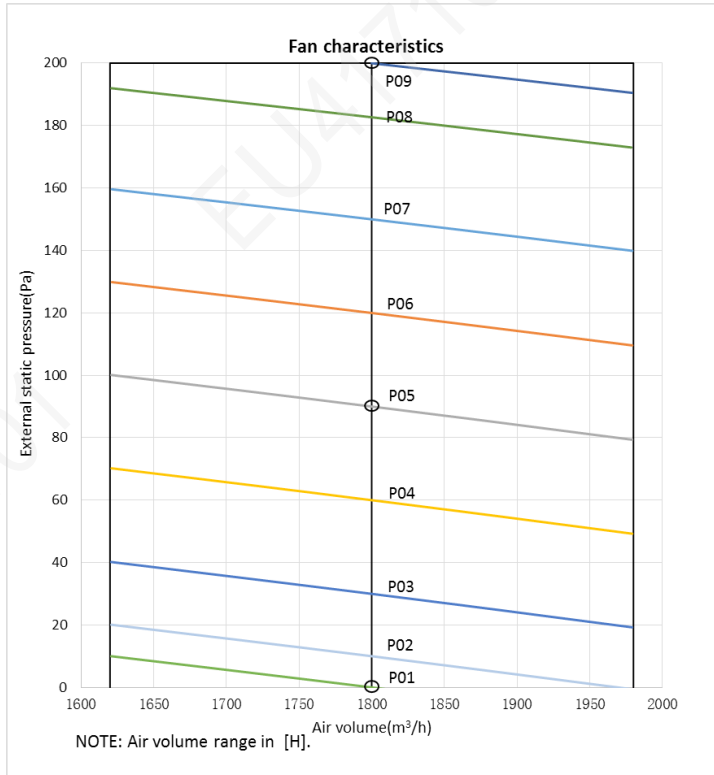

## GMV-ND112PHS/D-T, GMV-ND125PHS/D-T

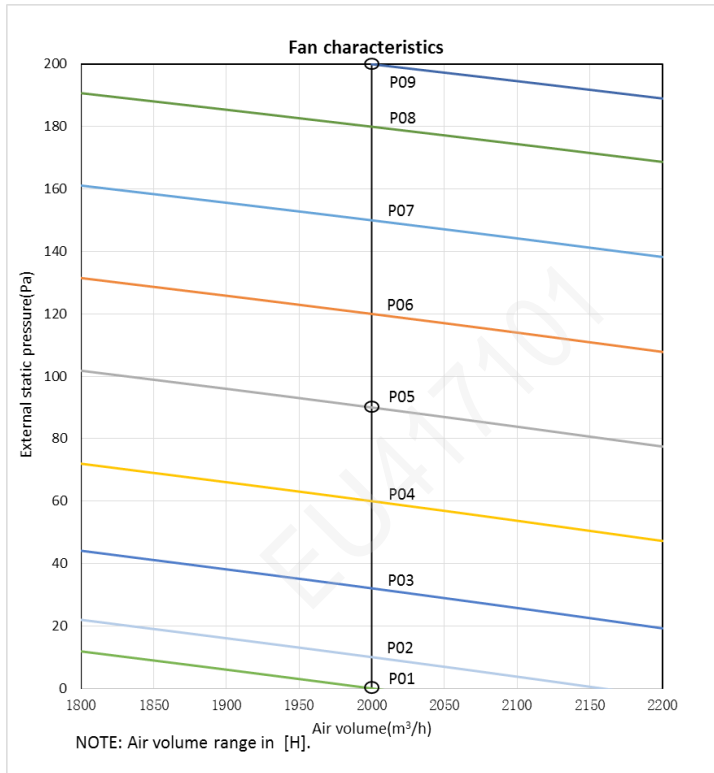

GMV-ND140PHS/D-T

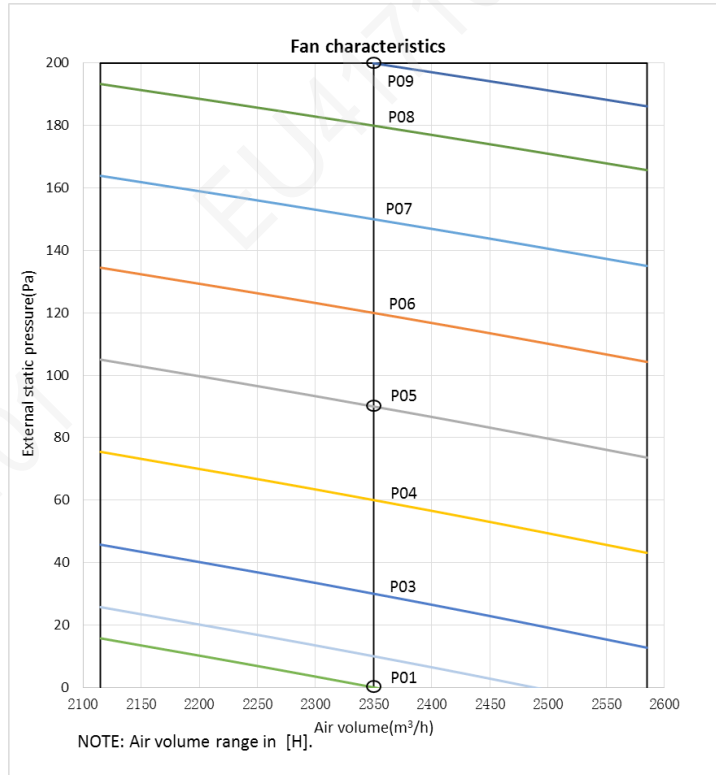

GMV-ND160PHS/D-T

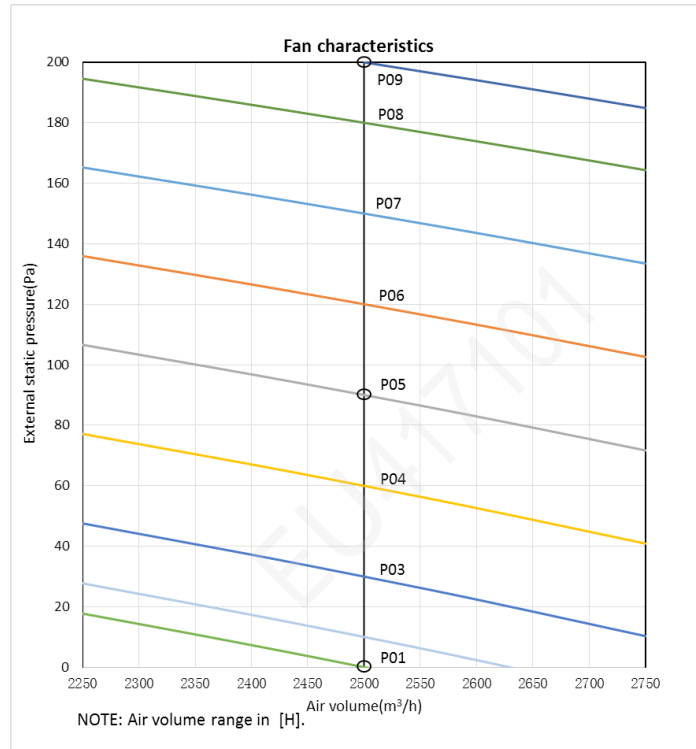

## GMV-ND180PHS/D-T

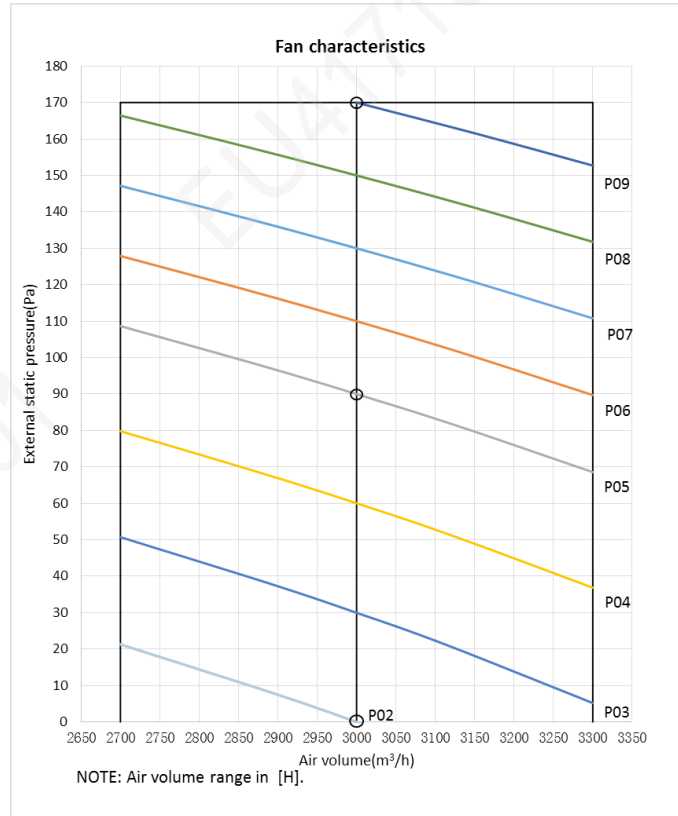

## 6.7 Middle Static Pressure Duct Type Indoor Unit

GMV-ND56PMS/A1-T, GMV-ND63PMS/A1-T, GMV-ND71PMS/A1-T

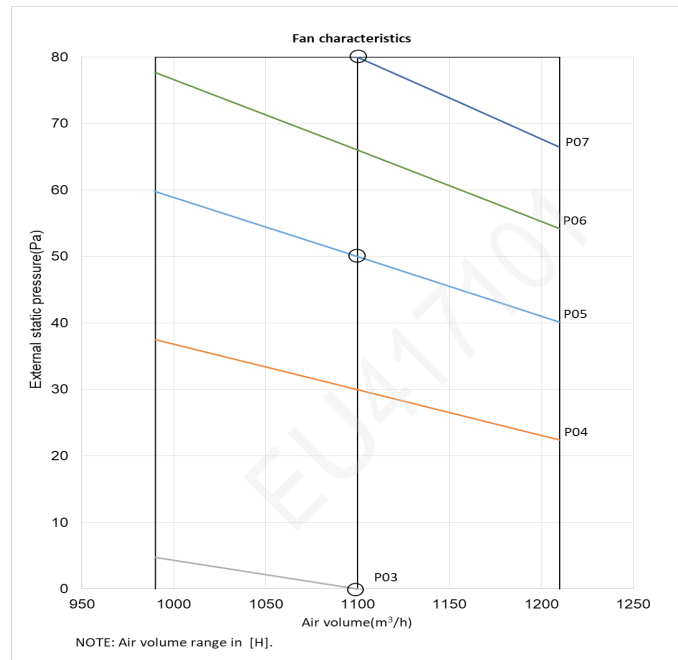



GMV-ND80PMS/A1-T

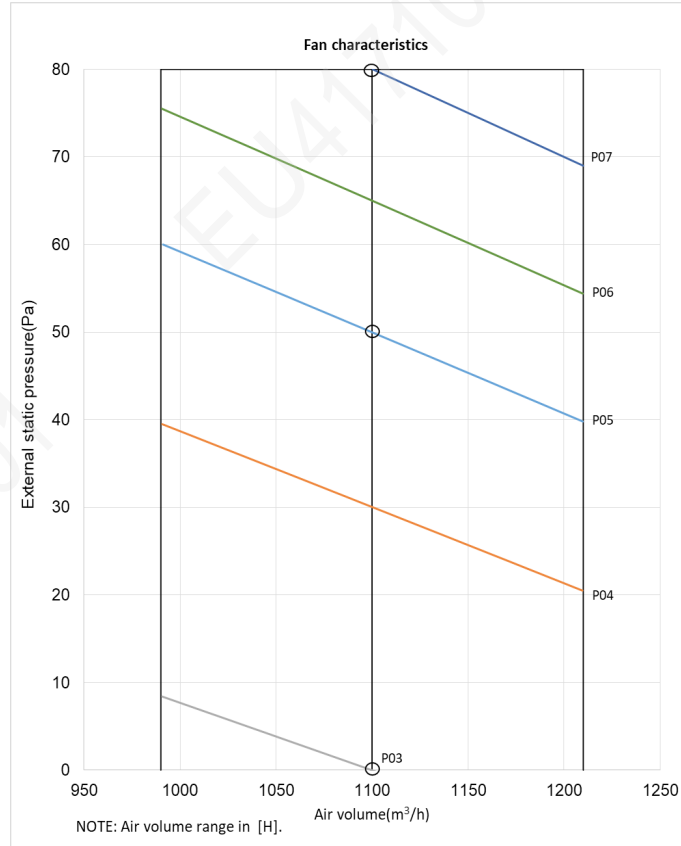

GMV-ND90PMS/A1-T, GMV-ND100PMS/A1-T, GMV-ND112PMS/A1-T

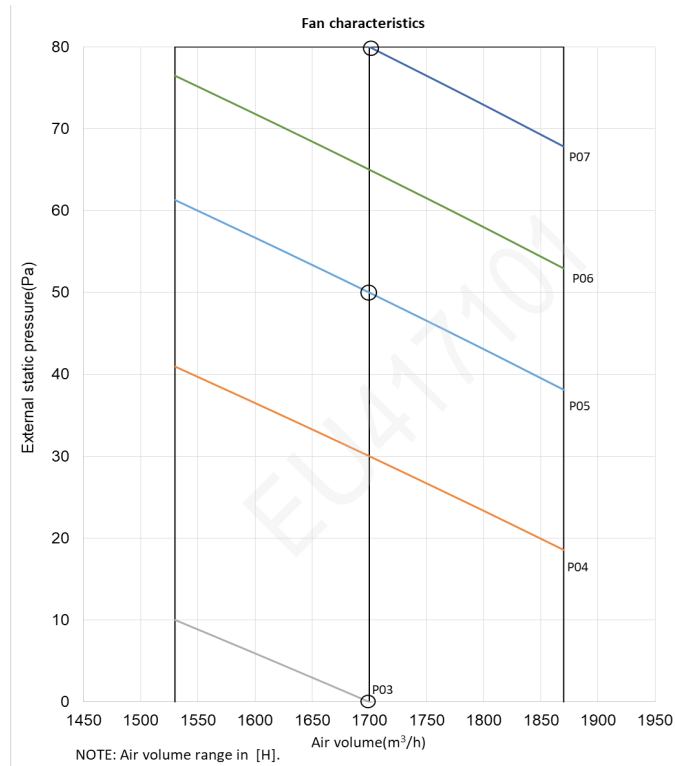

GMV-ND125PMS/A1-T, GMV-ND140PMS/A1-T

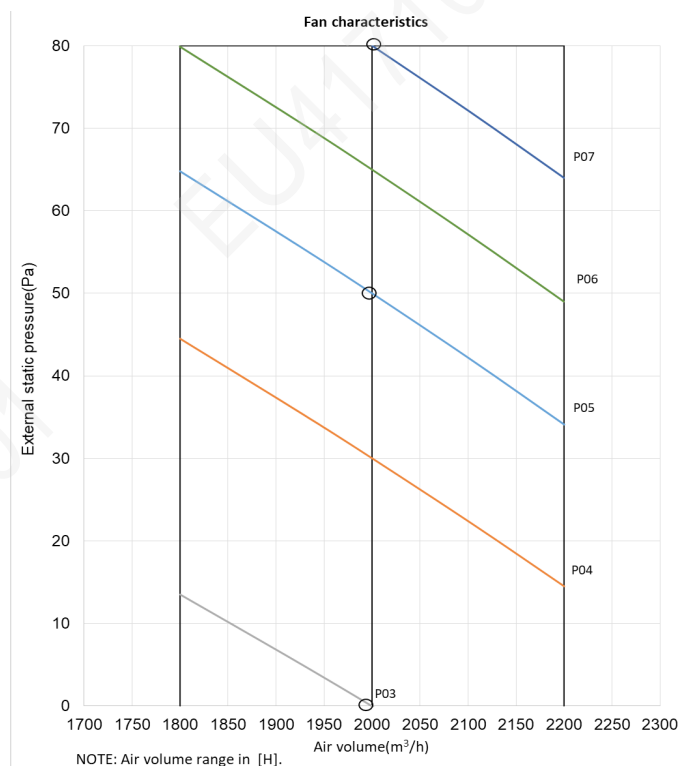

## 7 UNIT INSTALLATION SPACE REQUIREMENTS

### 7.1 Precautions on the indoor unit design

The following aspects must be specially noted in consideration of the indoor unit location:

- (1) The location should satisfy the optimal airflow organization for air conditioner in the actual project, and implement the most uniform distribution of temperature.
- (2) Avoid mixed use of air ducts for air supply and air return in different air conditioning areas.
- (3) When the indoor unit in the air supply mode of air duct is selected, it is preferred to adopt the rear air return mode for the unit to further efficiently reduce the air return noise of the unit.

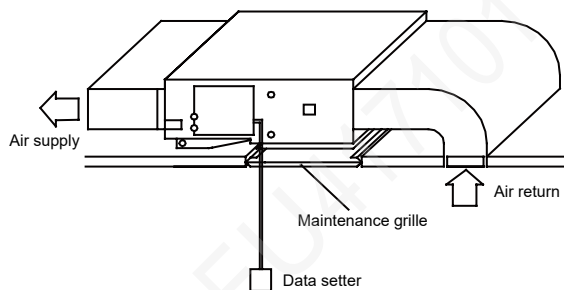

(4) In locating, consider whether air return of the unit will be affected. For the indoor unit in the air supply mode of air duct, the air return frame must be more than 300 mm away from the back wall (rear air return mode) or other barriers.

(5) If the unit uses the rear air return mode and the ceiling uses the air return mode directly below the unit, the distance between the unit bottom and the ceiling must be over 50 mm. Meanwhile, the effective circulation area between the unit bottom and the ceiling cannot be smaller than the air return

vent area of the unit. For example:

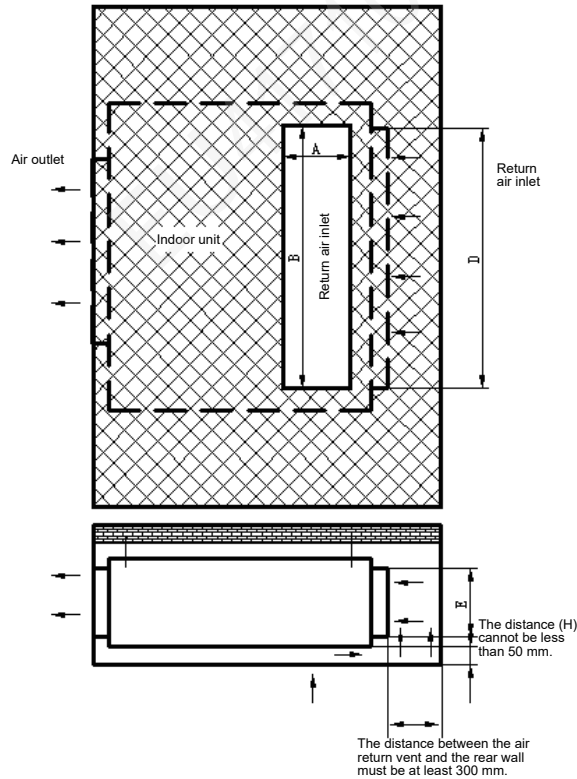

Air return area of the unit:  $S1 = D \times E$

Air return vent circumference of the ceiling:  $L = 2 \times (A + B)$

Effective air return area of the ceiling:  $S2 = L \times H$

$S2$  cannot be smaller than  $S1$ . The distance  $H$  between the ceiling and the unit cannot be smaller than 50 mm.

(6) No barrier blocking air flow should exist at the air inlet or outlet of the indoor unit. The indoor unit should be installed at a position 2.3 m higher than the floor.

(7) For the indoor unit with the rated Cooling capacity greater than 5.6 Kw, an air supply duct should be additionally added, and the air duct and air outlet should be set properly to reduce noises.

(8) A sufficient maintenance space should be reserved in locating the unit.

## 7.2 Different installation space requirements for various of indoor units

### 7.2.1 Duct Unit Series

#### 7.2.1.1 Dimensions

(1) General static pressure Duct Type

The figure below is applicable to the models of which Cooling capacity range from 1.8 kW to 7.1 kW.

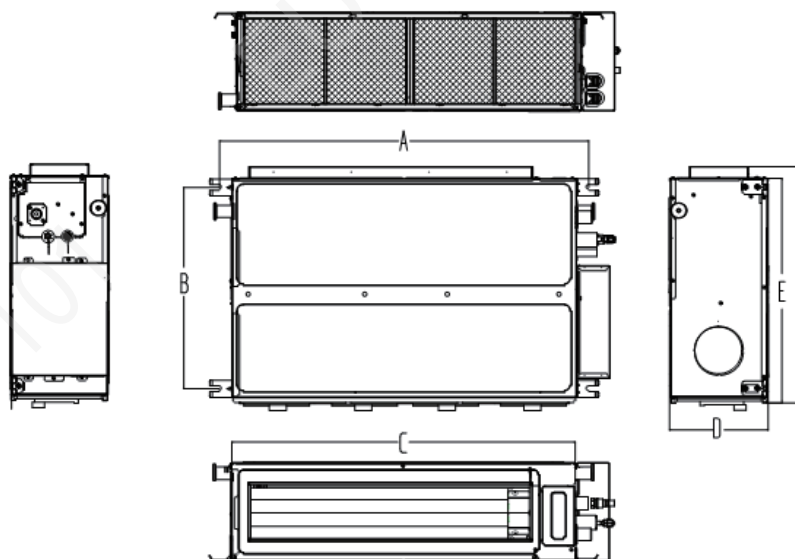

Unit: mm

Item	A	B	C	D	E	F
Model						
GMV-ND18~36PLS/C-T	760	415	710	200	462	486
GMV-ND40~63PLS/C-T	1060	415	1010	200	462	486
GMV-ND71PLS/C-T	1360	415	1310	200	462	486



## (2) Slim Duct Type series

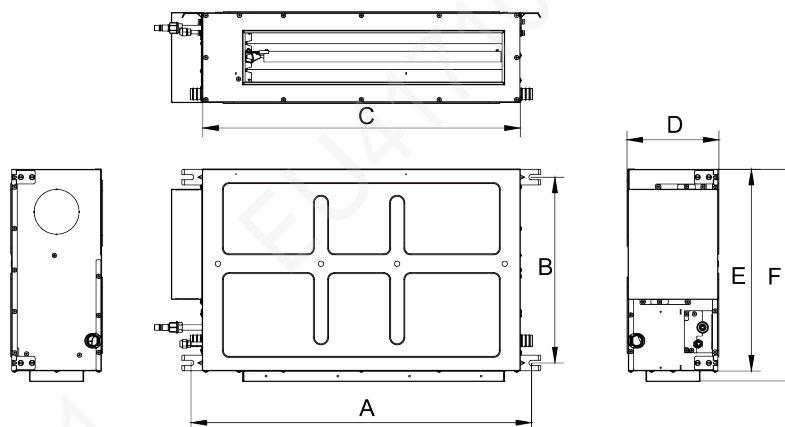

Unit: mm

Model	Item	A	B	C	D	E	F
GMV-ND22~36PL/B-T		760	415	710	200	450	475
GMV-ND40~63PL/B-T		1060	415	1010	200	450	475
GMV-ND72PL/B-T		1360	415	1310	200	450	475

## (3) Super High Static Pressure Duct Type Indoor Unit

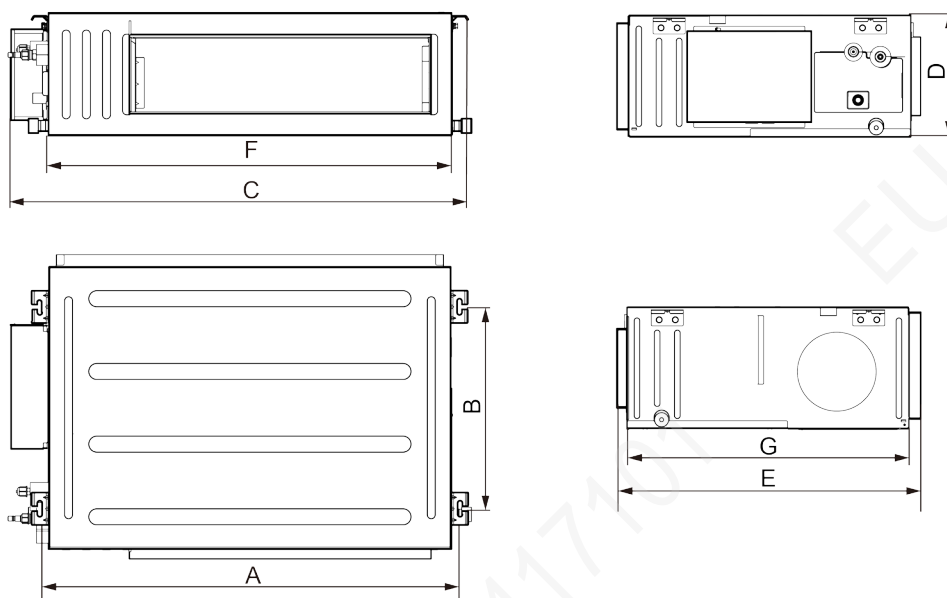

Unit: mm

Model	Item	A	B	C	D	E	F	G
GMV-ND22~50PHS/B-T		740	500	830	300	754	700	700
GMV-ND56~80PHS/B-T		1040	500	1130	300	754	1000	700
GMV-ND90~125PHS/B-T		1440	500	1530	300	754	1400	700
GMV-ND140~180PHS/B-T		1440	500	1580	300	754	1400	700

The figure below is applicable to the models of which Cooling capacity range from 22.4 kW to 28.0 kW.

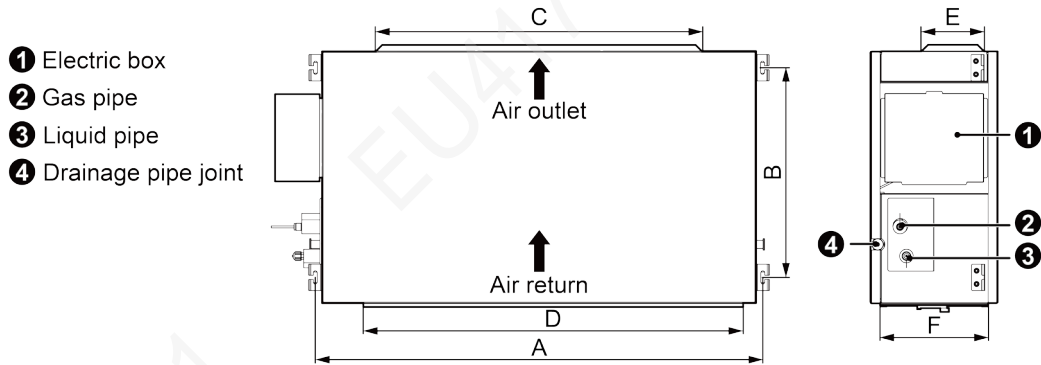

The table below lists the detailed dimensions.

Unit: mm

Model	A	B	C	D	E	F
GMV-ND224PH/A-T	1353	632	992	1150	192	327
GMV-ND280PH/A-T	1563	707	992	1350	192	402

GMV-ND400PH/AR-X:

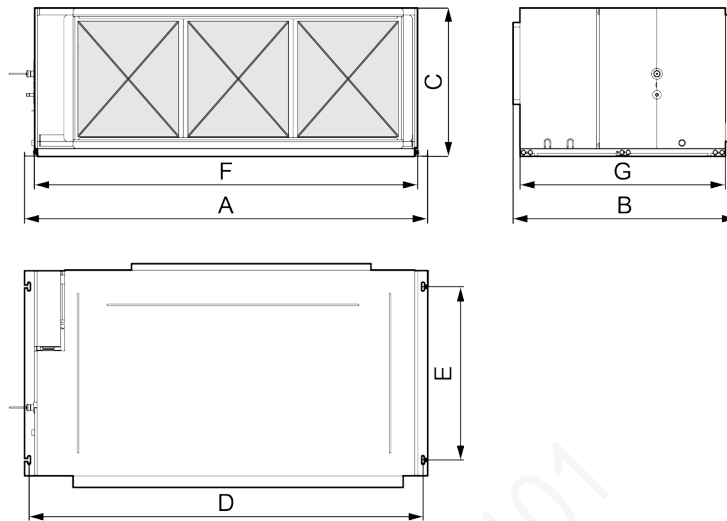

# DC INVERTER MULTI VRF INDOOR UNIT TECHNICAL SALES GUIDE

GMV-ND450PH/AR-X:

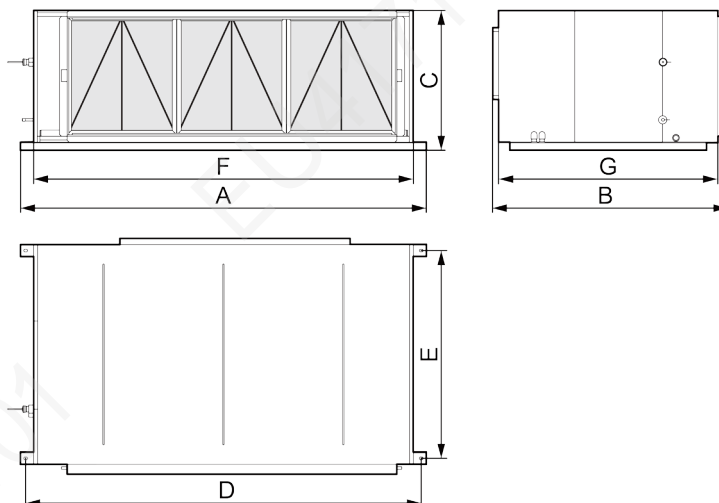

GMV-N560PH/AR-M:

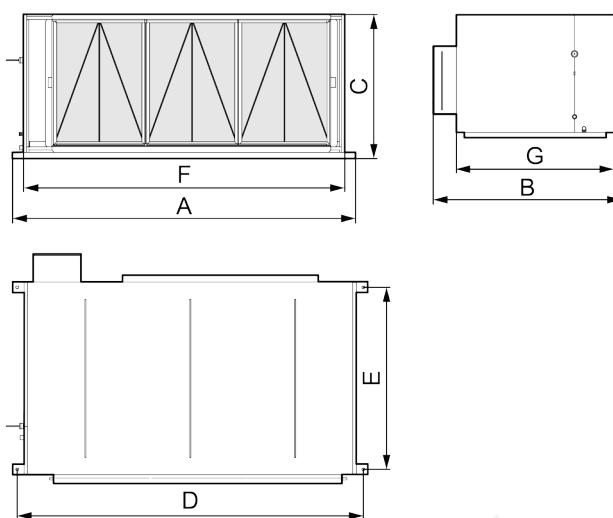

The table below lists the detailed dimensions.

Unit: mm

Model	A	B	C	D	E	F	G
GMV-ND400PH/AR-X	1770	982	650	1730	760	1680	900
GMV-ND450PH/AR-X	2030	1179	700	1980	1040	1900	1100
GMV-N560PH/AR-M	2030	1309	850	1980	1040	1900	1100



(4) High Static Pressure Duct Type Indoor Unit

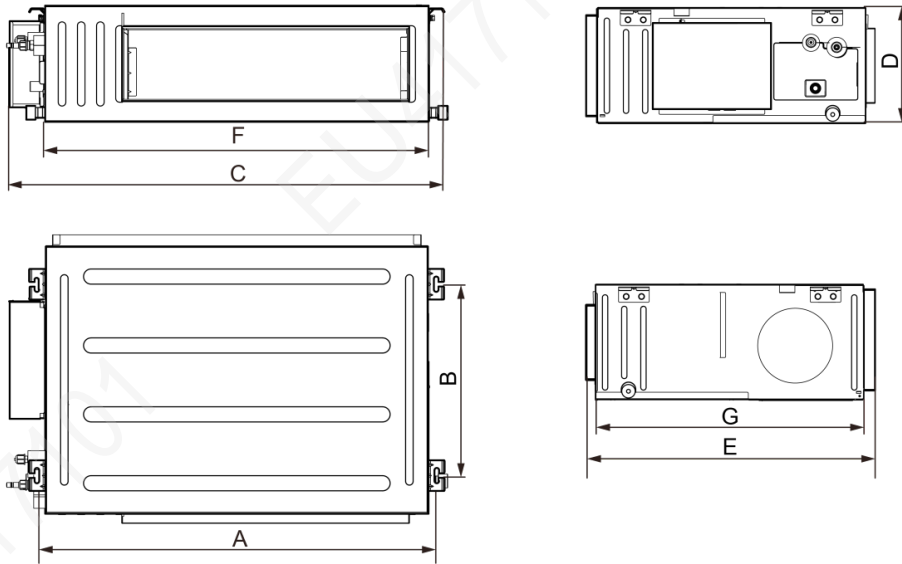

Unit: mm

Model	A	B	C	D	E	F	G
GMV-ND22~50PHS/D-T	740	500	830	300	754	700	700
GMV-ND56~80PHS/D-T	1040	500	1130	300	754	1000	700
GMV-ND90~160PHS/D-T	1440	500	1540	300	754	1400	700
GMV-ND180PHS/D-T	1440	500	1580	300	754	1400	700

## (5) Middle Static Pressure Duct Type Indoor Unit

Unit: mm

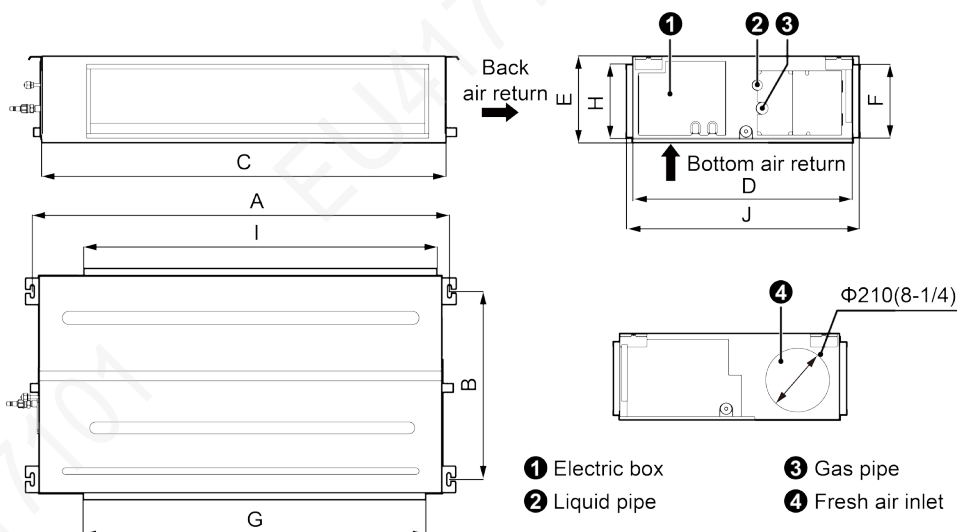

Below are dimensions of A, B, C, etc. for different models:

Unit: mm

Model	A	B	C	D	E	F	G	H	I	J
GMV-ND56PMS/A1-T	942	590	900	655	260	215	740	233	871	694
GMV-ND63PMS/A1-T										
GMV-ND71PMS/A1-T										
GMV-ND80PMS/A1-T										
GMV-ND90PMS/A1-T	1381	585	1340	655	260	215	1153	220	1188	697
GMV-ND100PMS/A1-T										
GMV-ND112PMS/A1-T										
GMV-ND125PMS/A1-T										
GMV-ND140PMS/A1-T										

### 7.2.1.2 Installation and Maintenance Spaces of Air Duct Type Units

(1) General static pressure Duct Type  
GMV-ND\*\*PLS/C-T Series

Unit: mm

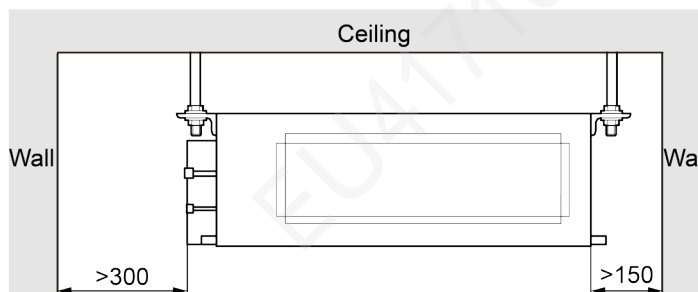

GMV-ND\*\*PLS/C1-T Series

Unit: mm

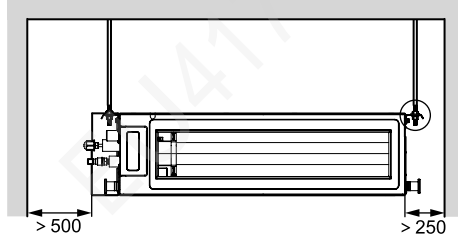

(2) Slim Duct Type GMV-ND\*\*PL/B-T Series

Unit: mm

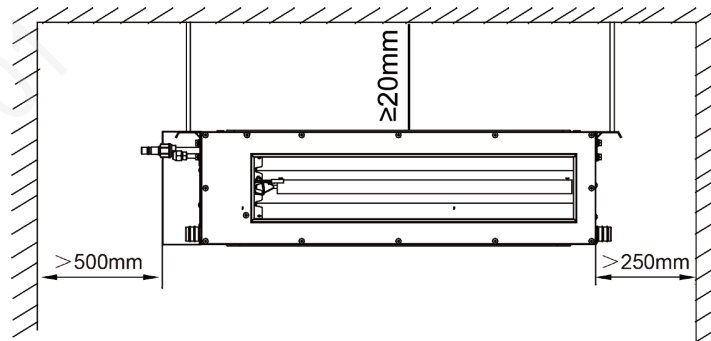

(3) Super High Static Pressure Duct Type Indoor Unit GMV-ND\*\*PH/A-T Series

Unit: mm

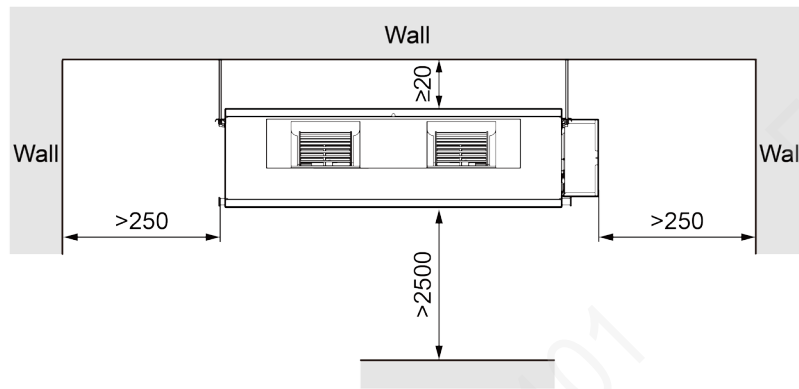

## (4) Super High Static Pressure Duct Type Indoor Unit GMV-ND\*\*PHS/B-T Series

Unit: mm

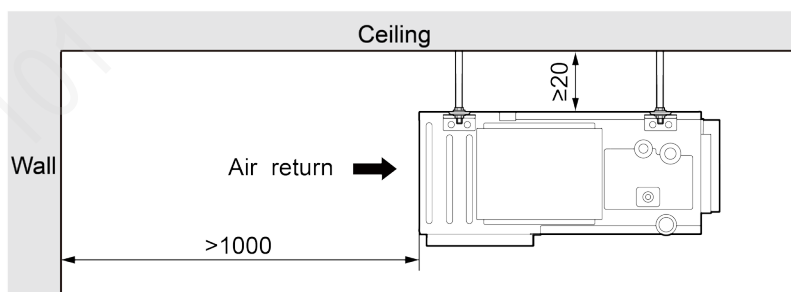
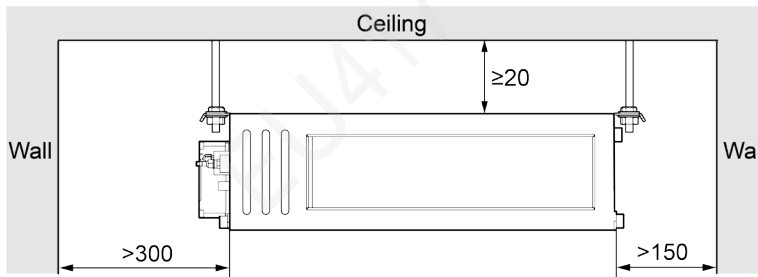

## (5) Super High Static Pressure Duct Type Indoor Unit GMV-ND\*\*PH/AR-X and GMV-N\*\*PH/AR-M Series GMV-ND400PH/AR-X

Unit: mm

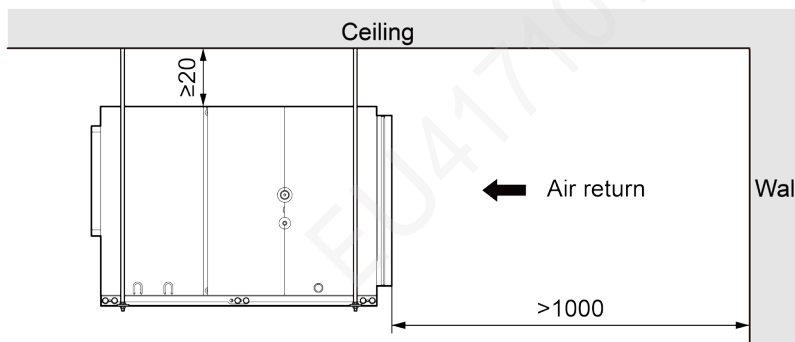
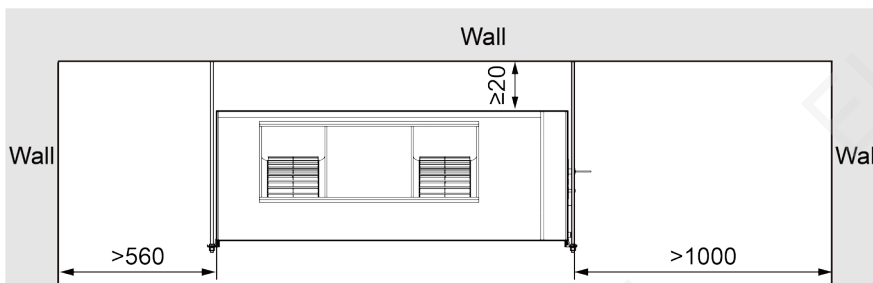

GMV-ND450PH/AR-X

Unit: mm

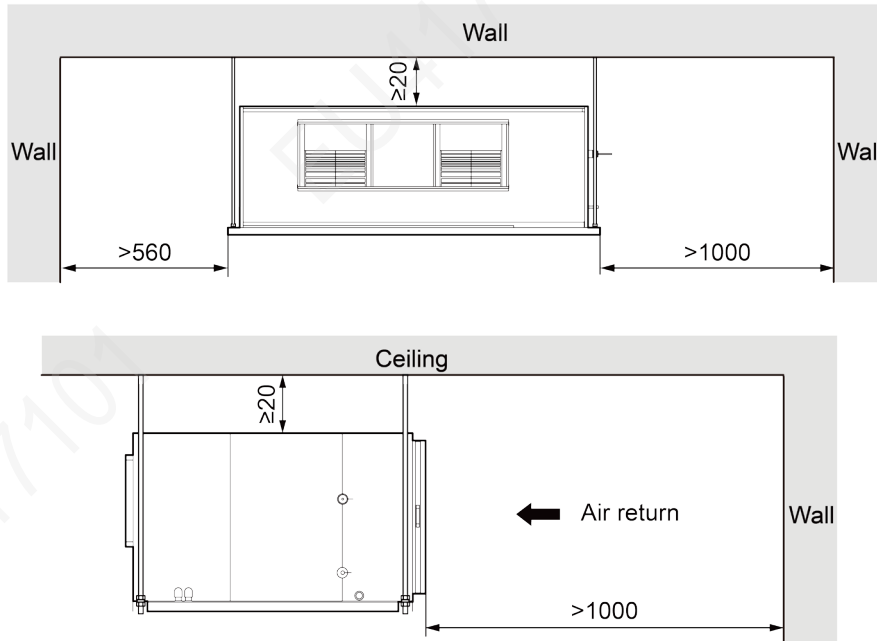

GMV-N560PH/AR-M

Unit: mm

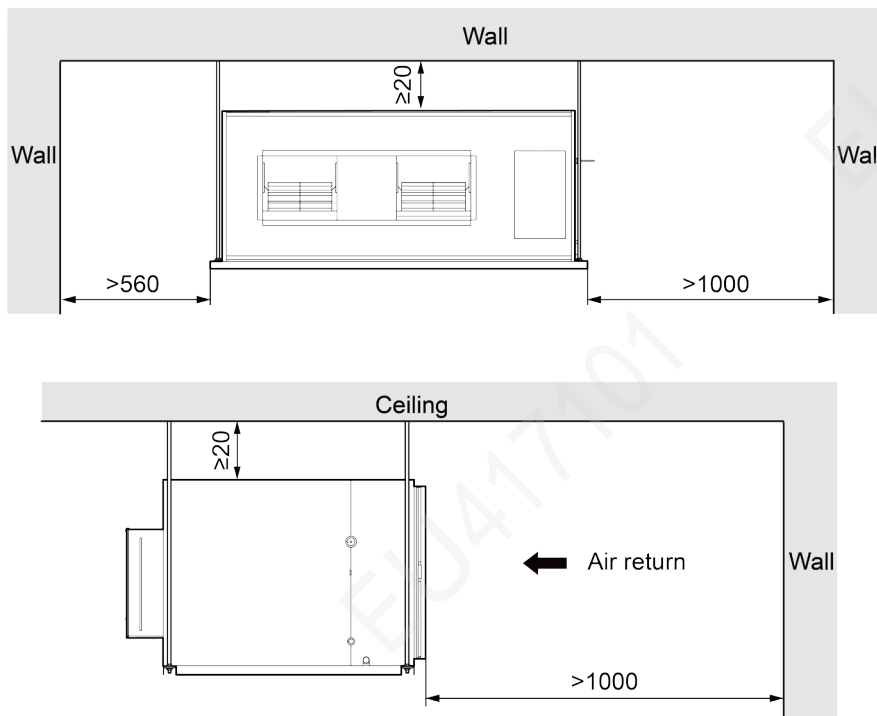

(6) High Static Pressure Duct Type Indoor Unit GMV-ND\*\*PHS/D-T Series

Unit: mm

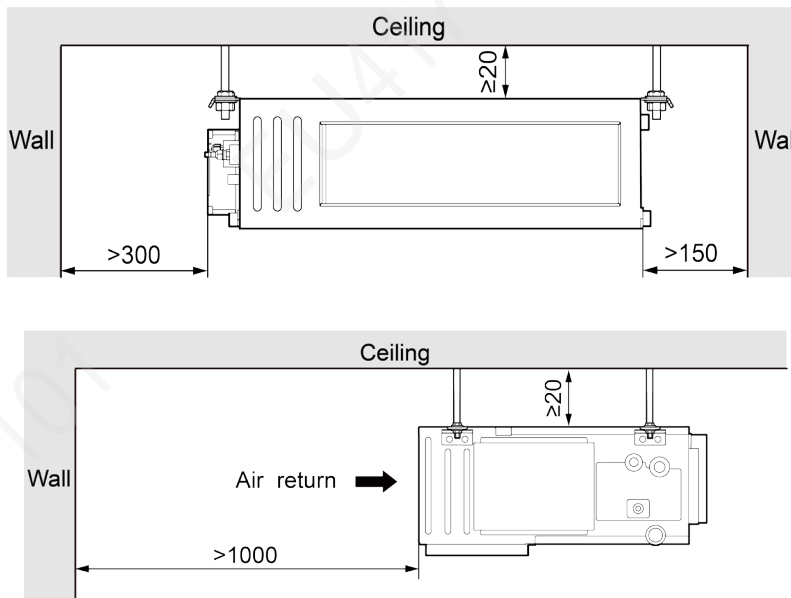

(7) Middle Static Pressure Duct Type Indoor Unit GMV-ND\*\*PMS/A1-T Series

Unit: mm

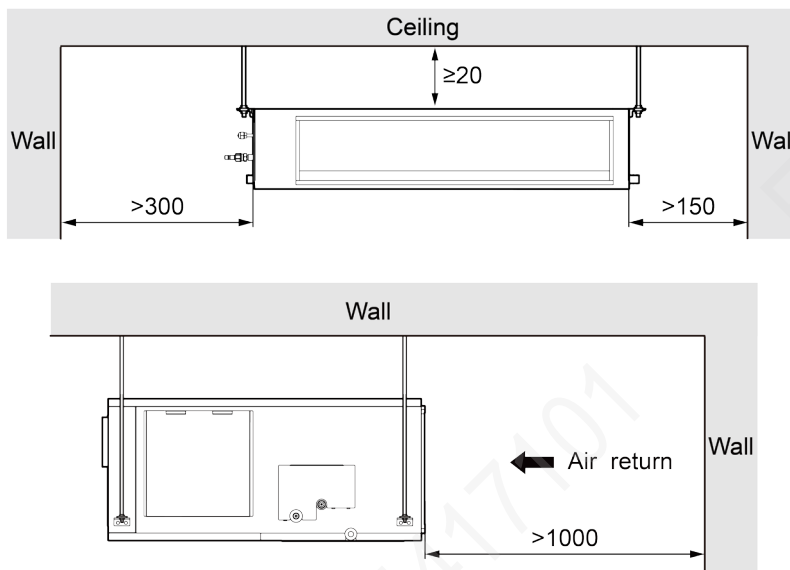

### 7.2.1.3 Shape and Size of Air Outlet and Air-return Opening

(1) General static pressure Duct Type Series

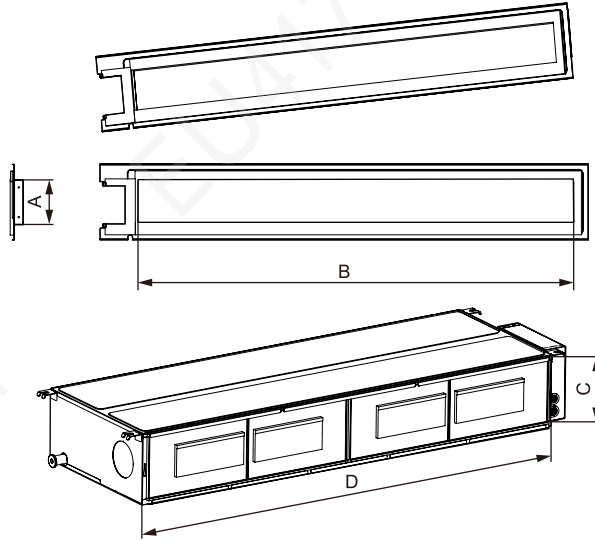

Unit: mm

Model	Item	Dimension of air outlet flange		Dimension of air return	
		A	B	C	D
GMV-ND18~36PLS/C-T		122	585	200	710
GMV-ND40~63PLS/C-T		122	885	200	1010
GMV-ND71~80PLS/C-T		122	1185	200	1310

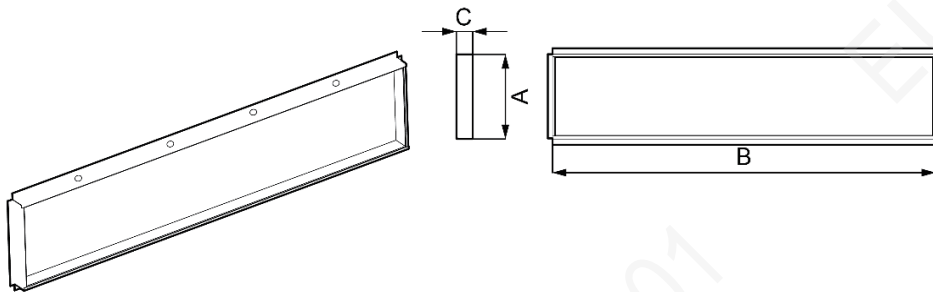

Air Outlet

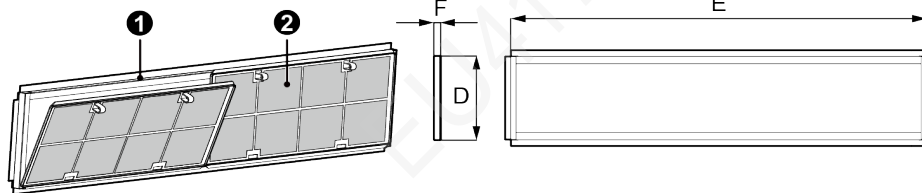

① Air-return Frame Assembly

② Filter

Air-return Opening

# DC INVERTER MULTI VRF INDOOR UNIT TECHNICAL SALES GUIDE

Unit: mm

Model	Dimension of Air Outlet			Dimension of Air-return Opening		
	A	B	C	D	E	F
GMV-ND80PLS/C-T	222	1016	21	1050	220	21
GMV-ND90PLS/C-T	207	1153	40	1188	220	22
GMV-ND100PLS/C-T						
GMV-ND112PLS/C-T						
GMV-ND125PLS/C-T						
GMV-ND140PLS/C-T						

(2) Super High Static Pressure Duct Type Indoor Unit

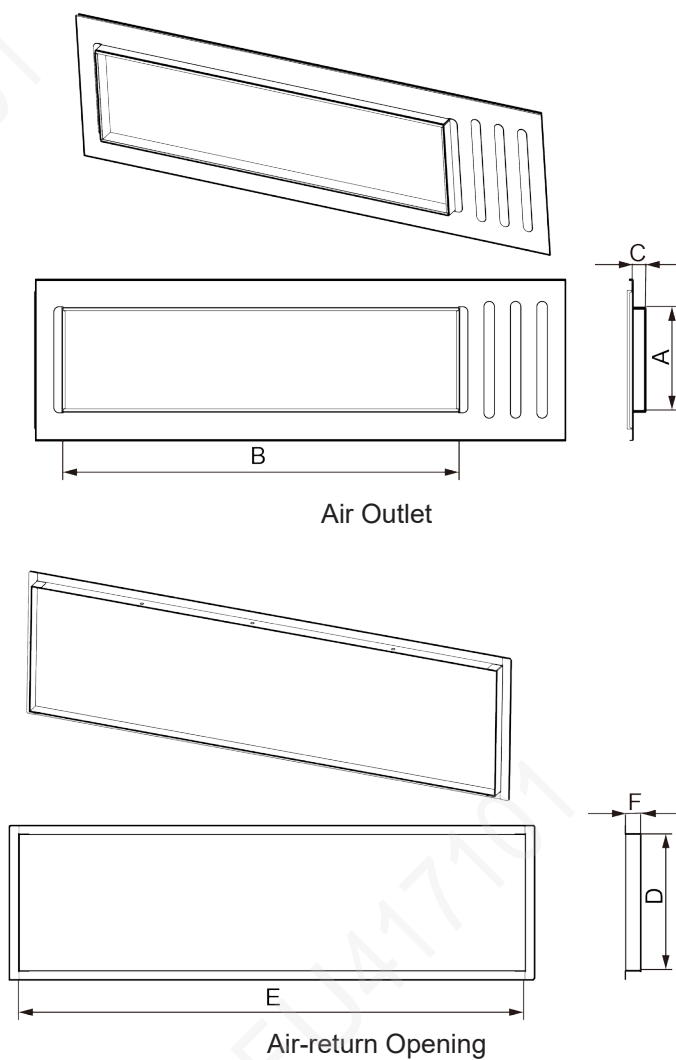

Unit: mm

Model	Dimension of Air Outlet			Dimension of Air-return Opening		
	A	B	C	D	E	F
GMV-ND22~50PHS/B-T	195	451	25	264	660	29
GMV-ND56~80PHS/B-T	195	751	25	264	960	29
GMV-ND90~180PHS/B-T	195	1151	25	264	1360	29



Unit: mm

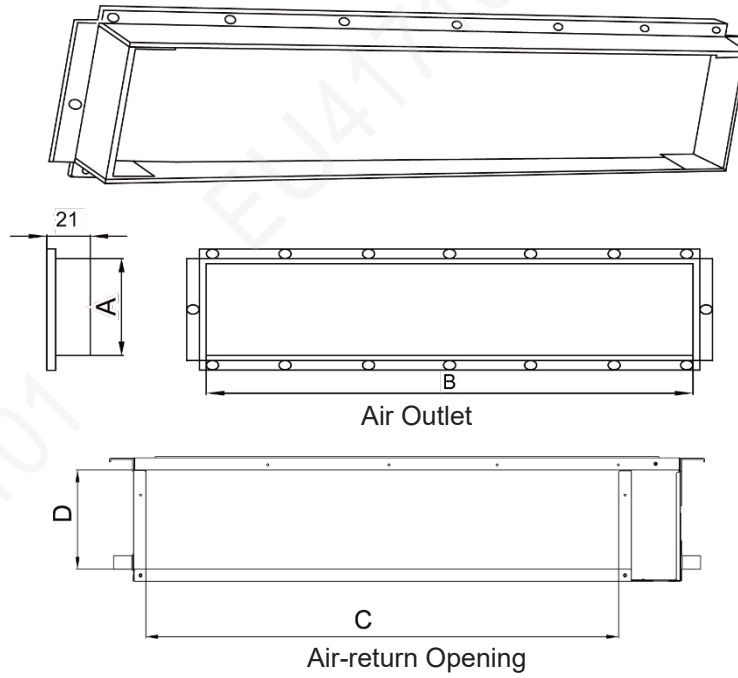

Unit: mm

Model	Dimension of Air Outlet		Dimension of Air-return Opening	
	A	B	C	D
GMV-ND224PH/A-T	192	992	1150	327
GMV-ND280PH/A-T	192	992	1350	402

GMV-ND400PH/AR-X

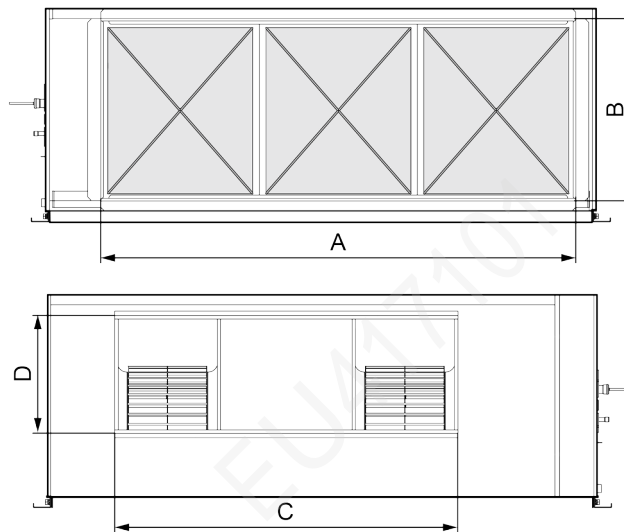

# DC INVERTER MULTI VRF INDOOR UNIT TECHNICAL SALES GUIDE

GMV-ND450PH/AR-X

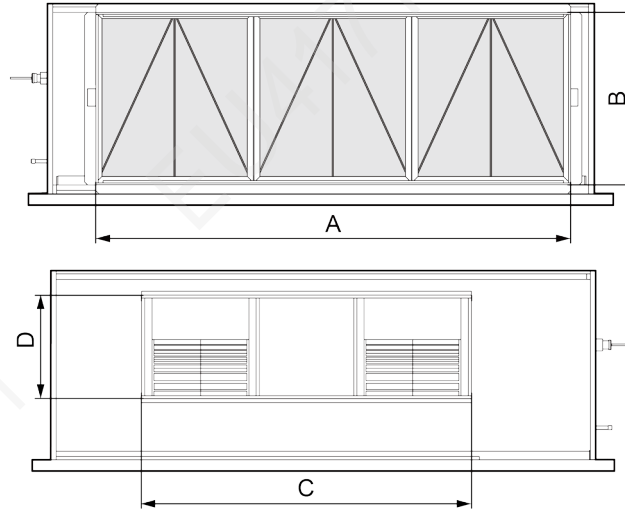

GMV-N560PH/AR-M

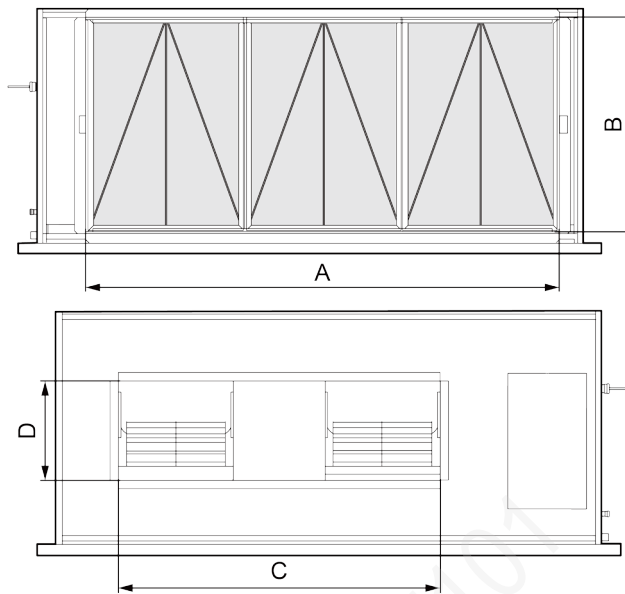

Unit: mm

Model	Dimension of Air Outlet		Dimension of Air-return Opening	
	A	B	C	D
GMV-ND400PH/AR-X	1450	557	1050	359
GMV-ND450PH/AR-X	1650	602	1155	359
GMV-N560PH/AR-M	1650	755	1120	347

(3) High Static Pressure Duct Type Indoor Unit

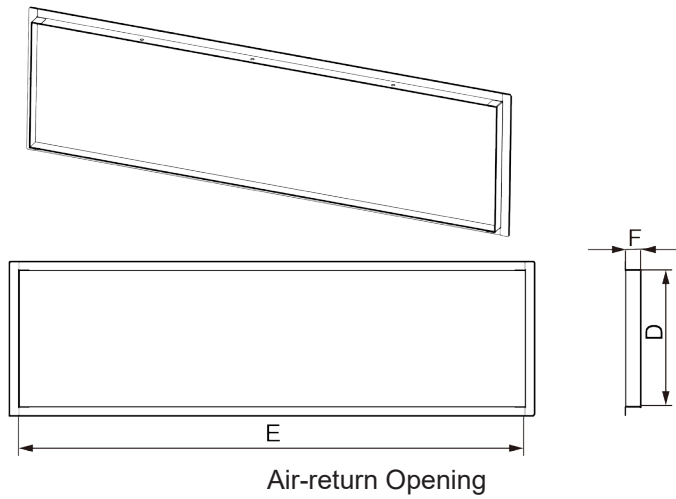
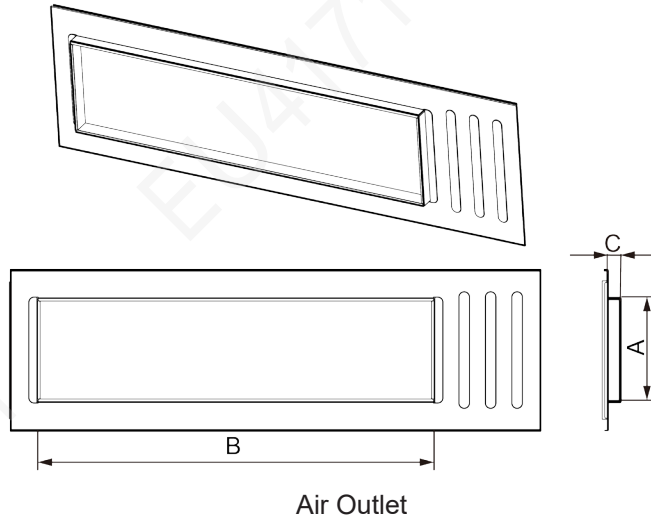

Unit: mm

Model	Dimension of Air Outlet			Dimension of Air-return Opening		
	A	B	C	D	E	F
GMV-ND22~50PHS/D-T	195	451	25	264	660	29
GMV-ND56~80PHS/D-T	195	751	25	264	960	29
GMV-ND90~180PHS/D-T	195	1151	25	264	1360	29

## (4) Middle Static Pressure Duct Type Indoor Unit

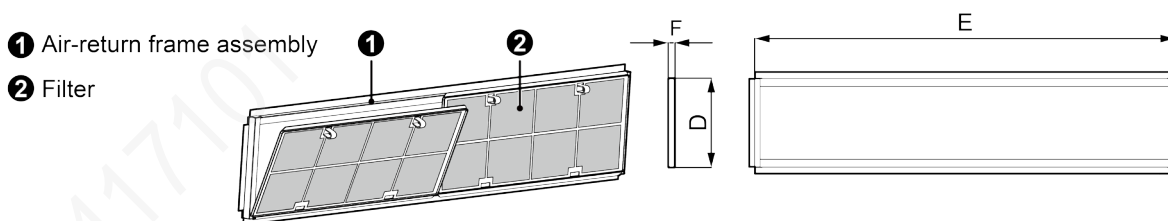
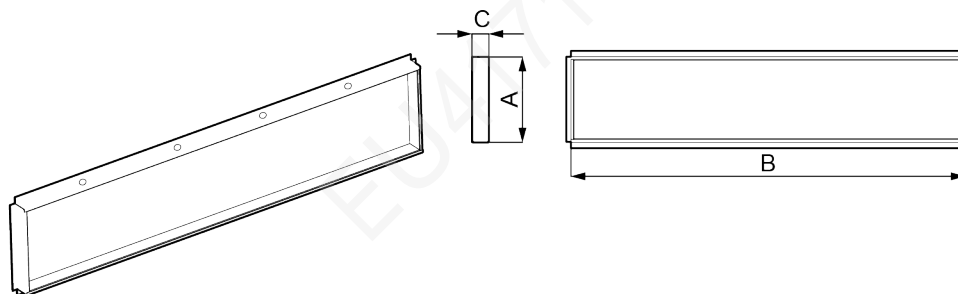

- ❶ Air-return frame assembly
- ❷ Filter

Unit: mm

Model	Dimension of Air Outlet			Dimension of Air-return Opening		
	A	B	C	D	E	F
GMV-ND56PMS/A1-T	215	740	20	233	871	18
GMV-ND63PMS/A1-T						
GMV-ND71PMS/A1-T						
GMV-ND80PMS/A1-T						
GMV-ND90PMS/A1-T	215	1153	23	220	1188	22
GMV-ND100PMS/A1-T						
GMV-ND112PMS/A1-T						
GMV-ND125PMS/A1-T						
GMV-ND140PMS/A1-T						

### 7.2.1.4 Installing Air Supply Ducts

#### (1) Installing the rectangular air duct

- ❶ Hanger rod
- ❷ Return air duct
- ❸ Canvas duct
- ❹ Return air inlet
- ❺ Static pressure box
- ❻ Main supply air duct
- ❼ Supply air outlet

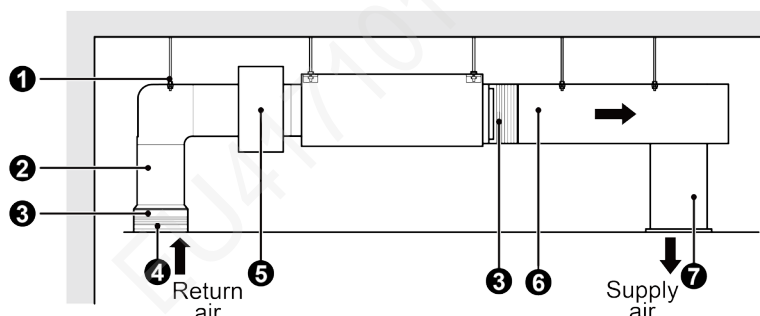

The above figure indicates only installation of the rear air return vent. The bottom air return vent can also be used according to the actual installation requirement, and the installation method is similar to the method of installing the rear air return vent. The air supply duct is a rectangular air duct, which is connected to the air outlet of indoor unit. At least one of all the air supply outlets should be kept open. The air supply outlet and air return vent joint, and the air return vent and air supply outlet joint

are connected using canvas (select canvas with thermal insulation effect). When there are static pressure and low noise requirements, a plenum box is connected between the air supply outlet and the air supply duct. The air outlet dimension of the plenum box is consistent with the air supply outlet dimension. The plenum box is connected to the air supply outlet using canvas.

If the rear air return mode is used, a space for installing the return duct is reserved in the suspended air duct indoor unit. The air return vent dimension should be as large as possible, and the air speed should be as low as possible.

(2) Installing the circular air duct

- ❶ Return air duct
- ❷ Canvas duct
- ❸ Return air blinds
- ❹ Hanger rod
- ❺ Supply air outlet
- ❻ Transition pipe
- ❼ Supply air duct
- ❽ Diffuser
- ❾ Diffuser connector

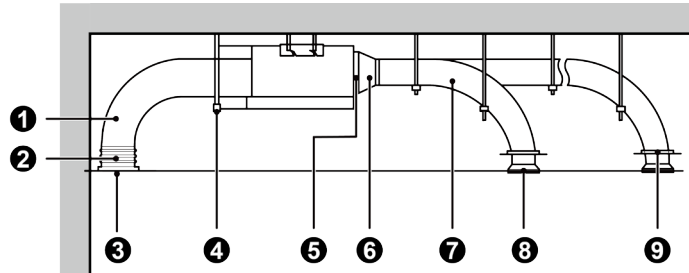

Notes:

- ❶ The maximum air duct length refers to the total length of the air supply duct of the farthest air supply outlet plus the total length of the return duct of the corresponding farthest return air inlet.
- ❷ To connect the unit with auxiliary electric heating to a circular air duct, the straight length of the transition air duct should be at least 200 mm.

◆ Installation procedure of the circular air duct

- 1) Pre-install the circular air outlet at the transition air duct, and use self tapping screws to fasten it.
- 2) Cover the air outlet of the unit with the transition air duct, and use rivets to connect them.
- 3) Cover the circular air outlet with the duct outlet, and use a band to tie them tightly. Then, the circular air duct is connected to the unit. Other operations are omitted here.

**7.2.1.5 Installing Air Return Duct**

(1) The unit is the rear air return mode before delivery, and the air return cover is installed at the bottom part, as shown below.

(2) If bottom air return is required, exchange the position of the square flange with that of the air return cover.

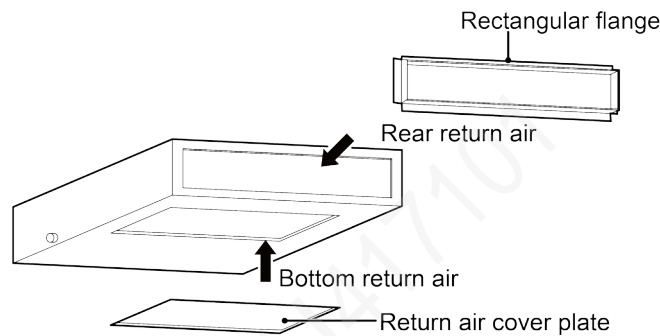

(3) Use rivets to connect the return duct to the air return vent of the indoor unit, and connect the other end to the air return vent. To freely adjust the height, prepare a section of canvas air duct, use 8# iron wire to reinforce the duct, and fold it.

Select bottom air return or rear air return mode according to the installation and maintenance spaces, and install the return duct as shown below.

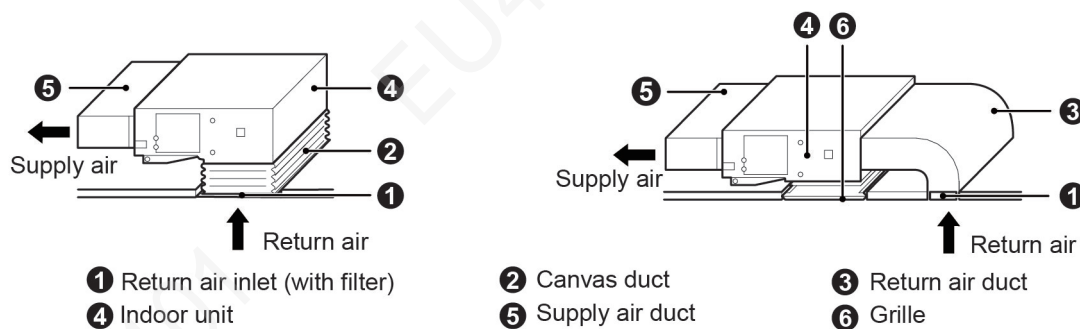

Notes:

- ① Since the bottom air return mode generates more noises than the bottom air return mode does, the bottom air return mode is not recommended.
- ② Usually the bottom air return mode is adopted for the site with a small installation space.

### 7.2.1.6 Installing Fresh Air Duct

(1) To connect a fresh air duct, first cut off the fresh air baffle, as shown in the left part of the following figure. If you do not want to use the fresh air duct, use sponge to block the fresh air baffle gap.

(2) Install the circular flange to connect to the fresh air duct, as shown in the right part of the following figure.

(3) Both the air duct and the circular flange should be well sealed and insulated.

(4) Fresh air must be filtered air.

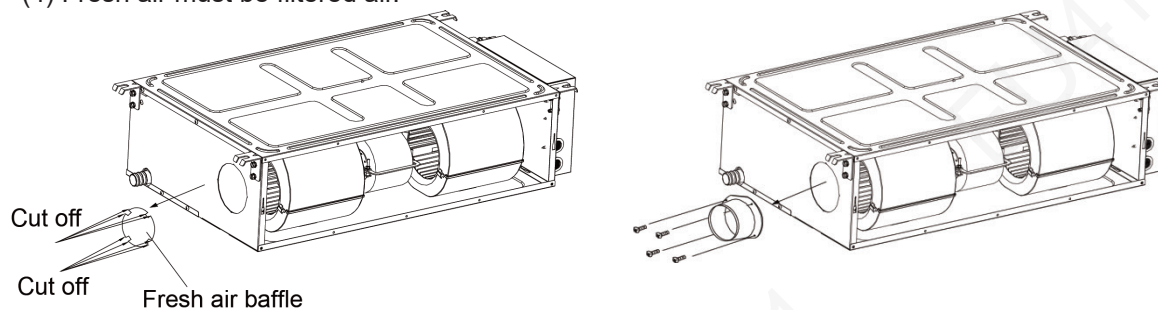

Notes:

- ① Both the air supply duct and return duct should be provided with an insulating layer to prevent heat loss and condensation.
- ② All the air supply ducts and return ducts should be fastened on the floor precast slab using iron supporters, and the air duct joints should be sealed properly using glue to prevent air leakage.
- ③ The air duct design and construction must comply with the relevant engineering specification requirements of the state.
- ④ The recommended distance between the return duct edge and the wall is over 150 mm, and a filter should be installed at the air return vent.
- ⑤ Measures for noise reduction and shock absorption should be taken into account in air duct design and construction.

### 7.2.2 Four-way Cassette Type

Requirements for external dimensions and installation and maintenance spaces.

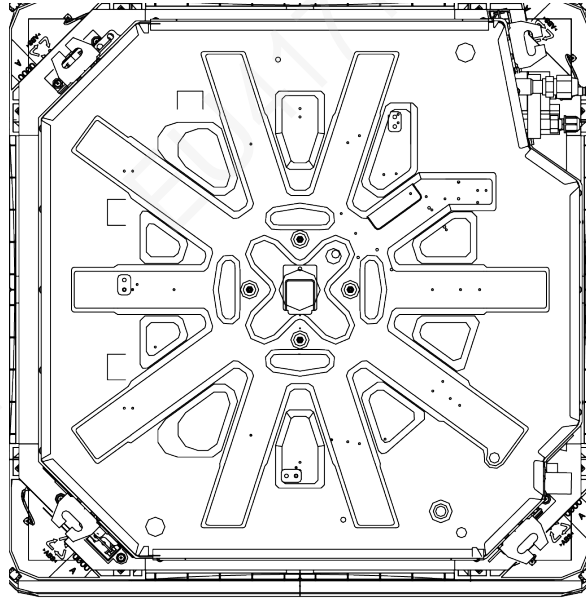

A(decoration panel)

Unit: mm

Model	A
GMV-ND28~140T/A-T	950

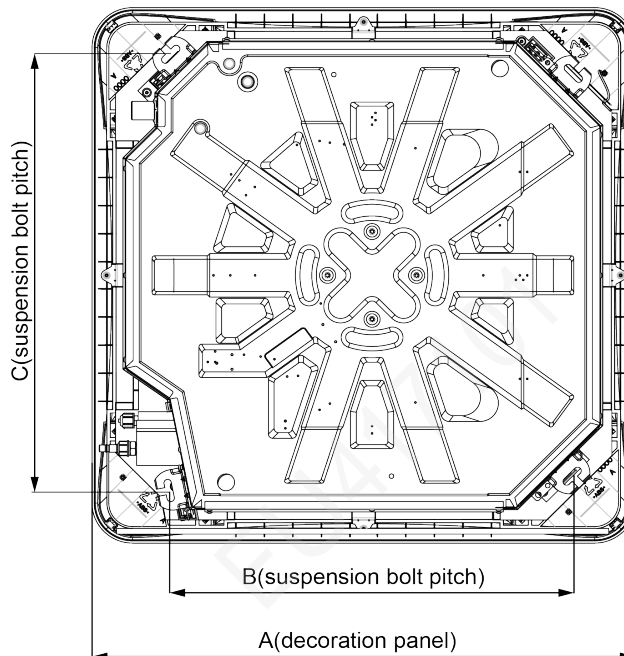

Unit: mm

Model	A	B	C
GMV-ND160T/A-T	1040	790	840

Unit: mm

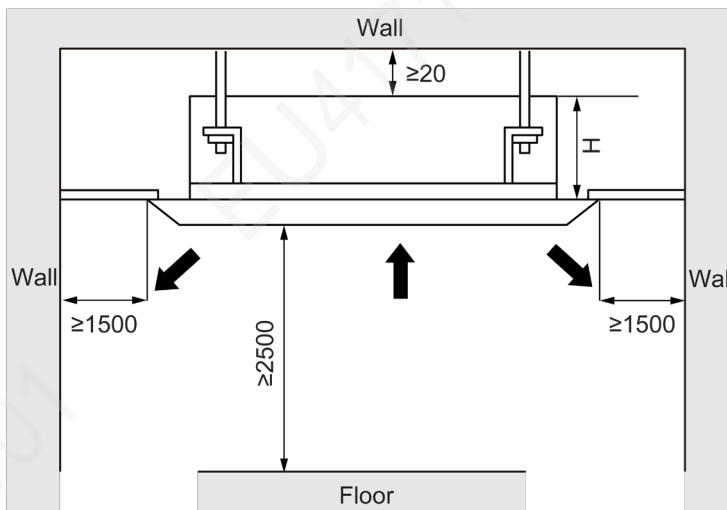

Unit: mm

Model	H
GMV-ND28~50T/A-T	220
GMV-ND56~80T/A-T	270
GMV-ND90~140T/A-T	350
GMV-ND160T/A-T	310

### 7.2.3 One-way Cassette Type

Requirements for external dimensions and installation and maintenance spaces.  
External Dimensions

Unit: mm

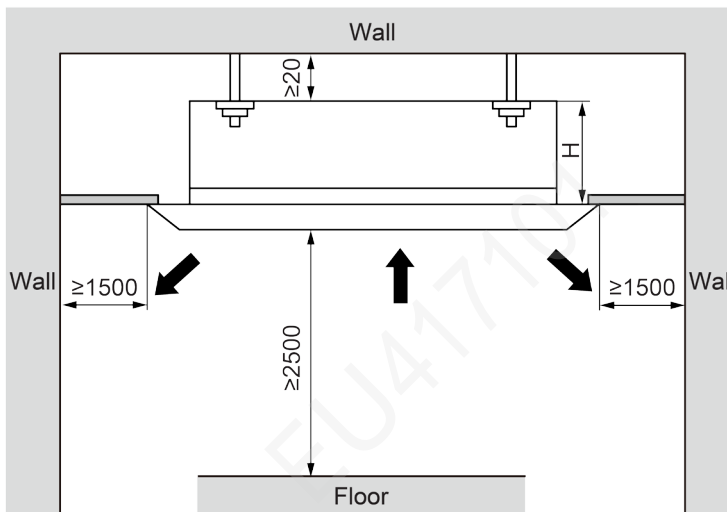

Models:	H(mm)
GMV-ND22~56TD/A-T	207
GMV-ND63~80TD/B-T	200



Installation and Maintenance Spaces

Unit: mm

GMV-ND22~56TD/A-T:

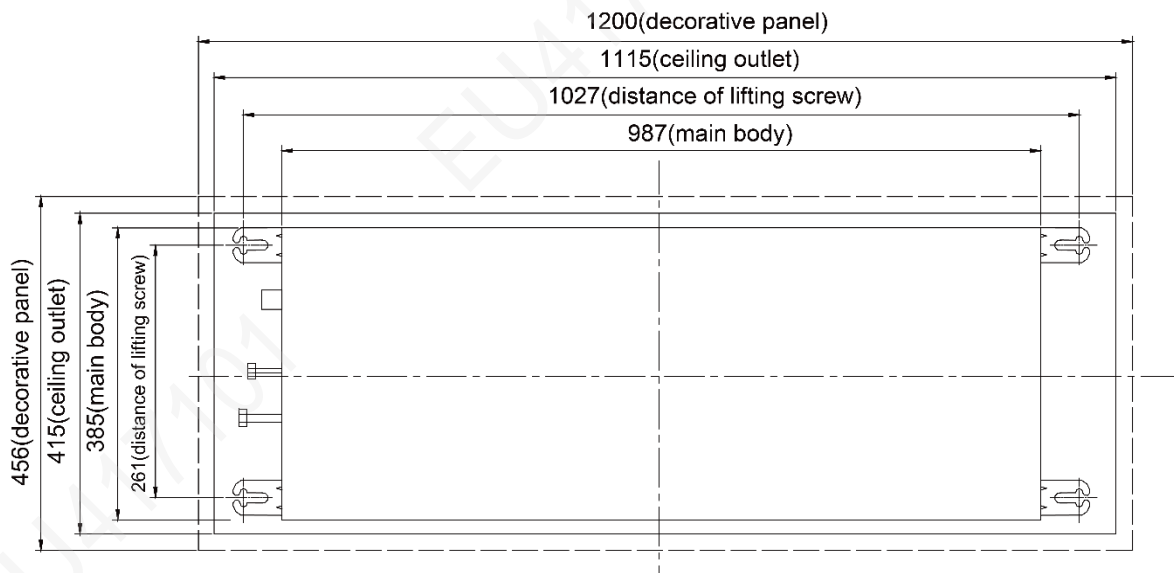

GMV-ND63~80TD/B-T:

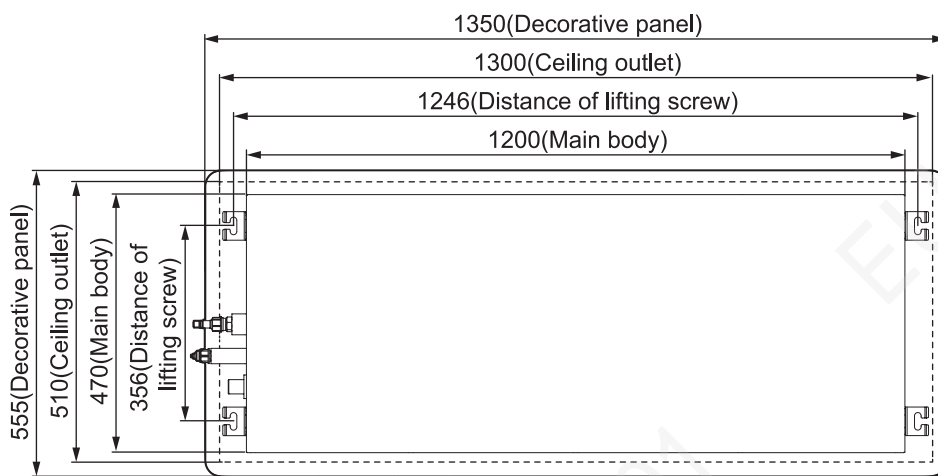

## 7.2.4 Fresh Air Processing Unit

External Dimensions  
GMV-NX450P/A (X4.0)-M

Unit: mm

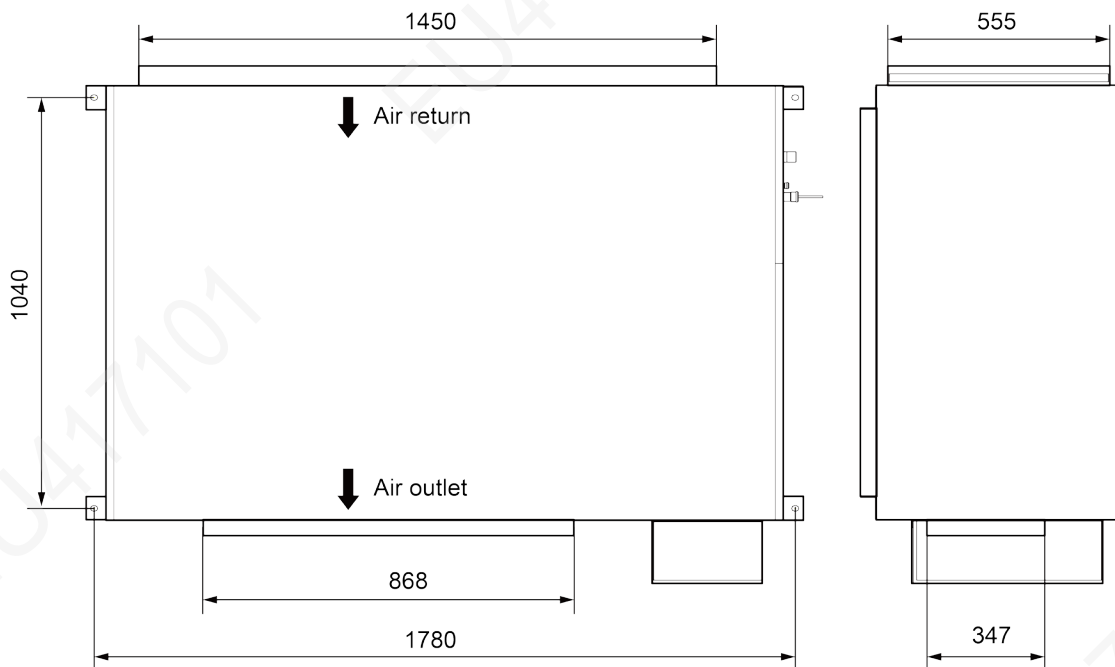

GMV-NDX125P/A-T, GMV-NDX140P/A-T

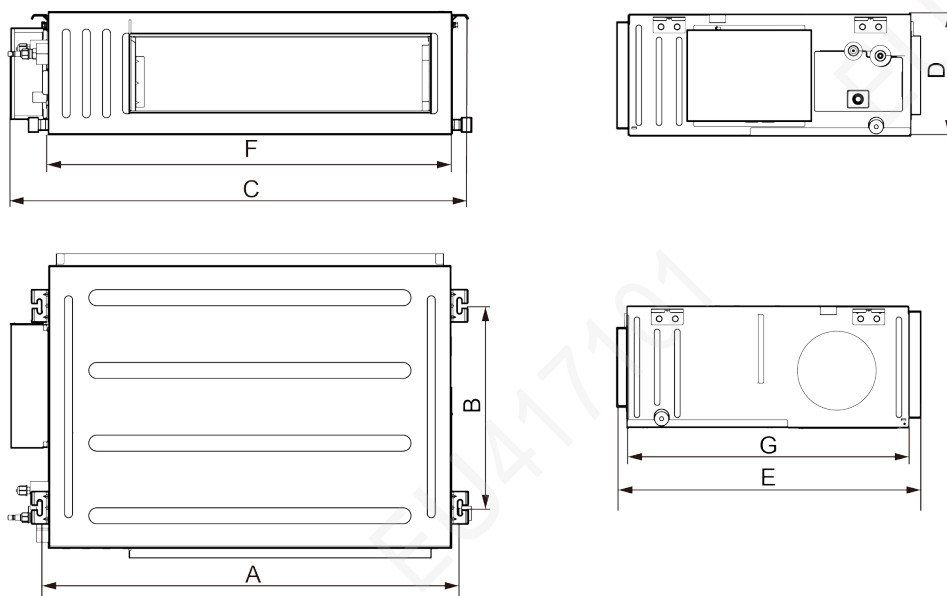

The table below lists the detailed dimensions.

Unit: mm

Model	A	B	C	D	E	F	G
GMV-NDX125P/A-T	1440	500	1530	300	754	1400	700
GMV-NDX140P/A-T	1440	500	1530	300	754	1400	700

GMV-NDX224P/A-T, GMV-NDX250P/A-T, GMV-NDX280P/A-T

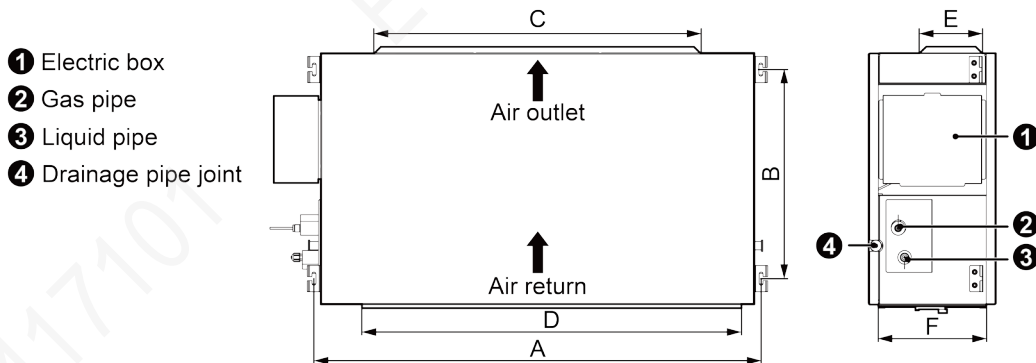

The table below lists the detailed dimensions.

Unit: mm

Model	A	B	C	D	E	F
GMV-NDX224P/A-T	1353	632	992	1150	192	327
GMV-NDX250P/A-T	1353	632	992	1150	192	327
GMV-NDX280P/A-T	1353	632	992	1150	192	327

Installation and Maintenance Spaces

Unit: mm

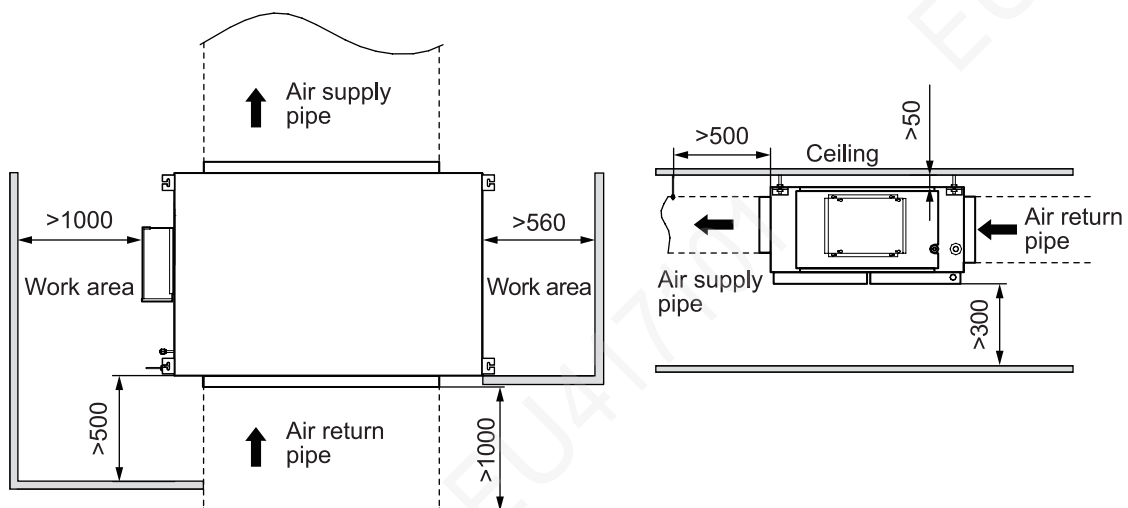

Shape and Size of Air-outlet and Air-return Opening  
GMV-NX450P/A (X4.0)-M

Unit: mm

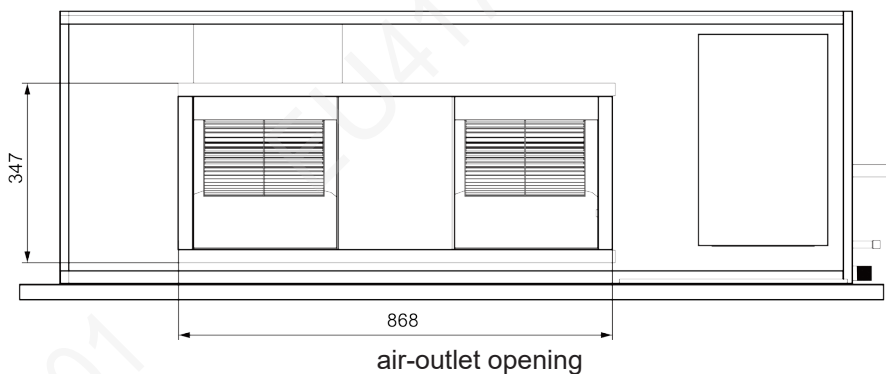

Unit: mm

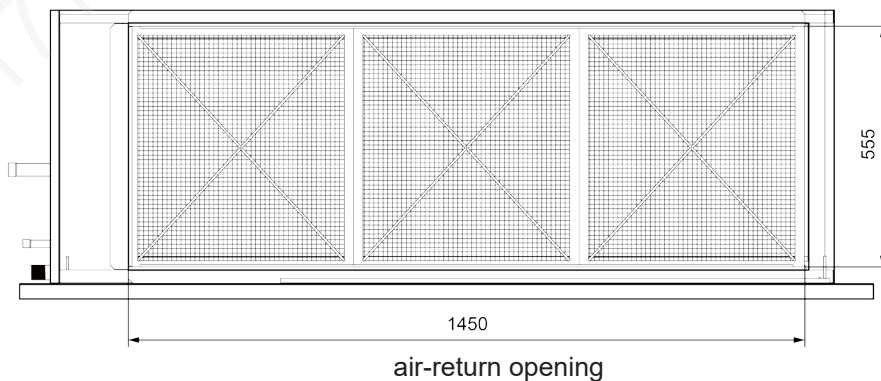

GMV-NDX125P/A-T, GMV-NDX140P/A-T, GMV-NDX224P/A-T, GMV-NDX250P/A-T, GMV-NDX280P/A-T

Unit: mm

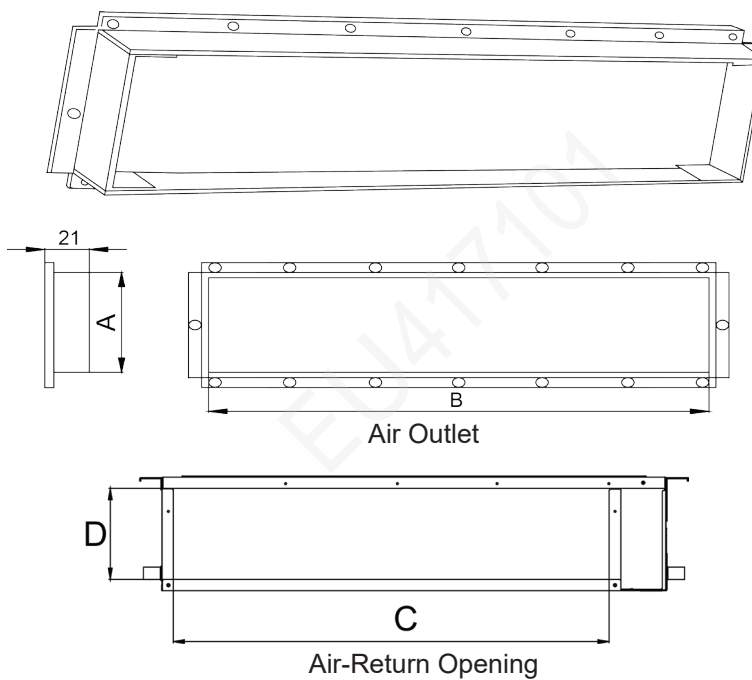

Unit: mm

Model	Dimension of Air Outlet		Dimension of Air -return Opening	
	A	B	C	D
GMV-NDX125P/A-T	197	1151	1362	264
GMV-NDX140P/A-T	197	1151	1362	264
GMV-NDX224P/A-T	192	992	1150	327
GMV-NDX250P/A-T	192	992	1150	327
GMV-NDX280P/A-T	192	992	1150	327

### 7.2.5 Floor Ceiling Type

#### (1) Outline Dimensions

The table below lists the detailed dimensions.

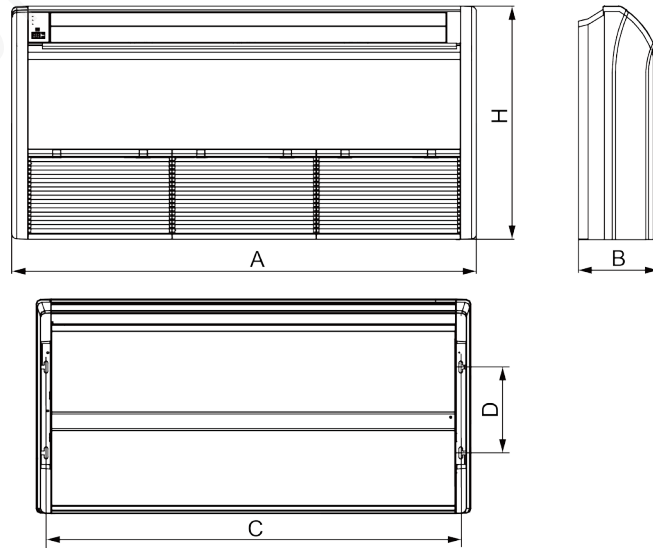

Unit: mm

Model	A	B	C	D	H
GMV-ND28ZD/A-T GMV-ND36ZD/A-T GMV-ND50ZD/A-T GMV-ND56ZD/A-T	1220	225	1158	280	700
GMV-ND63ZD/A-T GMV-ND71ZD/A-T GMV-ND90ZD/A-T	1420	245	1354	280	700
GMV-ND112ZD/A-T GMV-ND125ZD/A-T GMV-ND140ZD/A-T GMV-ND160ZD/A-T	1700	245	1634	280	700

# DC INVERTER MULTI VRF INDOOR UNIT TECHNICAL SALES GUIDE

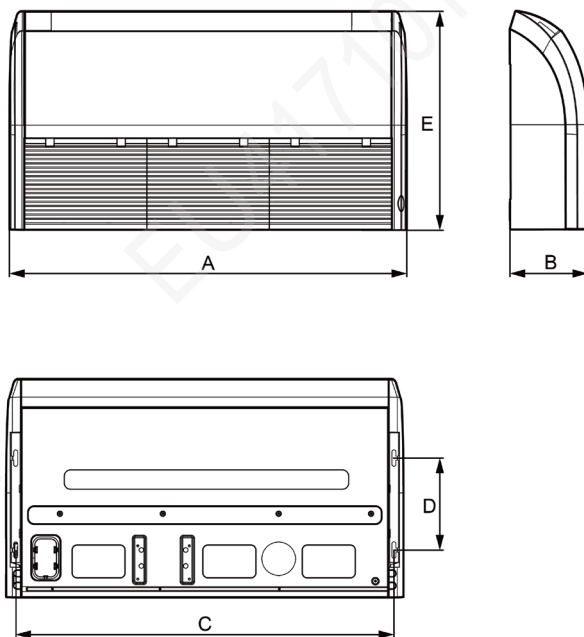

Unit: mm

Model	A	B	C	D	E
GMV-ND28ZD/B-T	870	235	812	280	665
GMV-ND36ZD/B-T					
GMV-ND50ZD/B-T					
GMV-ND56ZD/B-T	1200	235	1142	280	665
GMV-ND63ZD/B-T					
GMV-ND71ZD/B-T					
GMV-ND90ZD/B-T	1570	235	1512	280	665
GMV-ND112ZD/B-T					
GMV-ND125ZD/B-T					
GMV-ND140ZD/B-T					
GMV-ND160ZD/B-T					

## (2) Installation and Maintenance Spaces

GMV-ND\*\*ZD/A-T:

Floor type

Unit: mm

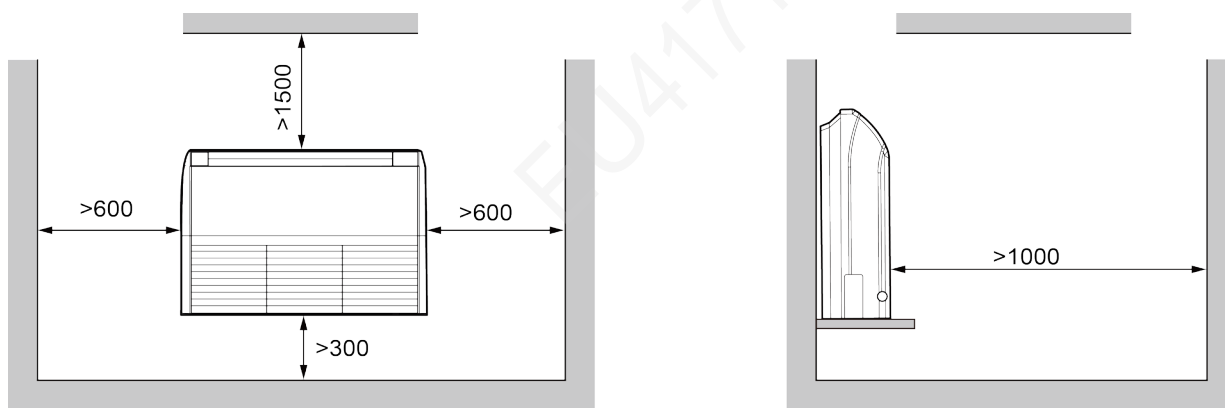

Ceiling type

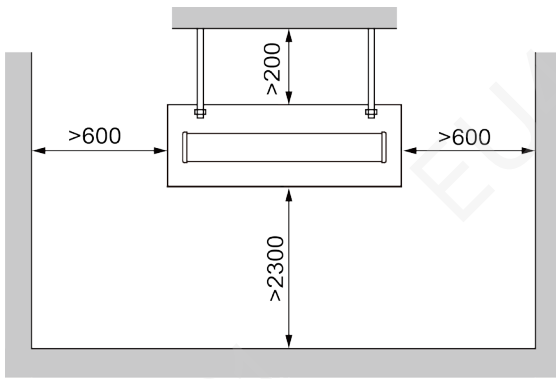

Unit: mm

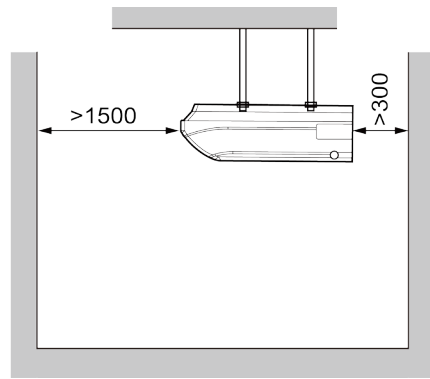

GMV-ND\*\*ZD/B-T:  
Floor type

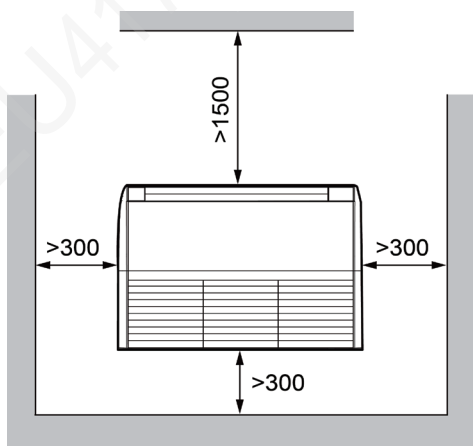

Unit: mm

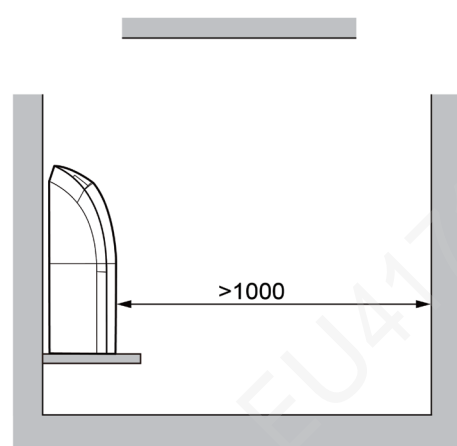

Ceiling type

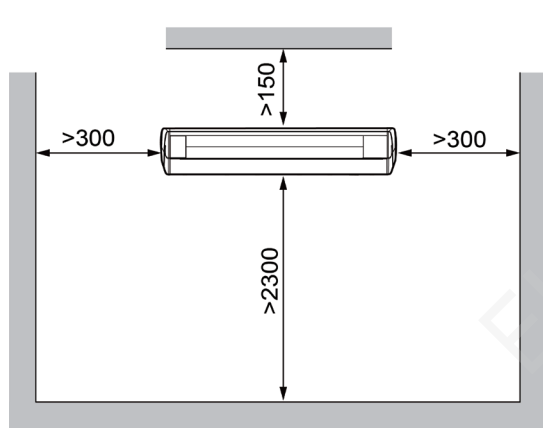

Unit: mm

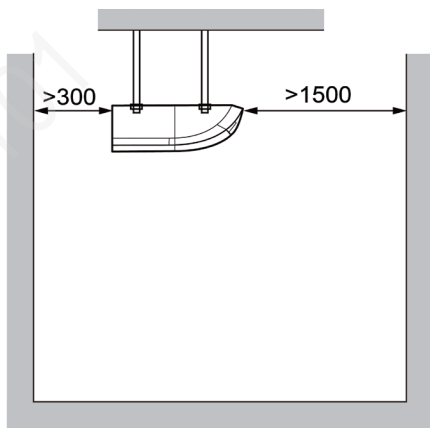

## 7.2.6 Wall-Mounted Type

### Outline Dimensions

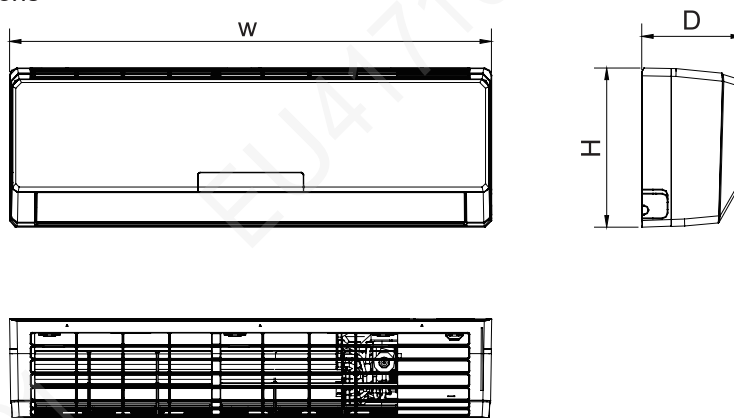

The table below lists the detailed dimensions.

Unit: mm

Model	W	H	D
GMV-N22G/A3A-K, GMV-N22G/A2A-K, GMV-N22G/A4A-K GMV-N22G/A8A-K, GMV-N22G/C9A-K, GMV-N22G/E3A-K GMV-N28G/A3A-K, GMV-N28G/A2A-K, GMV-N28G/A4A-K GMV-N28G/A8A-K, GMV-N28G/C9A-K, GMV-N28G/E3A-K GMV-N22G/B3A-K, GMV-N28G/B3A-K GMV-N22G/A3A-D, GMV-N28G/A3A-D, GMV-N22G/A2A-D GMV-N28G/A2A-D, GMV-N22G/A4A-D, GMV-N28G/A4A-D GMV-N22G/A8A-D, GMV-N28G/A8A-D, GMV-N22G/C9A-D GMV-N28G/C9A-D, GMV-N22G/E3A-D, GMV-N28G/E3A-D GMV-N22G/B3A-D, GMV-N28G/B3A-D GMV-ND22G/A3A-T, GMV-ND28G/A3A-T GMV-ND22G/A8A-T, GMV-ND28G/A8A-T	843	275	180
GMV-N36G/A3A-K, GMV-N36G/A2A-K, GMV-N36G/A4A-K GMV-N36G/A8A-K, GMV-N36G/C9A-K, GMV-N36G/E3A-K GMV-N45G/A3A-K, GMV-N45G/A2A-K, GMV-N45G/A4A-K GMV-N45G/A8A-K, GMV-N45G/C9A-K, GMV-N45G/E3A-K GMV-N50G/A3A-K, GMV-N50G/A2A-K, GMV-N50G/A4A-K GMV-N50G/A8A-K, GMV-N50G/C9A-K, GMV-N50G/E3A-K GMV-N36G/B3A-K, GMV-N45G/B3A-K, GMV-N50G/B3A-K GMV-N36G/A3A-D, GMV-N45G/A3A-D, GMV-N50G/A3A-D GMV-N36G/A2A-D, GMV-N45G/A2A-D, GMV-N50G/A2A-D GMV-N36G/A4A-D, GMV-N45G/A4A-D, GMV-N50G/A4A-D GMV-N36G/A8A-D, GMV-N45G/A8A-D, GMV-N50G/A8A-D GMV-N36G/C9A-D, GMV-N45G/C9A-D, GMV-N50G/C9A-D GMV-N36G/E3A-D, GMV-N45G/E3A-D, GMV-N50G/E3A-D GMV-N36G/B3A-D, GMV-N45G/B3A-D, GMV-N50G/B3A-D GMV-ND36G/A3A-T, GMV-ND45G/A3A-T, GMV-ND50G/A3A-T GMV-ND36G/A8A-T, GMV-ND45G/A8A-T, GMV-ND50G/A8A-T	940	298	200



Model	W	H	D
GMV-N56G/A3A-K, GMV-N56G/A2A-K, GMV-N56G/A4A-K GMV-N56G/A8A-K, GMV-N56G/C9A-K, GMV-N56G/E3A-K GMV-N56G/B3A-K GMV-N63G/A3A-K, GMV-N63G/A2A-K, GMV-N63G/A4A-K GMV-N63G/A8A-K, GMV-N63G/C9A-K, GMV-N63G/E3A-K GMV-N63G/B3A-K GMV-N71G/A3A-K, GMV-N71G/A2A-K, GMV-N71G/A4A-K GMV-N71G/A8A-K, GMV-N71G/C9A-K, GMV-N71G/E3A-K GMV-N71G/B3A-K GMV-N56G/A3A-D, GMV-N63G/A3A-D, GMV-N71G/A3A-D GMV-N56G/A2A-D, GMV-N63G/A2A-D, GMV-N71G/A2A-D GMV-N56G/A4A-D, GMV-N63G/A4A-D, GMV-N71G/A4A-D GMV-N56G/A8A-D, GMV-N63G/A8A-D, GMV-N71G/A8A-D GMV-N56G/C9A-D, GMV-N63G/C9A-D, GMV-N71G/C9A-D GMV-N56G/E3A-D, GMV-N63G/E3A-D, GMV-N71G/E3A-D GMV-N56G/B3A-D, GMV-N63G/B3A-D, GMV-N71G/B3A-D GMV-ND56G/A3A-T, GMV-ND63G/A3A-T, GMV-ND71G/A3A-T GMV-ND56G/A8A-T, GMV-ND63G/A8A-T, GMV-ND71G/A8A-T	1008	319	221
GMV-ND80G/A3A-T, GMV-ND90G/A3A-T, GMV-ND100G/A3A-T GMV-ND80G/A8A-T, GMV-ND90G/A8A-T, GMV-ND100G/A8A-T	1350	326	258
GMV-ND15G/B4B-T, GMV-ND18G/B4B-T, GMV-ND22G/B4B-T, GMV-ND28G/B4B-T, GMV-ND15G/B6B-T, GMV-ND18G/B6B-T, GMV-ND22G/B6B-T, GMV-ND28G/B6B-T, GMV-ND22G/C4B-T, GMV-ND28G/C4B-T, GMV-ND22G/D2B-T, GMV-ND28G/D2B-T, GMV-ND22G/C2B-T, GMV-ND28G/C2B-T	845	289	209
GMV-ND36G/B4B-T, GMV-ND45G/B4B-T, GMV-ND50G/B4B-T, GMV- ND36G/B6B-T, GMV-ND45G/B6B-T, GMV-ND50G/B6B-T GMV-ND36G/C4B-T, GMV-ND45G/C4B-T, GMV-ND50G/C4B-T GMV-ND36G/C2B-T, GMV-ND45G/C2B-T, GMV-ND50G/C2B-T GMV-ND36G/D2B-T, GMV-ND45G/D2B-T, GMV-ND50G/D2B-T	970	300	224
GMV-ND56G/B4B-T, GMV-ND63G/B4B-T, GMV-ND71G/B4B- T, GMV-ND56G/B6B-T, GMV-ND63G/B6B-T, GMV-ND71G/B6B-T GMV-ND56G/C4B-T, GMV-ND63G/C4B-T, GMV-ND71G/C4B-T GMV-ND56G/C2B-T, GMV-ND63G/C2B-T, GMV-ND71G/C2B-T GMV-ND56G/D2B-T, GMV-ND63G/D2B-T, GMV-ND71G/D2B-T	1078	325	246
GMV-ND80G/B4B-T, GMV-ND90G/B4B-T, GMV-ND100G/B4B-T	1350	326	258

Installation and Maintenance Spaces(Unit: mm)

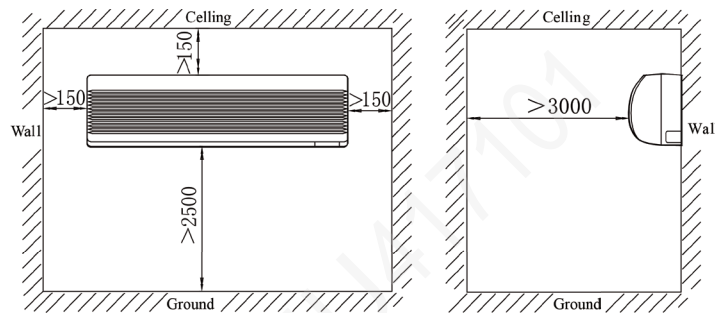

## 7.2.7 Console Type

Exposed		Half concealed	Concealed
Floor Installation	Wall Installation		

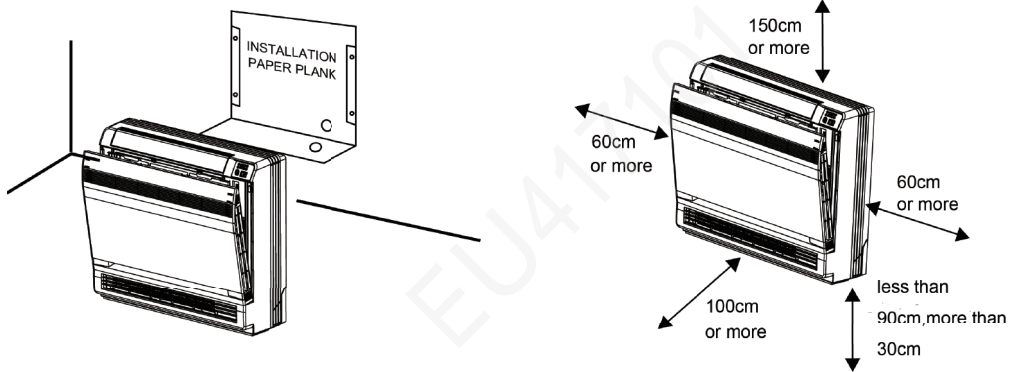
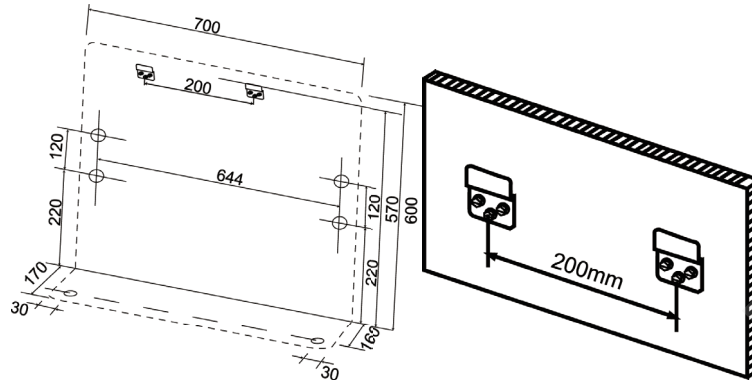

### 7.2.8 Floor Standing Type

#### Outline Dimensions

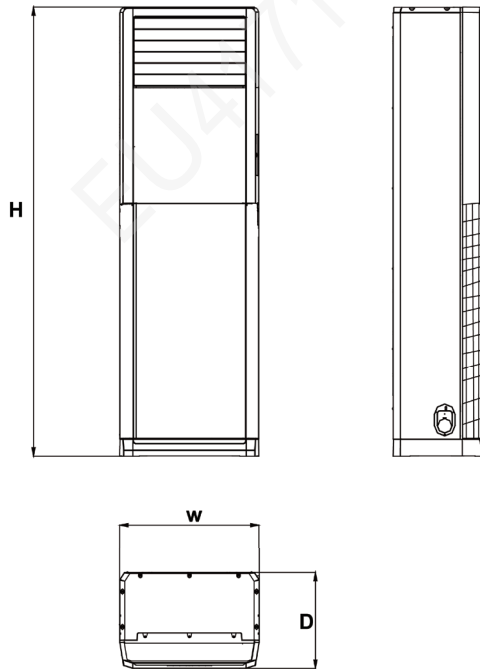

The table below lists the detailed dimensions.

Unit: mm

Model	H	W	D
GMV-ND100L/A-T GMV-ND140L/A-T	1870	580	400

#### Installation and Maintenance Spaces(Unit:mm)

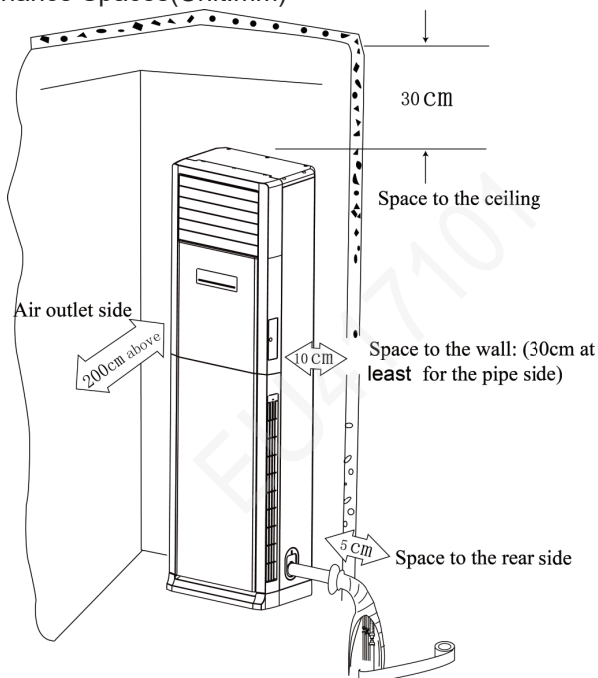

## 7.2.9 Compact Four-way Cassette Type

Requirements for outline dimensions and installation and maintenance spaces

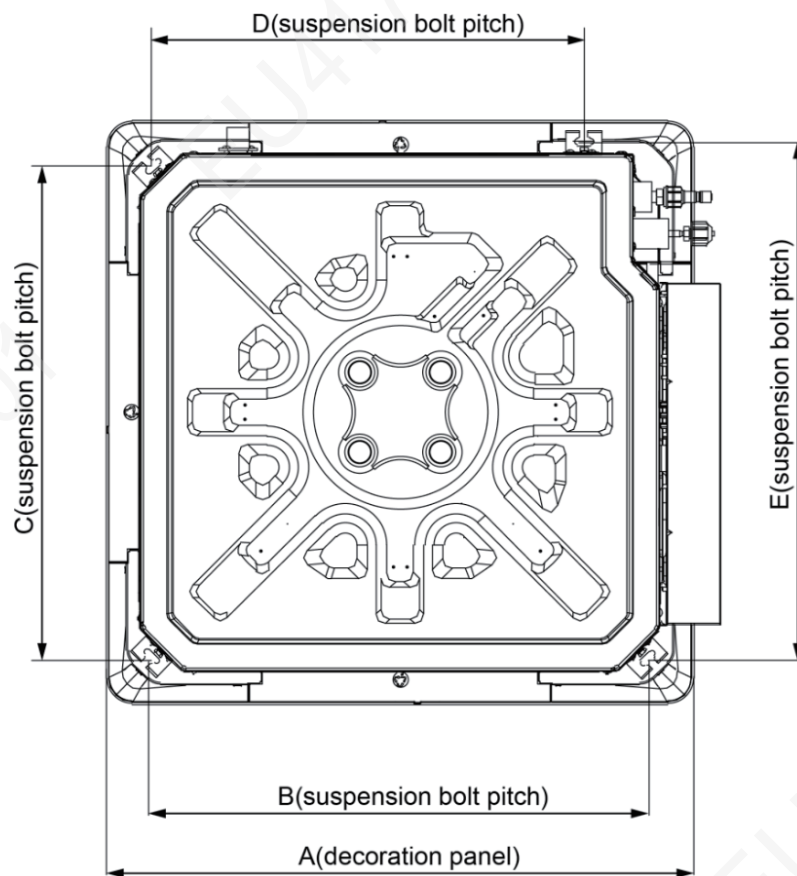

Below are dimensions of A, B, C, etc. for different models:

Unit: mm

Model	A	B	C	D	E
GMV-ND22T/B-T	670	570	570	495	600
GMV-ND28T/B-T					
GMV-ND36T/B-T					
GMV-ND45T/B-T					
GMV-ND50T/B-T					
GMV-ND56T/B-T					

Unit: mm

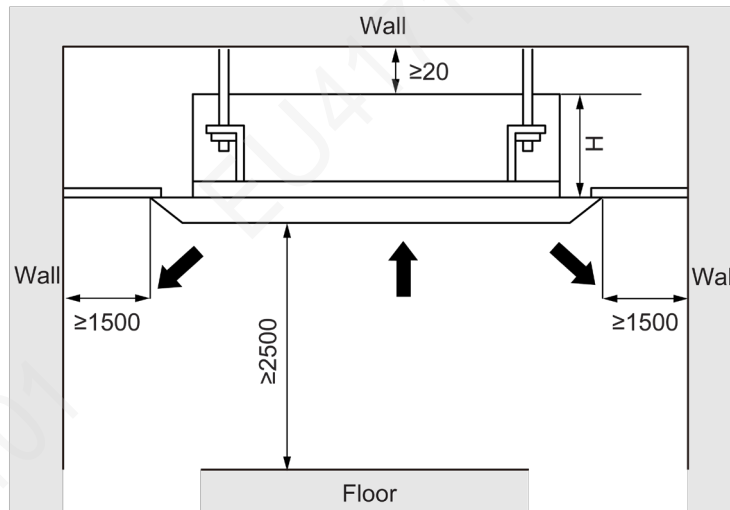

Model	H
GMV-ND22T/B-T	255
GMV-ND28T/B-T	
GMV-ND36T/B-T	
GMV-ND45T/B-T	
GMV-ND50T/B-T	
GMV-ND56T/B-T	

### 7.2.10 360° Air Discharge Compact Cassette Type

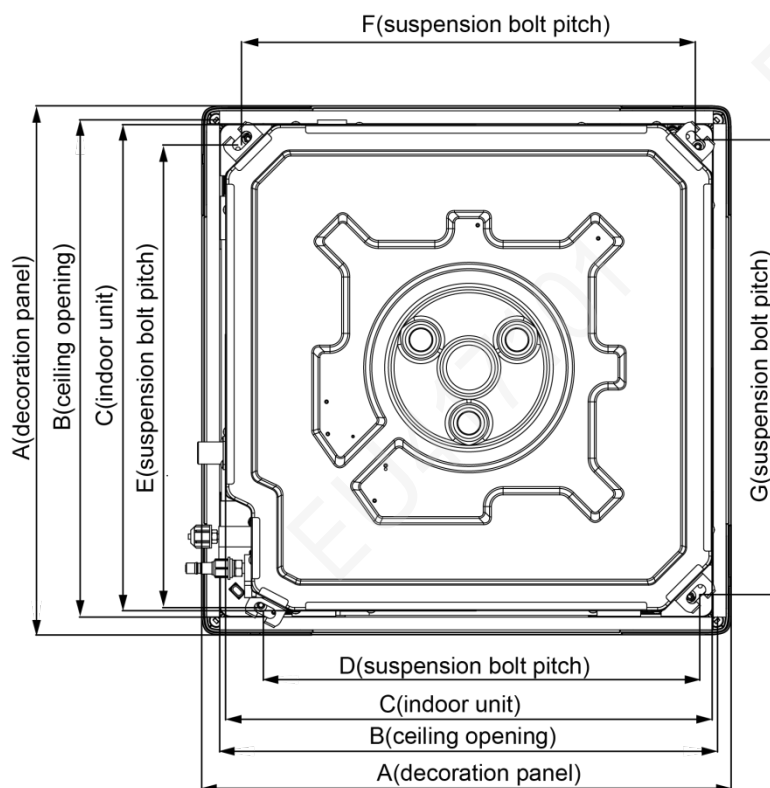

# DC INVERTER MULTI VRF INDOOR UNIT TECHNICAL SALES GUIDE

Unit: mm

Model	A	B	C	D	E	F	G
GMV-ND15T/E-T	620	580	570	505	550	530	530
GMV-ND18T/E-T							
GMV-ND22T/E-T							
GMV-ND28T/E-T							
GMV-ND36T/E-T							
GMV-ND45T/E-T							
GMV-ND50T/E-T							
GMV-ND56T/E-T							

Unit: mm

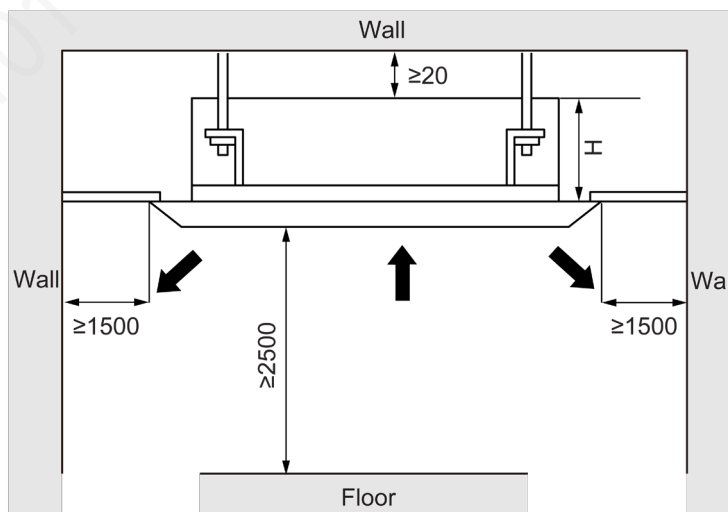

Model	H
GMV-ND15T/E-T	305
GMV-ND18T/E-T	
GMV-ND22T/E-T	
GMV-ND28T/E-T	
GMV-ND36T/E-T	
GMV-ND45T/E-T	
GMV-ND50T/E-T	
GMV-ND56T/E-T	

### 7.2.11 AHU-KIT Type

(1) Dimension of control box for GMV-N36U/C-T, GMV-N71U/C-T, GMV-N140U/C-T, GMV-N280U/C-T and GMV-N560U/C-T (Unit: mm):

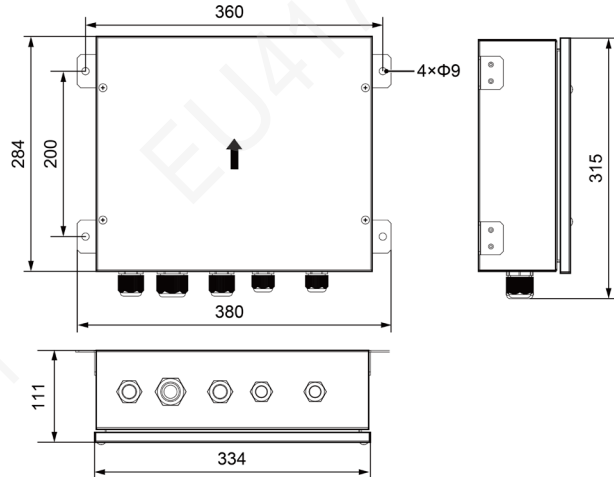

(2) Dimension of EXV box for GMV-N36U/C-T (Unit: mm):

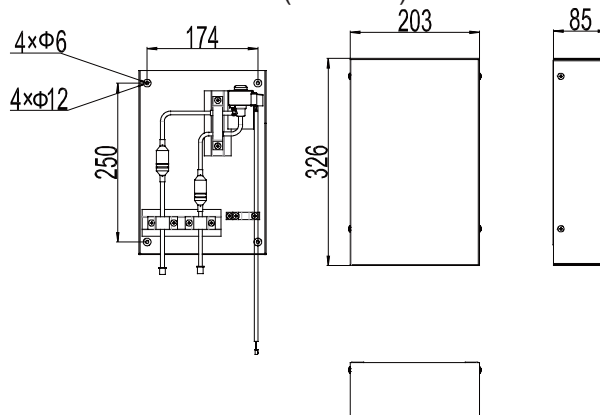

(3) Dimension of EXV box for GMV-N71U/C-T, GMV-N140U/C-T and GMV-N280U/C-T (Unit: mm):

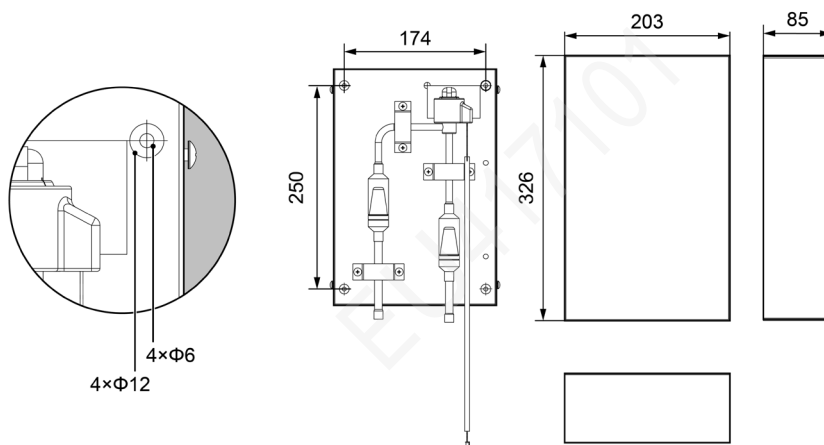

(4) Dimension of EXV box for GMV-N560U/A-T (Unit: mm):

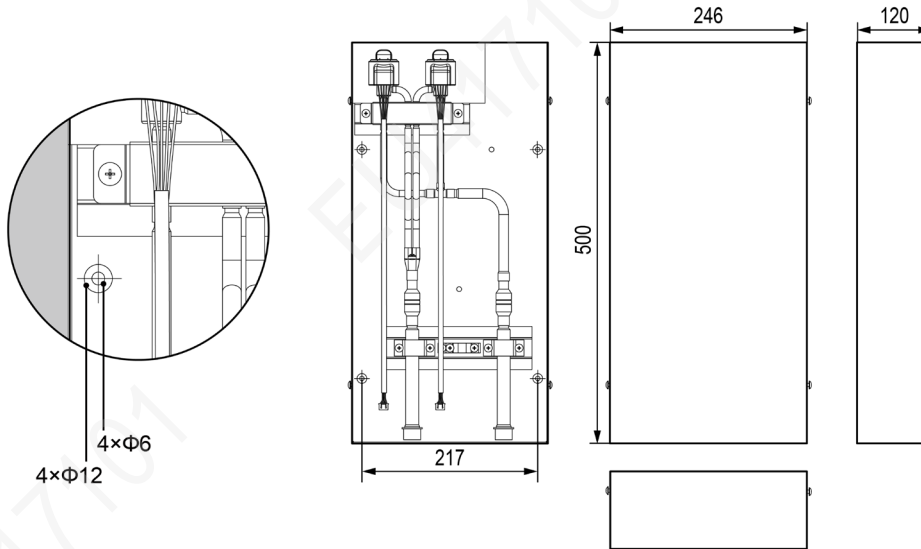

(5) Maintenance space of control space (Unit: mm):

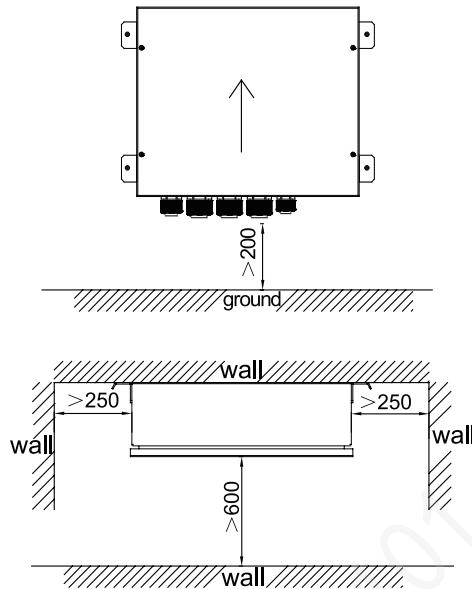

The control box must be installed upwards as the direction of the arrow shown in the figure



(6) Maintenance space of EXV box (Unit: mm):

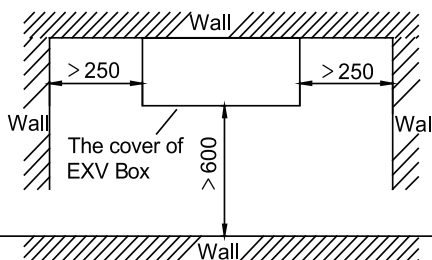
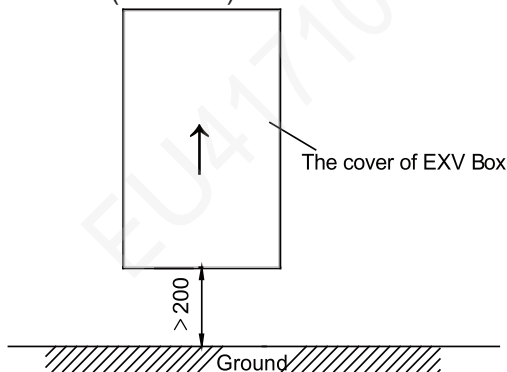

The EXV box must be installed upwards as the direction of the arrow shown in the figure

### 7.2.12 Two-way Cassette Type

Requirements for outline dimensions and installation and maintenance spaces

#### 7.2.12.1 GMV-ND\*\*TS/A-T

Outline Dimensions

Unit: mm

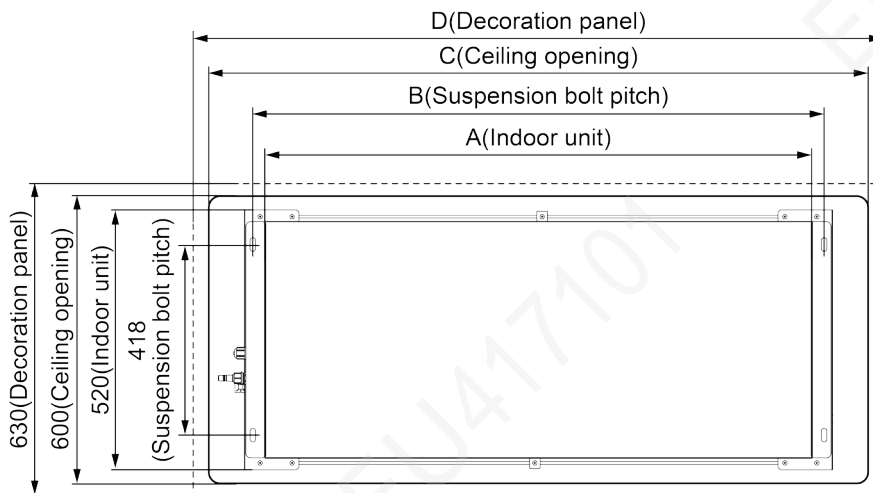

Model	Indoor unit(A)	Suspension bolt pitch(B)	Ceiling opening(C)	Decoration panel(D)	Outer diameter of connection pipe(mm)	
					Liquid pipe	Gas pipe
GMV-ND28TS/A-T	1200	1252	1386	1416	6.35	9.52
GMV-ND36TS/A-T GMV-ND45TS/A-T GMV-ND50TS/A-T	1200	1252	1386	1416	6.35	12.7

# DC INVERTER MULTI VRF INDOOR UNIT TECHNICAL SALES GUIDE

Model	Indoor unit(A)	Suspension bolt pitch(B)	Ceiling opening(C)	Decoration panel(D)	Outer diameter of connection pipe(mm)	
					Liquid pipe	Gas pipe
GMV-ND56TS/A-T GMV-ND63TS/A-T GMV-ND71TS/A-T	1200	1252	1386	1416	9.52	15.9

Installation and Maintenance Spaces

Unit: mm

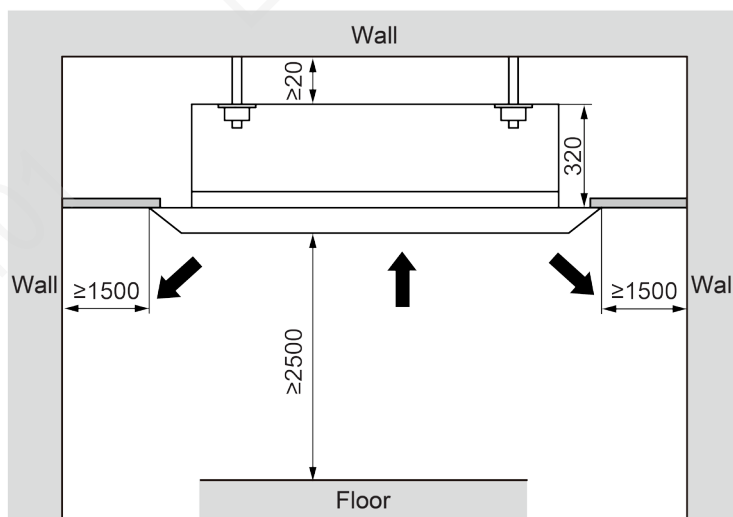

## 7.2.12.2 GMV-ND\*\*TS/B-T

Ceiling Opening Dimension and Suspension Bolt Position

Unit: mm

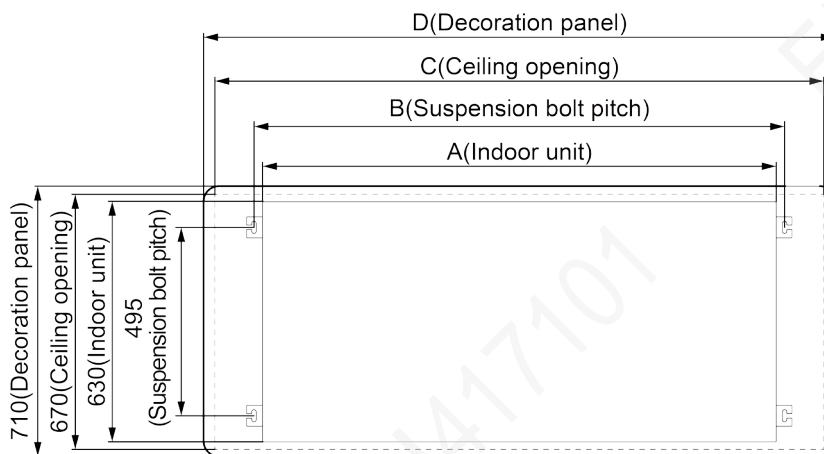

Unit: mm

Model	Indoor unit(A)	Suspension bolt pitch(B)	Ceiling opening(C)	Decoration panel(D)
GMV-ND28~80TS/B-T	790	834	990	1100
GMV-ND90~160TS/B-T	1350	1394	1550	1660

Installation Position Selection

Unit: mm

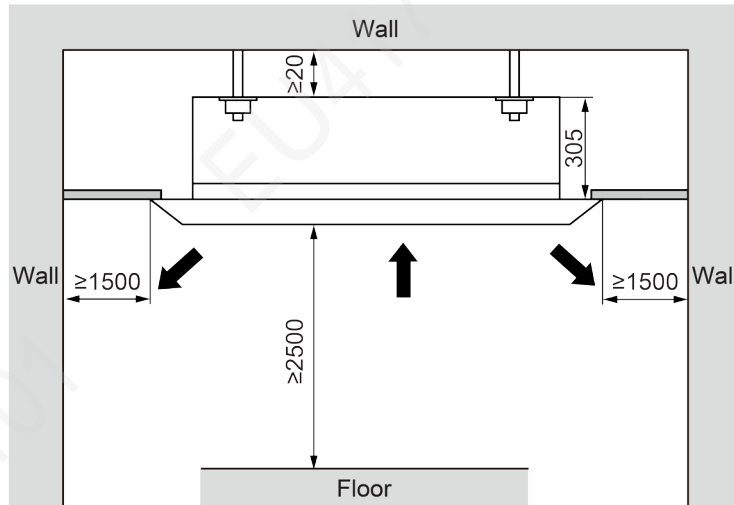

Three-view drawing of main body  
GMV-ND28~80TS/B-T

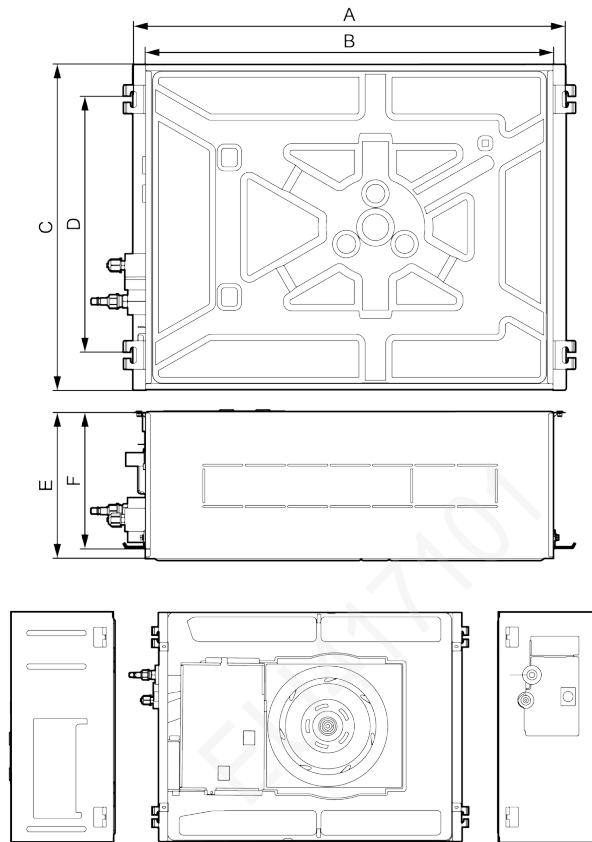

GMV-ND90~160TS/B-T

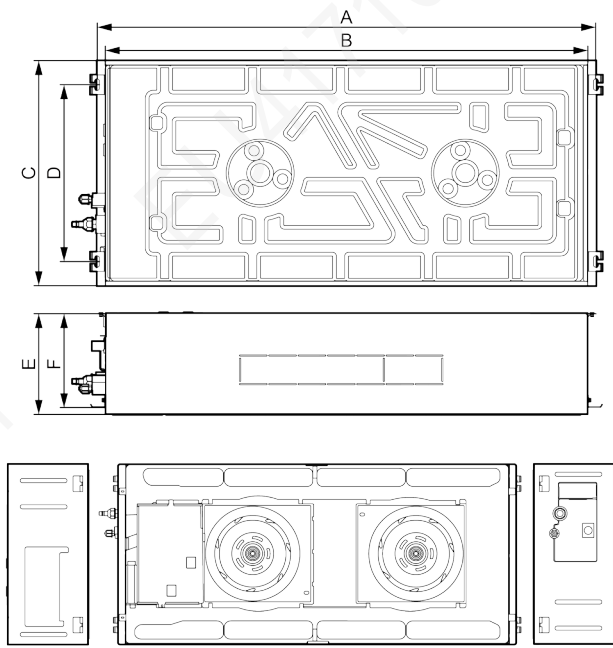

Unit: mm

Model	A	B	C	D	E	F
GMV-ND28~80TS/B-T	834	790	630	495	280	261
GMV-ND90~160TS/B-T	1394	1350	630	495	280	261

Three-view drawing of panel  
TE03

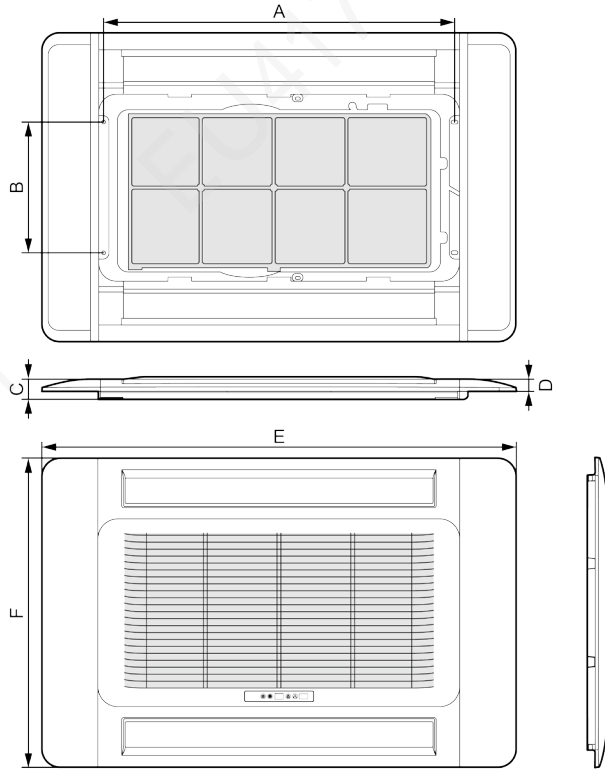

TE04

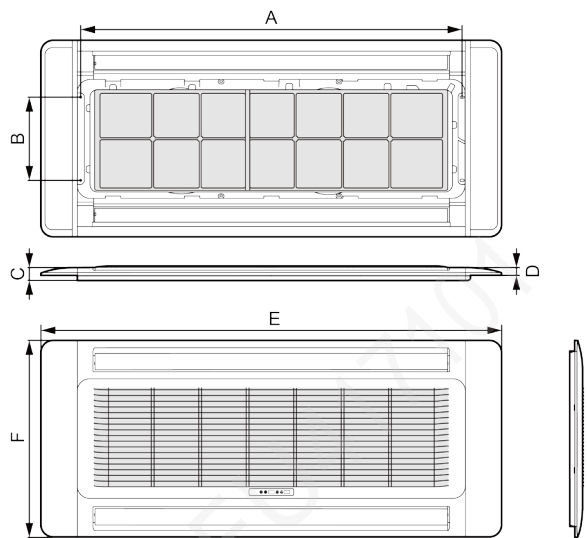

Unit: mm

Model	A	B	C	D	E	F
TE03	813	300	46	28	1100	710
TE04	1374	300	46	28	1660	710

## 7.2.13 Air Handler type Indoor Unit

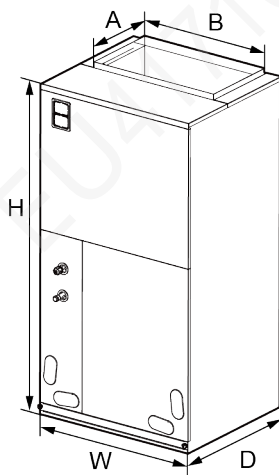

Unit: mm

Model	DIMENSION				
	W	D	H	A	B
GMV-NR71A/A-D	460	540	1105	295	426
GMV-NR90A/A-D	460	540	1105	295	426
GMV-NR100A/A-D	540	540	1224	295	508
GMV-NR112A/A-D	540	540	1224	295	508
GMV-NR140A/A-D	630	540	1224	295	508

When installing the air handler, take consideration to minimize the length of refrigerant tubing as much as possible. Do not install the air handler in a location either above or below the condenser that violates the instructions provided with the condenser. Service clearance is to take precedence. Allow a minimum of 24" in front of the unit for service clearance. When installing in an area directly over a finished ceiling (such as an attic), an emergency drain pan is required directly under the unit. See local and state codes for requirements. When installing this unit in an area that may become wet, elevate the unit with a sturdy, non-porous material. In installations that may lead to physical damage (i.e. a garage) it is advised to install a protective barrier to prevent such damage.

This air handler is designed for a complete supply and return ductwork system. Do not operate this product without all ductwork attached.

Based upon the actual conditions, if air handler is installed as type (A), the air handler should be concealed in a specific room or space and make sure the air handler is not accessible to the general public.

Based upon the actual conditions, if air handler is installed as type (B), make sure that there is enough space for care and maintenance and the height between the air handler and ground is above 2500mm. And the air handler is not accessible to the general public.

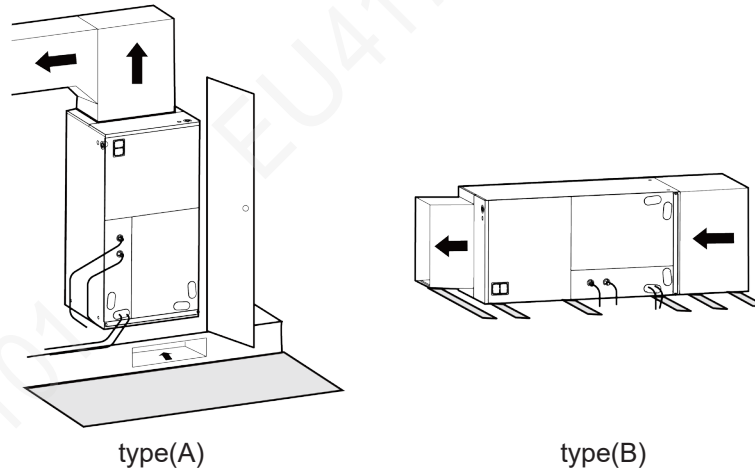

### 7.2.14 Slim Duct Type

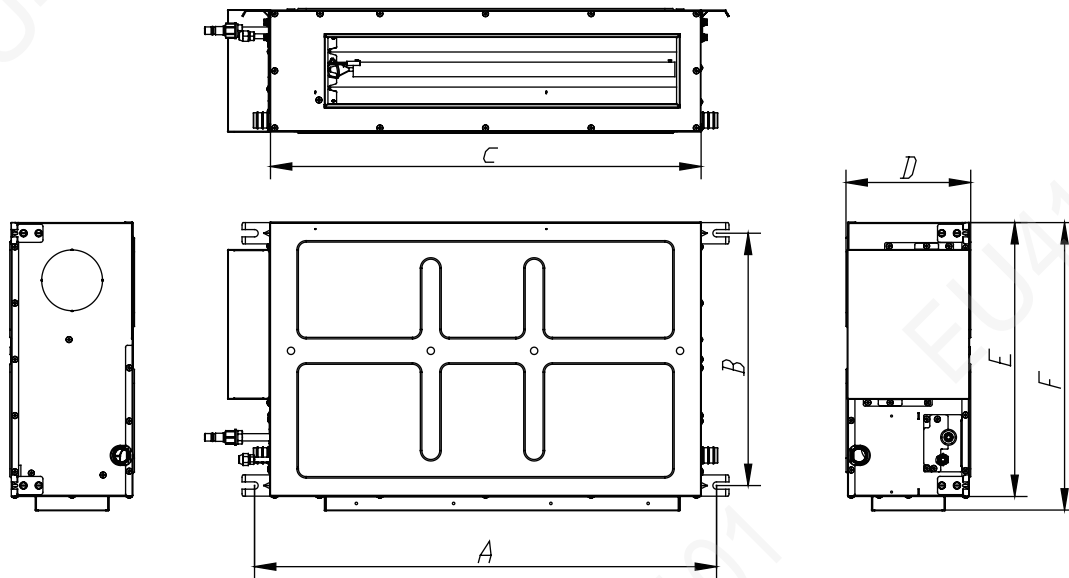

Unit: mm

Model	A	B	C	D	E	F
GMV-ND22~36PL/B-T GMV-ND22~36PLS/B1-T	760	415	710	200	450	475
GMV-ND40~63PL/B-T GMV-ND40~63PLS/B1-T	1060	415	1010	200	450	475
GMV-ND72PL/B-T GMV-ND71PLS/B1-T	1360	415	1310	200	450	475

Installation space

Unit:mm

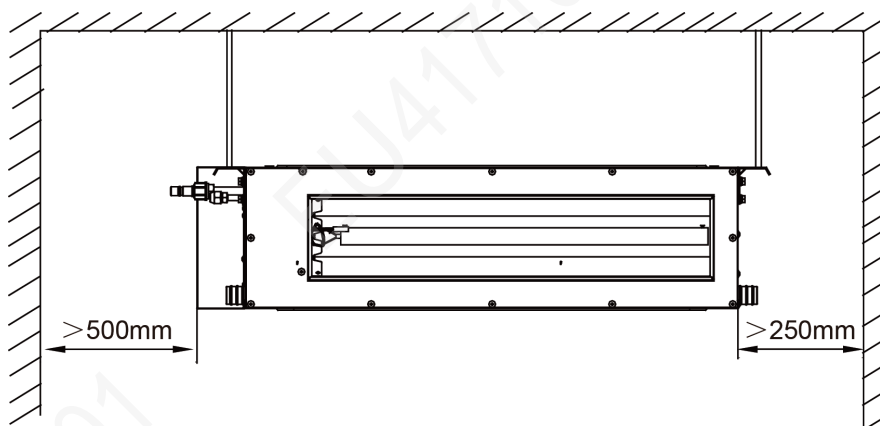

## 7.2.15 Concealed Floor Standing Type

(1) Outline and installation dimension

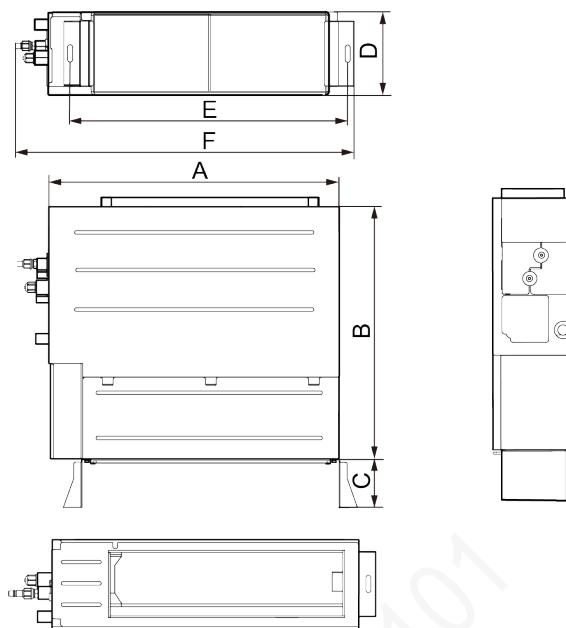

Below are dimensions of A, B, C, etc. for different models:

Unit: mm

Model	A	B	C	D	E	F
GMV-ND22~36ZA/A-T	700	615	120	200	665.5	837
GMV-ND45ZA/A-T	900	615	120	200	865.5	1045
GMV-ND56~71ZA/A-T	1100	615	120	200	1065.5	1236



(2) Installation space

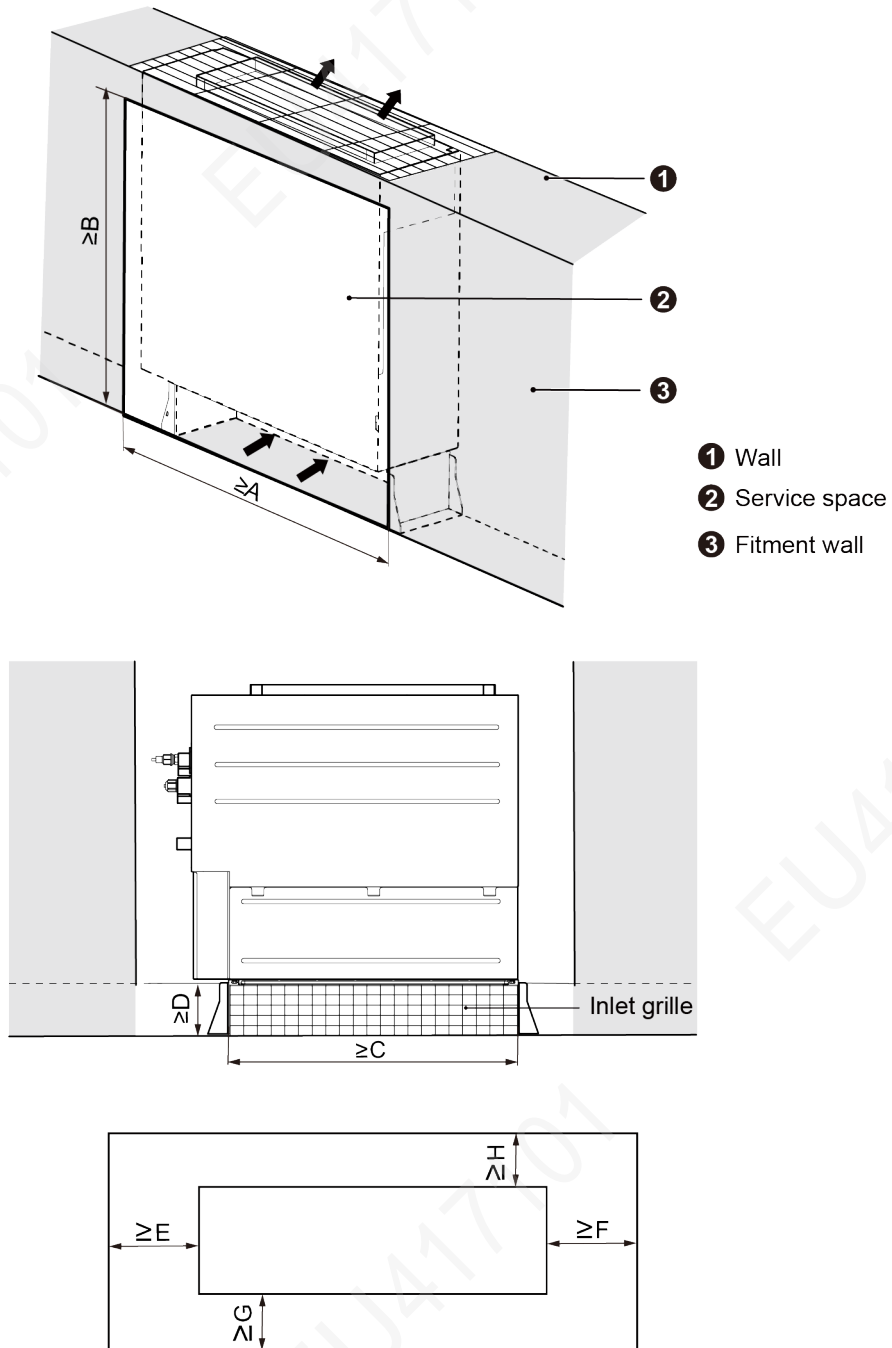

Below are dimensions of A, B, C, etc. for different models:

Unit: mm

Model	A	B	C	D	E	F	G	H
GMV-ND22~36ZA/A-T	1200	665	615	120	200	200	20	20
GMV-ND45ZA/A-T	1400	665	815	120	200	200	20	20
GMV-ND56~71ZA/A-T	1600	665	1015	120	200	200	20	20

## 7.2.16 360° Air Discharge Cassette Type

### 7.2.16.1 GMV-ND\*\*T/C-T

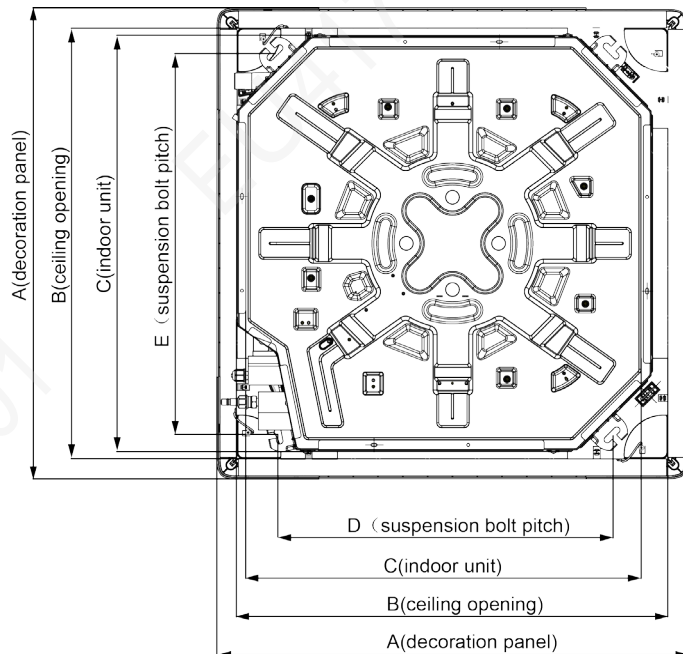

Unit: mm

Model	A	B	C	D	E
GMV-ND22~160T/C-T	950	890	840	680	780

Unit: mm

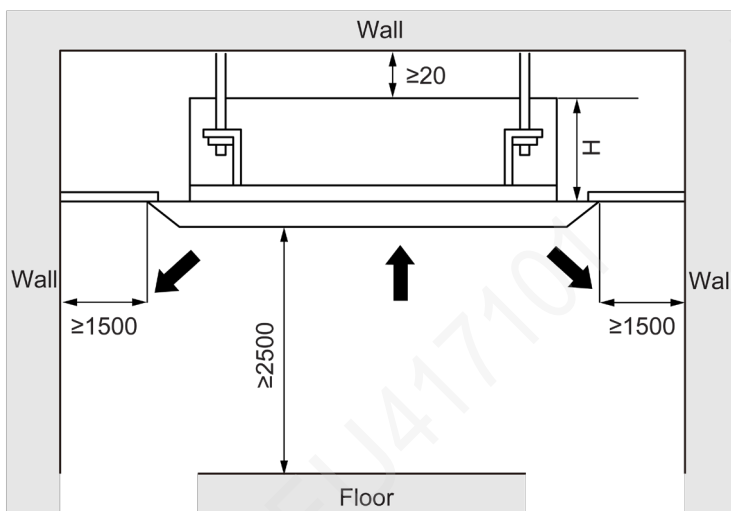

Unit: mm

Model	H(mm)
GMV-ND22~100T/C-T	275
GMV-ND112~160T/C-T	325

### 7.2.16.2 GMV-ND\*\*T/C1-T

Ceiling Opening Dimension and Suspension Bolt Position.

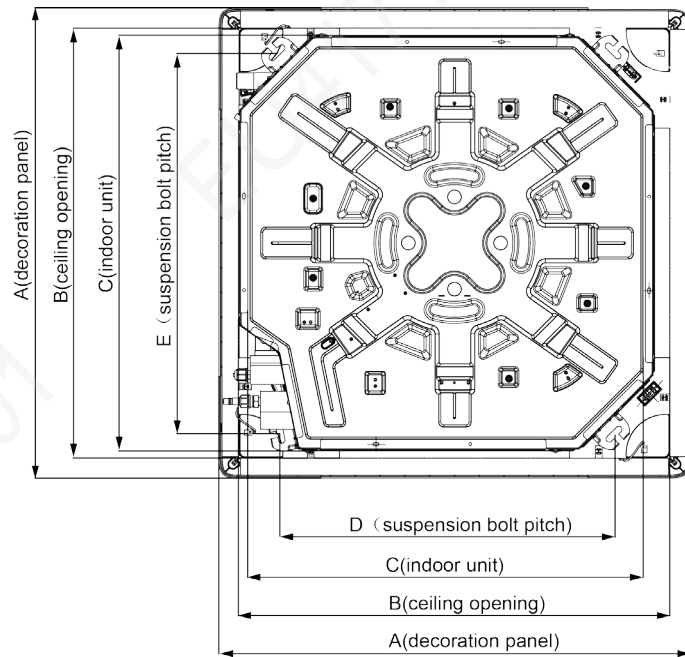

Unit: mm

Model	A	B	C	D	E
GMV-ND22~50T/C1-T	950	890	840	680	780

Unit: mm

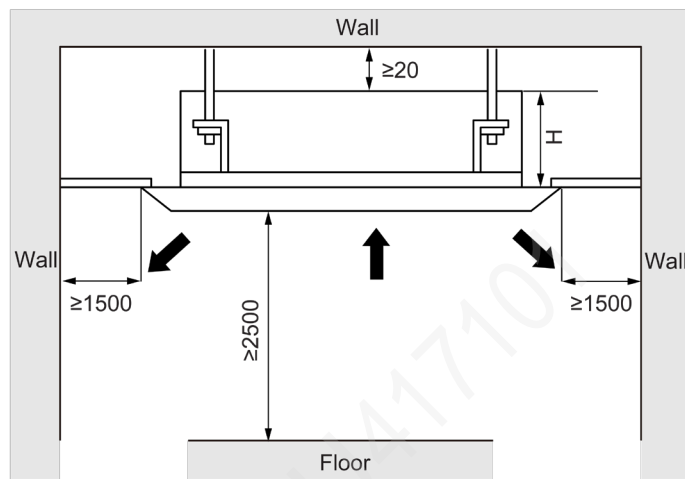

Model	H(mm)
GMV-ND22~50T/C1-T	235

## 7.2.16.3 GMV-ND\*\*T/D1-T

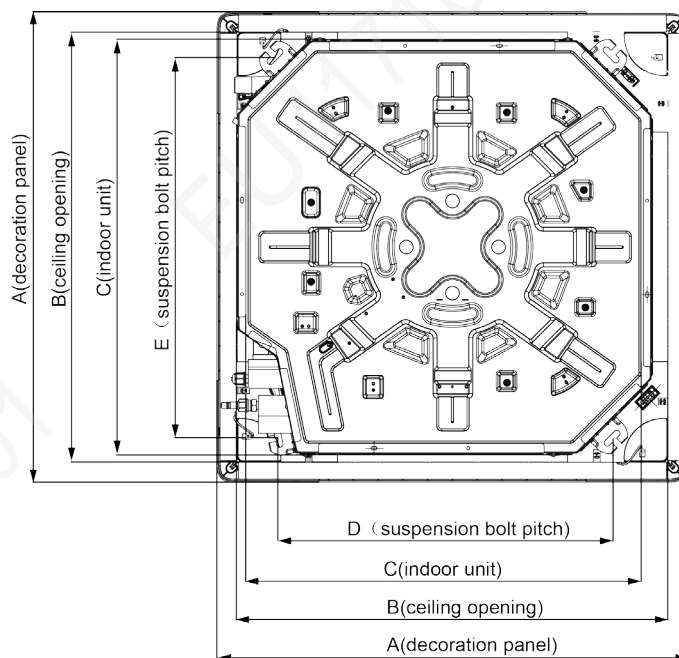

Unit: mm

Model	A	B	C	D	E
GMV-ND22~140T/D1-T	950	890	840	680	780

Unit: mm

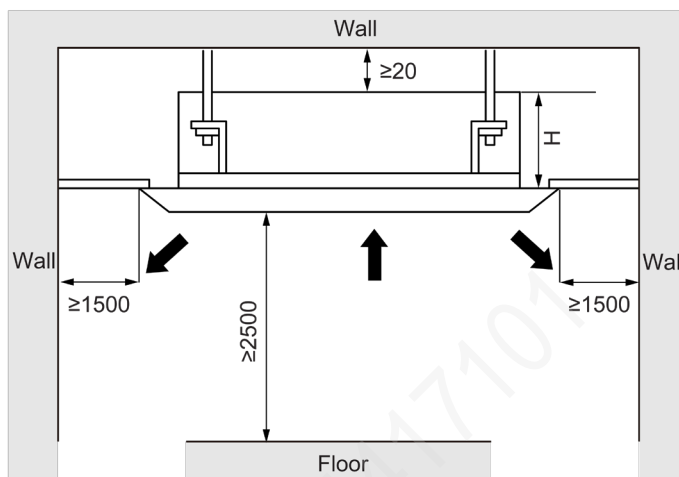

Model	H(mm)
GMV-ND22~71T/D1-T	235
GMV-ND80~112T/D1-T	275
GMV-ND125~140T/D1-T	325

### 7.2.17 Heat Storage Module

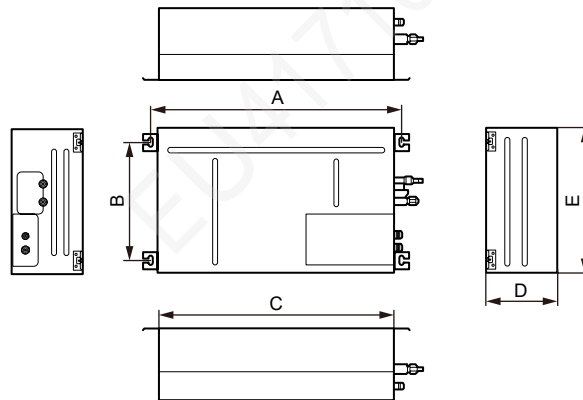

Unit: mm

Model	A (mm)	B (mm)	C (mm)	D (mm)	E (mm)
XRZ180L/A-T	780	364	730	220	450

Installation space

Unit: mm

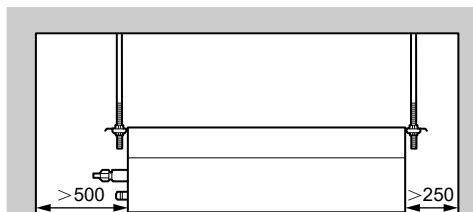

### 7.3 Locating the access panel and air return vent

In addition to consideration of the sufficient maintenance space to be reserved during unit locating, it is also important to locate the access panel. If access panel locating is improper, it will also make future maintenance and repair more difficult.

The access panel size can accommodate the shoulder width of a normal adult. It cannot be smaller than 450 mm × 450 mm. Usually the indoor unit in the air supply mode of air duct is located at the electric box side of the unit, the distance from the electric box is 50 mm to 100 mm, and maintenance of the pipeline part must also be considered. The pipeline maintenance position of the pipeline is mainly considered for the air raise type indoor unit, so the access panel can be located at a position that ensures the distance between one edge and the connection pipe is 200 mm to 250 mm. The schematic diagram is shown below:

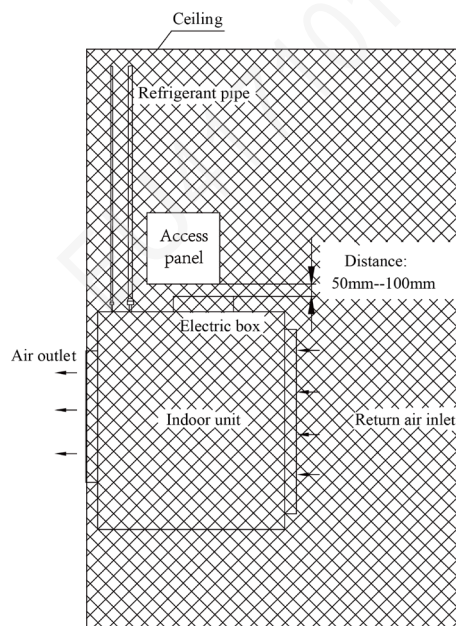

The air return vent position must also be considered for the indoor unit in the air supply mode of air duct. The air return vent is responsible for air return of the unit, and also used to complete maintenance of the indoor fan motor and filter screen. Therefore, in addition to meeting the air return design requirements mentioned above, there is a must to ensure the requirement for replacing the motor and filter screen.

- (1) Do not set the air return vent of the unit near the door, toilet or kitchen; otherwise problems such as condensation and peculiar smell may be caused.
- (2) The length direction of the air return vent cannot be smaller than 2/3 of the air return venting length of the unit.
- (3) If the air return vent is set directly behind the unit, the distance between its position and the unit cannot be greater than 300 mm.
- (4) The width direction of the air return vent cannot be smaller than 200 mm.
- (5) For the design of also using the air return vent as a access panel for the electric box, the maintenance position should also be reserved at the electric box side according to the above principle. At the same time, it is required to consider whether the position of the air return vent can ensure easy removal and replacement of the fan motor and filter screen. Therefore, the air return vent should be enlarged to 1.5 to 2 times of the original circulation area according to the actual conditions and on the basis of satisfying the air volume design. The schematic diagram is shown below:

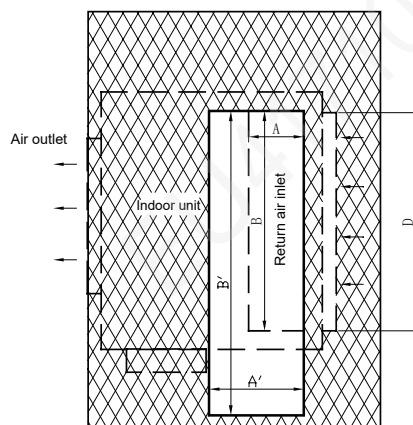

Original air return vent area:  $S = A \times B$

Currently air return vent area:  $S' = A' \times B'$   
 $S' \geq (1.5 \sim 2.0)S$

## 8 REQUIREMENTS FOR COMMUNICATION MODE

### 8.1 Communication Connection Mode between the Indoor Unit and Wired Controller

The indoor unit and the wired controller are connected in one of the following four modes, which are respectively shown in Figure below:

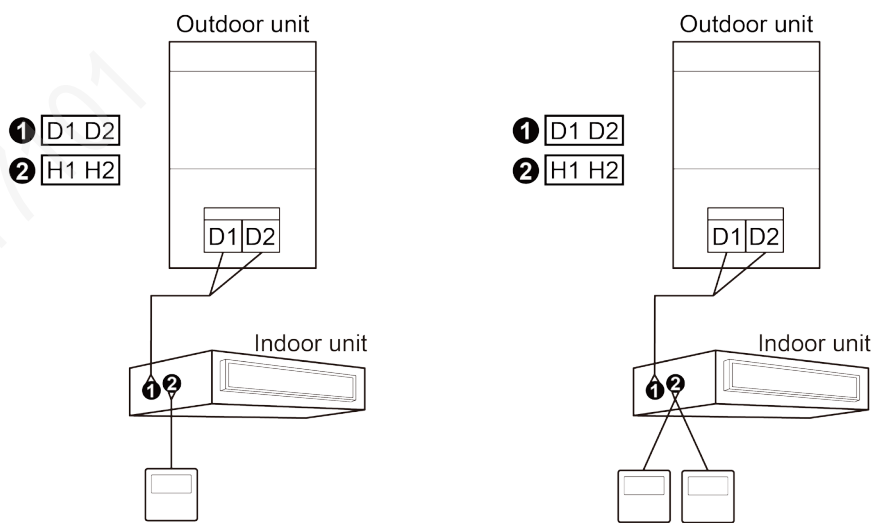

One wire controller controls one indoor unit

Two wire controllers control one indoor unit

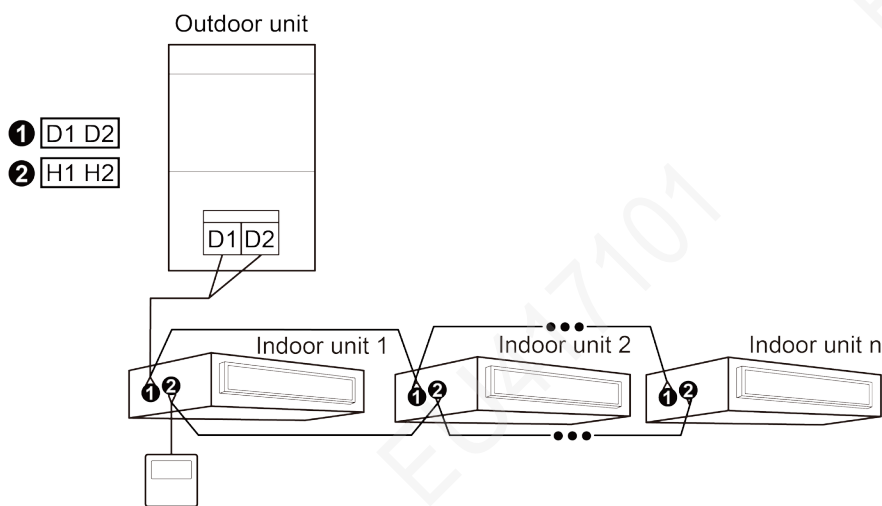

One wire controller controls multiple indoor units

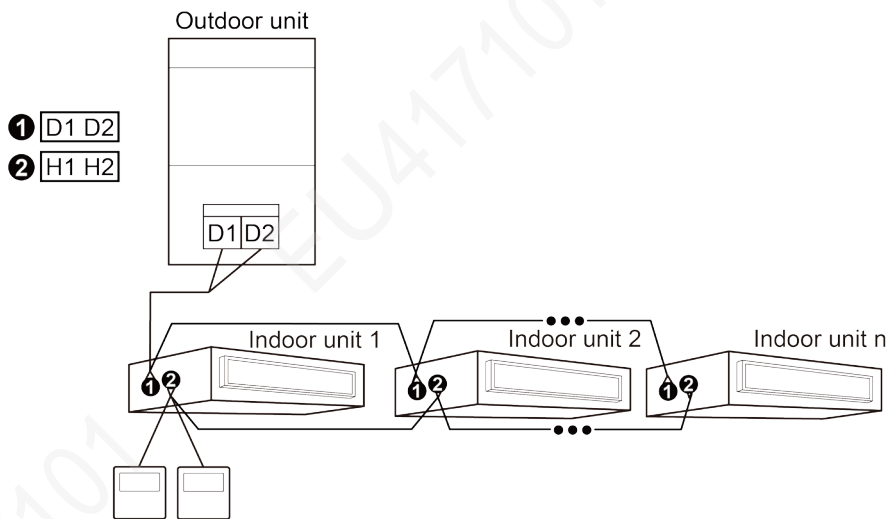

Two wire controllers control multiple indoor units

**Note:**

Multi variable air conditioners floor standing type indoor unit only applicable with One wire controller controls one indoor unit.

For other indoor unit types, when two wired controllers control multiple indoor units at the same time, the wired controller can be connected to any indoor unit, the connected indoor units must belong to the same series, and only one wired controller must be set to a slave wired controller. The number of indoor units controlled by the wired controllers is not more than 16, and the connected indoor units must be on the same indoor unit network.

The slave wired controller can be set in the power-on or power-off status:

- (1) Press and hold the "FUNCTION" button on the wired controller to be set to a slave wired controller for five seconds. The temperature area displays "C00". Continue holding the "FUNCTION" button for five seconds to enter the wired controller parameter setting interface. The temperature area displays "P00" by default.
- (2) Select a P13 parameter code by pressing "▲" or "▼". Press the "MODE" button to switch to parameter value settings. The parameter value blinks. Press "▲" or "▼" to select "02", and then press the "ENTER/CANCEL" button to complete settings.
- (3) Press the "ENTER/CANCEL" button to return to the upper-level menu until quitting parameter settings. The user parameter setting list is as follows:

Parameter Code	Parameter Name	Parameter Range	Default Value	Remarks
P13	Wired controller address settings	01: master wired controller 02: slave wired controller	01	When two wired controllers simultaneously control one or more indoor units, the two wired controllers must use different addresses. The slave wired controller (address: 02) does not have the unit parameter setting function except its own address settings.



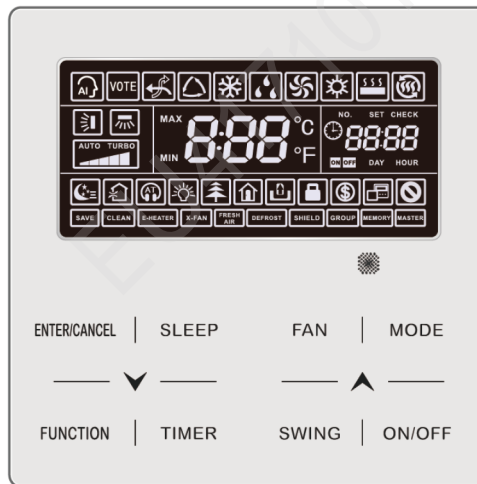

**Notes:**

- ① The default factory setting of all the wired controllers is the master wired controller status.
- ② In the parameter setting status, the “FAN”, “Timer”, “SLEEP”, and “SWING” buttons are invalid. By pressing “ON/OFF”, you can return to the main interface but will not power on/off the unit.
- ③ In the parameter setting status, signals of the remote controller are invalid.

## 8.2 Connection Mode between the Duct Type Indoor Unit and Receiving LED Panel

There are four kinds of wiring methods between the receiver(receiving LED panel) and indoor unit network:

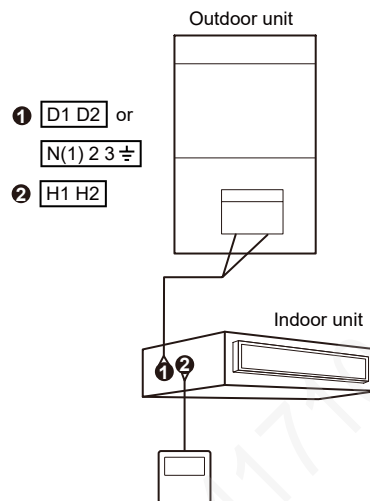

Figure 1 One Receiver Controls One Indoor unit

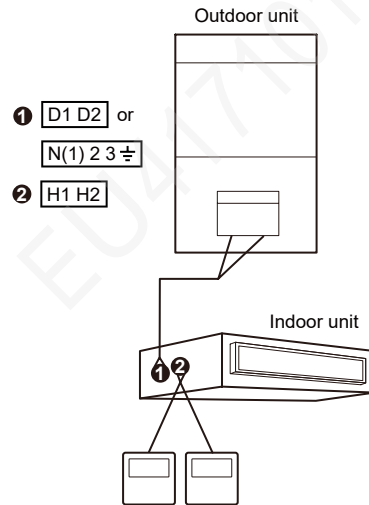

Figure 2 One Receiver and One Wired Controllers Control One Indoor unit

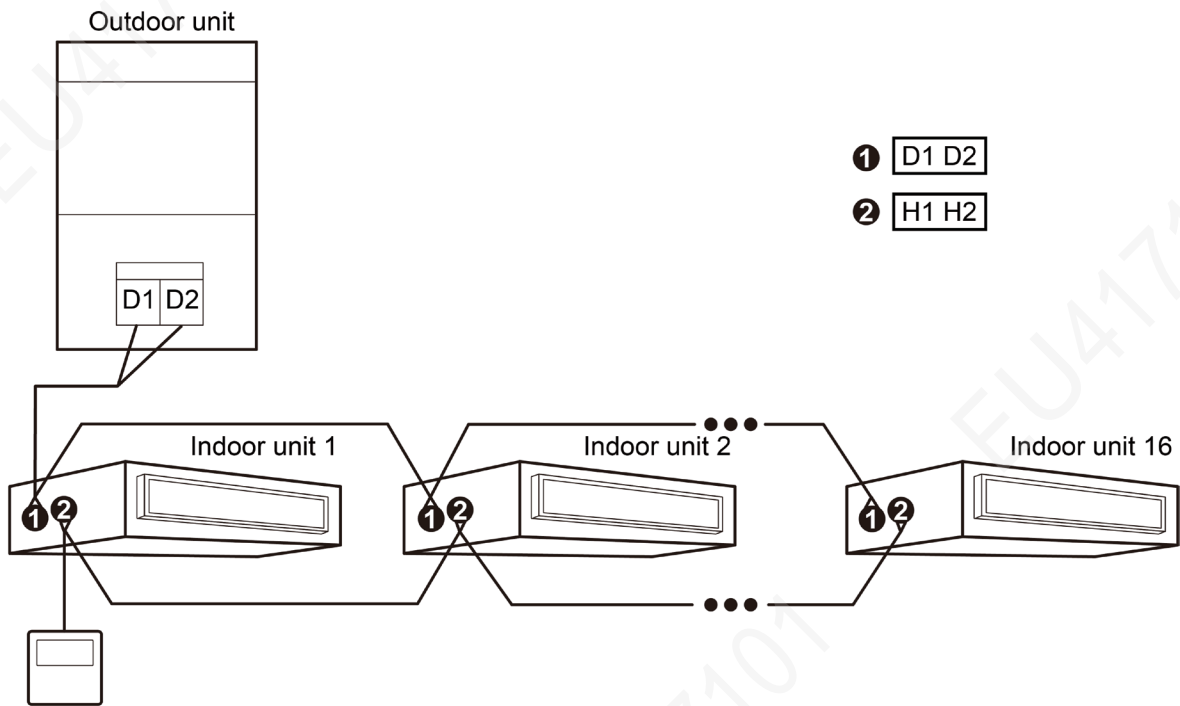

Figure 3 One Receiver Controls Several Multi VRF IDUs Simultaneously

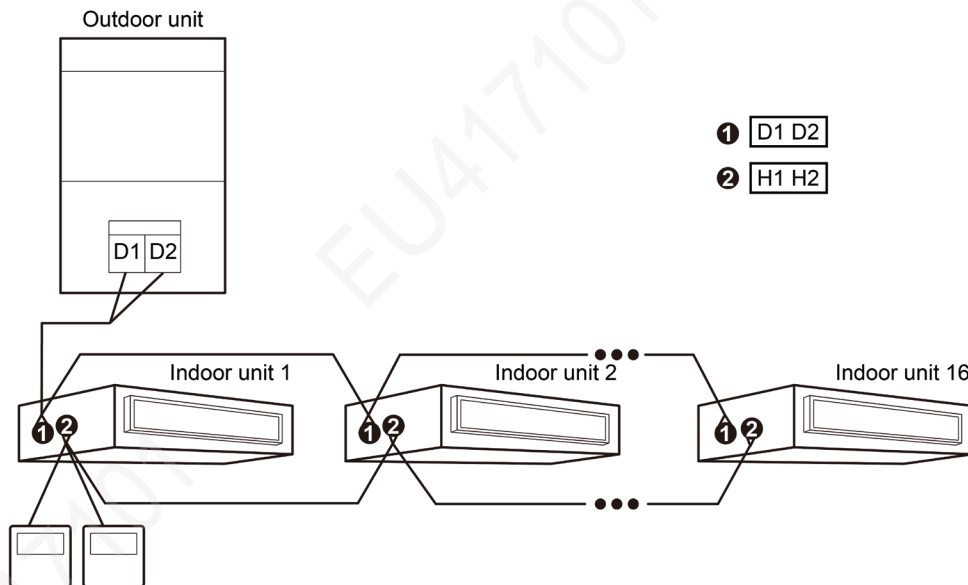

Figure 4 One Receiver and One Wired Controller Control Several Multi VRF IDUs Simultaneously  
Notes:

(1) When the receiver is connected with multi VRF unit, the wiring methods as shown in Figure 1, Figure 2, Figure 3 and Figure 4 can be adopted, but please pay attention to the follow:

① When one receiver or one receiver and one wired controller control several indoor units simultaneously, the receiver can connect any one indoor unit, but the connected indoor unit shall be of the same indoor unit series and the connected indoor unit shall be in the same multi VRF system. When it is applied together with the wired controller, please set the indoor unit quantity of group control in the wired controller.

② When the receiver controls several indoor units simultaneously, the settings of all indoor units controlled by it shall be identical.

(2) In the wiring methods as shown in Figure 2, Figure 4, there can't be two receivers simultaneously and only one wired controller and one receiver are allowable. The wired controller can be set as master or slave wired controller and the receiver address will switch automatically (no need to set receiver address manually) according to the wired controller address (that is master/slave wired controller). The total quantity of receiver and wired controller can't exceed two.

(3) The receiver interface is non-polar, but it can't be connected with heavy current.

(4) Wired controller and remote signal receiving LED panel can be used at the same time.

(5) When selecting remote signal receiving LED panel, select the remote controller.

## 9 OPTIONAL COMPONENTS

Wired controller	XK46, XK79, XK86, XE70-33/H, XE7A-24/H	For the Cassette, Wall Mounted, Console, Floor Ceiling, Concealed Floor Standing, AHU-KIT type units
Remote controller	YAP1F	For the Duct type units
Remote receiving LED panel	JS13	Applicable to the Duct type indoor units
Centralized controller	CE52-24/F(C)	—
E-Smart Zone controller	CE54-24/F(C)	—
Linkage controller	LE60-24/H1	Gate control

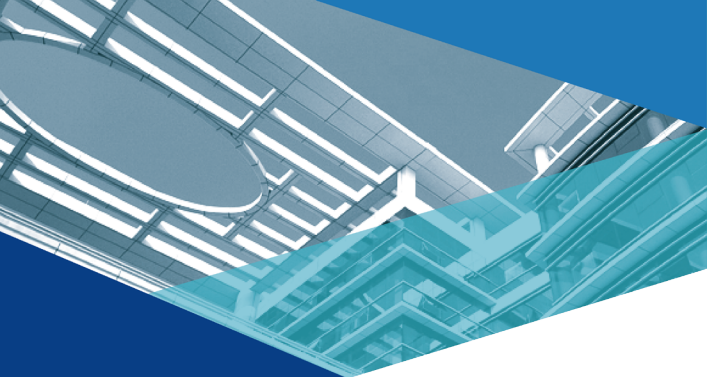

GREE ELECTRIC APPLIANCES, INC. OF ZHUHAI 519070

Add: West Jinji Rd, Qianshan Zhuhai, Guangdong, China

Tel: (+86-756)8522218

Fax: (+86-756)8669426

E-mail: [gree@cn.gree.com](mailto:gree@cn.gree.com) [www.gree.com](http://www.gree.com)

SJ00455893