



Owner's Manual

Original Instructions

Commercial Air Conditioners

Multi Variable Air Conditioners

Wall Mounted Type Indoor Unit

Models:

GMV-N22~71G/A3A-K

GMV-N22~71G/A2A-K

GMV-N22~71G/A4A-K

GMV-N22~71G/A8A-K

GMV-N22~71G/C9A-K

GMV-N22~71G/E3A-K

GMV-N22~71G/A3A-D

GMV-N22~71G/A8A-D

GMV-N22~71G/E3A-D

GMV-N22~71G/B3A-D

GMV-ND22~100G/A3A-T

GMV-ND22~100G/A8A-T

Thank you for choosing commercial air conditioners. Please read this Owner's Manual carefully before operation and retain it for future reference.

If you have lost the Owner's Manual, please contact the local agent or visit www.gree.com or send an email to global@cn.gree.com for the electronic version.

GREE ELECTRIC APPLIANCES, INC. OF ZHUHAI

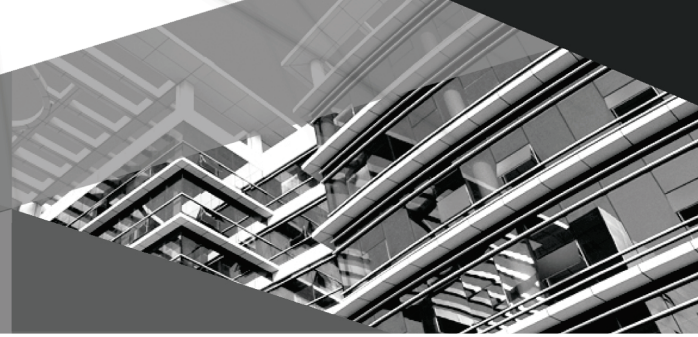

To Users

Thank you for selecting Gree product. Please read this instruction manual carefully before installing and using the product, so as to master and correctly use the product. In order to guide you to correctly install and use our product and achieve expected operating effect, we hereby instruct as below:

- (1) This appliance can be used by children aged from 8 years and above and persons with reduced physical, sensory or mental capabilities or lack of experience and knowledge if they have been given supervision or instruction concerning use of the appliance in a safe way and understand the hazards involved. Children shall not play with the appliance. Cleaning and user maintenance shall not be made by children without supervision.
- (2) In order to ensure reliability of product, the product may consume some power under stand-by status for maintaining normal communication of system and preheating refrigerant and lubricant. If the product is not to be used for long, cut off the power supply; please energize and preheat the unit in advance before reusing it.
- (3) Please properly select the model according to actual using environment; otherwise it may impact the using convenience.
- (4) This product can't be installed at corrosive, inflammable or explosive environment or the place with special requirements, such as kitchen. Otherwise, it will affect the normal operation or shorten the service life of the unit, or even cause fire hazard or serious injury. As for above special places, please adopt special air conditioner with anti-corrosive or anti-explosion function.
- (5) If the product needs to be installed, moved or maintained, please contact our designated dealer or local service center for professional support. Users should not disassemble or maintain the unit by themselves, otherwise it may cause relative damage, and our company will bear no responsibilities.
- (6) All the illustrations and information in the instruction manual are only for reference. In order to make the product better, we will continuously conduct improvement and innovation. If there is adjustment in the product, please subject to actual product.

Exception Clauses

Manufacturer will bear no responsibilities when personal injury or property loss is caused by the following reasons:

- (1) Damage the product due to improper use or misuse of the product;
- (2) Alter, change, maintain or use the product with other equipment without abiding by the instruction manual of manufacturer;
- (3) After verification, the defect of product is directly caused by corrosive gas;
- (4) After verification, defects are due to improper operation during transportation of product;
- (5) Operate, repair, maintain the unit without abiding by instruction manual or related regulations;
- (6) After verification, the problem or dispute is caused by the quality specification or performance of parts and components that produced by other manufacturers;
- (7) The damage is caused by natural calamities, bad using environment or force majeure.

Contents

1 Safety Notices (Please be sure to abide)	1
2 Product Introduction	3
2.1 Outline of the Unit and Main Parts.....	3
2.2 Rated Operating Condition.....	4
3 Preparations for Installation	4
3.1 Location for Installation.....	4
3.2 Schematic diagram of installation spaces.....	4
3.3 Requirements for Communication Line	5
3.4 Wiring Requirements	6
4 Installation Instructions	8
4.1 Installation of Indoor Unit.....	8
4.2 The installation of the rear panel	9
4.3 Preparation of the piping hole.....	9
4.4 Installation of the drainage pipe.....	9
4.5 Installation the connection pipes	10
5 Wiring Work	10
5.1 Connect Cables and Terminals of Wiring Board.....	10
5.2 Power Cord Connection	11
5.3 Connection of Communication Line of IDU and ODU	11
5.4 Connection of Communication Line of Wired Controller.....	12
5.5 Illuminate for Connection of Wired Controller and Indoor Units Network.....	12
5.6 Installation of the indoor unit.....	13
6 The Best Usage Method	13
7 Maintenance Method	14
7.1 Cleaning panel.....	14
7.2 Cleaning the air filters	14
7.3 Check before the usage season.....	15
7.4 Check after the usage season	15
8 Table of Error Codes for Indoor Unit	15
9 Malfunction Analyzing	16
9.1 Service center.....	17
9.2 After-sales service	17
10 Adjusting Method Of The Air Direction	17
10.1 Adjusting air direction up and down.....	17
10.2 Adjusting air direction left and right.....	17

1 Safety Notices (Please be sure to abide)



Warning: If not abide strictly, it may cause severe damage to the unit or the people.



Note: If not abide strictly, it may cause slight or medium damage to the unit or the people.



This sign indicates that the operation must be prohibited. Improper operation may cause severe damage or death to people.



This sign indicates that the items must be observed. Improper operation may cause damage to people or property.



WARNING!









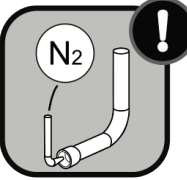
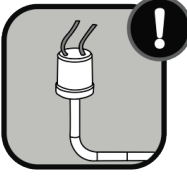
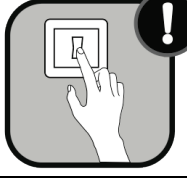

This Multi VRF System shall only be connected to an appliance suitable for the same refrigerant.

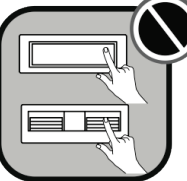

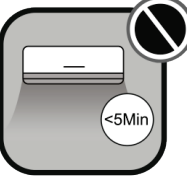
All units in Manual Cover is a partial unit, complying with partial unit of IEC 60335-2-40:2018, and must only be connected to other units that have been confirmed as complying to corresponding partial unit requirements of this international standard.

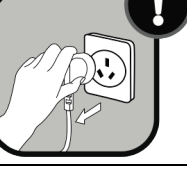
The electrical interface shall comply with electrical security requirement, voltage shall be 220-240(50Hz) or 208-230(60Hz), current shall be referred to the table of “Wiring Requirements” in Section 3.4, and safety class of construction is I.

	<p>Follow this instruction to complete the installation work. Please carefull read this manual before unit startup and service.</p>		<p>Installation should be conducted by dealer or qualified personnel. Please do not attempt to install the unit by yourself. Improper handling may result in waterleakage, electric shock or fire disaster etc.</p>
	<p>Before installation, please check if the power supply is in accordance with the requirements specified on the nameplate. And also take care of the power safety.</p>		<p>Make sure the unit can be earthed properly and soundly after plugging into the socket so as to avoid electric shock. Please do not connect the ground wire to gas pipe, water pipe, lightning rod or telephonenumber.</p>
<p>Dedicated components</p>	<p>Be sure to use the exclusive accessory and part to prevent the water leakage, electric shock and fire accidents.</p>		<p>If refrigerant leakage happens during installation, please ventilate immediately. Poisonous gas will emerge if the refrigerant gas meets fire.</p>
<p>Dedicated</p>	<p>Wire size of power cord should be large enough. The damaged power cord and connection wire should be replaced by exclusive cable.</p>		<p>After connecting the power cord, please fix the electric box cover properly in order to avoid accident.</p>

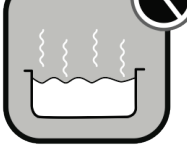
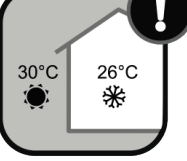
Multi Variable Air Conditioners Wall Mounted Type Indoor Unit

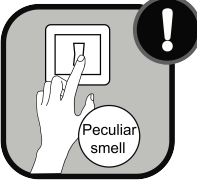
	<p>Never fail to comply with the nitrogen charge requirements. Charge nitrogen when welding pipes.</p>		<p>Never short-circuit or cancel the pressure switch to prevent unit damage.</p>
	<p>Please firstly connect the wired controller before energization, otherwise wired controller can not be used.</p>		<p>Before using the unit, please check if the piping and wiring are correct to avoid water leakage, refrigerant leakage, electric shock, or fire etc.</p>
	<p>Do not insert fingers or objects into air outlet/inlet grille.</p>		<p>Open the door and window and keep good ventilation in the room to avoid oxygen deficit when the gas/oil supplied heating equipment is used.</p>
	<p>Never start up or shut off the air conditioner by means of directly plug or unplug the power cord.</p>		<p>Turn off the unit after it runs at least five minutes; otherwise it will influence oil return of the compressor.</p>
	<p>Do not allow children operate this unit.</p>		<p>Do not operate this unit with wet hands.</p>
	<p>Turn off the unit or cut off the power supply before cleaning the unit, otherwise electric shock or injury may happen.</p>		<p>Never spray or flush water towards unit, otherwise malfunction or electric shock may happen.</p>
	<p>Do not expose the unit to the moist or corrosive circumstances.</p>		<p>Electrify the unit 8 hours before operation. Please switch on for 8 hours before operation. Do not cut off the power when 24 hours short-time halting (to protect the compressor).</p>
	<p>Volatile liquid, such as diluent or gas will damage the unit appearance. Only use soft cloth with a little neutral detergent to clean the outer casing of unit.</p>		<p>Under cooling mode, please don't set the room temperature too low and keep the temperature difference between indoor and outdoor unit within 5.</p>

	<p>If anything abnormal happens (such as burning smell), please power off the unit and cut off the main power supply, and then immediately contact Gree appointed service center. If abnormality keeps going, the unit might be damaged and lead to electric shock or fire.</p>		<p>User is not allowed to repair the unit. Fault service may cause electric shock or fire accidents. Please contact Gree appointed service center for help.</p>
---	---	---	---

Any personal injury or property loss caused by improper installation, improper debug, unnecessary repair or not following the instructions of this manual should not be the responsibility of Gree Electric Appliances, Inc. of Zhuhai.

2 Product Introduction

2.1 Outline of the Unit and Main Parts

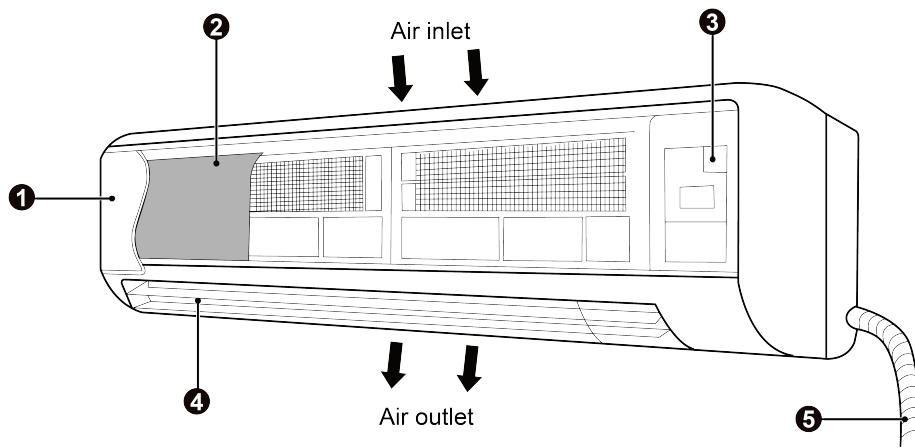

Fig .2.1



Note :

The appearances will be different by the different models of air conditioners.

No.	Part Name	No.	Part Name
①	Surface panel	④	Guide louver
②	Filter	⑤	Drain pipe
③	Wiring cover	—	—

2.2 Rated Operating Condition

Item	Indoor Condition		Outdoor Condition	
	DBTemperature(°C)	WBTemperature(°C)	DBTemperature(°C)	WBTemperature(°C)
Rated Cooling	27	19	35	24
Rated Heating	20	15	7	6

3 Preparations for Installation

3.1 Location for Installation_

- (1) The appliance shall not be installed in the laundry.
- (2) The indoor unit should be installed at 2.5m or higher above the floor.
- (3) The top holder must be strong enough to support unit's weight.
- (4) Drain pipe can drain water out easily.
- (5) There is no obstacle at inlet or outlet. Please ensure good air circulation.
- (6) Keep the unit away from heating source, inflammable gas or smoke.

3.2 Schematic diagram of installation spaces

Unit: mm

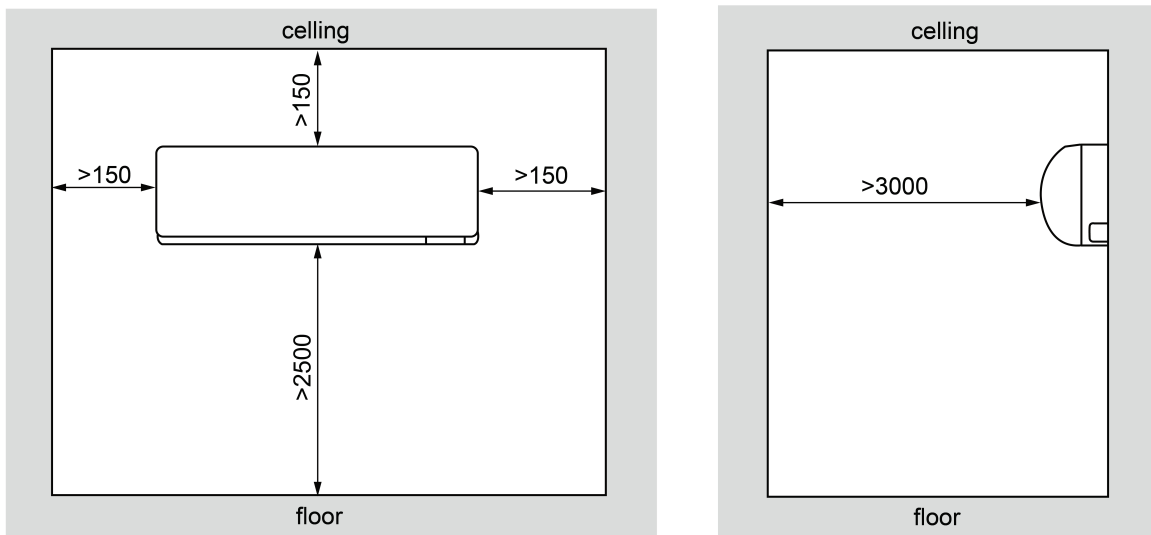

Fig 3.2.1



Notes:

- ① The unit shall be installed by the professional personnel according to this installation instruction to ensure proper use.
- ② Please contact the local Gree appointed service center before installation. Any malfunction caused by the unit that is not installed by the Gree appointed service center

would probably not be dealt with on time because of the inconvenience of the business contact.

- ③ It should be guided under the professional personnel when the air conditioner unit is moved to other place.

3.3 Requirements for Communication Line

! Note:

If the unit is installed in the place with strong electromagnetic interference, shielded wire must be applied on the communication wire between indoor unit and wired controller. Twisted pair line with shielding function must be applied on the communication wire between indoor unit and indoor unit (outdoor unit).

3.3.1 Select communication line for indoor unit and wired controller

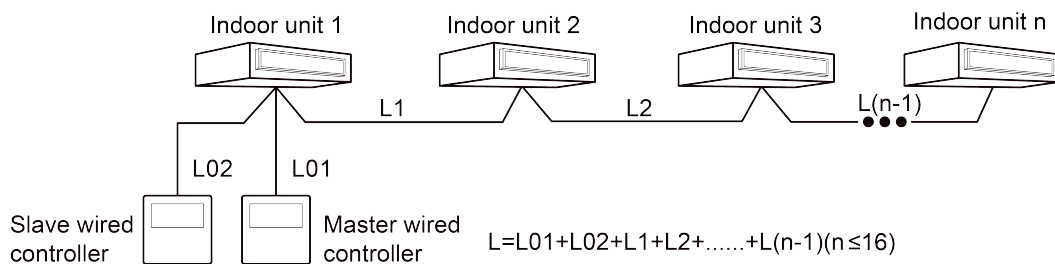

Fig 3.3.1

Material type	Total length of communication line between indoor unit and wired controller L (m/feet)	Wire size (mm ² /AWG)	Material Standard	Remarks
Light/Ordinary polyvinyl chloride sheathed cord. (60227 IEC 52 /60227 IEC 53)	L≤250m (L≤820-1/5feet)	2×0.75~2×1.25 (2×AWG18~2×AWG16)	IEC 60227-5-20 07	1.Total length of communication line can't exceed 250m (820-1/5feet). 2.The cord shall be Circular cord (the cores shall be twisted together). 3.If unit is installed in places with intense magnetic field or strong interference, it is necessary to use shielded wire.

3.3.2 Select communication line for indoor unit and indoor unit (outdoor unit)

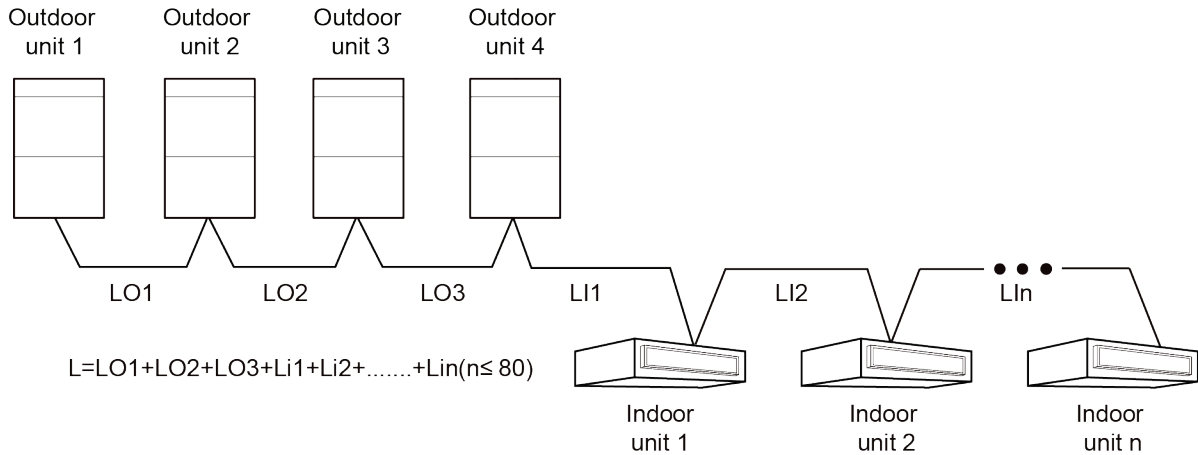

Fig 3.3.2

Material Type	Total Length L (m/feet) of Communication Cable between Indoor Unit and Indoor (Outdoor) Unit	Wire size (mm ² /AWG)	Material Standard	Remarks
Light/Ordinary polyvinyl chloride sheathed cord. (60227 IEC 52 /60227 IEC 53)	L≤1000m (L≤3280-5/6feet)	≥2×0.75 (≥2×AWG18)	IEC 60227-5-2007	1.If the wire diameter is enlarged to 2×1 mm ² (2×AWG16), the total communication line length can reach 1500 m (4921-1/4feet). 2.The cord shall be Circular cord (the cores shall be twisted together). 3.If unit is installed in places with intense magnetic field or strong interference, it is necessary to use shielded wire.

3.4 Wiring Requirements

Model	Power Cord Size	Air Switch capacity (A)	Minimum Sectional Area of Ground Wire(mm ²)	Minimum Sectional Area of Power Cord(mm ²)
GMV-N22G/A3A-K, GMV-N22G/A2A-K GMV-N22G/A4A-K, GMV-N22G/A8A-K GMV-N22G/C9A-K, GMV-N22G/E3A-K	220-240V ~ 50Hz	6	1	1
GMV-N28G/A3A-K, GMV-N28G/A2A-K GMV-N28G/A4A-K, GMV-N28G/A8A-K GMV-N28G/C9A-K, GMV-N28G/E3A-K	220-240V~ 50Hz	6	1	1
GMV-N36G/A3A-K, GMV-N36G/A2A-K GMV-N36G/A4A-K, GMV-N36G/A8A-K GMV-N36G/C9A-K, GMV-N36G/E3A-K	220-240V ~ 50Hz	6	1	1
GMV-N45G/A3A-K, GMV-N45G/A2A-K GMV-N45G/A4A-K, GMV-N45G/A8A-K GMV-N45G/C9A-K, GMV-N45G/E3A-K	220-240V ~ 50Hz	6	1	1
GMV-N50G/A3A-K, GMV-N50G/A2A-K GMV-N50G/A4A-K, GMV-N50G/A8A-K GMV-N50G/C9A-K, GMV-N50G/E3A-K	220-240V ~ 50Hz	6	1	1

Multi Variable Air Conditioners Wall Mounted Type Indoor Unit

Model	Power Cord Size	Air Switch capacity (A)	Minimum Sectional Area of Ground Wire(mm ²)	Minimum Sectional Area of Power Cord(mm ²)
GMV-N56G/A3A-K, GMV-N56G/A2A-K GMV-N56G/A4A-K, GMV-N56G/A8A-K GMV-N56G/C9A-K, GMV-N56G/E3A-K	220-240V ~ 50Hz	6	1	1
GMV-N63G/A3A-K, GMV-N63G/A2A-K GMV-N63G/A4A-K, GMV-N63G/A8A-K GMV-N63G/C9A-K, GMV-N63G/E3A-K	220-240V ~ 50Hz	6	1	1
GMV-N71G/A3A-K, GMV-N71G/A2A-K GMV-N71G/A4A-K, GMV-N71G/A8A-K GMV-N71G/C9A-K, GMV-N71G/E3A-K	220-240V ~ 50Hz	6	1	1
GMV-N22G/A3A-D, GMV-N22G/A8A-D GMV-N22G/E3A-D, GMV-N22G/B3A-D	208-230V ~ 60Hz	6	1	1
GMV-N28G/A3A-D, GMV-N28G/A8A-D GMV-N28G/E3A-D, GMV-N28G/B3A-D	208-230V ~ 60Hz	6	1	1
GMV-N36G/A3A-D, GMV-N36G/A8A-D GMV-N36G/E3A-D, GMV-N36G/B3A-D	208-230V ~ 60Hz	6	1	1
GMV-N45G/A3A-D, GMV-N45G/A8A-D GMV-N45G/E3A-D, GMV-N45G/B3A-D	208-230V ~ 60Hz	6	1	1
GMV-N50G/A3A-D, GMV-N50G/A8A-D GMV-N50G/E3A-D, GMV-N50G/B3A-D	208-230V ~ 60Hz	6	1	1
GMV-N56G/A3A-D, GMV-N56G/A8A-D GMV-N56G/E3A-D, GMV-N56G/B3A-D	208-230V ~ 60Hz	6	1	1
GMV-N63G/A3A-D, GMV-N63G/A8A-D GMV-N63G/E3A-D, GMV-N63G/B3A-D	208-230V ~ 60Hz	6	1	1
GMV-N71G/A3A-D, GMV-N71G/A8A-D GMV-N71G/E3A-D, GMV-N71G/B3A-D	208-230V ~ 60Hz	6	1	1
GMV-ND22G/A3A-T, GMV-ND28G/A3A-T GMV-ND36G/A3A-T, GMV-ND45G/A3A-T GMV-ND50G/A3A-T, GMV-ND56G/A3A-T GMV-ND63G/A3A-T, GMV-ND71G/A3A-T GMV-ND80G/A3A-T, MV-ND90G/A3A-T GMV-ND100G/A3A-T	220-240V ~ 50Hz	6	1	1
GMV-ND22G/A8A-T, GMV-ND28G/A8A-T GMV-ND36G/A8A-T, GMV-ND45G/A8A-T GMV-ND50G/A8A-T, GMV-ND56G/A8A-T GMV-ND63G/A8A-T, GMV-ND71G/A8A-T GMV-ND80G/A8A-T, GMV-ND90G/A8A-T GMV-ND100G/A8A-T	220-240V ~ 50Hz	6	1	1



Notes:

- ① Use copper wire only as unit's power cord. Operating temperature should be within its rated value.
- ② If the power cord is more than 15m long, please increase properly the sectional area of power cord to avoid overload, which may cause accident.
- ③ Above selection requirements: Power cord size is based on BV single-core wire (2~4pc) at 40°C ambient temperature when laying across plastic pipe. Air switch is D type and used at 40°C. If actual installation condition varies, please lower the capacity appropriately according to the specifications of power cord and air switch provided by manufacturer.
- ④ If the supply cord is damaged, it must be replaced by the manufacturer or its service agent or a similarly qualified person in order to avoid a hazard.
- ⑤ Install cut-off device near the unit. The minimum distance between each stage of cut-off device should be 3mm(The same for both indoor unit and outdoor unit).

4 Installation Instructions

4.1 Installation of Indoor Unit

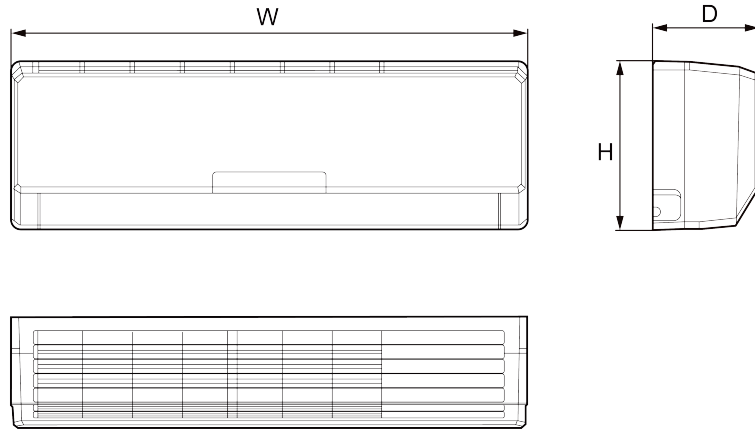

Fig 4.1

Below are dimensions of W, H, D for different models:

Unit: mm

Model	Item	W	H	D
GMV-N22~28G/A3A-K GMV-N22~28G/A2A-K GMV-N22~28G/A4A-K GMV-N22~28G/A8A-K GMV-N22~28G/C9A-K GMV-N22~28G/E3A-K GMV-N22~28G/A3A-D GMV-N22~28G/A8A-D GMV-N22~28G/E3A-D GMV-N22~28G/B3A-D GMV-ND22~28G/A3A-T GMV-ND22~28G/A8A-T		843	275	180
GMV-N36~50G/A3A-K GMV-N36~50G/A2A-K GMV-N36~50G/A4A-K GMV-N36~50G/A8A-K GMV-N36~50G/C9A-K GMV-N36~50G/E3A-K GMV-N36~50G/A3A-D GMV-N36~50G/A8A-D GMV-N36~50G/E3A-D GMV-N36~50G/B3A-D GMV-ND36~50G/A3A-T GMV-ND36~50G/A8A-T		940	298	200
GMV-N56~71G/A3A-K GMV-N56~71G/A2A-K GMV-N56~71G/A4A-K GMV-N56~71G/A8A-K GMV-N56~71G/C9A-K GMV-N56~71G/E3A-K GMV-N56~71G/A3A-D GMV-N56~71G/A8A-D GMV-N56~71G/E3A-D GMV-N56~71G/B3A-D GMV-ND56~71G/A3A-T GMV-ND56~71G/A8A-T		1008	319	221

Model \ Item	W	H	D
GMV-ND80~100G/A3A-T	1350	326	258
GMV-ND80~100G/A8A-T			

4.2 The installation of the rear panel

Unit: mm

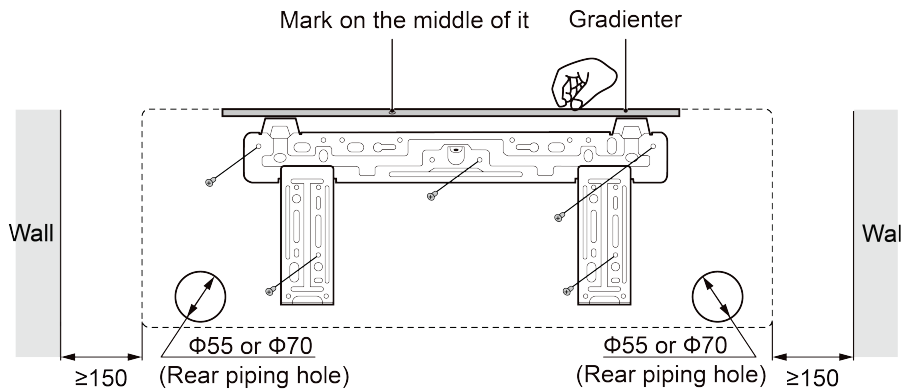

Fig 4.2

- ① Find the horizontal position with the gradienter; Since the drainage pipe is on the left side, it is necessary to adjust the rear panel to make its left side a little bit lower.
- ② Fix the rear panel on the wall by bolts.
- ③ After installing the rear panel, pull it by hands to check if it is secured enough. The hang panel should support the weight of an adult (60kg), and the weight shared by every bolt should be fairly even.
- ④ The diameter showed in Fig.4.2.

4.3 Preparation of the piping hole

- (1) Make the piping hole (Φ55mm or Φ70mm) in the wall at a slight downward slant to the outdoor side. The center of the hole should be determined referring to Fig.4.2.
- (2) Insert the piping-hole sleeve into the hole to prevent the connected piping and wiring from being damaged when passing through the hole.

4.4 Installation of the drainage pipe

- (1) For proper draining, the drain hose should be placed at a downward sloping.
- (2) Do not wrench or bend the drain hose or flood its end by water. (Fig.4.4)
- (3) Wrap the drain hose with heat resistant material.
- (4) It is not allowed to connect the condensate drain pipe into waste pipe or other pipelines which are likely to produce corrosive or peculiar smell to prevent the smell from entering indoors or corrupt the unit.
- (5) It is not allowed to connect the condensate drain pipe into rain pipe to prevent rain water from pouring in and cause property loss or personal injury.
- (6) Condensate drain pipe should be connected into special drain system for air conditioner.

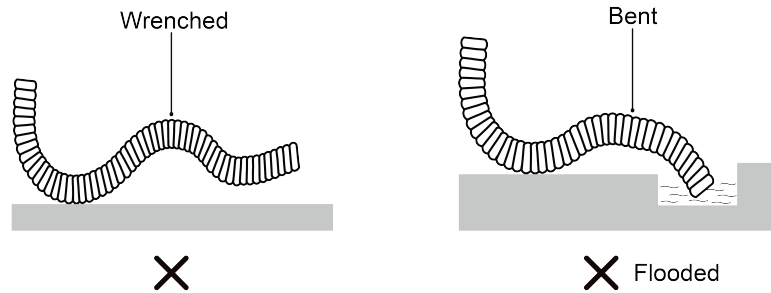

Fig 4.4

4.5 Installation the connection pipes

Connect the ends of the connection pipe with two leading pipes, and then tighten the joint nuts tightly.

Connect the connect pipe with the two relative leading pipe, tie the nut on tie –in of the connect pipe tightly.

! Notes:

- ① Be careful in bending the connection pipes, or you would damage the pipes.
- ② If the tightening torque for the flare nut is too great, leakage would happen.

5 Wiring Work

! Warning!

Before obtaining access to terminals, all supply circuits must be disconnected.

! Notes:

- ① Units must be earthed securely, or it may cause electric shock.
- ② Please carefully read the wiring diagram before carry out the wiring work, incorrect wiring could cause malfunction or even damage the unit.
- ③ The unit should be powered by independent circuit and specific socket.
- ④ The wiring should be in accordance with related regulations in order to ensure the units reliable running.
- ⑤ Install circuit breaker for branch circuit according to related regulations and electrical standards.
- ⑥ Keep cable away from refrigerant pipings, compressor and fan motor.
- ⑦ The communication wires should be separated from power cord and connection wire between indoor unit and outdoor unit.
- ⑧ Adjust the static pressure via wired controller according to site circumstance.

5.1 Connect Cables and Terminals of Wiring Board

Connection of Wire and Patch Board Terminal.

(1) The connection of wire (as shown in fig 5.1.1).

- 1) Strip about 25mm insulation of the wire end by stripping and cutting tool.

- 2) Remove the wiring screws on the terminal board.
 - 3) Shape the tail of wire into ring by needle nose plier, and keep the gauge of ring in accordance with screw.
 - 4) Use the screwdriver for tightening the terminal.
- (2) The connection of stranded wire (as shown in fig 5.1.2).
- 1) Strip about 10mm insulation of the end of stranded wire by stripping and cutting tool.
 - 2) Loosen the wiring screws on terminal board.
 - 3) Insert the wire into the ring tongue terminal and tighten by crimping tool.
 - 4) Use the screwdriver for tightening the terminal.

Unit: mm

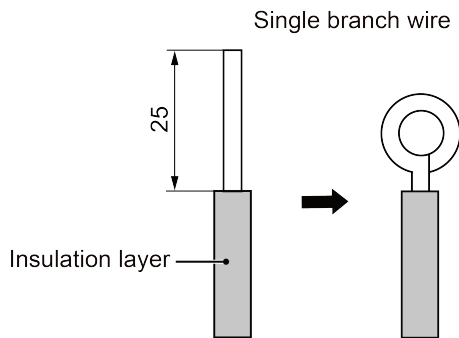

Fig 5.1.1

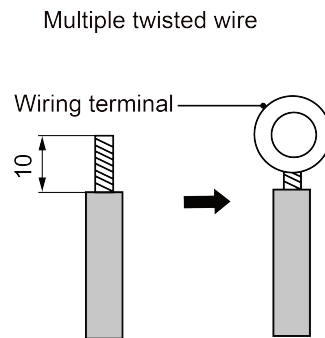
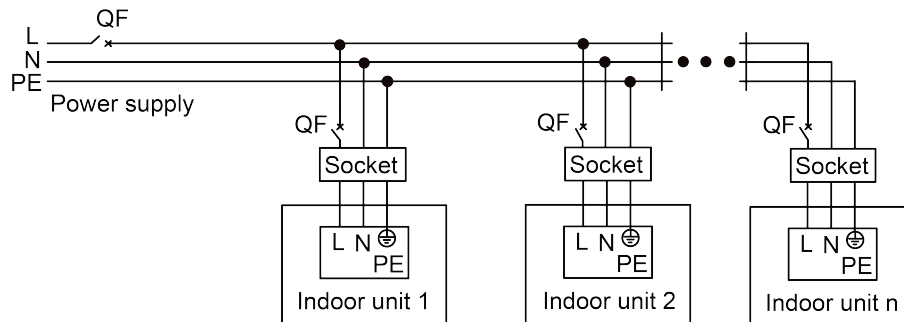

Fig 5.1.2

5.2 Power Cord Connection

! Note:

All indoor units must be unified of power supply so that they can be powered ON/OFF at the same time.



Note: Indoor unit quantity n is according to the outdoor unit capacity.

Fig 5.2

Air conditioning unit uses single-phase power supply, and is equipped with power cord, plug the power cord directly into the unified power outlet.

5.3 Connection of Communication Line of IDU and ODU

- (1) Open the cover of electric box of indoor unit.
- (2) Lead the communication line across the rubber ring.

- (3) Connect the communication line to terminal D1 and D2 on the 4-digit wiring board of indoor unit, as shown in Fig.5.3.1.

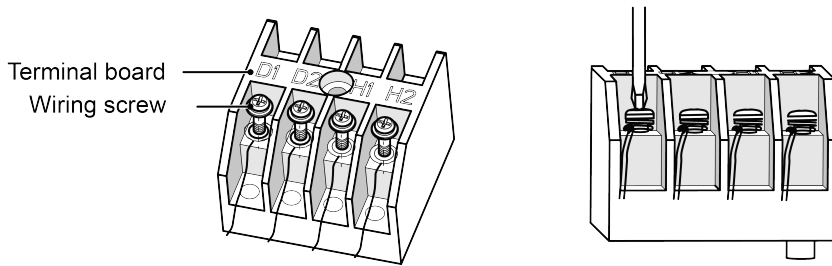

Fig 5.3.1

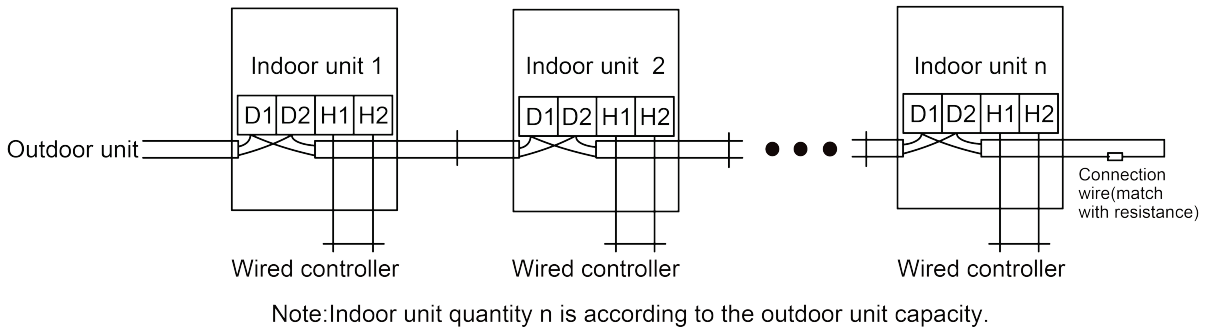

Fig 5.3.2

- (4) Secure the communication line with the wire clamp on the electric box.
- (5) In order to ensure the reliability of communication between IDU and ODU and the communication among each IDU, add a matched resistance (supplied in a package before ex-factory) on the wiring board of the last indoor unit in a series connection. The matched resistance should be connected in parallel between terminal screw D1 and D2, as shown in Fig.5.3.2.

5.4 Connection of Communication Line of Wired Controller

- (1) Open the cover of electric box of indoor unit.
- (2) Lead the communication line of wired controller across the rubber ring.
- (3) Connect the communication wire to terminal H1 and H2 of indoor 4-bit wiring board.
- (4) Fix the communication wire with wire clip on the electric box.

5.5 Illustrate for Connection of Wired Controller and Indoor Units Network

- (1) Communication wire of indoor unit and outdoor unit (or indoor unit) is connected to D1, D2.
- (2) Wired controller is connected to H1, H2.
- (3) One indoor unit can connect two wired controllers that must be set as master one and slave one.
- (4) One wired controller can control 16 indoor units in maximum at the same time.

! Notes:

- ① The type of indoor units must be the same if they are controlled by the same wired controller.
- ② When the indoor unit is controlled by two wired controllers, the addresses of the two wired

controllers should be different through address setting. Address 1 is for main controller; Address 2 is for slave controller. Detailed setting please refer to the instruction manual of wired controller.

5.6 Installation of the indoor unit

- (1) When routing the piping and wiring from the left or right side of the indoor unit, it is necessary to cut off the tailings of the pipe left on the holder of the unit. (Shown in Fig.5.6)
 - 1) Cut down tailings 1 when only the power cord is led.
 - 2) Cut down tailings 1,2 (or 1,2,3) when the connection cord and wire are led.
 - 3) The piping types ①,②,③ are recommended.
- (2) Let the tubing and cord pass through the piping hole after tied up (refer to Fig .5.6 (d)).
- (3) Hang the claw behind the indoor unit on the pothook on the wall panel, and move the unit left and right to check if the body is firm.
- (4) Guarantee that the installation height of the indoor unit should be 2.5m above the floor.

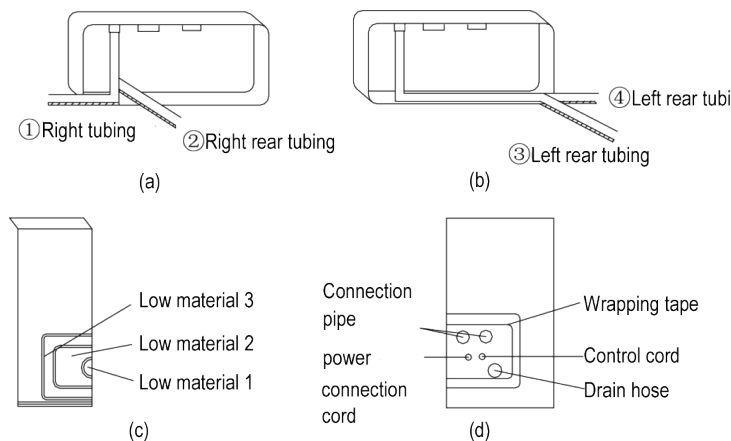
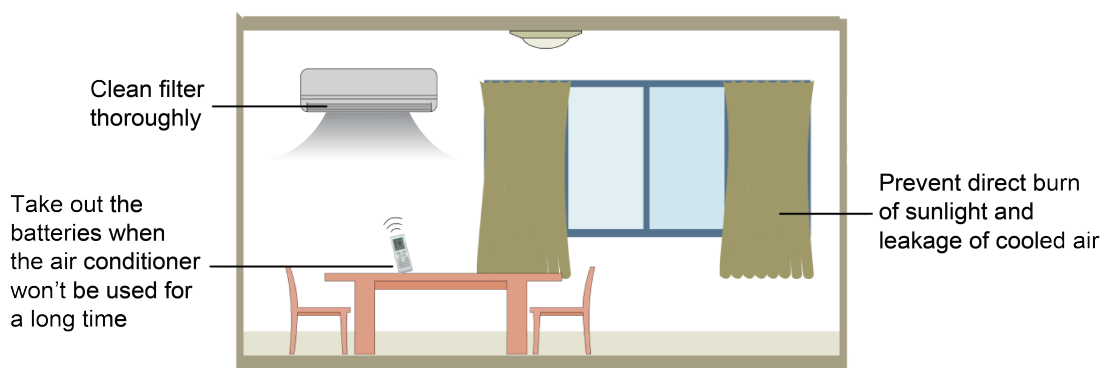

Fig 5.6

6 The Best Usage Method



- (1) Adjust the set temperature properly in proper to prevent electricity wasting. It is better to control the difference of the indoor and outdoor temperatures within 5°C.
- (2) The better effect will be maintained by adjusting the guide louver downward for heating and horizontal for cooling.
- (3) When the air conditioner is running, don't open windows or doors for long time, otherwise the efficiency of unit will be lowered.

- (4) Prevent the cooled air blowing to body directly for long time and making indoor temperature too low, for it is bad for health.
- (5) Do not pour water to unit or clean it by water, otherwise a malfunction or electric shock may happen.
- (6) Do not mangle the power cord and the communication cord. The damaged power cord and communication cord can only be replaced by the specified ones.
- (7) This air conditioner allows voltage fluctuation within $220\pm 10\%V$.
- (8) This air conditioner cannot be used for drying clothes and refrigerating food, etc.

7 Maintenance Method

Warning :

- (1) Do not turn off the unit and cut off the power when cleaning the air conditioner, otherwise electric shock may happen.
- (2) Do not make the air conditioner wet or electric shock may be incurred; Ensure that the air conditioner will not be cleaned by water rinsing under any circumstance.
- (3) Volatile liquid like thinner or gasoline would damage the appearance of the air conditioner. (Only soft dry cloth and wet cloth moistened with neutral detergent could be used to clean the surface panel of the air conditioner.)

7.1 Cleaning panel

Note :

Do take down it before cleaning.

- ① Pull along the direction of arrows to take down the panel.
- ② Clean the panel

Clean it with a soft-hair brush, water and neutral cleaning fluid, and then dry it.

Caution :

Do not use water above 45°C to wash the panel to prevent decoloration or deformation.

Install the panel

As shown in Fig.7.1.1, install the stands of both ends of the panel into the slot and put the middle rotating shaft into the groove, then place the panel and clasp back along the arrow direction.

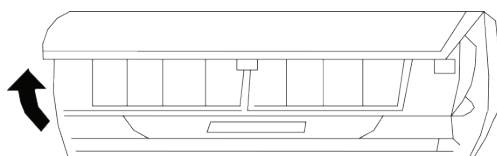

Fig 7.1.1

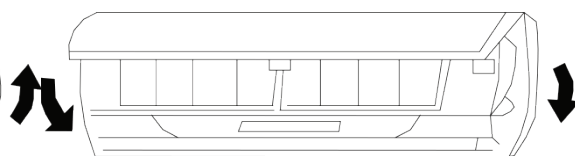

Fig 7.1.2

7.2 Cleaning the air filters

Clean it once every 3 months; When the usage environment has lots of dust, it should be cleaned more frequently.

- (1) Take down the air filter.

As shown in Fig.7.2.1, open the surface panel by holding the both ends of groove along the arrow direction, and then take the air filter out downward.

(2) Clean the filter.

Use cleaner or water to wash the filter; If the filter is too dirty (like oil stain on it), warm water (lower than 45°C) with neutral detergent can be used, then dry it in the shade.

! Note:

- ① Do not clean the filter by hot water higher than 45°C for preventing fade or deformation.
- ② Do not burn it on fire or the filter would catches fire or deformation.

(3) Install air filter

Install the air filter properly along the arrow direction, making the side marked “Front” facing yourself and then place the panel back.

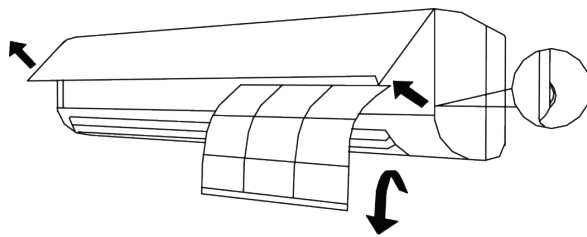

Fig 7.2.1

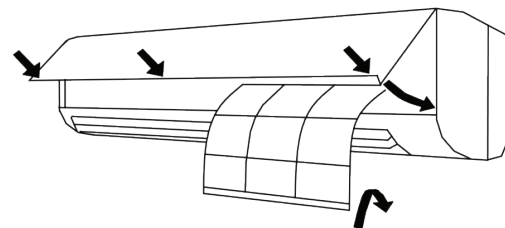

Fig 7.2.2

7.3 Check before the usage season

- (1) Check if there is blockage in the inlet or outlet vent of the air conditioner.
- (2) Check if the earth wire is earthed reliably.
- (3) Check if the batteries in the wireless remote controller have been replaced.
- (4) Check if the air filter has been installed properly

In order to start up the air conditioner smoothly after it has been turned off for a long time period, energize the unit 8 hours before turning it on.

7.4 Check after the usage season

- (1) Clean filter and body of air conditioner.
- (2) Cut off the main power supply of air conditioner.

8 Table of Error Codes for Indoor Unit

Error Code	Content	Error Code	Content	Error Code	Content
L0	Indoor Unit Error	L9	Quantity Of Group Control Indoor Units Setting Error	d8	Water Temperature Sensor Error
L1	Indoor Fan Protection	LA	Indoor Units Incompatibility Error	d9	Jumper Cap Error
L2	E-heater Protection	LH	Low Air Quality Warning	dA	Indoor Unit Network Address Error
L3	Water Full Protection	LC	Outdoor-Indoor Incompatibility Error	dH	Wired Controller Circuit Board Error
L4	Wired Controller Power Supply Error	d1	Indoor Unit Circuit Board Error	dC	Capacity DIP Switch Setting Error

Error Code	Content	Error Code	Content	Error Code	Content
L5	Anti-freezing Protection	d3	Ambient Temperature Sensor Error	dE	Indoor Unit CO ₂ Sensor Error
L7	No Master Indoor Unit Error	d4	Inlet Pipe Temperature Sensor Error	C0	Communication Error
L8	Power Insufficiency Protection	d6	Outlet Pipe Temperature Sensor Error	AJ	Filter Cleaning Reminding
db	Special Code: Project Debugging Code	dL	Outlet Air Temperature Sensor Error	—	—

9 Malfunction Analyzing



Warning:

Do not repair the air conditioner by yourself for the incorrect repair would lead to electric shock or fire. Please contact the service center and have the unit repaired by the specialized personnel. Check the following items before contacting the service center, as it could save your time and cost.

Malfunction Phenomena	Malfunction Analyzing
The air conditioner could not start up just after turned off	The over load protection switch of the unit makes it run after 3 minutes delay.
Odor gave out when the unit just was turned on	Odors or cigarette smoke which has been absorbed in is discharged out.
Slight bicker was heard when the unit was running.	This is the sound of the running refrigerant.
Mist came from the air outlet vent when cooling.	Indoor air is cooled rapidly.
Creak sound was heard when the unit was running or after it was turned off.	It is the sound emitted by the expansion of the panel and other parts because of the temperature change.
The air conditioner failed to run.	Is the power supply cut off ? Is the power supply connected ? Is the circuit protector started aside ? Is the voltage too high or too low ? If TIMER had been set on the wireless remote controller ?
The cooling (heating) effect of the air conditioner was not good.	Is the temperature set properly ? Is the inlet, outlet vent of the outdoor unit blocked ? Is the air filter too dirty to cause blockage ? Are windows and doors closed ? Is the air speed too low ? Is there other heat source in the room ?
The wireless remote controller cannot work.	In the event that the battery is replaced but the wireless remote control still malfunctions, then open the back cover and press. "ACL" button to make it normal. When the air conditioner is under abnormal interference or its functions are changed too frequently, then the wireless remote controller would works improperly. At this time, it is available to resume the normal operation through de-energizing and then energizing the wireless controller again. Is the controller within the receiving area? or is there blockage? Check if the voltages of batteries in the wireless remote controller are sufficient; Otherwise change the batteries.

9.1 Service center

When the following phenomena appeared, please stop operating immediately, cut off the main power supply of the unit and then contact the service center of the air conditioner.

- (1) Harsh sound heard when running;
- (2) The fuse or protector opened frequently;
- (3) Substance or water pulled in the unit involuntarily;
- (4) Water leakage in room;
- (5) Power cord overheated;
- (6) Abnormal odor is given out when running.

9.2 After-sales service

When quality or other problems arise upon the purchased air conditioner, please contact the local service center.

10 Adjusting Method Of The Air Direction

10.1 Adjusting air direction up and down

- (1) Controlling the guide louver motor by the wireless remote controller can make the guide louver swing up and down, or makes the guide louver stop at a certain angle to have air supplied.
- (2) Press the SWING button on the wireless remote controller to make the guide louver swing up and down; Repress again to stop the operation.

10.2 Adjusting air direction left and right

Moving the vertical louver left and right can adjust the left and right direction of air outlet, or adjust the air outlet to reach every corner of the room by 3 different outlet directions to make the indoor temperature more even.

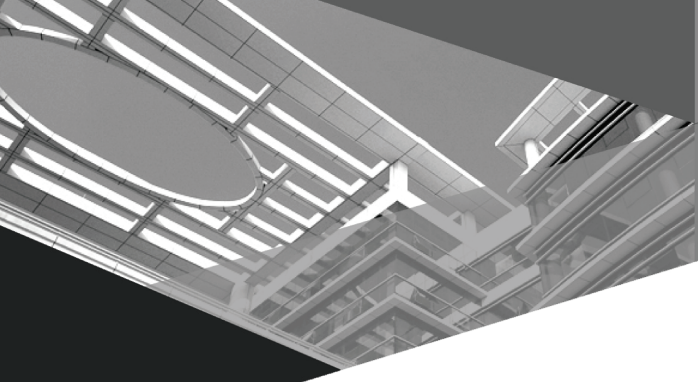

GREE ELECTRIC APPLIANCES, INC. OF ZHUHAI

Add: West Jinji Rd, Qianshan, Zhuhai, Guangdong, China, 519070

Tel: (+86-756) 8522218

Fax: (+86-756) 8669426

E-mail: global@cn.gree.com www.gree.com



66174100044