



Service Manual

GREE ELECTRIC APPLIANCES, INC. OF ZHUHAI



Table of Contents

Part I : Technical Information	2
1. Summary	2
2. Specifications	6
2.1 Specification Sheet.....	6
2.2 Capacity Variation Ratio According to Temperature	14
2.3 Cooling and Heating Data Sheet in Rated Frequency.....	14
3. Outline Dimension Diagram	15
3.1 Indoor Unit.....	15
3.2 Outdoor Unit.....	16
4. Refrigerant System Diagram	18
5. Electrical Part	19
5.1 Wiring Diagram	19
5.2 PCB Printed Diagram	23
6. Function and Control	28
6.1 Remote Controller Introduction(YAP1F2).....	28
6.2 Remote Controller Introduction(YAP1FB2).....	32
6.3 Remote Controller Introduction (YAW1F10)	37
6.4 GREE+ App Operation Manual	40
6.5 Ewpe Smart App Operation Manual.....	41
6.6 Brief Description of Models and Functions.....	42
Part II : Installation and Maintenance	44
7. Notes for Installation and Maintenance	44
8. Installation	50
8.1 Installation Dimension Diagram.....	50
8.2 Installation Parts-checking	52
8.3 Selection of Installation Location.....	52

8.4 Electric Connection Requirement	52
8.5 Installation of Indoor Unit.....	53
8.6 Installation of Outdoor unit.....	55
8.7 Vacuum Pumping and Leak Detection.....	56
8.8 Check after Installation and Test operation.....	57
9. Maintenance.....	58
9.1 Error Code List.....	58
9.2 Procedure of Troubleshooting	63
9.3 Troubleshooting for Normal Malfunction	78
10. Exploded View and Parts List	80
10.1 Indoor Unit.....	80
10.2 Outdoor Unit	86
11. Removal Procedure	92
11.1 Removal Procedure of Indoor Unit.....	92
11.2 Removal Procedure of Outdoor Unit.....	97
 Appendix	 112
Appendix 1: Reference Sheet of Celsius and Fahrenheit.....	112
Appendix 2: Configuration of Connection Pipe	112
Appendix 3: Pipe Expanding Method.....	113
Appendix 4: List of Resistance for Temperature Sensor.....	114

1. Summary

Indoor Unit:

GWH07QA-K6DNA1C/I

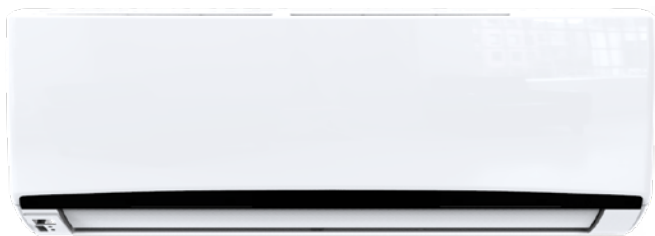

GWH07QA-K6DNA2C/I



GWH07QA-K6DNB2C/I GWH09QAXA-K6DNB2C/I
GWH12QBXB-K6DNB2C/I GWH24QDXE-K6DNB2A/I

GWH07QA-K6DNB4C/I GWH09QAXA-K6DNB4C/I
GWH12QBXB-K6DNB4C/I GWH24QDXE-K6DNB4A/I



GWH07QA-K6DNB6C/I GWH09QAXA-K6DNB6C/I
GWH12QBXB-K6DNB6C/I GWH24QDXE-K6DNB6A/I

GWH07QA-K6DNC4C/I

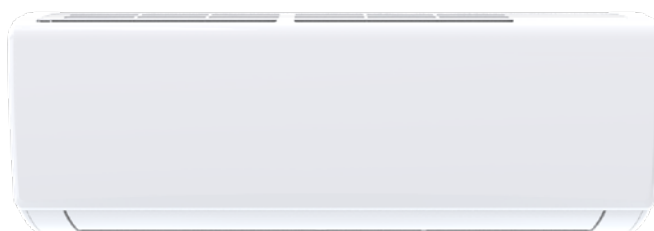
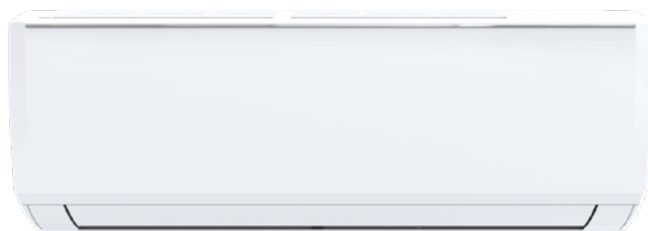

GWH07QA-K6DNC6C/I GWH09QAXA-K6DNC6C/I
GWH12QBXB-K6DNC6C/I GWH24QDXE-K6DNC6A/I

GWH07QA-K6DND6C/I

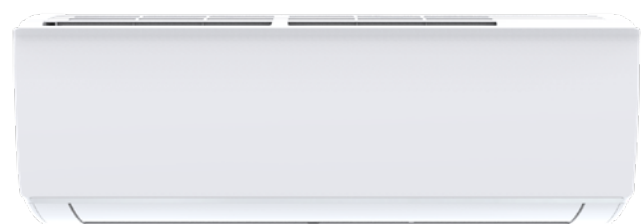

GWH07QA-K6DND8C/I GWH09QAXA-K6DND8C/I
GWH12QBXB-K6DND8C/I GWH24QDXE-K6DND8A/I

GWH07QA-K6DNE4C/I

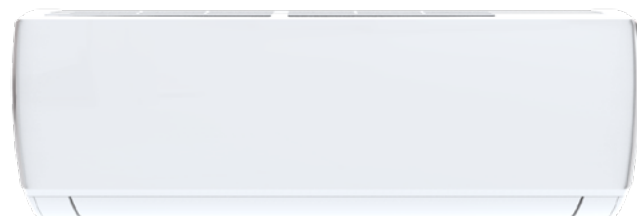

Model list:

No	Model	Product code	Indoor model	Indoor product code	Outdoor model	Outdoor product code	Remote Controller
1	GWH07QA-K6DNB2C	CB432026400	GWH07QA-K6DNB2C/I	CB432N26400	GWH07AGA-K6DNA1C/O	CB385W05900	YAP1F2 (WiFi)
2	GWH07QA-K6DNB4C	CB434021300	GWH07QA-K6DNB4C/I	CB434N21300			
3	GWH07QA-K6DNB4C	CB434021301	GWH07QA-K6DNB4C/I	CB434N21301			
4	GWH07QA-K6DNA1C	CB419018400	GWH07QA-K6DNA1C/I	CB419N18400			
5	GWH07QA-K6DNA2C	CB426008400	GWH07QA-K6DNA2C/I	CB426N08400			
6	GWH07QA-K6DNB6C	CB435013500	GWH07QA-K6DNB6C/I	CB435N13500			
7	GWH07QA-K6DNC4C	CB444014500	GWH07QA-K6DNC4C/I	CB444N14500			
8	GWH07QA-K6DNC6C	CB443010600	GWH07QA-K6DNC6C/I	CB443N10600			
9	GWH07QA-K6DNC6C	CB443010601	GWH07QA-K6DNC6C/I	CB443N10601			
10	GWH07QA-K6DND6C	CB460011100	GWH07QA-K6DND6C/I	CB460N11100			
11	GWH07QA-K6DND8C	CB459009400	GWH07QA-K6DND8C/I	CB459N09400			
12	GWH07QA-K6DND8C	CB459009401	GWH07QA-K6DND8C/I	CB459N09401			
13	GWH07QA-K6DNE4C	CB470007900	GWH07QA-K6DNE4C/I	CB470N07900			
14	GWH07QAXA-K6DNC2C	CB439019300	GWH07QAXA-K6DNC2C/I	CB439N19300			
15		CB439019301		CB439N19301			
16	GWH07QAXA-K6DNE2C	CB462003000	GWH07QAXA-K6DNE2C/I	CB462N03000			
17	GWH07QAXA-K6DNE6C	CB465005300	GWH07QAXA-K6DNE6C/I	CB465N05300			
18	GWH07QAXA-K6DNE6C	CB465005301	GWH07QAXA-K6DNE6C/I	CB465N05301			
19	GWH09QAXA-K6DNB6C	CB435015400	GWH09QAXA-K6DNB6C/I	CB435N15400	GWH09AGA-K6DNA1C/O	CB385W05100	YAP1FB2 (WiFi)
20	GWH09QAXA-K6DNB2C	CB432029800	GWH09QAXA-K6DNB2C/I	CB432N29800			
21	GWH09QAXA-K6DNB4C	CB434025200	GWH09QAXA-K6DNB4C/I	CB434N25200			
22	GWH09QAXA-K6DNC2C	CB439019600	GWH09QAXA-K6DNC2C/I	CB439N19600			
23	GWH09QAXA-K6DNC6C	CB443011800	GWH09QAXA-K6DNC6C/I	CB443N11800			
24	GWH09QAXA-K6DNE2C	CB462003200	GWH09QAXA-K6DNE2C/I	CB462N03200			
26	GWH09QAXA-K6DND8C	CB459011300	GWH09QAXA-K6DND8C/I	CB459N11300			
27	GWH09QAXA-K6DND8C	CB459011301	GWH09QAXA-K6DND8C/I	CB459N11301			

No	Model	Product code	Indoor model	Indoor product code	Outdoor model	Outdoor product code	Remote Controller
28	GWH12QBXB-K6DNB2C	CB432029900	GWH12QBXB-K6DNB2C/I	CB432N29900	GWH12AGBXB-K6DNA4C/O	CB558W02600	YAW1F10
29	GWH12QBXB-K6DNB4C	CB434025300	GWH12QBXB-K6DNB4C/I	CB434N25300			
30	GWH12QBXB-K6DNB6C	CB435015500	GWH12QBXB-K6DNB6C/I	CB435N15500			
31	GWH12QBXB-K6DNC2C	CB439019700	GWH12QBXB-K6DNC2C/I	CB439N19700			
32	GWH12QBXB-K6DNC6C	CB443012000	GWH12QBXB-K6DNC6C/I	CB443N12000			
33	GWH12QBXB-K6DNE2C	CB462003300	GWH12QBXB-K6DNE2C/I	CB462N03300			
34	GWH12QBXB-K6DND8C	CB459011600	GWH12QBXB-K6DND8C/I	CB459N11600			
35	GWH24QDXE-K6DNB6A	CB435015700	GWH24QDXE-K6DNB6A/I	CB435N15700	GWH24QDXE-K6DNB6A/O	CB435W15700	
36	GWH24QDXE-K6DNB2A	CB432029700	GWH24QDXE-K6DNB2A/I	CB432N29700			
37	GWH24QDXE-K6DNB4A	CB434025100	GWH24QDXE-K6DNB4A/I	CB434N25100			
38	GWH24QDXE-K6DNC2A	CB439019500	GWH24QDXE-K6DNC2A/I	CB439N19500			
39	GWH24QDXE-K6DNC6A	CB443011900	GWH24QDXE-K6DNC6A/I	CB443N11900			
40	GWH24QDXE-K6DNE2A	CB462003100	GWH24QDXE-K6DNE2A/I	CB462N03100			
41	GWH24QDXE-K6DND8A	CB459011700	GWH24QDXE-K6DND8A/I	CB459N11700			

2. Specifications

2.1 Specification Sheet

****See chapter 1 for specific models**

Model			GWH07QA-K6DN**C GWH07QAXA-K6DN**C
Product Code			CB432026400 CB434021300/CB434021301 CB419018400 CB426008400 CB435013500 CB443010600/CB443010601 CB444014500 CB460011100 CB459009400/CB459009401 CB470007900 CB439019300/CB439019301 CB465005300/CB465005301 CB462003000
Power Supply	Rated Voltage	V~	220-240
	Rated Frequency	Hz	50
	Phases		1
Power Supply Mode			Outdoor
Cooling Capacity		W	2350
Heating Capacity		W	2500
Cooling Power Input		W	681
Heating Power Input		W	649
Cooling Current Input		A	3.3
Heating Current Input		A	3.5
Rated Input		W	1230
Rated Cooling Current		A	6
Rated Heating Current		A	7
Air Flow Volume		m ³ /h	500/420/390/300
Dehumidifying Volume		L/h	0.6
EER		W/W	3.45
COP		W/W	3.85
SEER		W/W	/
SCOP(Average/WarmerColder)		W/W	/
Application Area		m ²	10-16
Indoor Unit	Model		GWH07QA-K6DN**C/I GWH07QAXA-K6DN**C/I
	Product Code		CB432N26400 CB434N21300/CB434N21301 CB419N18400 CB426N08400 CB435N13500 CB443N10600/CB443N10601 CB444N14500 CB460N11100 CB459N09400/CB459N09401 CB470N07900 CB439N19300/CB439N19301 CB465N05300/CB465N05301 CB462N03000
	Fan Type		Cross-flow
	Fan Diameter Length(DXL)	mm	Φ98×507
	Cooling Speed	r/min	1300/1200/1000/800
	Heating Speed	r/min	1200/1100/1000/800
	Fan Motor Power Output	W	10
	Fan Motor RLA	A	0.215
	Fan Motor Capacitor	μF	1
	Evaporator Form		Aluminum Fin-copper Tube
	Evaporator Pipe Diameter	mm	Φ5
	Evaporator Row-fin Gap	mm	2-1.4
	Evaporator Coil Length (LXDXW)	mm	510×22.8×266.7
	Swing Motor Model		MP24AA
	Swing Motor Power Output	W	1.5
	Fuse Current	A	3.15
	Sound Pressure Level	dB (A)	Cooling:40/38/33/27 Heating:38/35/33/28
	Sound Power Level	dB (A)	Cooling:54/51/46/38 Heating:48/45/43/38
	Dimension (WXHXD)	mm	713X270X195
	Dimension of Carton Box (LXWXH)	mm	760X334X259
	Dimension of Package (LXWXH)	mm	763X350X270
Net Weight	kg	8.2	
Gross Weight	kg	9.7	

Outdoor Unit	Outdoor Unit Model		GWH07AGA-K6DNA1C/O
	Outdoor Unit Product Code		CB385W05900
	Compressor Manufacturer		ZHUHAI LANDA COMPRESSOR CO., LTD
	Compressor Model		QXF-N075zC170
	Compressor Oil		FW68DA or equivalent
	Compressor Type		Rotary
	Compressor LRA.	A	/
	Compressor RLA	A	3
	Compressor Power Input	W	633
	Compressor Overload Protector		/
	Throttling Method		Capillary
	Set Temperature Range	°C	16~30
	Cooling Operation Ambient Temperature Range	°C	-15~43
	Heating Operation Ambient Temperature Range	°C	-15~24
	Condenser Form		Aluminum Fin-copper Tube
	Condenser Pipe Diameter	mm	Φ7
	Condenser Rows-fin Gap	mm	1-1.2
	Condenser Coil Length (LXDXW)	mm	635×19.05×418
	Fan Motor Speed	rpm	940±20
	Fan Motor Power Output	W	20
	Fan Motor RLA	A	0.3
	Fan Motor Capacitor	μF	1.5
	Outdoor Unit Air Flow Volume	m ³ /h	1400
	Fan Type		Axial-flow
	Fan Diameter	mm	350
	Defrosting Method		Automatic Defrosting
	Climate Type		T1
	Isolation		I
	Moisture Protection		IPX4
	Permissible Excessive Operating Pressure for the Discharge Side	MPa	4.3
	Permissible Excessive Operating Pressure for the Suction Side	MPa	2.5
	Sound Pressure Level (H/M/L)	dB (A)	51
Sound Power Level (H/M/L)	dB (A)	61	
Dimension(WXHXD)	mm	710X450X293	
Dimension of Carton Box (LXWXH)	mm	761X327X500	
Dimension of Package(LXWXH)	mm	764X330X525	
Net Weight	kg	20.8	
Gross Weight	kg	22.8	
Refrigerant		R32	
Refrigerant Charge	kg	0.45	
Connection Pipe	Connection Pipe Length	m	5
	Connection Pipe Gas Additional Charge	g/m	16
	Outer Diameter Liquid Pipe		1/4"
	Outer Diameter Gas Pipe		3/8"
	Max Distance Height	m	10
	Max Distance Length	m	15
	Note: The connection pipe applies metric diameter.		

The above data is subject to change without notice. Please refer to the nameplate of the unit.

Model			GWH09QAXA-K6DNB6C GWH09QAXA-K6DNB2C GWH09QAXA-K6DNB4C GWH09QAXA-K6DNC2C GWH09QAXA-K6DNC6C GWH09QAXA-K6DNE2C GWH09QAXA-K6DND8C
Product Code			CB435015400 CB432029800 CB434025200 CB439019600 CB443011800 CB462003200 CB459011300/CB459011301
Power Supply	Rated Voltage	V~	220-240
	Rated Frequency	Hz	50
	Phases		1
Power Supply Mode			Outdoor
Cooling Capacity		W	2650
Heating Capacity		W	2852
Cooling Power Input		W	780
Heating Power Input		W	781
Cooling Current Input		A	3.8
Heating Current Input		A	3.9
Rated Input		W	1320
Rated Cooling Current		A	6.5
Rated Heating Current		A	7
Air Flow Volume		m ³ /h	500/420/390/300
Dehumidifying Volume		L/h	0.8
EER		W/W	3.4
COP		W/W	3.65
SEER		W/W	/
SCOP(Average/WarmerColder)		W/W	/
Application Area		m ²	12-18
Indoor Unit	Model		GWH09QAXA-K6DNB6C/I GWH09QAXA-K6DNB2C/I GWH09QAXA-K6DNB4C/I GWH09QAXA-K6DNC2C/I GWH09QAXA-K6DNC6C/I GWH09QAXA-K6DNE2C/I GWH09QAXA-K6DND8C/I
	Product Code		CB435N15400 CB432N29800 CB434N25200 CB439N19600 CB443N11800 CB462N03200 CB459N11300/CB459N11301
	Fan Type		Cross-flow
	Fan Diameter Length(DXL)	mm	Φ98×507
	Cooling Speed	r/min	1300/1200/1000/800
	Heating Speed	r/min	1200/1100/1000/800
	Fan Motor Power Output	W	10
	Fan Motor RLA	A	0.15
	Fan Motor Capacitor	μF	1
	Evaporator Form		Aluminum Fin-copper Tube
	Evaporator Pipe Diameter	mm	Φ5
	Evaporator Row-fin Gap	mm	2-1.4
	Evaporator Coil Length (LXD _X W)	mm	510×22.8×266.7
	Swing Motor Model		MP24AA
	Swing Motor Power Output	W	1.5
	Fuse Current	A	3.15
	Sound Pressure Level	dB (A)	Cooling:40/38/33/27 Heating:38/35/33/28
	Sound Power Level	dB (A)	Cooling:54/51/46/38 Heating:48/45/43/38
	Dimension (WXHXD)	mm	713X270X195
	Dimension of Carton Box (LXWXH)	mm	760X334X259
	Dimension of Package (LXWXH)	mm	763X350X270
Net Weight	kg	8.1	
Gross Weight	kg	9.6	

Outdoor Unit	Outdoor Unit Model		GWH09AGA-K6DNA1C/O
	Outdoor Unit Product Code		CB385W05100
	Compressor Manufacturer		ZHUHAI LANDA COMPRESSOR CO., LTD
	Compressor Model		QXF-N075zC170
	Compressor Oil		FW68DA or equivalent
	Compressor Type		Rotary
	Compressor LRA.	A	/
	Compressor RLA	A	3
	Compressor Power Input	W	633
	Compressor Overload Protector		/
	Throttling Method		Capillary
	Set Temperature Range	°C	16~30
	Cooling Operation Ambient Temperature Range	°C	-15~43
	Heating Operation Ambient Temperature Range	°C	-15~24
	Condenser Form		Aluminum Fin-copper Tube
	Condenser Pipe Diameter	mm	Φ7.94
	Condenser Rows-fin Gap	mm	1-1.2
	Condenser Coil Length (LXDXW)	mm	635×19.05×418
	Fan Motor Speed	rpm	940±20
	Fan Motor Power Output	W	20
	Fan Motor RLA	A	0.3
	Fan Motor Capacitor	μF	1.5
	Outdoor Unit Air Flow Volume	m ³ /h	1400
	Fan Type		Axial-flow
	Fan Diameter	mm	350
	Defrosting Method		Automatic Defrosting
	Climate Type		T1
	Isolation		I
	Moisture Protection		IPX4
	Permissible Excessive Operating Pressure for the Discharge Side	MPa	4.3
	Permissible Excessive Operating Pressure for the Suction Side	MPa	2.5
	Sound Pressure Level (H/M/L)	dB (A)	51
	Sound Power Level (H/M/L)	dB (A)	61
Dimension(WXHXD)	mm	710X450X293	
Dimension of Carton Box (LXWXH)	mm	761X327X500	
Dimension of Package(LXWXH)	mm	764X330X525	
Net Weight	kg	21	
Gross Weight	kg	23	
Refrigerant		R32	
Refrigerant Charge	kg	0.5	
Connection Pipe	Connection Pipe Length	m	5
	Connection Pipe Gas Additional Charge	g/m	16
	Outer Diameter Liquid Pipe		1/4"
	Outer Diameter Gas Pipe		3/8"
	Max Distance Height	m	10
	Max Distance Length	m	15
	Note: The connection pipe applies metric diameter.		

The above data is subject to change without notice. Please refer to the nameplate of the unit.

Model			GWH12QBXB-K6DNB2C GWH12QBXB-K6DNB4C GWH12QBXB-K6DNB6C GWH12QBXB-K6DNC2C GWH12QBXB-K6DNC6C GWH12QBXB-K6DNE2C GWH12QBXB-K6DND8C
Product Code			CB432029900 CB434025300 CB435015500 CB439019700 CB443012000 CB462003300 CB459011600
Power Supply	Rated Voltage	V~	220-240
	Rated Frequency	Hz	50
	Phases		1
Power Supply Mode			Outdoor
Cooling Capacity		W	3500
Heating Capacity		W	3500
Cooling Power Input		W	1083
Heating Power Input		W	918
Cooling Current Input		A	4.97
Heating Current Input		A	4.22
Rated Input		W	1550
Rated Cooling Current		A	6.21
Rated Heating Current		A	6.88
Air Flow Volume		m ³ /h	590/520/480/400/350/320/280
Dehumidifying Volume		L/h	1.4
EER		W/W	3.23
COP		W/W	3.81
SEER		W/W	/
SCOP(Average/WarmerColder)		W/W	/
Application Area		m ²	15-22
Indoor Unit	Model		GWH12QBXB-K6DNB2C/I GWH12QBXB-K6DNB4C/I GWH12QBXB-K6DNB6C/I GWH12QBXB-K6DNC2C/I GWH12QBXB-K6DNC6C/I GWH12QBXB-K6DNE2C/I GWH12QBXB-K6DND8C/I
	Product Code		CB432N29900 CB434N25300 CB435N15500 CB439N19700 CB443N12000 CB462N03300 CB459N11600
	Fan Type		Cross-flow
	Fan Diameter Length(DXL)	mm	Φ98×580
	Cooling Speed	r/min	1350/1200/1120/1050/950/850/750
	Heating Speed	r/min	1350/1200/1130/1050/990/920/850
	Fan Motor Power Output	W	20
	Fan Motor RLA	A	0.22
	Fan Motor Capacitor	μF	1
	Evaporator Form		Aluminum Fin-copper Tube
	Evaporator Pipe Diameter	mm	Φ5
	Evaporator Row-fin Gap	mm	2-1.4
	Evaporator Coil Length (LXDXW)	mm	584×22.8×266.7
	Swing Motor Model		MP24AA
	Swing Motor Power Output	W	1.5
	Fuse Current	A	3.15
	Sound Pressure Level	dB (A)	Cooling:41/37/35/33/30/26/24 Heating:43/39/37/34/33/30/28
	Sound Power Level	dB (A)	Cooling:56/49/47/45/42/38/36 Heating:53/49/47/45/43/40/37
	Dimension (WXHxD)	mm	790X275X200
	Dimension of Carton Box (LXWXH)	mm	850X339X262
Dimension of Package (LXWXH)	mm	852X355X273	
Net Weight	kg	9	
Gross Weight	kg	11	

Outdoor Unit	Outdoor Unit Model		GWH12AGBXB-K6DNA4C/O
	Outdoor Unit Product Code		CB558W02600
	Compressor Manufacturer		ZHUHAI LANDA COMPRESSOR CO., LTD
	Compressor Model		FTz-AN108ACBD
	Compressor Oil		FW68DA or equivalent
	Compressor Type		Rotary
	Compressor LRA.	A	/
	Compressor RLA	A	4.4
	Compressor Power Input	W	/
	Compressor Overload Protector		/
	Throttling Method		Capillary
	Set Temperature Range	°C	16~30
	Cooling Operation Ambient Temperature Range	°C	-15~43
	Heating Operation Ambient Temperature Range	°C	-15~24
	Condenser Form		Aluminum Fin-copper Tube
	Condenser Pipe Diameter	mm	Φ7
	Condenser Rows-fin Gap	mm	1-1.2
	Condenser Coil Length (LXDXW)	mm	677×19.05×528
	Fan Motor Speed	rpm	900
	Fan Motor Power Output	W	28
	Fan Motor RLA	A	0.35
	Fan Motor Capacitor	μF	2.5
	Outdoor Unit Air Flow Volume	m ³ /h	1950
	Fan Type		Axial-flow
	Fan Diameter	mm	400
	Defrosting Method		Automatic Defrosting
	Climate Type		T1
	Isolation		I
	Moisture Protection		IPX4
	Permissible Excessive Operating Pressure for the Discharge Side	MPa	4.3
	Permissible Excessive Operating Pressure for the Suction Side	MPa	2.5
	Sound Pressure Level (H/M/L)	dB (A)	52
Sound Power Level (H/M/L)	dB (A)	64	
Dimension(WXHXD)	mm	732X555X330	
Dimension of Carton Box (LXWXH)	mm	791X373X590	
Dimension of Package(LXWXH)	mm	794X376X615	
Net Weight	kg	25.5	
Gross Weight	kg	28	
Refrigerant		R32	
Refrigerant Charge	kg	0.39	
Connection Pipe	Connection Pipe Length	m	5
	Connection Pipe Gas Additional Charge	g/m	16
	Outer Diameter Liquid Pipe		1/4"
	Outer Diameter Gas Pipe		3/8"
	Max Distance Height	m	10
	Max Distance Length	m	15
	Note: The connection pipe applies metric diameter.		

The above data is subject to change without notice. Please refer to the nameplate of the unit.

Model			GWH24QDXE-K6DNB6A GWH24QDXE-K6DNB2A GWH24QDXE-K6DNB4A GWH24QDXE-K6DNC2A GWH24QDXE-K6DNC6A GWH24QDXE-K6DNE2A GWH24QDXE-K6DND8A
Product Code			CB435015700 CB432029700 CB434025100 CB439019500 CB443011900 CB462003100 CB459011700
Power Supply	Rated Voltage	V~	220-240
	Rated Frequency	Hz	50
	Phases		1
Power Supply Mode			Outdoor
Cooling Capacity		W	6155
Heating Capacity		W	6200
Cooling Power Input		W	1917
Heating Power Input		W	1698
Cooling Current Input		A	8.89
Heating Current Input		A	7.88
Rated Input		W	2300
Rated Cooling Current		A	11.5
Rated Heating Current		A	/
Air Flow Volume		m ³ /h	900/800/700/650/600/550/500
Dehumidifying Volume		L/h	1.8
EER		W/W	3.21
COP		W/W	3.65
SEER		W/W	/
SCOP(Average/WarmerColder)		W/W	/
Application Area		m ²	23-34
Indoor Unit	Model		GWH24QDXE-K6DNB6A/I GWH24QDXE-K6DNB2A/I GWH24QDXE-K6DNB4A/I GWH24QDXE-K6DNC2A/I GWH24QDXE-K6DNC6A/I GWH24QDXE-K6DNE2A/I GWH24QDXE-K6DND8A/I
	Product Code		CB435N15700 CB432N29700 CB434N25100 CB439N19500 CB443N11900 CB462N03100 CB459N11700
	Fan Type		Cross-flow
	Fan Diameter Length(DXL)	mm	Φ106×706
	Cooling Speed	r/min	1400/1300/1200 /1100/1000/900/800
	Heating Speed	r/min	1400/1270/1200/1130/1050/980/900
	Fan Motor Power Output	W	45
	Fan Motor RLA	A	0.24
	Fan Motor Capacitor	μF	/
	Evaporator Form		Aluminum Fin-copper Tube
	Evaporator Pipe Diameter	mm	Φ7
	Evaporator Row-fin Gap	mm	2-1.4
	Evaporator Coil Length (LXDXW)	mm	715×25.4×304.8
	Swing Motor Model		MP35CP
	Swing Motor Power Output	W	2.5
	Fuse Current	A	3.15
	Sound Pressure Level	dB (A)	Cooling:49/46/43/41/38/34/31 Heating:49/46/44/42/39/37/35
	Sound Power Level	dB (A)	Cooling:58/56/53/51/48/44/41 Heating:58/56/54/52/49/47/45
	Dimension (WXHxD)	mm	970X300X224
	Dimension of Carton Box (LXWXH)	mm	1020X370X294
Dimension of Package (LXWXH)	mm	1025X378X304	
Net Weight	kg	12.7	
Gross Weight	kg	15.2	

Outdoor Unit	Outdoor Unit Model		GWH24QDXE-K6DNB6A/O
	Outdoor Unit Product Code		CB435W15700
	Compressor Manufacturer		ZHUHAI LANDA COMPRESSOR CO. LTD.
	Compressor Model		FTz-SM151AXB
	Compressor Oil		FW68DA
	Compressor Type		Rotary
	Compressor LRA.	A	/
	Compressor RLA	A	6.06
	Compressor Power Input	W	1330
	Compressor Overload Protector		/
	Throttling Method		Capillary
	Set Temperature Range	°C	16~30
	Cooling Operation Ambient Temperature Range	°C	-15~43
	Heating Operation Ambient Temperature Range	°C	-15~24
	Condenser Form		Aluminum Fin-copper Tube
	Condenser Pipe Diameter	mm	Φ7
	Condenser Rows-fin Gap	mm	2-1.4
	Condenser Coil Length (LXDXW)	mm	848x38.1x528
	Fan Motor Speed	rpm	900
	Fan Motor Power Output	W	40
	Fan Motor RLA	A	0.7
	Fan Motor Capacitor	μF	/
	Outdoor Unit Air Flow Volume	m ³ /h	2800
	Fan Type		Axial-flow
	Fan Diameter	mm	Φ445
	Defrosting Method		Automatic Defrosting
	Climate Type		T1
	Isolation		I
	Moisture Protection		IPX4
	Permissible Excessive Operating Pressure for the Discharge Side	MPa	4.3
	Permissible Excessive Operating Pressure for the Suction Side	MPa	2.5
	Sound Pressure Level (H/M/L)	dB (A)	58
Sound Power Level (H/M/L)	dB (A)	67	
Dimension(WXHXD)	mm	873X555X376	
Dimension of Carton Box (LXWXH)	mm	948X428X591	
Dimension of Package(LXWXH)	mm	951X431X620	
Net Weight	kg	35.5	
Gross Weight	kg	38.5	
Refrigerant		R32	
Refrigerant Charge	kg	1	
Connection Pipe	Connection Pipe Length	m	5
	Connection Pipe Gas Additional Charge	g/m	16
	Outer Diameter Liquid Pipe		1/4"
	Outer Diameter Gas Pipe		1/2"
	Max Distance Height	m	10
	Max Distance Length	m	25
Note: The connection pipe applies metric diameter.			

The above data is subject to change without notice. Please refer to the nameplate of the unit.

2.2 Capacity Variation Ratio According to Temperature

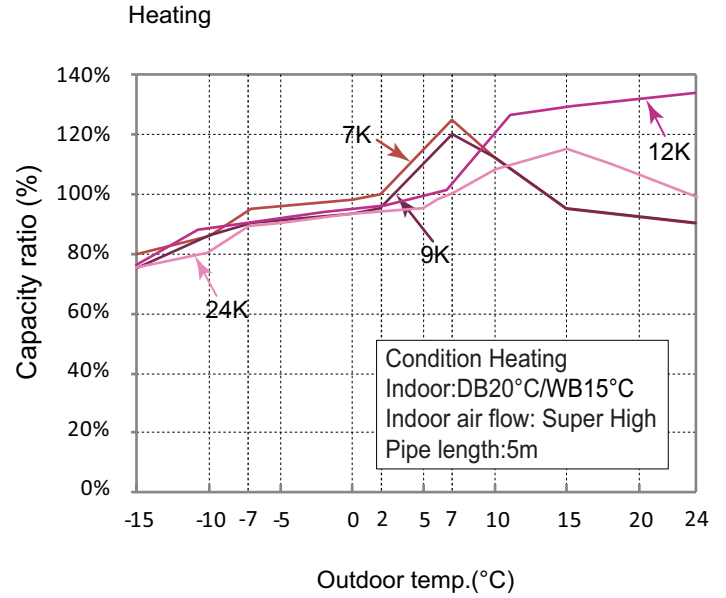
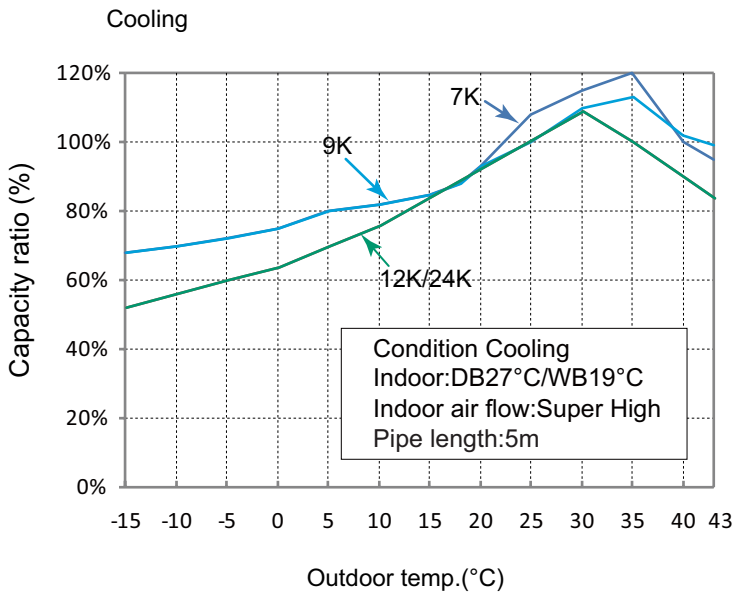

2.3 Cooling and Heating Data Sheet in Rated Frequency

Cooling:

Rated cooling condition(°C) (DB/WB)		Model	Pressure of gas pipe connecting indoor and outdoor unit P (MPa)	Inlet and outlet pipe temperature of heat exchanger		Fan speed of indoor unit	Fan speed of outdoor unit
Indoor	Outdoor			T1 (°C)	T2 (°C)		
27/19	35/24	7K/9K	0.8~1.0	in:8~11 out:11~14	in:75~85 out:37~43	Super High	High
27/19	35/24	12K/24K	0.9~1.1	12 ~ 14	75 ~ 37	Super High	High

Heating:

Rated heating condition(°C) (DB/WB)		Model	Pressure of gas pipe connecting indoor and outdoor unit P (MPa)	Inlet and outlet pipe temperature of heat exchanger		Fan speed of indoor unit	Fan speed of outdoor unit
Indoor	Outdoor			T1 (°C)	T2 (°C)		
20/-	7/6	7K/9K	2.4~2.6	in:55~65 out:30~37	in:1~3 out:2~5	Super High	High
20/-	7/6	12K/24K	2.2~2.4	70 ~ 35	2 ~ 4	Super High	High

Instruction:

T1: Inlet and outlet pipe temperature of evaporator

T2: Inlet and outlet pipe temperature of condenser

P: Pressure at the side of big valve

Connection pipe length: 5 m.

3. Outline Dimension Diagram

3.1 Indoor Unit

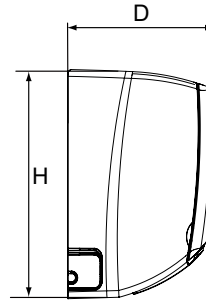
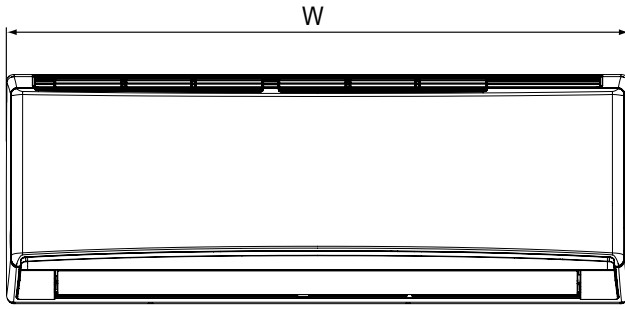

QA/QB

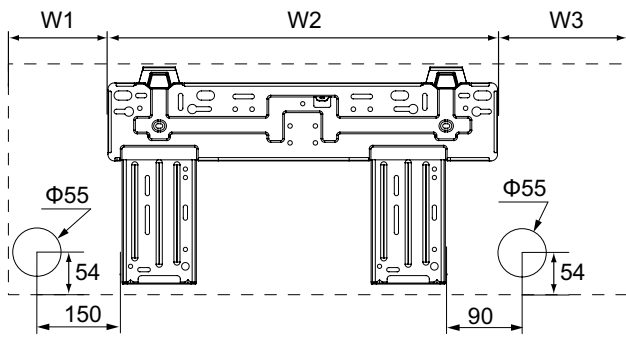

QE

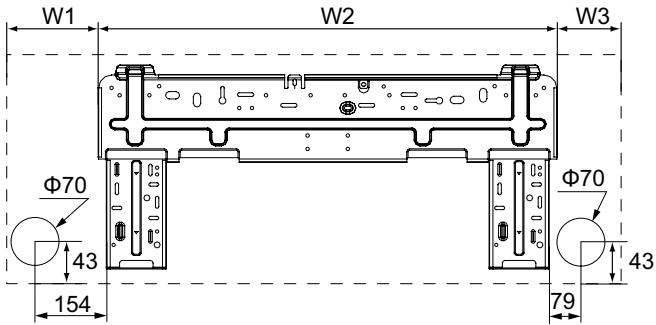

Model	W	H	D	W1	W2	W3
QA	713	270	195	148	462	103
QB	790	275	200	168.5	462	159.5
QE	1078	325	246	206	685	187

* Recommended distance

3.2 Outdoor Unit

7/9K

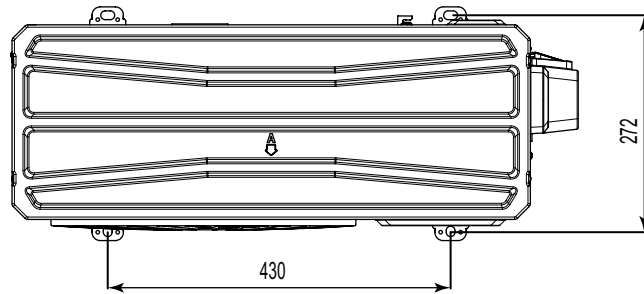
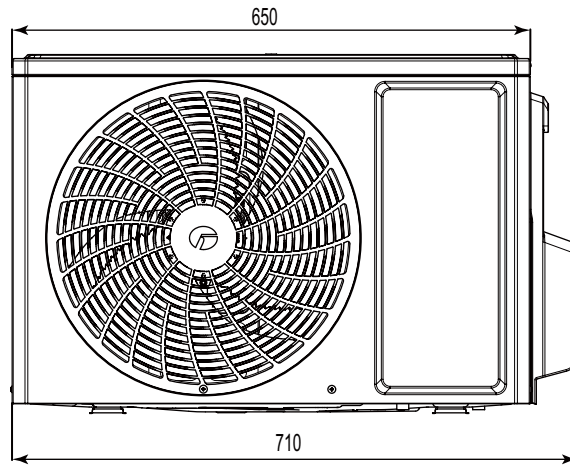
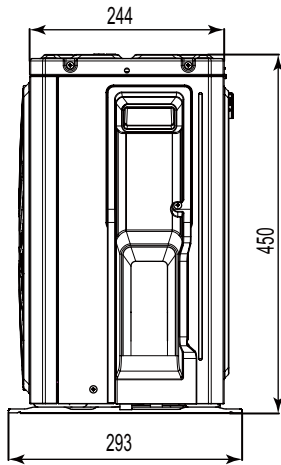

Unit:mm

12K

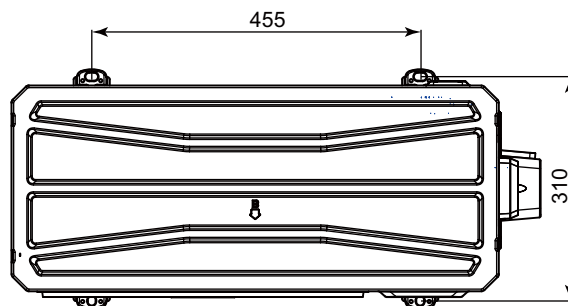
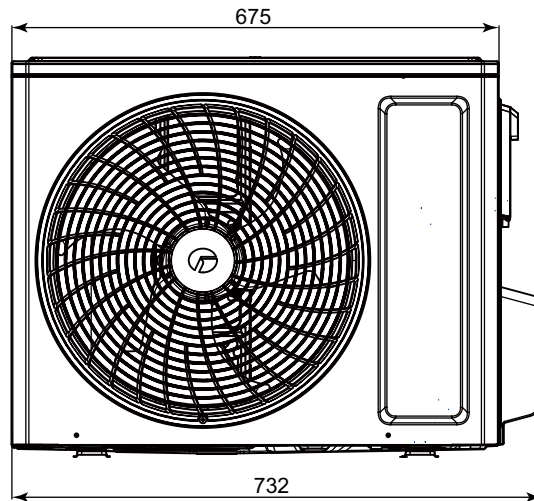
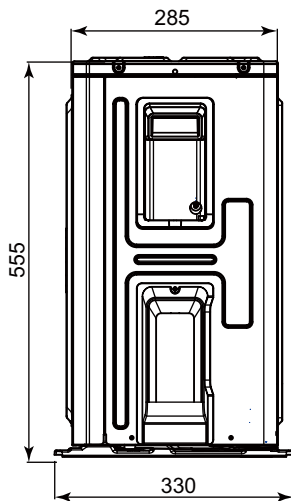

24K

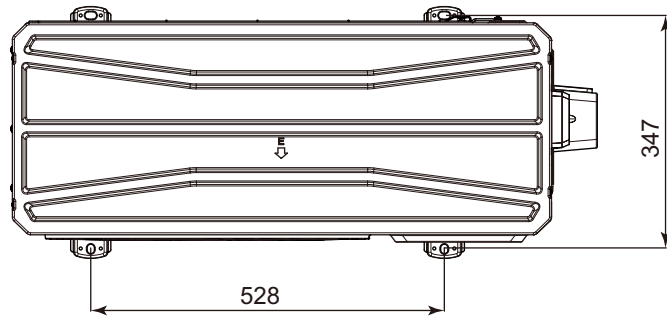
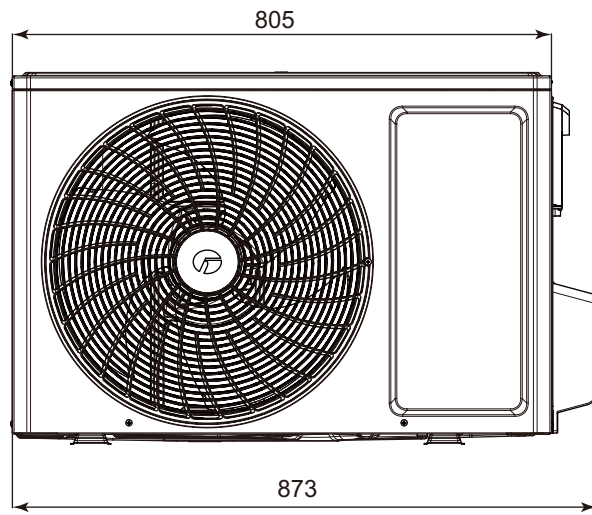
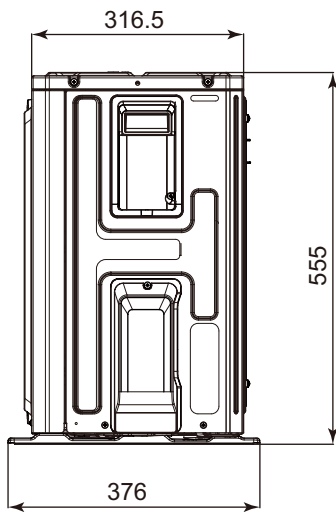

4. Refrigerant System Diagram

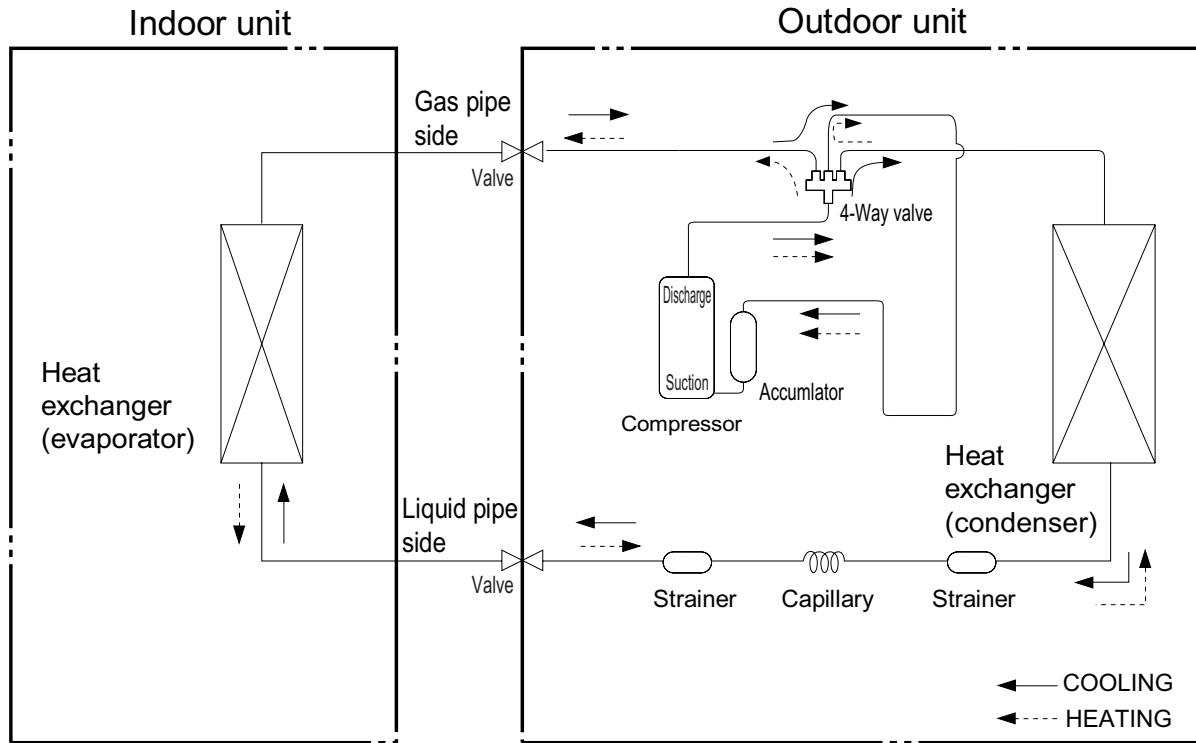

Connection pipe specification:
Liquid pipe: 1/4"
Gas pipe: 3/8" (7~12K) 1/2"(24K)

5. Electrical Part

5.1 Wiring Diagram

•Instruction

Symbol	Symbol Color	Symbol	Symbol Color	Symbol	Name
WH	White	GN	Green	CAP	Jumper cap
YE	Yellow	BN	Brown	COMP	Compressor
RD	Red	BU	Blue		Grounding wire
YEGN	Yellow/Green	BK	Black	/	/
VT	Violet	OG	Orange	/	/

Note: Jumper cap is used to determine fan speed and the swing angle of horizontal lover for this model.

• Indoor Unit

GWH07QA-K6DNB4C/I(CB434N21300) GWH07QA-K6DNA1C/I GWH07QA-K6DNA2C/I GWH07QA-K6DNB6C/I
 GWH07QA-K6DNC4C/I GWH07QA-K6DNC6C/I(CB443N10600) GWH07QA-K6DND6C/I GWH07QA-K6DNE4C/I
 GWH07QA-K6DND8C/I(CB459N09400) GWH07QAXA-K6DNC2C/I(CB439N19300) GWH09QAXA-K6DNB6C/I
 GWH09QAXA-K6DND8C/I(CB459N11300) GWH12QBXB-K6DNB6C/I

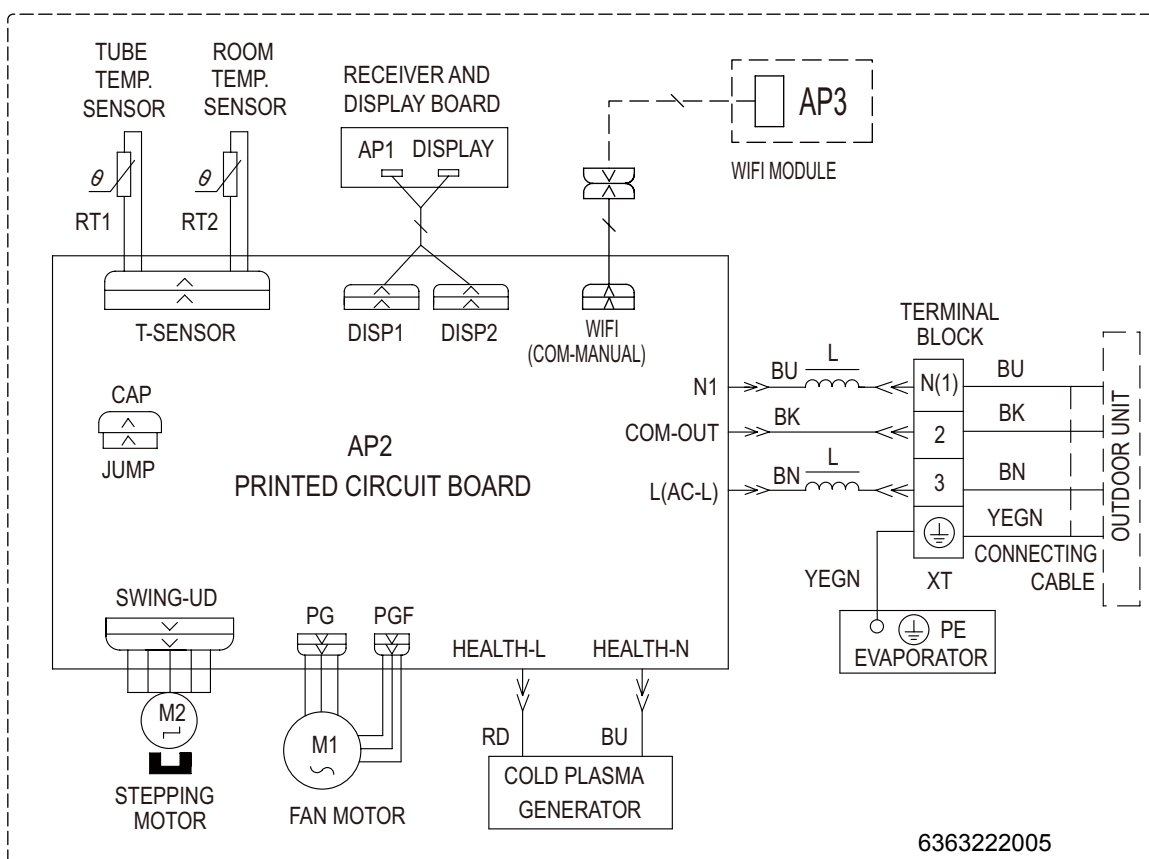

GWH07QA-K6DNB2C/I GWH07QA-K6DNB4C/I(CB434N21301) GWH07QA-K6DNC6C/I(CB443N10601) GWH07QA-K6DND8C/I (CB459N09401) GWH07QAXA-K6DNC2C/I(CB439N19301) GWH07QAXA-K6DNE2C/I GWH07QAXA-K6DNE6C/I GWH09QAXA-K6DNB2C/I GWH09QAXA-K6DNB4C/I GWH09QAXA-K6DNC2C/I GWH09QAXA-K6DNC6C/I GWH09QAXA-K6DNE2C/I GWH09QAXA-K6DND8C/I(CB459N11301) GWH12QBXB-K6DNB2C/I GWH12QBXB-K6DNB4C/I GWH12QBXB-K6DNC2C/I GWH12QBXB-K6DNC6C/I GWH12QBXB-K6DNE2C/I GWH12QBXB-K6DND8C/I

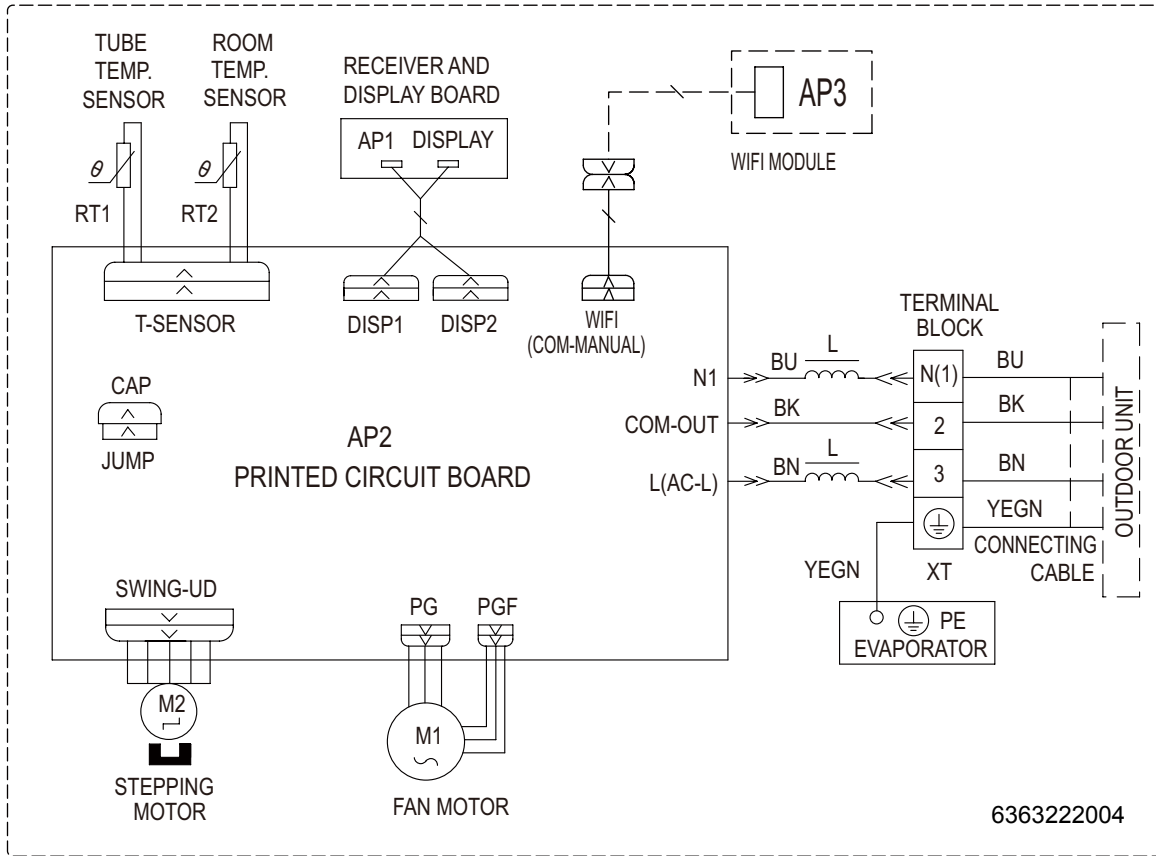

24K

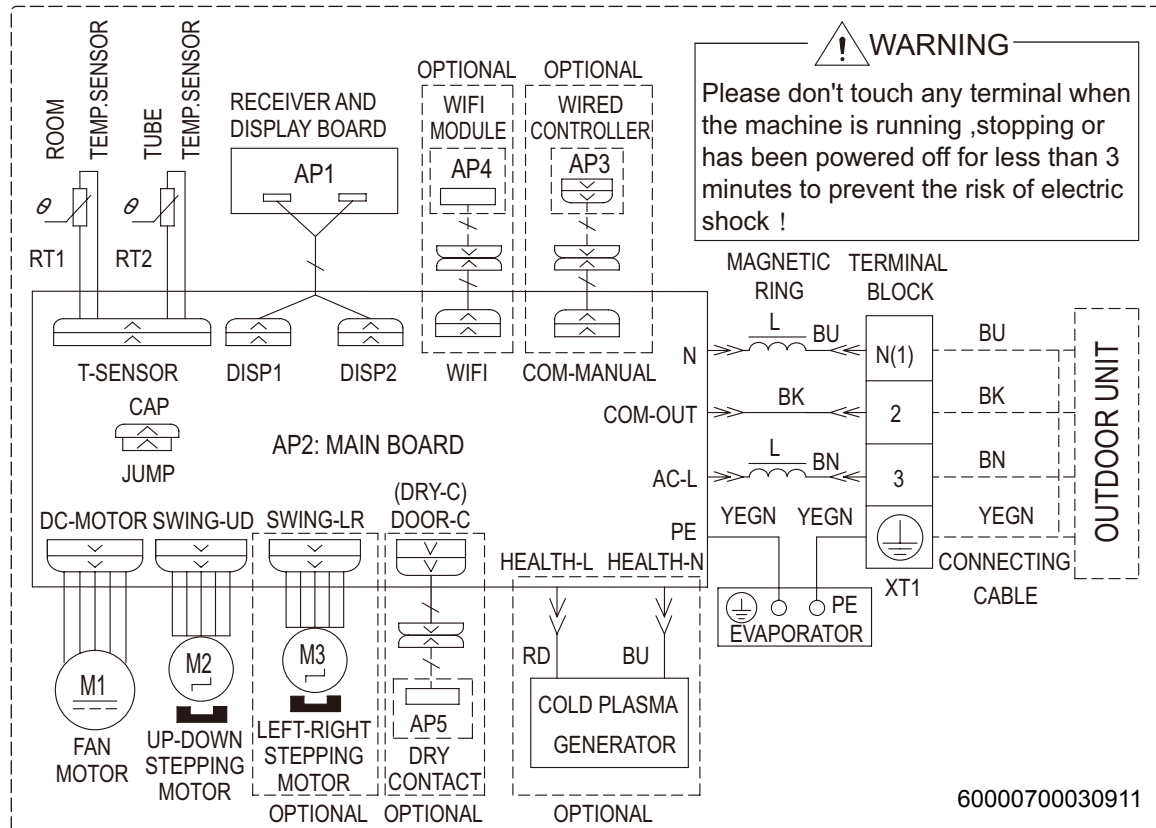

● Outdoor Unit

GWH07AGA-K6DNA1C/O GWH09AGA-K6DNA1C/O

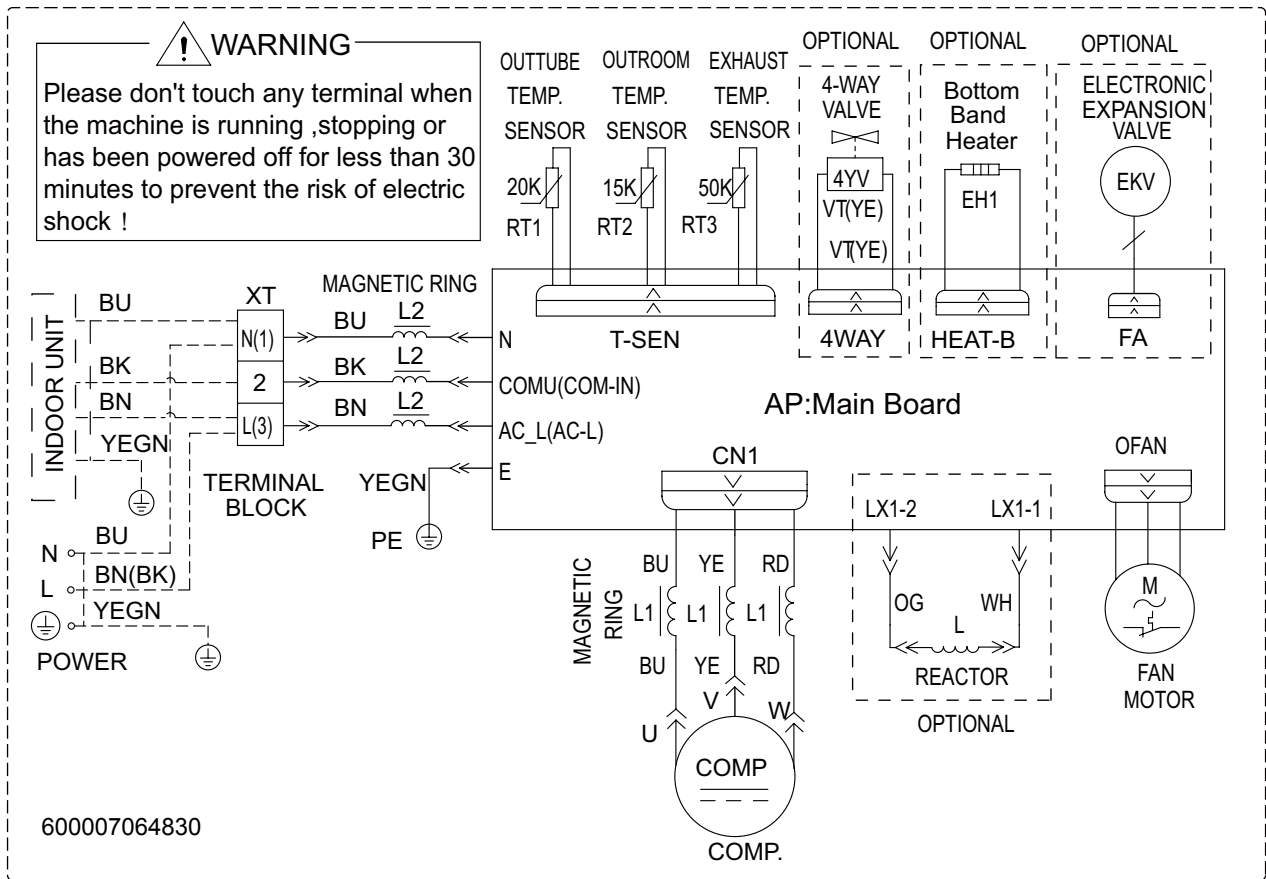

GWH12AGBXB-K6DNA4C/O

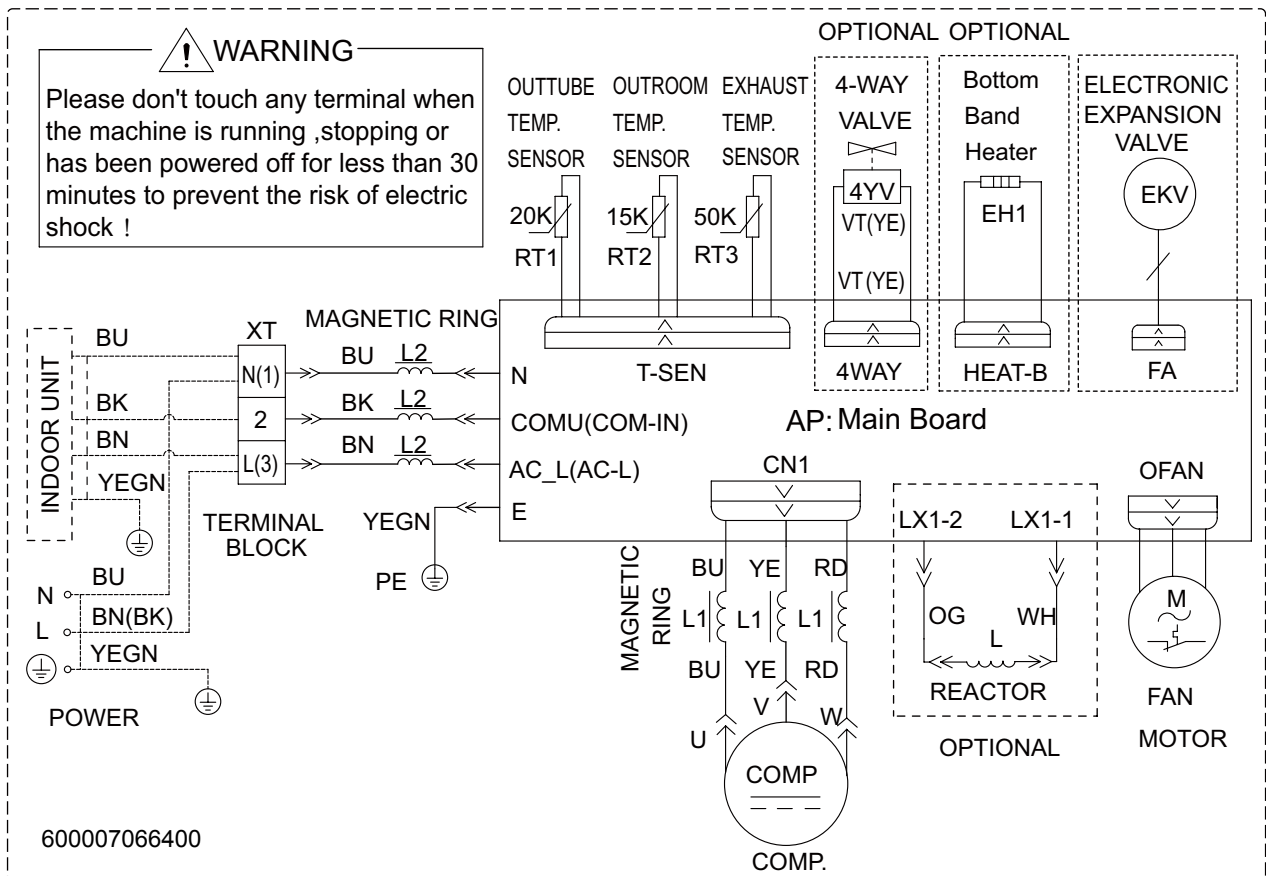

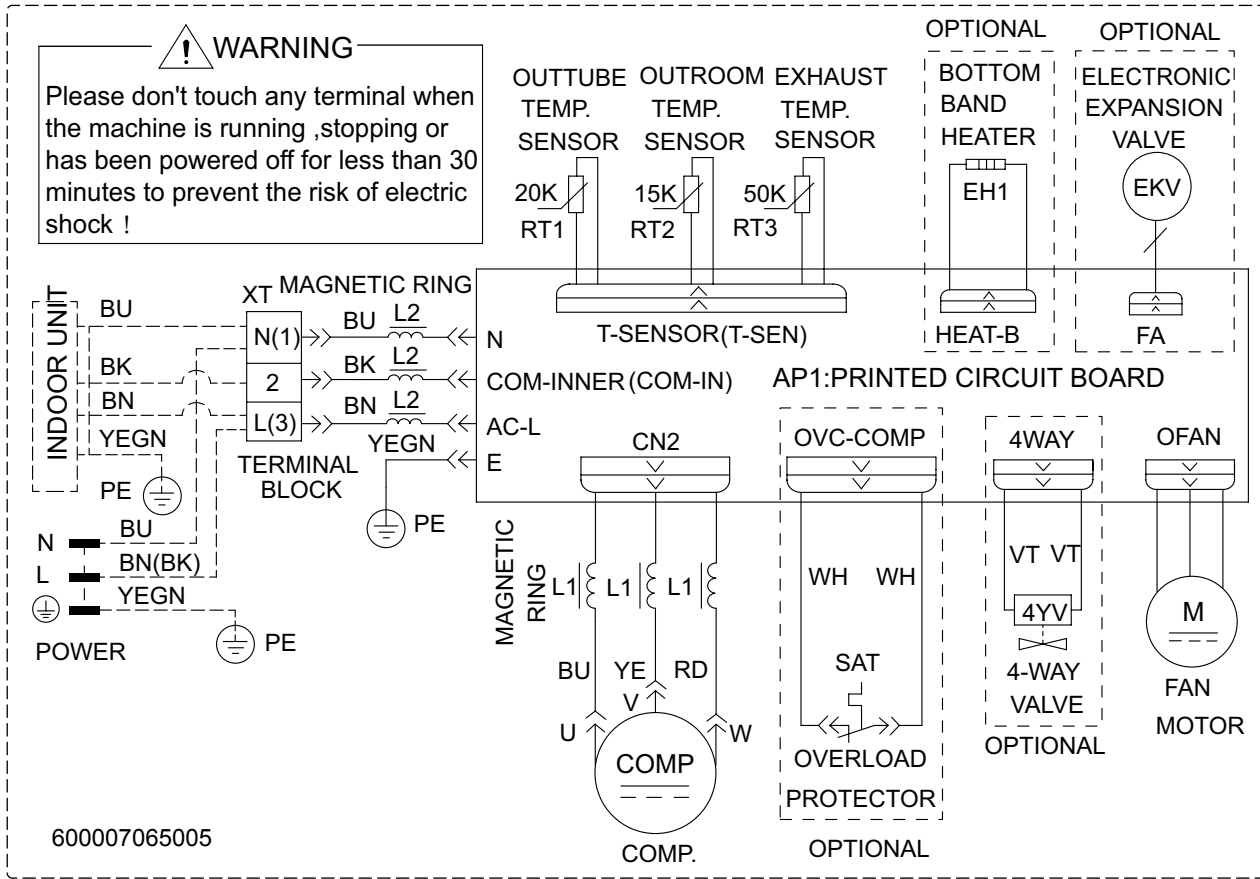

These wiring diagrams are subject to change without notice; please refer to the one supplied with the unit.

5.2 PCB Printed Diagram

Indoor Unit

7K/9K/12K

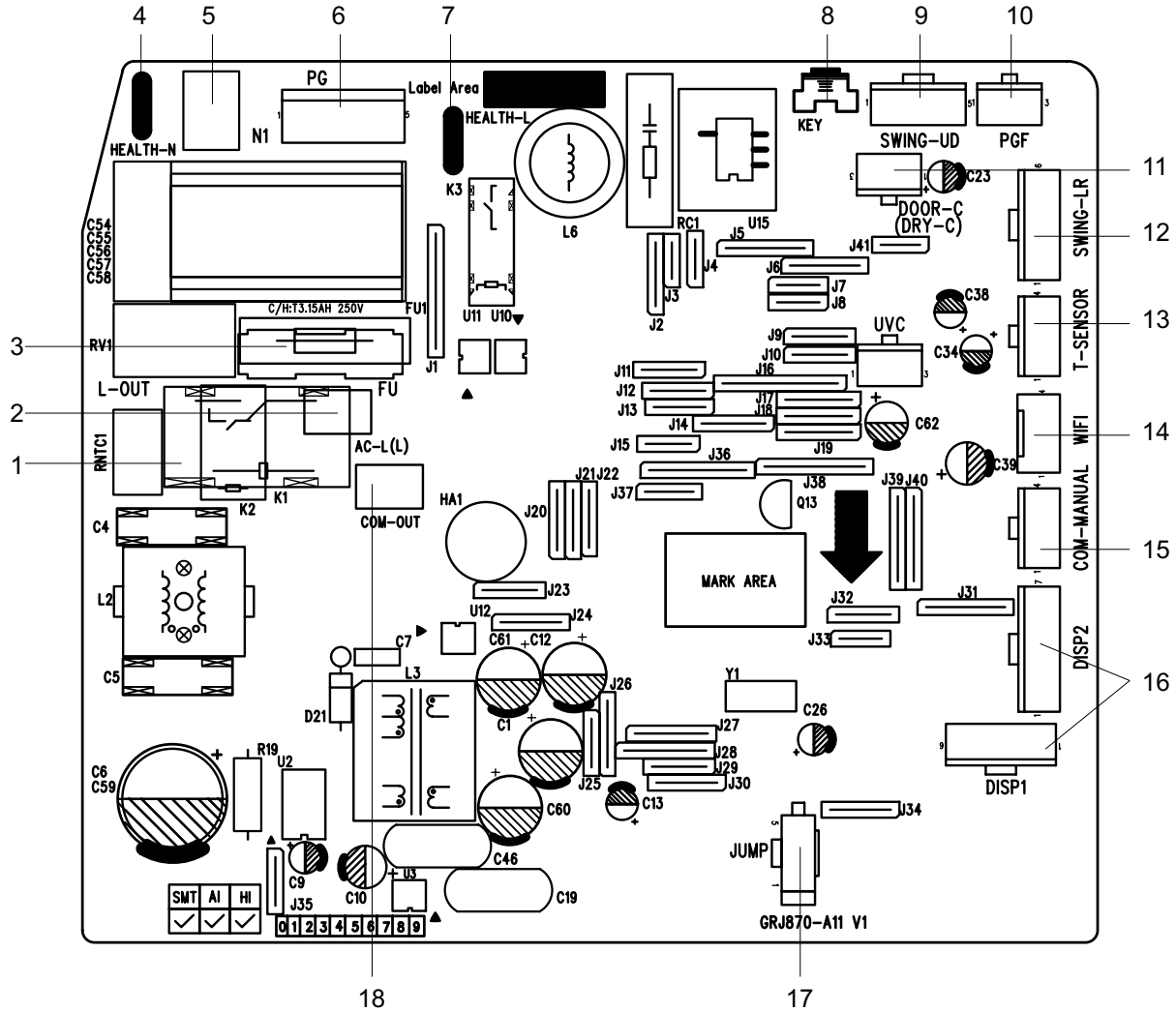

No.	Name
1	Terminal of live wire used for supplying power for outdoor unit
2	Live wire terminal
3	Fuse
4	Interface of health function neutral wire
5	Neutral wire
6	Terminal of fan
7	Interface of health function live wire

No.	Name
10	Interface of PG feedback
11	Interface of gate-control
12	left&right swing interface
13	Interface of temperature sensor
14	Wifi interface
15	Wired controller
16	Display interface
17	Jumper cap
18	Communication terminal for indoor unit and outdoor unit

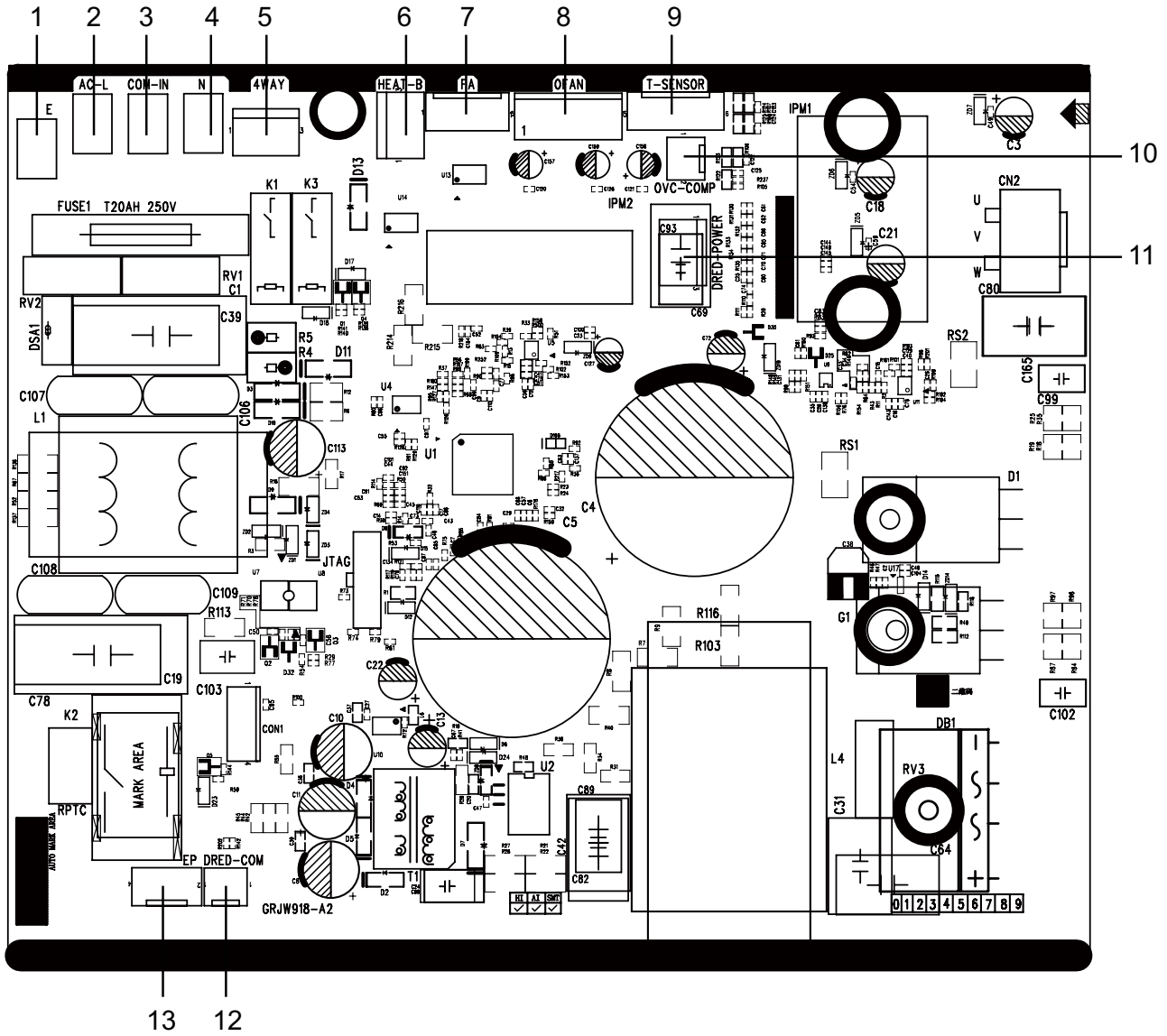

No.	Name	No.	Name
1	Grounding wire	8	Terminal of outdoor fan
2	Live wire	9	Terminal of temperature sensor
3	Communication wire	10	Overload interface of compressor
4	Neutral wire	11	DRED Power supply
5	4-way valve interface	12	DRED Communication
6	Terminal of electric heating for chassis	13	EE flash drive
7	Terminal of electronic expansion valve		

6. Function and Control

6.1 Remote Controller Introduction(YAP1F2)

NOTE:

- This is a general use remote controller. It could be used for the air conditioner with multifunction. For the functions which the model doesn't have, if press the corresponding button on the remote controller, the unit will keep the original running status.
- After putting through the power, the air conditioner will give out a sound. Power indicator "ON" is ON. After that, you can operate the air conditioner by using remote controller.
- Under on status, pressing the button on the remote controller, the signal icon "📶" on the display of remote controller will blink once and the air conditioner will give out a "di" sound, which means the signal has been sent to the air conditioner.
- As for the models with functions of WiFi or wired controller, the indoor unit must have been controlled by standard remote controller under auto mode first, and then the function of adjustable temperature under auto mode can be realized by APP or the wired controller.

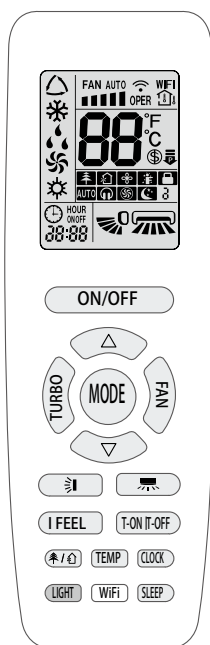

ON/OFF button

Press this button to turn on the unit. Press this button again to turn off the unit.

MODE button

Press this button to select your required operation mode :

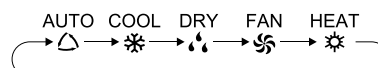

- When selecting auto mode, air conditioner will operate automatically according to the sensed temperature. Set temperature can't be adjusted and will not be displayed as well. Press "FAN" button can adjust fan speed. Press "🌀"/"🌀" button can adjust fan blowing angle.
- After selecting cool mode, air conditioner will operate under cool mode. Press "△" or "▽" button to adjust set temperature. Press "FAN" button to adjust fan speed. Press "🌀"/"🌀" button to adjust fan blowing angle.
- When selecting dry mode, the air conditioner operates at low speed under dry mode. Under dry mode, fan speed can't be adjusted. Press "🌀"/"🌀" button to adjust fan blowing angle.
- When selecting fan mode, the air conditioner will only blow fan, no cooling and no heating. Press "FAN" button to adjust fan speed. Press "🌀"/"🌀" button to adjust fan blowing angle.
- When selecting heating mode, the air conditioner operates under heat mode. Press "△" or "▽" button to adjust set temperature. Press "FAN" button to adjust fan speed. Press "🌀"/"🌀" button to adjust fan blowing angle. (Cooling only unit won't receive heating mode signal. If setting heat mode with remote controller, press ON/OFF button can't start up the unit).

NOTE:

- For preventing cold air, after starting up heat mode, indoor unit will delay 1~5 minutes to blow air (Actual delay time depends on indoor ambient temperature).
- Set temperature range from remote controller: 16~30°C(61~86°F). Fan speed: auto, low speed, medium speed, high speed.
- This mode indicator is not available for some models.

FAN button

Pressing this button can set fan speed circularly as: auto (AUTO), low(■), medium(■■), high(■■■).



Introduction for icons on display screen

	Set fan speed
	Send signal
	WiFi function
	Set temp.
	Indoor ambient temp.
	Outdoor ambient temp.
	Auto mode
	Cool mode
	Dry mode
	Fan mode
	Heat mode
	Set temperature
	8°C heating function
	Health mode
	Scavenging function
	X-FAN function
	I feel
	Child lock
	Quiet
	Turbo mode
	Sleep mode
	Clock
ON/OFF	TIMER ON / TIMER OFF
88:88	Set time
	Up & down swing
	Left & right swing
	Power limiting operation

Note:

- Under AUTO speed, air conditioner will select proper fan speed automatically according to factory default setting.
- It's low fan speed under dry mode.
- X-FAN function Hold fan speed button for 2s in cool or dry mode, the icon "☼" is displayed and the indoor fan will continue operation for a few minutes in order to dry the indoor unit even though you have turned off the unit. After energization, X-FAN OFF is defaulted. X-FAN is not available in AUTO, FAN or HEAT mode. This function indicates that moisture on evaporator of indoor unit will be blown after the unit is stopped to avoid mould.
- Having set X-FAN function on: After turning off the unit by pressing ON/OFF button indoor fan will continue running for a few minutes. at low speed. In this period, Hold fan speed button for 2s to stop indoor fan directly.
- Having set X-FAN function off: After turning off the unit by pressing ON/OFF button, the complete unit will be off directly.

TURBO button

Under COOL or HEAT mode, press this button to turn to quick COOL or quick HEAT mode. "⚡" icon is displayed on remote controller. Press this button again to exit turbo function and "⚡" icon will disappear.

If start this function, the unit will run at super-high fan speed to cool or heat quickly so that the ambient temperature approaches the preset temperature as soon as possible.

△/▽ button

- Press "△" or "▽" button once increase or decrease set temperature 1°C (°F). Holding "△" or "▽" button, 2s later, set temperature on remote controller will change quickly. On releasing button after setting is finished, temperature indicator on indoor unit will change accordingly. (Temperature can't be adjusted under auto mode)
- When setting T-ON, T-OFF or CLOCK, press "△" or "▽" button to adjust time. (Refer to CLOCK, TON, T-OFF buttons)

扇形按钮 button

Press this button can select left & right swing angle. Fan blow angle can be selected circularly as below:

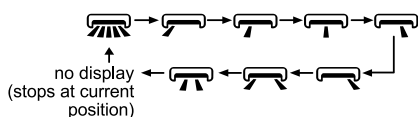

Note:

- Press this button continuously more than 2s, the main unit will swing back and forth from left to right, and then loosen the button, the unit will stop swinging and present position of guide louver will be kept immediately.
- Under left and right swing mode, when the status is switched from off to 扇形按钮, if press this button again 2s later, 扇形按钮 status will switch to off status directly; if press this button again within 2s, the change of swing status will also depend on the circulation sequence stated above.
- The function is only available for some models.

扇形按钮 button

Press this button can select left & right swing angle. Fan blow angle can be selected circularly as below:

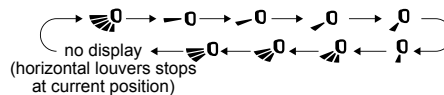

- When selecting "扇形按钮", air conditioner is blowing fan automatically. Horizontal louver will automatically swing up & down at maximum angle.
- When selecting "←○→", air conditioner is blowing fan at fixed position. Horizontal louver will stop at the fixed position.
- When selecting "↙○↘", air conditioner is blowing fan at fixed angle. Horizontal louver will send air at the fixed angle.
- Hold "扇形按钮" above 2s to set your required swing angle. When reaching your required angle, release the button.

Note:

- "↙○↘" may not be available. When air conditioner receives this signal, the air conditioner will blow fan automatically.
- Press this button continuously for more than 2s, the main unit will swing back and forth from up to down, and then loosen the button, the unit present position of guide louver will be kept immediately.
- Under up and down swing mode, when the status is switched from off to 扇形按钮, if press this button again 2s later, 扇形按钮 status will switch to off status directly; if press this button again within 2s, the change of swing status will also depend on the circulation sequence stated above.

T-ON|T-OFF button

- T-ON button

"T-ON" button can set the time for timer on. After pressing this button, "⊕" icon disappears and the word "ON" on remote controller blinks. Press "△" or "▽" button to adjust T-ON setting. After each pressing "△" or "▽" button, T-ON setting will increase or decrease 1min. Hold "△" or "▽" button, 2s later, the time will change quickly until reaching your required time. Press "T-ON" to confirm it. The word "ON" will stop blinking. "⊕" icon resumes displaying. Cancel T-ON: Under the condition that T-ON is started up, press "T-ON" button to cancel it.

- T-OFF button

"T-OFF" button can set the time for timer off. After pressing this button, "⊕" icon disappears and the word "OFF" on remote controller blinks. Press "△" or "▽" button to adjust T-OFF setting. After each pressing "△" or "▽" button, T-OFF setting will increase or decrease 1min. Hold "△" or "▽" button, 2s later, the time will change quickly until reaching your required time. Press "T-OFF" word "OFF" will stop blinking. "⊕" icon resumes displaying. Cancel T-OFF. Under the condition that T-OFF is started up, press "T-OFF" button to cancel it.



Note:

- Under on and off status, you can set T-OFF or T-ON

simultaneously.









- Before setting T-ON or T-OFF, please adjust the clock time.
- After starting up T-ON or T-OFF, set the constant circulating valid. After that, air conditioner will be turned on or turned off according to setting time. ON/OFF button has no effect on setting. If you don't need this function, please use remote controller to cancel it.

I FEEL button

Press this button to start I FEEL function and "  " will be displayed on the remote controller. After this function is set, the remote controller will send the detected ambient temperature to the controller and the unit will automatically adjust the indoor temperature according to the detected temperature. Press this button again to cancel I FEEL function and "  " will disappear.

- Please put the remote controller near user when this function is set. Do not put the remote controller near the object of high temperature or low temperature in order to avoid detecting inaccurate ambient temperature. When I FEEL function is turned on, the remote controller should be put within the area where indoor unit can receive the signal sent by the remote controller.

CLOCK button



Press this button to set clock time. "  " icon on remote controller will blink. Press "  " or "  " button within 5s to set clock time. Each pressing of "  " or "  " button, clock time will increase or decrease 1 minute. If hold "  " or "  " button, 2s later, time will change quickly. Release this button when reaching your required time. Press "CLOCK" button to confirm the time. "  " icon stops blinking.

Note:

- Clock time adopts 24-hour mode.
- The interval between two operation can't exceed 5s. Otherwise, remote controller will quit setting status. Operation for T-ON/T-OFF is the same.

SLEEP button

Under COOL or HEAT mode, press this button to start up sleep function.

"  " icon is displayed on remote controller. Press this button again to cancel sleep function and "  " icon will disappear. After powered on, Sleep Off is defaulted. After the unit is turned off, the Sleep function is canceled.

In this mode, set temperature will be adjusted with the change of time. Under Fan, DRY and Auto modes, this function is not available.

WiFi button





Press " WiFi " button to turn on WiFi function, "WiFi" icon will be displayed on the remote controller; Hold " WiFi " button for 5s to turn off WiFi function and " WiFi " icon will disappear.

Under off status, press "MODE" and " WiFi " buttons simultaneously for 1s, WiFi module will restore factory settings.

Note:



- This function is only available for some models.

button

Press this button to achieve the on and off of health and scavenging functions in operation station. Press this button for the first time to start scavenging function; LCD displays "  ". Press the button for the second time to start health and scavenging functions simultaneously; LCD displays "  " and "  ". Press this button for the third time to quit health and scavenging functions simultaneously. Press the button for the fourth time to start health function; LCD display "  ". Press this button again to repeat the operation above.

- This function is applicable to partial of models .



LIGHT button

Press this button to turn off display light on indoor unit. "  " icon on remote controller disappears. Press this button again to turn on display light. "  " icon is displayed.

TEMP button

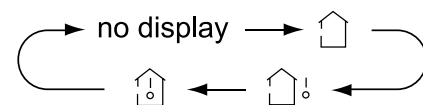
By pressing this button, you can see indoor set temperature, indoor ambient temperature or outdoor ambient temperature on indoor unit's display. The setting on remote controller is selected circularly as below:



- When selecting "  " or no display with remote controller, temperature indicator on indoor unit displays set temperature.
- When selecting "  " with remote controller, temperature indicator on indoor unit displays indoor ambient temperature.
- When selecting "  " with remote controller, temperature indicator on indoor unit displays outdoor ambient temperature.

Note:

- Outdoor temperature display is not available for some models. At that time, indoor unit receives "  " signal, while it displays indoor set temperature.
- It's defaulted to display set temperature when turning on the unit. There is no display in the remote controller.
- Only for the models whose indoor unit has dual-8 display.
- When selecting displaying of indoor or outdoor ambient temperature, indoor temperature indicator displays corresponding temperature and automatically turn to display set temperature after three or five seconds.

Function introduction for combination buttons

Energy-saving function

Under cooling mode, press "TEMP" and "CLOCK" buttons simultaneously to start up or turn off energysaving function. When energy-saving function is started up, "SE" will be shown on remote controller, and air conditioner will adjust the set temperature automatically according to ex-factory setting to reach to the best energy-saving effect. Press "TEMP" and "CLOCK" buttons simultaneously again to exit energysaving function.

Note:

- Under energy-saving function, fan speed is defaulted at auto speed and it can't be adjusted.
- Under energy-saving function, set temperature can't be adjusted. Press "TURBO" button and the remote controller won't send signal.
- Sleep function and energy-saving function can't operate at the same time. If energy-saving function has been set under cooling mode, press "SLEEP" button will cancel energy-saving function. If sleep function has been set under cooling mode, start up the energy-saving function will cancel sleep function.

8°C heating function

Under heat mode, press "TEMP" and "CLOCK" buttons simultaneously to start up or turn off 8°C heating function. When this function is started up, "8°C" will be shown on remote controller, and the air conditioner keep the heating status at 8°C. Press "TEMP" and "CLOCK" buttons simultaneously again to exit 8°C heating function.

Note:

- Under 8°C heating function, fan speed is defaulted at auto speed and it can't be adjusted.
- Under 8°C heating function, set temperature can't be adjusted. Press "TURBO" button and the remote controller won't send signal.
- Sleep function and 8°C heating function can't operate at the same time. If 8°C heating function has been set under heat mode, press sleep button will cancel 8°C heating function. If sleep function has been set under heat mode, start up the 8°C heating function will cancel sleep function.
- Under °F temperature display, the remote controller will display 46°F heating.

Child lock function

Press "△" and "▽" simultaneously to turn on or turn off child lock function. When child lock function is on, "🔒" icon is displayed on remote controller. If you operate the remote controller, the "🔒" icon will blink three times without sending signal to the unit.

Temperature display switchover function

Under OFF status, press "▽" and "MODE" buttons simultaneously to switch temperature display between °C and °F.

Auto clean function

Under unit off status, hold "MODE" and "FAN" buttons

simultaneously for 5s to turn on or turn off the auto clean function. When the auto clean function is turned on, indoor unit displays "CL". During the auto clean process of evaporator, the unit will perform fast cooling or fast heating. There may be some noise, which is the sound of flowing liquid or thermal expansion or cold shrinkage. The air conditioner may blow cool or warm air, which is a normal phenomenon. During cleaning process, please make sure the room is well ventilated to avoid affecting the comfort.

Note:

- The auto clean function can only work under normal ambient temperature. If the room is dusty, clean it once a month; if not, clean it once every three months. After the auto clean function is turned on, you can leave the room. When auto clean is finished, the air conditioner will enter standby status.
- This function is only available for some models.

Replacement of batteries in remote controller

1. Lift the cover along the direction of arrow (as shown in Fig 1 ①).
2. Take out the original batteries (as shown in Fig 1 ②).
3. Place two 7# (AAA 1.5V) dry batteries, and make sure the position of "+" polar and "-" polar is correct (as shown in Fig 2 ③).
4. Reinstall the cover (as shown in Fig 2 ④).

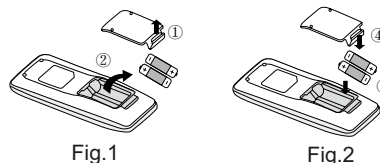

Notice:

- During operation, point the remote control signal sender at the receiving window on indoor unit.
- The distance between signal sender and receiving window should be no more than 8m, and there should be no obstacles between them.
- Signal may be interfered easily in the room where there is fluorescent lamp or wireless telephone; remote controller should be close to indoor unit during operation.
- Replace new batteries of the same model when replacement is required.
- When you don't use remote controller for a long time, please take out the batteries.
- If the display on remote controller is fuzzy or there's no display, please replace batteries.

6.2 Remote Controller Introduction(YAP1FB2)

Buttons on remote controller

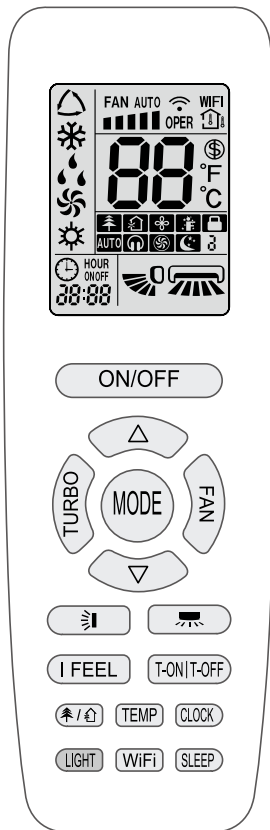

Introduction for icons on display screen

	Set fan speed
	Send signal
	WiFi function
	Set temp.
	Indoor ambient temp.
	Outdoor ambient temp.
Operation mode	Auto mode
	Cool mode
	Dry mode
	Fan mode
	Heat mode
	Set temperature
	8°C heating function
	Health mode
	Scavenging function
	X-FAN function
	I feel
	Child lock
	Quiet
	Turbo mode
	Sleep mode
	Clock
ON/OFF	TIMER ON / TIMER OFF
	Set time
	Up & down swing
	Left & right swing

NOTE:

- This is a general use remote controller. It could be used for the air conditioner with multifunction. For the functions which the model doesn't have, if press the corresponding button on the remote controller, the unit will keep the original running status.
- After putting through the power, the air conditioner will give out a sound. Power indicator "⏻" is ON. After that, you can operate the air conditioner by using remote controller.
- Under on status, pressing the button on the remote controller, the signal icon "📶" on the display of remote controller will blink once and the air conditioner will give out a "di" sound, which means the signal has been sent to the air conditioner.

ON/OFF button

Press this button to turn on the unit. Press this button again to turn off the unit.

MODE button

Press this button to select your required operation mode.

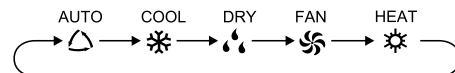

- When selecting auto mode, air conditioner will operate automatically according to ex-factory setting. Set temperature can't be adjusted and will not be displayed as well. Press "FAN" button can adjust fan speed. Press "🌀" / "🌀" button can adjust fan blowing angle.
- After selecting cool mode, air conditioner will operate under cool mode. Press "△" or "▽" button to adjust set temperature. Press "FAN" button to adjust fan speed. Press "🌀" / "🌀" button to adjust fan blowing angle.
- When selecting dry mode, the air conditioner operates at low speed under dry mode. Under dry mode, fan speed can't be adjusted. Press "🌀" / "🌀" button to adjust fan blowing angle.
- When selecting fan mode, the air conditioner will only blow fan, no cooling and no heating. All indicators are OFF. Press "FAN" button to adjust fan speed. Press "🌀" / "🌀" button to adjust fan blowing angle.
- When selecting heat mode, the air conditioner operates under heat mode. Press "△" or "▽" button to adjust set temperature. Press "FAN" button to adjust fan speed. Press "🌀" / "🌀" button to adjust fan blowing angle. (Cooling only unit won't receive heating mode signal. If setting heat mode with remote controller, press ON/OFF button can't start up the unit).

NOTE:

- For preventing cold air, after starting up heat mode, indoor unit will delay 1~5 minutes to blow air (Actual delay time depends on indoor ambient temperature).
- Set temperature range from remote controller: 16~30°C(61-86°F).
- Fan speed: auto, low speed, medium speed, high speed.
- This indicator is not available for some models.

FAN button

Pressing this button can set fan speed circularly as: auto (AUTO), low(■), medium(■■), high(■■■).

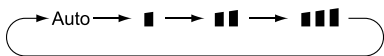

NOTE:

- Under AUTO speed, air conditioner will select proper fan speed automatically according to ex-factory setting.
- It's low fan speed under Dry mode.
- X-FAN function Hold fan speed button for 2s in COOL or DRYmode, the icon "⊗" is displayed and the indoor fan will continue operation for a few minutes in order to dry the indoor unit even though you have turned off the unit. After energization, X-FAN OFF is defaulted. X-FAN is not available in AUTO, FAN or HEAT mode. This function indicates that moisture on evaporator of indoor unit will be blown after the unit is stopped to avoid mould.
- Having set X-FAN function on: After turning off the unit by pressing ON/OFF button indoor fan will continue running for a few minutes. at low speed. In this period, Hold fan speed button for 2s to stop indoor fan directly.
- Having set X-FAN function off: After turning off the unit by pressing ON/OFF button, the complete unit will be off directly.

TURBO button

Under COOL or HEAT mode, press this button to turn to quick COOL or quick HEAT mode. "⊗" icon is displayed on remote controller. Press this button again to exit turbo function and "⊗" icon will disappear. If start this function, the unit will run at super-high fan speed to cool or heat quickly so that the ambient temperature approaches the preset temperature as soon as possible.

△ button

Press "△" or "▽" button once increase or decrease set temperature 1°C(°F). Holding "△" or "▽" button, 2s later, set temperature on remote controller will change quickly. On releasing button after setting is finished, temperature indicator on indoor unit will change accordingly. (Temperature can't be adjusted under auto mode)

When setting T-ON, T-OFF or CLOCK, press "△" or "▽" button to adjust time. (Refer to CLOCK, T-ON, T-OFF buttons).

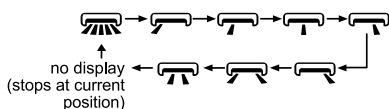

button

Press this button can select left & right swing angle. Fan blow angle can be selected circularly as below:



NOTE:

- Press this button continuously more than 2s, the main unit will swing back and forth from left to right, and then loosen the button, the unit will stop swinging and present position of guide louver will be kept immediately.
- Under swing left and right mode, when the status is switched









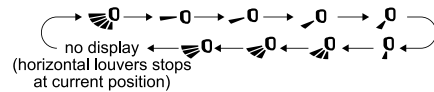

from off to , if press this button again 2s later,  status will switch to off status directly; if press this button again within 2s, the change of swing status will also depend on the circulation sequence stated above.

- The function is only available for some models.





button

Press this button can select up & down swing angle. Fan blow angle can be selected circularly as below:



- When selecting "", air conditioner is blowing fan automatically. Horizontal louver will automatically swing up & down at maximum angle.
- When selecting ", , , , ", air conditioner is blowing fan at fixed position. Horizontal louver will stop at the fixed position.
- When selecting ", , ", air conditioner is blowing fan at fixed angle.
- Hold "" button above 2s to set your required swing angle. When reaching your required angle, release the button.

NOTE:

- ", , " may not be available. When air conditioner receives this signal, the air conditioner will blow fan automatically.
- Press this button continuously for more than 2s, the main unit will swing back and forth from up to down, and then loosen the button, the unit will stop swinging and present position of guide louver will be kept immediately.
- Under swing up and down mode, when the status is switched from off to , if press this button again 2s later,  status will switch to off status directly; if press this button again within 2s, the change of swing status will also depend on the circulation sequence stated above.

T-ON|T-OFF button

- T-ON button
"T-ON" button can set the time for timer on. After pressing this button, "⌚" icon disappears and the word "ON" on remote controller blinks. Press "△" or "▽" button to adjust T-ON setting. After each pressing "△" or "▽" button. T-ON setting will increase or decrease 1min. Holding "△" or "▽" button, 2s later, the time will change quickly until reaching your required time. Press "T-ON" to confirm it. The word "ON" will stop blinking. "⌚" icon resumes displaying. Cancel T-ON: Under the condition that T-ON is started up, press "T-ON" button to cancel it.
- T-OFF button
"T-OFF" button can set the time for timer off. After pressing this

button, "🕒" icon disappears and the word "OFF" on remote controller blinks. Press "△" or "▽" button to adjust T-OFF setting. After each pressing "△" or "▽" button, T-OFF setting will increase or decrease 1min. Holding "△" or "▽" button, 2s later, the time will change quickly until reaching your required time. Press "T-OFF" and the word "OFF" will stop blinking. "🕒" icon resumes displaying. Cancel T-OFF: Under the condition that T-OFF is started up, press "T-OFF" button to cancel it.

NOTE:

- Under on and off status, you can set T-OFF or T-ON simultaneously.
 - Before setting T-OFF or T-ON, please adjust the clock time.
 - After starting up T-ON or T-OFF, set the constant circulating valid. After that, air conditioner will be turned on or turned off according to setting time.
- ON/OFF button has no effect on setting. If you don't need this function, please use remote controller to cancel it.

I FEEL button

Press this button to start I FEEL function and "🌡️" will be displayed on the remote controller. After this function is set, the remote controller will send the detected ambient temperature to the controller and the unit will automatically adjust the indoor temperature according to the detected temperature. Press this button again to close I FEEL function and "🌡️" will disappear.

- Please put the remote controller near user when this function is set. Do not put the remote controller near the object of high temperature or low temperature in order to avoid detecting inaccurate ambient temperature. When I FEEL function is turned on, the remote controller should be put within the area where indoor unit can receive the signal sent by the remote controller.

CLOCK button

Press this button to set clock time. "🕒" icon on remote controller will blink. Press "△" or "▽" button within 5s to set clock time. Each pressing of "△" or "▽" button, clock time will increase or decrease 1 minute. If hold "△" or "▽" button, 2s later, time will change quickly. Release this button when reaching your required time. Press "CLOCK" button to confirm the time. "🕒" icon stops blinking.

NOTE:

- Clock time adopts 24-hour mode.
- The interval between two operations can't exceed 5s. Otherwise, remote controller will quit setting status. Operation for T-ON/T-OFF is the same.

SLEEP button

Under COOL or HEAT mode, press this button to start up sleep function.

"🌙" icon is displayed on remote controller. Press this button again to cancel sleep function and "🌙" icon will disappear. After powered on, Sleep Off is defaulted. After the unit is turned off, the Sleep function is canceled.

In this mode, set temperature will be adjusted with the change

of time. Under Fan, DRY and Auto modes, this function is not available.

WiFi button

Press "WiFi" button to turn on WiFi function, "WiFi" icon will be displayed on the remote controller;

Hold "WiFi" button for 5s to turn off WiFi function and "WiFi" icon will disappear.

Under off status, press "MODE" and "WiFi" buttons simultaneously for 1s, WiFi module will restore factory settings.

NOTE:

- This function is only available for some models.

🏠/🌿 button

Press this button to turn on or turn off the health and scavenging functions in operation status. Press this button for the first time to start scavenging function; LCD displays "🏠". Press the button for the second time to start health and scavenging functions simultaneously; LCD displays "🏠" and "🌿".

Press this button for the third time to quit health and scavenging functions simultaneously. Press the button for the fourth time to start health function; LCD display "🌿". Press this button again to repeat the operation above.

NOTE:

- This function is only available for some models.

LIGHT button

Press this button to turn off display light on indoor unit. "💡" icon on remote controller disappears.

Press this button again to turn on display light. "💡" icon is displayed.

TEMP button

By pressing this button, you can see indoor set temperature, indoor ambient temperature or outdoor ambient temperature on indoor unit's display. The setting on remote controller is selected circularly as below:



- When selecting "🏠" or no display with remote controller, temperature indicator on indoor unit displays set temperature.
- When selecting "🏠🌡️" with remote controller, temperature indicator on indoor unit displays indoor ambient temperature.
- When selecting "🏠🌡️☁️" with remote controller, temperature indicator on indoor unit displays outdoor ambient temperature.

NOTE:

- Outdoor temperature display is not available for some models. At that time, indoor unit receives "🏠☁️" signal, while it displays indoor set temperature.

- It's defaulted to display set temperature when turning on the unit. There is no display in the remote controller.
- Only for the models whose indoor unit has dual-8 display.
- When selecting displaying of indoor or outdoor ambient temperature, indoor temperature indicator displays corresponding temperature and automatically turn to display set temperature after three or five seconds.

Function introduction for combination buttons

Energy-saving function

Under cooling mode, press "TEMP" and "CLOCK" buttons simultaneously to start up or turn off energy-saving function. When energy-saving function is started up, "SE" will be shown on remote controller, and air conditioner will adjust the set temperature automatically according to ex-factory setting to reach to the best energy-saving effect. Press "TEMP" and "CLOCK" buttons simultaneously again to exit energy-saving function.

NOTE:

- Under energy-saving function, fan speed is defaulted at auto speed and it can't be adjusted.
- Under energy-saving function, set temperature can't be adjusted. Press "TURBO" button and the remote controller won't send signal.
- Sleep function and energy-saving function can't operate at the same time. If energy-saving function has been set under cool mode, press "SLEEP" button will cancel energy-saving function. If sleep function has been set under cool mode, start up the energy-saving function will cancel sleep function.

8°C heating function

Under heat mode, press "TEMP" and "CLOCK" buttons simultaneously to start up or turn off 8°C heating function. When this function is started up, "⊕" and "8°C" will be shown on remote controller, and the air conditioner keep the heating status at 8°C. Press "TEMP" and "CLOCK" buttons simultaneously again to exit 8°C heating function.

NOTE:

- Under 8°C heating function, fan speed is defaulted at auto speed and it can't be adjusted.
- Under 8°C heating function, set temperature can't be adjusted. Press "TURBO" button and the remote controller won't send signal.
- Sleep function and 8°C heating function can't operate at the same time. If 8°C heating function has been set under heat mode, press "SLEEP" button will cancel 8 °C heating function. If sleep function has been set under heat mode, start up the 8°C heating function will cancel sleep function.
- Under °F temperature display, the remote controller will display 46°F heating.

Child lock function

Press "△" and "▽" simultaneously to turn on or turn off child lock function. When child lock function is on, "🔒" icon is displayed on remote controller. If you operate the remote controller, the "🔒" icon will blink three times without sending signal to the unit.

Temperature display switchover function

Under OFF status, press "▽" and "MODE" buttons simultaneously to switch temperature display between °C and °F.

Auto clean function

Under unit off status, hold "MODE" and "FAN" buttons simultaneously for 5s to turn on or turn off the internal clean function. When the internal clean function is turned on, indoor unit displays "CL".

During the self-cleaning process of evaporator, the unit will perform fast cooling or fast heating. There may be some noise, which is the sound of flowing liquid or thermal expansion or cold shrinkage. The air conditioner may blow cool or warm air, which is a normal phenomenon. During cleaning, please make sure the room is well ventilated to avoid affecting the degree of comfort.

NOTE:

- The auto clean function can only work under normal ambient temperature. If the room is dusty, clean it once a month; if not, clean it once every three months. After the auto clean function is turned on, you can leave the room. When auto clean is finished, the air conditioner will enter standby status.
- This function is only available for some models.

Replacement of batteries in remote controller

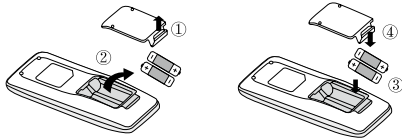

Fig 1

Fig 2

1. Lift the cover along the direction of arrow (as shown in Fig 1 ①).
2. Take out the original batteries (as shown in Fig 1 ②).
3. Place two 7# (AAA 1.5V) dry batteries, and make sure the position of “+” polar and “-” polar is correct (as shown in Fig 2 ③).
4. Reinstall the cover (as shown in Fig 2 ④).

NOTICE:

- During operation, point the remote control signal sender at the receiving window on indoor unit.
- The distance between signal sender and receiving window should be no more than 8m, and there should be no obstacles between them.
- Signal may be interfered easily in the room where there is fluorescent lamp or wireless telephone; remote controller should be close to indoor unit during operation.
- Replace new batteries of the same model when replacement is required.
- When you don't use remote controller for a long time, please take out the batteries.
- If the display on remote controller is fuzzy or there's no display, please replace batteries.

6.3 Remote Controller Introduction (YAW1F10)

Notice:

- 1.This is a general use remote controller. It could be used for the air conditioner with multifunction. For the functions which the model doesn't have, if press the corresponding button on the remote controller, the unit will keep the original running status.
- 2.After putting through the power, the air conditioner will give out a sound. Operation indicator " ⏻ " is ON (red indicator, the colour is different for different models). After that, you can operate the air conditioner by using remote controller.
- 3.Under on status, pressing the button on the remote controller, the signal icon " 📶 " on the display of remote controller will blink once and the air conditioner will give out a " di " sound, which means the signal has been sent to the air conditioner.
- 4.As for the models with functions of WiFi or wired controller, the indoor unit must has been controlled by standard remote controller under auto mode first, and then the function of adjustable temperature under auto mode can be realized by APP or the wired controller.

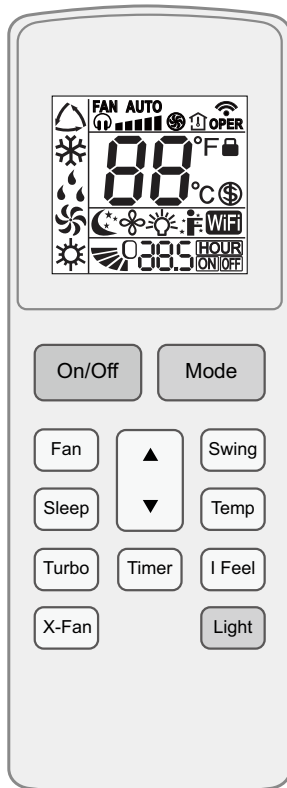

On/Off button

Press this button to turn on the unit. Press this button again to turn off the unit.

Mode button

Each time you press this button, a mode is selected in a sequence that goes from AUTO, COOL, DRY, FAN, and HEAT *, as the following:



*Note: Only for models with heating function.

Fan button

This button is used for setting Fan Speed in the sequence that goes from AUTO, 🌀, 🌀, 🌀, 🌀, 🌀, 🌀, then back to Auto.

*Note: Fan speed under dry mode is low speed.

▲ ▼ button

Press "▲" or "▼" button to increase / decrease set temperature.
Under auto mode, temperature can be displayed;
Under auto mode, set temperature can be adjusted.
When setting TIMER ON or TIMER OFF, press "▲" or "▼" button to adjust the time.

Swing button

Press this button to set up & down swing angle.

Sleep button

Under Cool or Heat mode, press this button to turn on Sleep function. Press this button again to cancel Sleep function. Under Fan, Auto and Dry modes, this function is unavailable.

Temp button

Press this button, you can see indoor set temperature, indoor ambient temperature on indoor unit' s display. The setting on remote controller is selected circularly as below:



Turbo button

Under COOL or HEAT mode, press this button to turn to quick cool or quick heat mode.Press this button again to exit turbo function.

I Feel button

Press this button to start I FEEL function and " 🌡️ " will be displayed on the remote controller.

After this function is set, the remote controller will send the detected ambient temperature to the controller and the unit will automatically adjust the indoor temperature according to the detected temperature.

Press this button again to close I FEEL function and " 🌡️ " will disappear. When I FEEL function is turned on, the remote controller should be put within the area where indoor unit can receive the signal sent by the remote controller.

Timer button

Under ON status, press this button to set timer OFF;
 Under OFF status, press this button to set timer ON.
 Press this button once and the characters of HOUR ON (OFF) will flash to be displayed. Mean-while, press "▲" or "▼" button to adjust timer setting (time will change quickly if holding "▲" or "▼" button). Timer setting range is 0.5~24hours. Press this button again to confirm timer setting and the characters of HOUR ON (OFF)will stop flash-ing.
 If the characters are flashing but you haven't press timer button, timer setting status will be quit after 5s. If timer is confirmer, press this button again to cancel timer.

X-Fan button

Press this button in COOL or DRY mode to turn on X-fan function.
 When this function is started up, indoor fan will still operate at low fan speed for a while after turning off the unit by remote controller.

Light button

Press this button to turn on the display's light and press this button again to turn off the display's light.

Introduction for icons on display screen

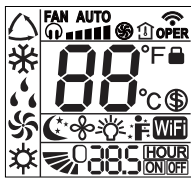

- Send signal
- Mode display
 - Auto
 - Cool
 - Dry
 - Fan
 - Heat
- Fan speed indication
- Turbo mode
- Indoor ambient temp
- Sleep mode
- X-FAN function
- Light
- I feel function
- WiFi function
- 8C heating function
- Child lock
- Set temperature
- Up & down swing
- Set time
- TIMER ON / TIMER OFF

Function introduction for combination buttons

▲ and ▼ About lock

Press "▲" and "▼" buttons simultaneously 3s to lock or unlock the keypad. If the remote controller is locked, is displayed. In this case, pressing any button, blinks three times.

Mode and ▼ About switch between °F and °C

At unit OFF, press "MODE" and "▼" buttons simultaneously to switch between °F and °C.

Temp and Timer About Energy-saving Function About 8°C Heating Function

Press "TEMP" and "TIMER" simultaneously in COOL mode to start energy-saving function.
 Nixie tube on the remote controller displays "SE".
 Repeat the operation to quit the function.

Press "TEMP" and "TIMER" simultaneously in HEAT mode to start 8°C Heating Function.
 Nixie tube on the remote controller displays "8" and a selected temperature of "8°C". (46°F if Fahrenheit is adopted). Repeat the operation to quit the function.
 This function is applicable for some models.

Mode and Fan About Auto clean function

Under unit off status, hold "MODE" and "FAN" buttons simultaneously for 5s to turn on or turn off the internal clean function. When the internal clean function is turned on, indoor unit displays "CL". During the self-cleaning process of evaporator, the unit will perform fast cooling or fast heating. There may be some noise, which is the sound of flowing liquid or thermal expansion or cold shrinkage. The air conditioner may blow cool or warm air, which is a normal phenomenon. During cleaning, please make sure the room is well ventilated to avoid affecting the degree of comfort.

Notice:

The self-cleaning function can only work under normal ambient temperature. If the room is dusty, clean once a month; if not, clean once every three months. After the self-cleaning function is turned on, you may leave the room. When self-cleaning is finished, the air conditioner will enter standby mode.
 This function is applicable for some models.

Mode and Turbo About WIFI function

Press "MODE" and "TURBO" button simultaneously to turn on or turn off WIFI function. When WIFI function is turned on, the icon will be displayed on remote controller; Long press "MODE" and "TURBO" buttons simultaneously for 10s, remote controller will send WIFI reset code and then the WIFI function will be turned on. WIFI function is defaulted ON after energization of the remote controller.
 This function is only available for some models.

Replacement of batteries in remote controller

1. Press the back side of remote controller marked with "OPEN", as shown in the fig, and then push out the cover of battery box along the arrow direction.
2. Replace two 7# (AAA 1.5V) dry batteries, and make sure the position of "+" polar and "-" polar are correct.
3. Reinstall the cover of battery box.

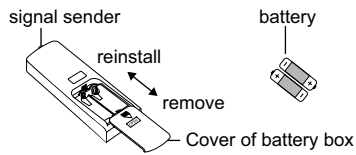

NOTICE:

During operation, point the remote control signal sender at the receiving window on indoor unit.

The distance between signal sender and receiving window should be no more than 8m, and there should be no obstacles between them.

Signal may be interfered easily in the room where there is fluorescent lamp or wireless telephone; remote controller should be close to indoor unit during operation.

Replace new batteries of the same model when replacement is required.

When you don't use remote controller for a long time, please take out the batteries.

If the display on remote controller is fuzzy or there's no display, please replace batteries.

6.4 GREE+ App Operation Manual

Control Flow Chart

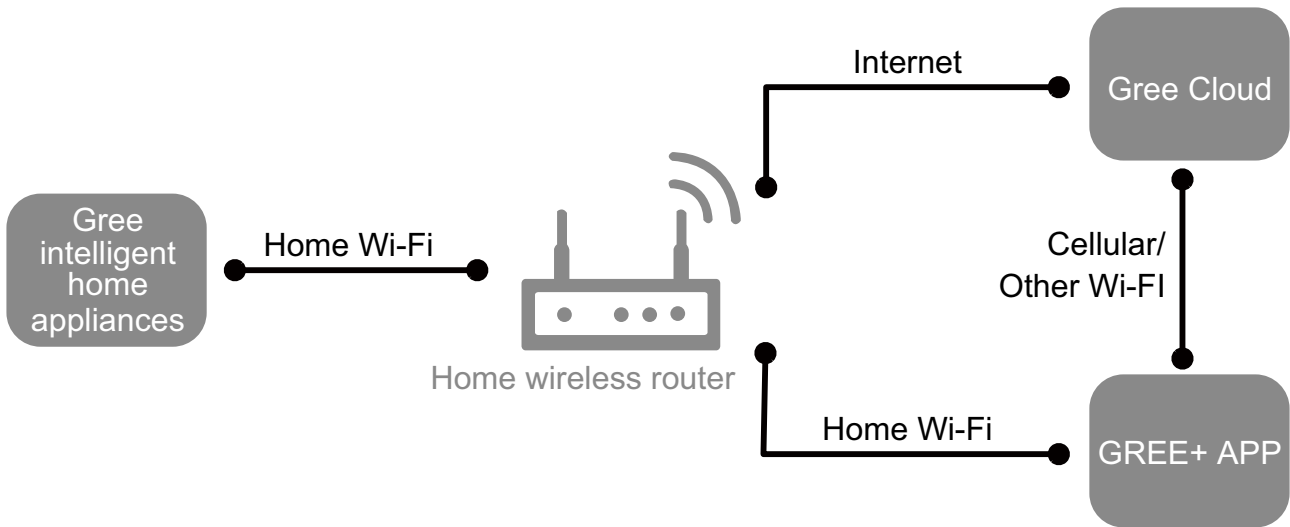

Operating Systems

Requirement for User's smart phone:



iOS system
Support iOS7.0 and
above version



Android system
Support Android 4.4 and
above version

Download and installation



GREE+ App Download Linkage

Scan the QR code or search "GREE+" in the application market to download and install it. When "GREE+" App is installed, register the account and add the device to achieve long-distance control and LAN control of Gree smart home appliances. For more information, please refer to "Help" in App.

6.5 Ewpe Smart App Operation Manual

Control Flow Chart

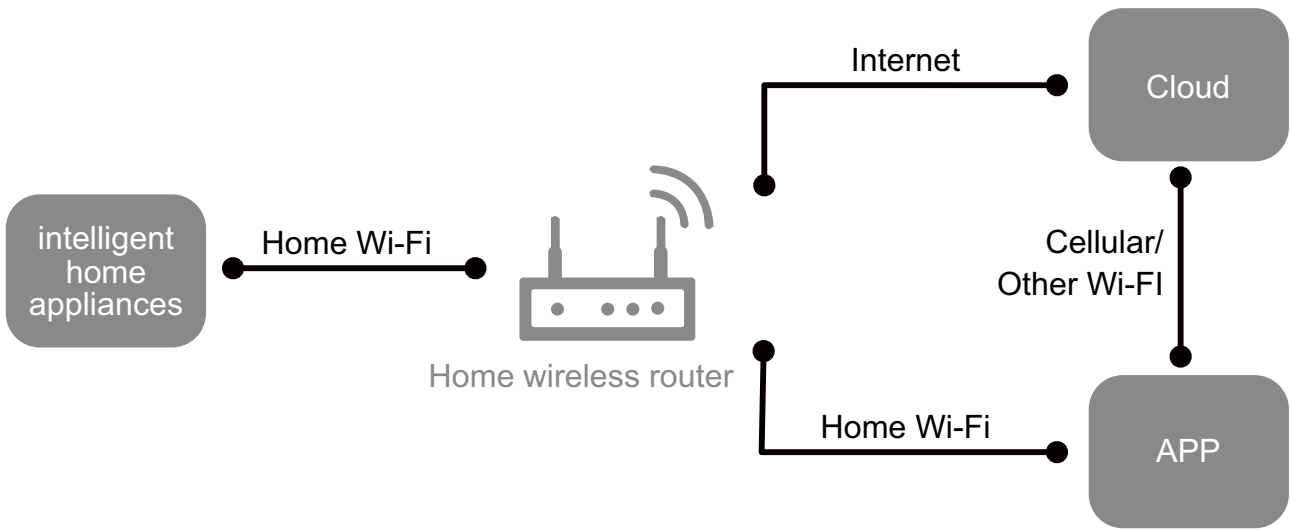

Operating Systems

Requirement for User's smart phone:



iOS system
Support iOS7.0 and
above version



Android system
Support Android 4.4 and
above version

Download and installation



App Download Linkage

Scan the QR code or search "Ewpe Smart" in the application market to download and install it. When "Ewpe Smart" App is installed, register the account and add the device to achieve long-distance control and LAN control of smart home appliances. For more information, please refer to "Help" in App.

6.6 Brief Description of Models and Functions

●Indoor Unit

1.Basic function of system

(1)Cooling mode

(1) Under this mode, fan and swing operates at setting status. Temperature setting range is 16~30°C.

(2) During malfunction of outdoor unit or the unit is stopped because of protection, indoor unit keeps original operation status.

(2)Drying mode

(1) Under this mode, fan operates at low speed and swing operates at setting status. Temperature setting range is 16~30°C.

(2) During malfunction of outdoor unit or the unit is stopped because of protection, indoor unit keeps original operation status.

(3) Protection status is same as that under cooling mode.

(4) Sleep function is not available for drying mode.

(3)Heating mode

(1) Under this mode, Temperature setting range is 16~30°C.

(2) Working condition and process for heating mode:

When turn on the unit under heating mode, indoor unit enters into cold air prevention status. When the unit is stopped or at OFF status, and indoor unit has been started up just now, the unit enters into residual heat-blowing status.

(4)Working method for AUTO mode:

1.Working condition and process for AUTO mode:

a.Under AUTO mode, standard heating $T_{\text{preset}}=20^{\circ}\text{C}$ and standard cooling $T_{\text{preset}}=25^{\circ}\text{C}$. The unit will switch mode automatically according to ambient temperature.

2.Protection function

a. During cooling operation, protection function is same as that under cooling mode.

b. During heating operation, protection function is same as that under heating mode.

3. Display: Set temperature is the set value under each condition. Ambient temperature is ($T_{\text{amb.}}-T_{\text{compensation}}$) for heat pump unit and $T_{\text{amb.}}$ for cooling only unit.

4. If theres I feel function, $T_{\text{compensation}}$ is 0. Others are same as above.

(5)Fan mode

Under this mode, indoor fan operates at set fan speed. Compressor, outdoor fan, 4-way valve and electric heating tube stop operation. Indoor fan can select to operate at high, medium, low or auto fan speed. Temperature setting range is 16~30°C.

2. Other control

(1) Buzzer

Upon energization or availably operating the unit or remote controller, the buzzer will give out a beep.

(2) Auto button

If press this auto button when turning off the unit, the complete unit will operate at auto mode. Indoor fan operates at auto fan speed and swing function is turned on. Press this auto button at ON status to turn off the unit.

(3) Auto fan

Heating mode: During auto heating mode or normal heating ode, auto fan speed will adjust the fan speed automatically according to ambient temperature and set temperature.

(4) Sleep

After setting sleep function for a period of time, system will adjust set temperature automatically.

(5) Timer function:

General timer and clock timer functions are compatible by equipping remote controller with different functions.

(6) Memory function

memorize compensation temperature, off-peak energization value. Memory content: mode, up&down swing, light, set temperature, set fan speed, general timer (clock timer can't be memorized).

After power recovery, the unit will be turned on automatically according to memory content.

(7) Health function

During operation of indoor fan, set health function by remote controller. Turn off the unit will also turn off health function.

Turn on the unit by pressing auto button, and the health is defaulted ON.

(8)I feel control mode

After controller received I feel control signal and ambient temperature sent by remote controller, controller will work according to the ambient temperature sent by remote controller.

(9)Entry condition for compulsory defrosting function

When turn on the unit under heating ode and set temperature is 16°C (or 16.5°C by remote controller), press “ \triangle , ∇ , \triangle , ∇ , \triangle , ∇ ” button successively within 5s and then indoor unit will enter into compulsory defrosting setting status:

(1) If theres only indoor units controller, it enters into indoor normal defrosting mode.

(2) If theres indoor units controller and outdoor units controller, indoor unit will send compulsory defrosting mode signal to outdoor unit and then outdoor unit will operate under normal defrosting mode. After indoor unit received the signal that outdoor unit has entered into defrosting status, indoor unit will cancel to send compulsory mode to outdoor unit. If outdoor unit hasnt received feedback signal from outdoor unit after 3min, indoor unit will also cancel to send compulsory defrosting signal.

(10)Refrigerant recovery function:

Enter into Freon recovery mode actively: Within 5min after energization, turn on the unit at 16°C under cooling mode, and press light button for 3 times within 3s to enter into Freon recovery mode. Fo is displayed and Freon recovery mode will be sent to outdoor unit.

(11)Ambient temperature display control mode

1. When user set the remote controller to display set temperature (corresponding remote control code: 01), current set temperature will be displayed.

2. Only when remote control signal is switched to indoor ambient temperature display status (corresponding remote control code: 10) from other display status (corresponding remote control code: 00, 01,11),controller will display indoor ambient temperature for 3s and then turn back to display set temperature.

Under this mode, indoor fan operates at set fan speed. Compressor, outdoor fan, 4-way valve and electric heating tube stop operation. Indoor fan can select to operate at high, medium, low or auto fan speed. Temperature setting range is 16~30°C.

(12)Off-peak energization function:

Adjust compressors minimum stop time. The original minimum stop time is 180s and then we change to:

The time interval between two start-ups of compressor can't be less than $180+T_s(0\leq T_s\leq 15)$. T is the variable of controller. Thats to say the minimum stop time of compressor is 180s~195s. Read-in T into memory chip when refurbish the memory chip each time.

After power recovery, compressor can only be started up after 180+T s at least.

(13) SE control mode

The unit operates at SE status.

(14) X-fan mode

When X-fan function is turned on, after turn off the unit, indoor fan will still operate at low speed for 2min and then the complete unit will be turned off. When x-fan function is turned off, after turn off the unit, the complete unit will be turned off directly.

(15) 8°C heating function

Under heating mode, you can set 8°C heating function by remote controller. The system will operate at 8°C set temperature.

(16) Turbo function

Turbo function can be set under cooling and heating modes. Press Fan Speed button to cancel turbo setting. Turbo function is not available under auto, drying and fan modes.

●Outdoor Unit

1. Cooling mode:

Working condition and process of cooling mode:

① When Tindoor ambient temperature $\geq T_{\text{preset}}$, unit enters into cooling mode. Indoor fan, outdoor fan and compressor start operation. Indoor fan operates according to set fan speed.

② When Tindoor ambient temperature $\leq T_{\text{preset}} - 2^{\circ}\text{C}$, compressor stops operation and outdoor fan will stop 30s later. Indoor fan operates according to set fan speed.

③ When $T_{\text{preset}} - 2^{\circ}\text{C} < T_{\text{indoor ambient temperature}} < T_{\text{preset}}$, unit operates according to the previous status.

Under cooling mode, 4-way valve is not energized. Temperature setting range is 16~30°C. If compressor stops because of malfunction in cooling mode, indoor fan and swing motor will work according to the original status.

2. Drying mode

(1) Working condition and process of drying mode

① When Tindoor ambient temperature $> T_{\text{preset}}$, unit will be in drying mode. Outdoor fan and compressor start operation while indoor fan will operate at low fan speed.

② When $T_{\text{preset}} - 2^{\circ}\text{C} \leq T_{\text{indoor ambient temperature}} \leq T_{\text{preset}}$, unit operates according to the previous status.

③ When Tindoor ambient temperature $< T_{\text{preset}} - 2^{\circ}\text{C}$, compressor stops operation and outdoor fan will stop 30s later.

(2) Under drying mode, 4-way valve is not energized. Temperature setting range is 16~30°C.

(3) Protection function: same as in cooling mode.

3. Fan mode

(1) Under this mode, indoor fan can select different fan speed (except Turbo) or auto fan speed. Compressor, outdoor fan and 4-way valve all stop operation.

(2) In fan mode, temperature setting range is 16~30°C.

4. Heating mode

Working condition and process of heating mode:

① When $T_{\text{preset}} - (T_{\text{indoor ambient temperature}} - T_{\text{compensation}}) \geq 1^{\circ}\text{C}$, unit enters into heating mode. Compressor, outdoor fan and 4-way valve start operation.

② When $-2^{\circ}\text{C} < T_{\text{preset}} - (T_{\text{indoor ambient temperature}} - T_{\text{compensation}}) < 1^{\circ}\text{C}$, unit operates according to the previous status.

③ When $T_{\text{preset}} - (T_{\text{indoor ambient temperature}} - T_{\text{compensation}}) \leq -$

2°C, compressor stops operation and outdoor fan will stop 30s later. Indoor fan will be in residual-heat blowing status.

④ When unit is turned off under heating mode or changed to other modes from heating mode, 4-way valve will be power-off 2min after compressor stops working (compressor is in operation status under heating mode).

⑤ When Toutdoor ambient temperature $> 30^{\circ}\text{C}$, compressor stops operation immediately. Outdoor fan will stop 30s later.

⑥ Under the condition that compressor is turned on, when unit is changed to heating mode from cooling or drying mode, 4-way valve will be energized in 2~3mins delay.

Note: Tcompensation is determined by IDU and ODU. If IDU controls the compensation temperature, then Tcompensation is determined according to the value sent by IDU to ODU; If IDU does not control the compensation temperature, then Tcompensation will default to 3°C by the ODU.

5. Freon recovery mode

After the Freon recovery signal from IDU is received, cooling at rated frequency will be forcibly turned on to recover Freon.

Indoor unit will display Fo. If any signal from remote controller is received, unit will exit from Freon recovery mode and indoor unit stops displaying Fo.

6. Compulsory defrosting

If unit is turned on under heating mode and set temperature is 16OC (by remote controller), press “ Δ , ∇ , Δ , ∇ , Δ , ∇ ” within 5s, unit will enter into compulsory defrosting mode and send the signal to ODU. When the compulsory defrosting signal from ODU is received, IDU will exit from the compulsory defrosting mode and stop sending the signal to ODU.

After ODU receives the compulsory defrosting code, it will start compulsory defrosting. Defrosting frequency and opening angle will be the same as in normal defrosting mode. When compulsory defrosting is finished, the complete unit resumes original status.

7. Auto mode

Auto mode is determined by controller of IDU. See IDU logic for details.

8. 8°C heating

Set temperature is 8°C. Display board of IDU displays 8°C. Under this mode, “Cold air prevention” function is shielded.

If compressor is operating under this mode, fan speed will adjust according to auto fan speed; if compressor stops operation under this mode, indoor fan will be in residual-heat blowing status.

When power on, communication light will be blinking in a normal way (after receiving a group of correct signals, blinking stops for 0.2s~0.3s). If theres no communication, communication light will be always on. If other ODU has malfunction, communication light will be on for 1s and off for 1s in a circular way.

7. Notes for Installation and Maintenance

Safety Precautions: Important!

Please read the safety precautions carefully before installation and maintenance.

The following contents are very important for installation and maintenance.

Please follow the instructions below.

- The installation or maintenance must accord with the instructions.
- Comply with all national electrical codes and local electrical codes.
- Pay attention to the warnings and cautions in this manual.
- All installation and maintenance shall be performed by distributor or qualified person.
- All electric work must be performed by a licensed technician according to local regulations and the instructions given in this manual.
- Be caution during installation and maintenance. Prohibit incorrect operation to prevent electric shock, casualty and other accidents.



WARNINGS

Electrical Safety Precautions:

1. Cut off the power supply of air conditioner before checking and maintenance.
2. The air condition must apply specialized circuit and prohibit share the same circuit with other appliances.
3. The air conditioner should be installed in suitable location and ensure the power plug is touchable.
4. Make sure each wiring terminal is connected firmly during installation and maintenance.
5. Have the unit adequately grounded. The grounding wire can't be used for other purposes.
6. Must apply protective accessories such as protective boards, cable-cross loop and wire clip.
7. The live wire, neutral wire and grounding wire of power supply must be corresponding to the live wire, neutral wire and grounding wire of the air conditioner.
8. The power cord and power connection wires can't be pressed by hard objects.
9. If power cord or connection wire is broken, it must be replaced by a qualified person.
10. If the power cord or connection wire is not long enough, please get the specialized power cord or connection wire from the manufacture or distributor. Prohibit prolong the wire by yourself.
11. For the air conditioner without plug, an air switch must be installed in the circuit. The air switch should be all-pole parting and the contact parting distance should be more than 3mm.

12. Make sure all wires and pipes are connected properly and the valves are opened before energizing.
13. Check if there is electric leakage on the unit body. If yes, please eliminate the electric leakage.
14. Replace the fuse with a new one of the same specification if it is burnt down; dont replace it with a cooper wire or conducting wire.
15. If the unit is to be installed in a humid place, the circuit breaker must be installed.

Installation Safety Precautions:

1. Select the installation location according to the requirement of this manual.(See the requirements in installation part)
2. Handle unit transportation with care; the unit should not be carried by only one person if it is more than 20kg.
3. When installing the indoor unit and outdoor unit, a sufficient fixing bolt must be installed; make sure the installation support is firm.
4. Ware safety belt if the height of working is above 2m.
5. Use equipped components or appointed components during installation.
6. Make sure no foreign objects are left in the unit after finishing installation.

Refrigerant Safety Precautions:

1. When refrigerant leaks or requires discharge during installation, maintenance, or disassembly, it should be handled by certified professionals or otherwise in compliance with local laws and regulations.
- 2.Avoid contact between refrigerant and fire as it generates poisonous gas; Prohibit prolong the connection pipe by welding.
3. Apply specified refrigerant only. Never have it mixed with any other refrigerant. Never have air remain in the refrigerant line as it may lead to rupture or other hazards.
4. Make sure no refrigerant gas is leaking out when installation is completed.
5. If there is refrigerant leakage, please take sufficient measure to minimize the density of refrigerant.
6. Never touch the refrigerant piping or compressor without wearing glove to avoid scald or frostbite.

Improper installation may lead to fire hazard, explosion, electric shock or injury.

Safety Precautions for Installing and Relocating the Unit:

To ensure safety, please be mindful of the following precautions.

WARNINGS

1. When installing or relocating the unit, be sure to keep the refrigerant circuit free from air or substances other than the specified refrigerant.

Any presence of air or other foreign substance in the refrigerant circuit will cause system pressure rise or compressor rupture, resulting in injury.

2. When installing or moving this unit, do not charge the refrigerant which is not comply with that on the nameplate or unqualified refrigerant.

Otherwise, it may cause abnormal operation, wrong action, mechanical malfunction or even series safety accident.

3. When refrigerant needs to be recovered during relocating or repairing the unit, be sure that the unit is running in cooling mode. Then, fully close the valve at high pressure side (liquid valve). About 30-40 seconds later, fully close the valve at low pressure side (gas valve), immediately stop the unit and disconnect power. Please note that the time for refrigerant recovery should not exceed 1 minute.

If refrigerant recovery takes too much time, air may be sucked in and cause pressure rise or compressor rupture, resulting in injury.

4. During refrigerant recovery, make sure that liquid valve and gas valve are fully closed and power is disconnected before detaching the connection pipe.

If compressor starts running when stop valve is open and connection pipe is not yet connected, air will be sucked in and cause pressure rise or compressor rupture, resulting in injury.

5. When installing the unit, make sure that connection pipe is securely connected before the compressor starts running.

If compressor starts running when stop valve is open and connection pipe is not yet connected, air will be sucked in and cause pressure rise or compressor rupture, resulting in injury.

6. Prohibit installing the unit at the place where there may be leaked corrosive gas or flammable gas.

If there leaked gas around the unit, it may cause explosion and other accidents.

7. Do not use extension cords for electrical connections. If the electric wire is not long enough, please contact a local service center authorized and ask for a proper electric wire.

Poor connections may lead to electric shock or fire.

8. Use the specified types of wires for electrical connections between the indoor and outdoor units. Firmly clamp the wires so that their terminals receive no external stresses.

Electric wires with insufficient capacity, wrong wire connections and insecure wire terminals may cause electric shock or fire.

Safety Precautions for Refrigerant

- To realize the function of the air conditioner unit, a special refrigerant circulates in the system. The used refrigerant is the fluoride R32, which is specially cleaned. The refrigerant is flammable and odorless. Furthermore, it can lead to explosion under certain conditions. But the flammability of the refrigerant is very low. It can be ignited only by fire.
- Compared to common refrigerants, R32 is a nonpolluting refrigerant with no harm to the ozone layer. The influence upon the greenhouse effect is also lower. R32 has got very good thermodynamic features which lead to a really high energy efficiency. The units therefore need a less filling.

WARNING:

- Do not use means to accelerate the defrosting process or to clean, other than those recommended by the manufacturer. Should repair be necessary, contact your nearest authorized Service Centre. Any repairs carried out by unqualified personnel may be dangerous. The appliance shall be stored in a room without continuously operating ignition sources. (for example: open flames, an operating gas appliance or an operating electric heater.)
- Do not pierce or burn.
- Appliance shall be installed, operated and stored in a room with a floor area larger than Xm^2 .
- Appliance filled with flammable gas R32. For repairs, strictly follow manufacturer's instructions only. Be aware that refrigerants do not contain odor.
- Read specialist manual.

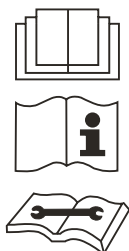

Safety Operation of Flammable Refrigerant

Qualification requirement for installation and maintenance man

- Any person who is involved with working on or breaking into a refrigerant circuit should hold a current valid certificate from an industry-accredited assessment authority, which authorizes their competence to handle refrigerants safely in accordance with an industry recognised assessment specification.
- Servicing shall only be performed as recommended by the equipment manufacturer. Maintenance and repair requiring the assistance of other skilled personnel shall be carried out under the supervision of the person competent in the use of flammable refrigerants.

Installation notes

- The air conditioner is not allowed to use in a room that

has running fire (such as fire source, working coal gas ware, operating heater).

- It is not allowed to drill hole or burn the connection pipe.
- The air conditioner must be installed in a room that is larger than the minimum room area. The minimum room area is shown on the nameplate or following table a.
- Leak test is a must after installation.

table a - Minimum room area (m^2)

Charge amount (kg)	floor location	window mounted	wall mounted	ceiling mounted
≤1.2	/	/	/	/
1.3	14.5	5.2	1.6	1.1
1.4	16.8	6.1	1.9	1.3
1.5	19.3	7	2.1	1.4
1.6	22	7.9	2.4	1.6
1.7	24.8	8.9	2.8	1.8
1.8	27.8	10	3.1	2.1
1.9	31	11.2	3.4	2.3
2	34.3	12.4	3.8	2.6
2.1	37.8	13.6	4.2	2.8
2.2	41.5	15	4.6	3.1
2.3	45.4	16.3	5	3.4
2.4	49.4	17.8	5.5	3.7
2.5	53.6	19.3	6	4

Maintenance notes

- Check whether the maintenance area or the room area meet the requirement of the nameplate.
 - Its only allowed to be operated in the rooms that meet the requirement of the nameplate.
- Check whether the maintenance area is well-ventilated.
 - The continuous ventilation status should be kept during the operation process.
- Check whether there is fire source or potential fire source in the maintenance area.
 - The naked flame is prohibited in the maintenance area; and the “no smoking” warning board should be hanged.
- Check whether the appliance mark is in good condition.
 - Replace the vague or damaged warning mark.

Welding

- If you should cut or weld the refrigerant system pipes in the process of maintaining, please follow the steps as below:
 - a. Shut down the unit and cut power supply
 - b. Eliminate the refrigerant
 - c. Vacuuming
 - d. Clean it with N_2 gas
 - e. Cutting or welding
 - f. Carry back to the service spot for welding
- Make sure that there isn't any naked flame near the outlet of the vacuum pump and its well-ventilated.

- The refrigerant should be recycled into the specialized storage tank.

Filling the refrigerant

- Use the refrigerant filling appliances specialized for R32. Make sure that different kinds of refrigerant wont contaminate with each other.
- The refrigerant tank should be kept upright at the time of filling refrigerant.
- Stick the label on the system after filling is finished (or havent finished).
- Dont overfilling.
- After filling is finished, please do the leakage detection before test running; another time of leak detection should be done when its removed.

Safety instructions for transportation and storage

- Please use the flammable gas detector to check before unload and open the container.
- No fire source and smoking.
- According to the local rules and laws.

Prior to beginning work on systems containing flammable refrigerants, safety checks are necessary to ensure that the risk of ignition is minimised. For repair to the refrigerating system, the following precautions shall be complied with prior to conducting work on the system.

●Work procedure

Work shall be undertaken under a controlled procedure so as to minimise the risk of a flammable gas or vapour being present while the work is being performed.

●General work area

All maintenance staff and others working in the local area shall be instructed on the nature of work being carried out. Work in confined spaces shall be avoided. The area around the workspace shall be sectioned off. Ensure that the conditions within the area have been made safe by control of flammable material

●Checking for presence of refrigerant

The area shall be checked with an appropriate refrigerant detector prior to and during work, to ensure the technician is aware of potentially toxic or flammable atmospheres.

Ensure that the leak detection equipment being used is suitable for use with all applicable refrigerants, i.e. non-sparking, adequately sealed or intrinsically safe.

●Presence of fire extinguisher

If any hot work is to be conducted on the refrigeration equipment or any associated parts, appropriate fire extinguishing equipment shall be available to hand. Have a dry powder or CO₂ fire extinguisher adjacent to the charging area.

●No ignition sources

No person carrying out work in relation to a refrigeration system which involves exposing any pipe work shall use any sources of ignition in such a manner that it may lead to the risk of fire or explosion. All possible ignition sources, including cigarette smoking, should be kept sufficiently far away from the site of installation, repairing, removing and disposal, during which refrigerant can possibly be released to the surrounding space. Prior to work taking place, the area around the equipment is to be

surveyed to make sure that there are no flammable hazards or ignition risks. “ NO Smoking ” signs shall be displayed.

●Ventilated area

Ensure that the area is in the open or that it is adequately ventilated before breaking into the system or conducting any hot work. A degree of ventilation shall continue during the period that the work is carried out. The ventilation should safely disperse any released refrigerant and preferably expel it externally into the atmosphere.

●Checks to the refrigeration equipment

Where electrical components are being changed, they shall be fit for the purpose and to the correct specification. At all times the manufacturer’s maintenance and service guidelines shall be followed. If in doubt, consult the manufacturer’s technical department for assistance.

The following checks shall be applied to installations using flammable refrigerants:

- The actual refrigerant charge is in accordance with the room size within which the refrigerant containing parts are installed;
- The ventilation machinery and outlets are operating adequately and are not obstructed;
- If an indirect refrigerating circuit is being used, the secondary circuit shall be checked for the presence of refrigerant;
- Marking to the equipment continues to be visible and legible. Markings and signs that are illegible shall be corrected;
- Refrigeration pipe or components are installed in a position where they are unlikely to be exposed to any substance which may corrode refrigerant containing components, unless the components are constructed of materials which are inherently resistant to being corroded or are suitably protected against being so corroded.

●Checks to electrical devices

Repair and maintenance to electrical components shall include initial safety checks and component inspection procedures. If a fault exists that could compromise safety, then no electrical supply shall be connected to the circuit until it is satisfactorily dealt with. If the fault cannot be corrected immediately but it is necessary to continue operation, an adequate temporary solution shall be used. This shall be reported to the owner of the equipment so all parties are advised.

Initial safety checks shall include:

- 1.That capacitors are discharged: this shall be done in a safe manner to avoid possibility of sparking;
- 2.That no live electrical components and wiring are exposed while charging, recovering or purging the system;
- 3.That there is continuity of earth bonding.

●Repairs to sealed components

1. During repairs to sealed components, all electrical supplies shall be disconnected from the equipment being worked upon prior to any removal of sealed covers, etc. If it is absolutely necessary to have an electrical supply to equipment during servicing, then a permanently operating form of leak detection shall be located at the most critical point to warn of a potentially hazardous situation.
2. Particular attention shall be paid to the following to ensure that by working on electrical components, the casing is not altered in such a way that the level of protection is affected. This shall include damage to cables, excessive number of connections,

terminals not made to original specification, damage to seals, incorrect fitting of glands, etc.

Ensure that the apparatus is mounted securely.

Ensure that seals or sealing materials have not degraded to the point that they no longer serve the purpose of preventing the ingress of flammable atmospheres.

Replacement parts shall be in accordance with the manufacturer's specifications.

NOTE : The use of silicon sealant can inhibit the effectiveness of some types of leak detection equipment. Intrinsically safe components do not have to be isolated prior to working on them.

●Repair to intrinsically safe components

Do not apply any permanent inductive or capacitance loads to the circuit without ensuring that this will not exceed the permissible voltage and current permitted for the equipment in use.

Intrinsically safe components are the only types that can be worked on while live in the presence of a flammable atmosphere. The test apparatus shall be at the correct rating.

Replace components only with parts specified by the manufacturer. Other parts may result in the ignition of refrigerant in the atmosphere from a leak.

●Cabling

Check that cabling will not be subject to wear, corrosion, excessive pressure, vibration, sharp edges or any other adverse environmental effects. The check shall also take into account the effects of aging or continual vibration from sources such as compressors or fans.

●Detection of flammable refrigerants

Under no circumstances shall potential sources of ignition be used in the searching for or detection of refrigerant leaks. A halide torch (or any other detector using a naked flame) shall not be used.

●Leak detection methods

The following leak detection methods are deemed acceptable for all refrigerant systems.

Electronic leak detectors may be used to detect refrigerant leaks but, in the case of flammable refrigerants, the sensitivity may not be adequate, or may need re-calibration.

(Detection equipment shall be calibrated in a refrigerant-free area.)

Ensure that the detector is not a potential source of ignition and is suitable for the refrigerant used.

Leak detection equipment shall be set at a percentage of the LFL of the refrigerant and shall be calibrated to the refrigerant employed, and the appropriate percentage of gas (25 % maximum) is confirmed.

Leak detection fluids are suitable for use with most refrigerants but the use of detergents containing chlorine shall be avoided as the chlorine may react with the refrigerant and corrode the copper pipe-work.

If a leak is suspected, all naked flames shall be removed/ extinguished.

If a leakage of refrigerant is found which requires brazing, all of the refrigerant shall be recovered from the system, or isolated (by means of shut off valves) in a part of the system remote from the leak. For appliances containing flammable refrigerants, oxygen free nitrogen (OFN) shall then be purged through the system both before and during the brazing process.

●Removal and evacuation

When breaking into the refrigerant circuit to make repairs – or for any other purpose –conventional procedures shall be used. However, for flammable refrigerants it is important that best practice is followed since flammability is a consideration. The following procedure shall be adhered to:

- 1.remove refrigerant;
- 2.purge the circuit with inert gas; evacuate;
- 3.purge again with inert gas;
- 4.open the circuit by cutting or brazing.

The refrigerant charge shall be recovered into the correct recovery cylinders.

For appliances containing flammable refrigerants, the system shall be “flushed” with OFN to render the unit safe. This process may need to be repeated several times.Compressed air or oxygen

Main Tools for Installation and Maintenance



Level meter



Measuring tape



Screw driver



Impact drill



Drill head



Electric drill



Electroprobe



Universal meter



Torque wrench



Open-end wrench



Inner hexagon spanner



Electronic leakage detector



Vacuum pump



Pressure meter



Pipe pliers



Pipe pliers



Pipe cutter



Pipe expander



Pipe bender



Soldering appliance



Refrigerant container



Electronic scale

8. Installation

8.1 Installation Dimension Diagram

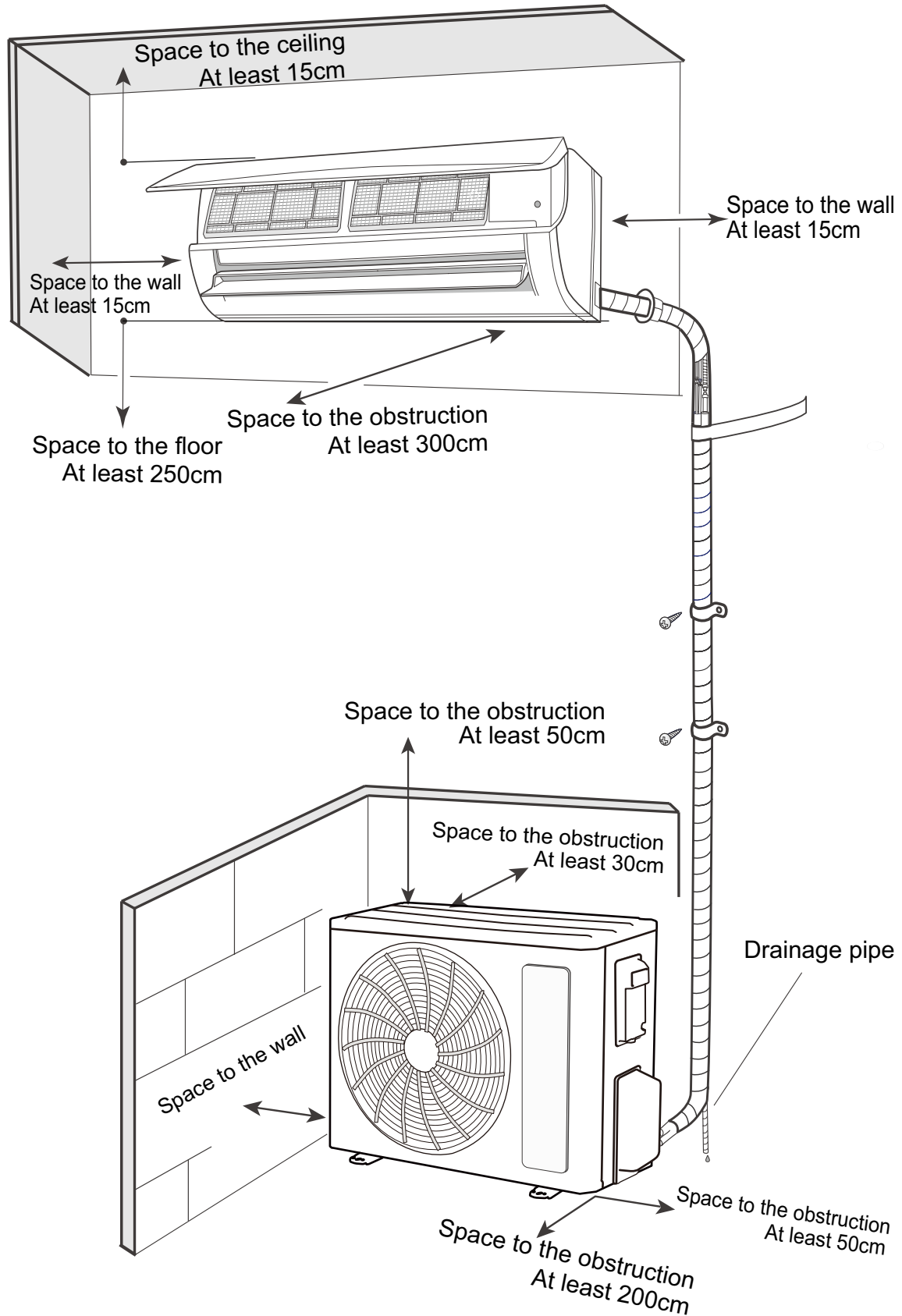

Installation Procedures

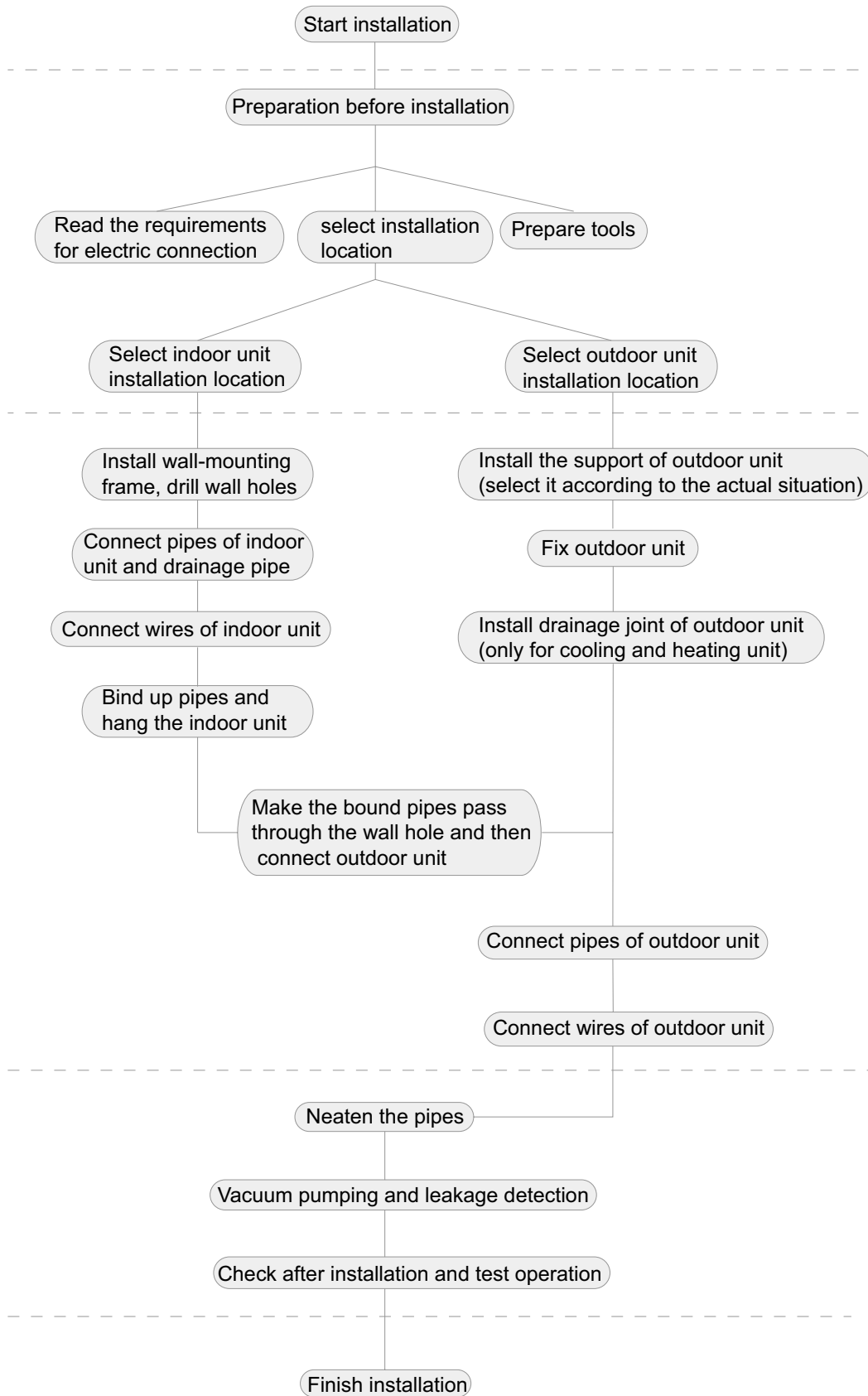

Note: this flow is only for reference; please find the more detailed installation steps in this se

8.2 Installation Parts-checking

No.	Name
1	Indoor unit
2	Outdoor unit
3	Connection pipe
4	Drainage pipe
5	Wall-mounting frame
6	Connecting cable(power cord)
7	Wall pipe
8	Sealing gum
9	Wrapping tape
10	Support of outdoor unit
11	Fixing screw
12	Drainage plug(cooling and heating unit)
13	Owners manual, remote controller

⚠ Note:

- 1.Please contact the local agent for installation.
- 2.Dont use unqualified power cord.

8.3 Selection of Installation Location

1. Basic Requirement:

Installing the unit in the following places may cause malfunction. If it is unavoidable, please consult the local dealer:

- (1) The place with strong heat sources, vapors, flammable or explosive gas, or volatile objects spread in the air.
- (2) The place with high-frequency devices (such as welding machine, medical equipment).
- (3) The place near coast area.
- (4) The place with oil or fumes in the air.
- (5) The place with sulfured gas.
- (6) Other places with special circumstances.
- (7) The appliance shall not be installed in the laundry.
- (8) It's not allowed to be installed on the unstable or motive base structure(such as truck) or in the corrosive environment (such as chemical factory).

2. Indoor Unit:

- (1) There should be no obstruction near air inlet and air outlet.
- (2) Select a location where the condensation water can be dispersed easily and wont affect other people.
- (3) Select a location which is convenient to connect the outdoor unit and near the power socket.
- (4) Select a location which is out of reach for children.
- (5) The location should be able to withstand the weight of indoor unit and wont increase noise and vibration.
- (6) The appliance must be installed 2.5m above floor.
- (7) Dont install the indoor unit right above the electric appliance.
- (8) Please try your best to keep way from fluorescent lamp.

3. Outdoor Unit:

- (1) Select a location where the noise and outflow air emitted by the outdoor unit will not affect neighborhood.
- (2) The location should be well ventilated and dry, in which the outdoor unit wont be exposed directly to sunlight or strong wind.

(3) The location should be able to withstand the weight of outdoor unit.

(4) Make sure that the installation follows the requirement of installation dimension diagram.

(5) Select a location which is out of reach for children and far away from animals or plants.If it is unavoidable, please add fence for safety purpose.

8.4 Electric Connection Requirement

1. Safety Precaution

(1) Must follow the electric safety regulations when installing the unit.

(2) According to the local safety regulations, use qualified power supply circuit and air switch.

(3) Make sure the power supply matches with the requirement of air conditioner. Unstable power supply or incorrect wiring may result in electric shock,fire hazard or malfunction. Please install proper power supply cables before using the air conditioner.

(4) Properly connect the live wire, neutral wire and grounding wire of power socket.

(5) Be sure to cut off the power supply before proceeding any work related to electricity and safety.

(6) Do not put through the power before finishing installation.

(7) If the supply cord is damaged, it must be replaced by the manufacturer, its service agent or similarly qualified persons in order to avoid a hazard .

(8) The temperature of refrigerant circuit will be high, please keep the interconnection cable away from the copper tube.

(9) The appliance shall be installed in accordance with national wiring regulations.

(10) Appliance shall be installed, operated and stored in a room with a floor area larger than Xm^2 (Please refer to table "a" in section of " Safety Operation of Inflammable Refrigerant" for Space X.)



Please notice that the unit is filled with flammable gas R32. Inappropriate treatment of the unit involves the risk of severe damages of people and material. Details to this refrigerant are found in chapter "refrigerant".

2. Grounding Requirement:

(1) The air conditioner is the first class electric appliance.It must be properly grounding with specialized grounding device by a professional.

Please make sure it is always grounded effectively,otherwise it may cause electric shock.

(2) The yellow-green wire in air conditioner is grounding wire, which can't be used for other purposes.

(3) The grounding resistance should comply with national electric safety regulations.

(4) The appliance must be positioned so that the plug is accessible.

(5) An all-pole disconnection switch having a contact separation of at least 3mm in all poles should be connected in fixed wiring.

(6) Including an air switch with suitable capacity, please note the following table. Air switch should be included magnet buckle and heating buckle function, it can protect the circuit-short and overload. (Caution: please do not use the fuse only for protect the circuit)

Model	Air switch capacity	Power cord
07K	10A	3G1.0
09K	10A	3G1.0
12K	10A	3G1.0
24K	16A	3G1.5

8.5 Installation of Indoor Unit

1. Choosing Installation location

Recommend the installation location to the client and then confirm it with the client.

2. Install Wall-mounting Frame

(1) Hang the wall-mounting frame on the wall; adjust it in horizontal position with the level meter and then point out the screw fixing holes on the wall.

(2) Drill the screw fixing holes on the wall with impact drill (the specification of drill head should be the same as the plastic expansion particle) and then fill the plastic expansion particles in the holes.

(3) Fix the wall-mounting frame on the wall with tapping screws and then check if the frame is firmly installed by pulling the frame. If the plastic expansion particle is loose, please drill another fixing hole nearby.

3. Install Wall-mounting Frame

(1) Choose the position of piping hole according to the direction of outlet pipe. The position of piping hole should be a little lower than the wall-mounted frame, shown as below. (As show in Fig.1)

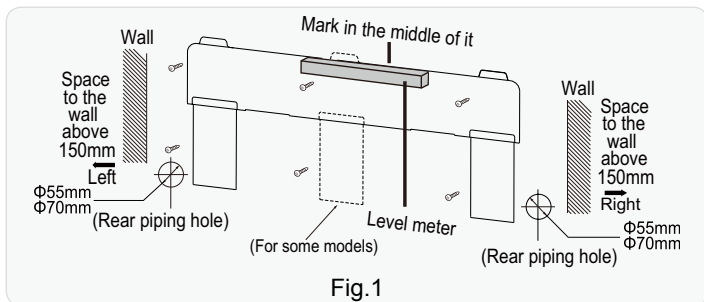

(2) Open a piping hole with the diameter of Φ55mm or Φ70mm on the selected outlet pipe position. In order to drain smoothly, slant the piping hole on the wall slightly downward to the outdoor side with the gradient of 5-10°. (As show in Fig.2)

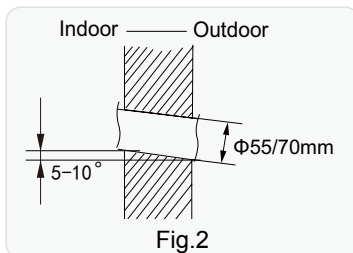

NOTE:

Pay attention to dust prevention and take relevant safety measures when opening the hole.

4. Outlet Pipe

(1) The pipe can be led out in the direction of right, rear right, left or rear left. (As show in Fig.3)

(2) When selecting leading out the pipe from left or right, please cut off the corresponding hole on the bottom case. (As show in Fig.4)

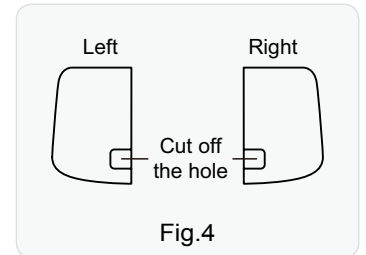
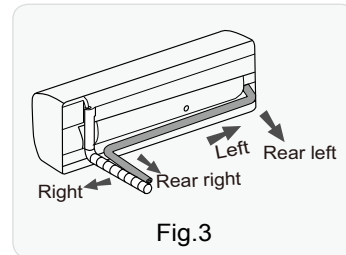

5. Connect the Pipe of Indoor Unit

(1) Aim the pipe joint at the corresponding bellmouth. (As show in Fig.5)

(2) Pretightening the union nut with hand.

(3) Adjust the torque force by referring to the following sheet. Place the open-end wrench on the pipe joint and place the torque wrench on the union nut. Tighten the union nut with torque wrench. (As show in Fig.6)

(4) Wrap the indoor pipe and joint of connection pipe with insulating pipe, and then wrap it with tape. (As show in Fig.7)

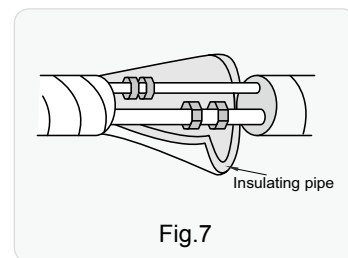
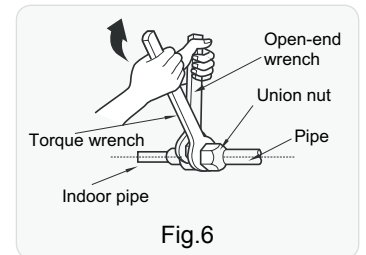
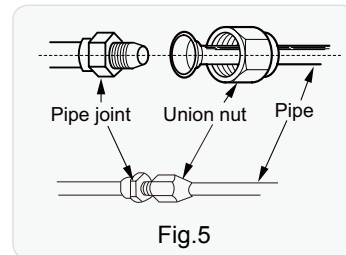

Refer to the following table for wrench moment of force:

Piping size	Tightening torque(N·m)
1/4"	15~20
3/8"	30~40
1/2"	45~55
5/8"	60~65
3/4"	70~75

6. Install Drain Hose

(1) Connect the drain hose to the outlet pipe of indoor unit.(As show in Fig.8)

(2) Bind the joint with tape.(As show in Fig.9)

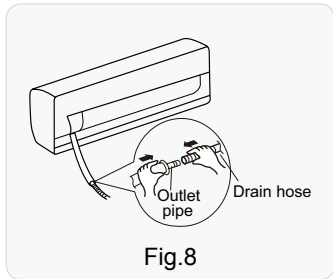

Fig.8

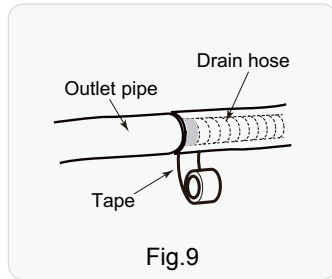

Fig.9

NOTE:

(1) Add insulating pipe in the indoor drain hose in order to prevent condensation.

(2) The plastic expansion particles are not provided.

(As show in Fig.10)

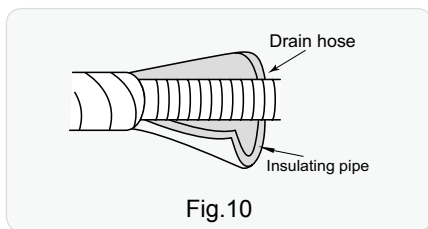

Fig.10

7. Connect Wire of Indoor Unit

(1) Open the panel, remove the screw on the wiring cover and then take down the cover.(As show in Fig.11)

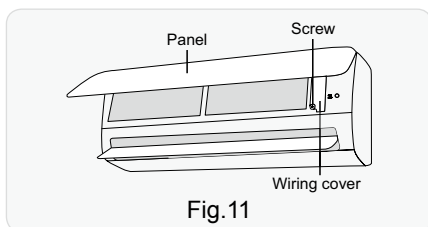

Fig.11

(2) Make the power connection wire go through the cable-cross hole at the back of indoor unit and then pull it out from the front side.(As show in Fig.12)

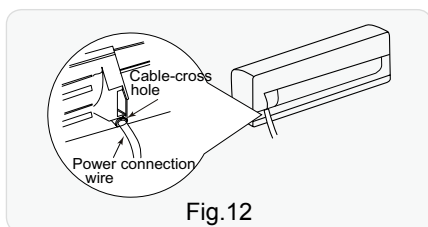

Fig.12

(3) Remove the wire clip; connect the power connection wire signal control wire (only for cooling and heating unit) to the wiring terminal according to the color; tighten the screw and then fix the power connection wire with wire clip.(As show in Fig.13)

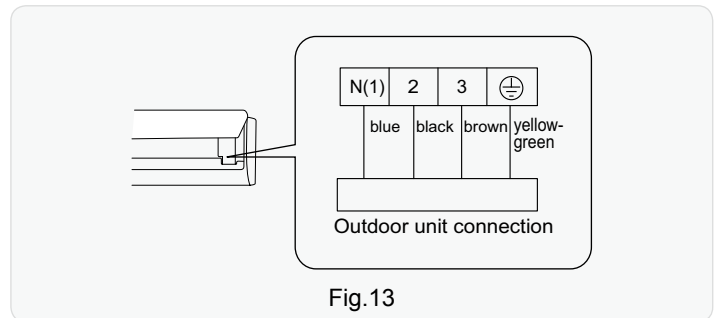

Fig.13

Note: The wiring connect is for reference only, please refer to the actual one.

(4) Put wiring cover back and then tighten the screw.

(5) Close the panel.

⚠ WARNING:

(1) All wires of indoor unit and outdoor unit should be connected by a professional.

(2) If the length of power connection wire is insufficient, please contact the supplier for a new one. Avoid extending the wire by yourself.

(3) For the air conditioner with plug, the plug should be reachable after finishing installation.

(4) For the air conditioner without plug, an air switch must be installed in the line. The air switch should be all-pole parting and the contact parting distance should be more than 3mm.

8. Bind up Pipe

(1) Bind up the connection pipe, power cord and drain hose with the band.(As show in Fig.14)

(2) Reserve a certain length of drain hose and power cord for installation when binding them. When binding to a certain degree, separate the indoor power and then separate the drain hose.(As show in Fig.15)

(3) Bind them evenly.

(4) The liquid pipe and gas pipe should be bound separately at the end.

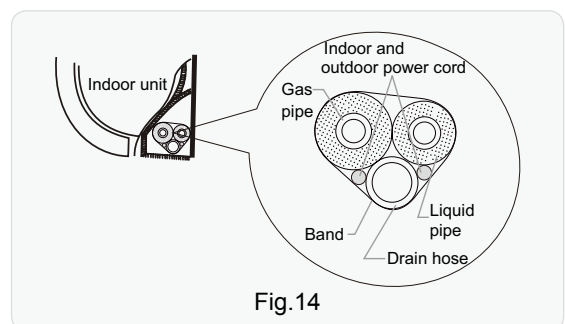

Fig.14

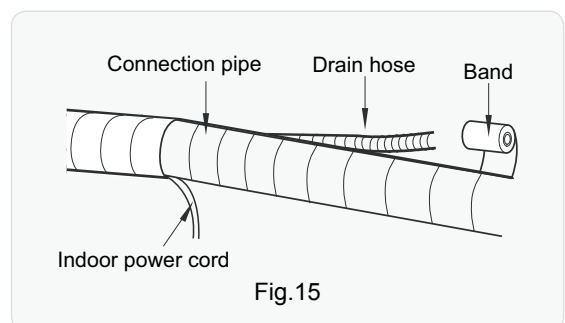

Fig.15

NOTICE:

- (1) The power cord and control wire can't be crossed or winding.
- (2) The drain hose should be bound at the bottom.

9. Hang the Indoor Unit

- (1) Put the bound pipes in the wall pipe and then make them pass through the wall hole.
- (2) Hang the indoor unit on the wall-mounting frame.
- (3) Stuff the gap between pipes and wall hole with sealing gum.
- (4) Fix the wall pipe.(As show in Fig.16)
- (5) Check if the indoor unit is installed firmly and closed to the wall.(As show in Fig.17)

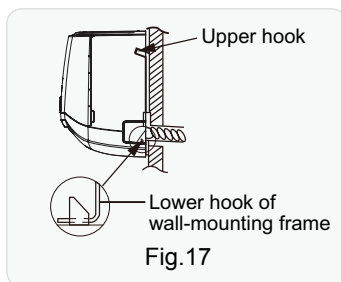
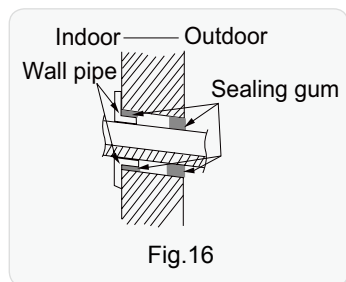

NOTICE:

Do not bend the drain hose too excessively in order to prevent blocking.

8.6 Installation of Outdoor unit

1. Fix the Support of Outdoor Unit(Select it according to the actual installation situation)

- (1) Select installation location according to the house structure.
- (2) Fix the support of outdoor unit on the selected location with expansion screws.

NOTICE:

- (1) Take sufficient protective measures when installing the outdoor unit.
- (2) Make sure the support can withstand at least four times the unit weight.
- (3) The outdoor unit should be installed at least 3cm above the floor in order to install drain joint.(As show in Fig.18)
- (4) For the unit with cooling capacity of 2300W~5000W, 6 expansion screws are needed; for the unit with cooling capacity of 6000W~8000W, 8 expansion screws are needed; for the unit with cooling capacity of 10000W~16000W, 10 expansion screws are needed.

2. Install Drain Joint(Only for cooling and heating unit)

- (1) Connect the outdoor drain joint into the hole on the chassis.
 - (2) Connect the drain hose into the drain vent.
- (As show in Fig.19)

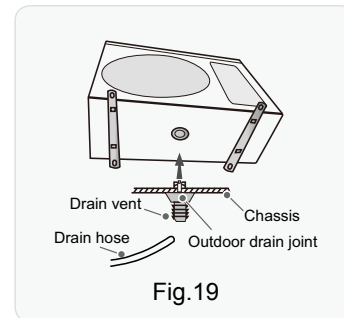
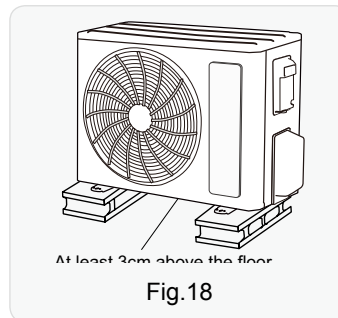

3. Fix Outdoor Unit

- (1) Place the outdoor unit on the support.
 - (2) Fix the foot holes of outdoor unit with bolts.
- (As show in Fig.20)

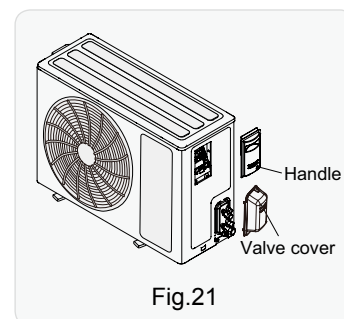
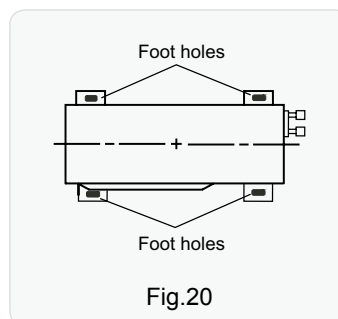

4. Connect Indoor and Outdoor Pipes

- (1) Remove the screw on the right handle of outdoor unit and then remove the handle.(As show in Fig.21)

CAUTION

When there are multiple cables passing through it, the cross-hole of handle should be knocked off and eliminate the sharp burrs for avoid damaging the cables.(For 7K outdoor unit)

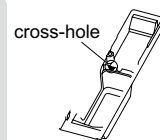

- (2) Remove the screw cap of valve and aim the pipe joint at the bellmouth of pipe.(As show in Fig.22)

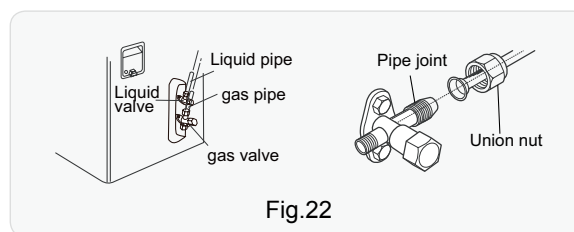

- (3) Pretightening the union nut with hand.
- (4) Tighten the union nut with torque wrench .

Refer to the following table for wrench moment of force:

Piping size	Tightening torque(N·m)
1/4"	15~20
3/8"	30~40
1/2"	45~55
5/8"	60~65
3/4"	70~75

5. Connect Outdoor Electric Wire

(1) Remove the wire clip; connect the power connection wire and signal control wire (only for cooling and heating unit) to the wiring terminal according to the color; fix them with screws.(As show in Fig.23)

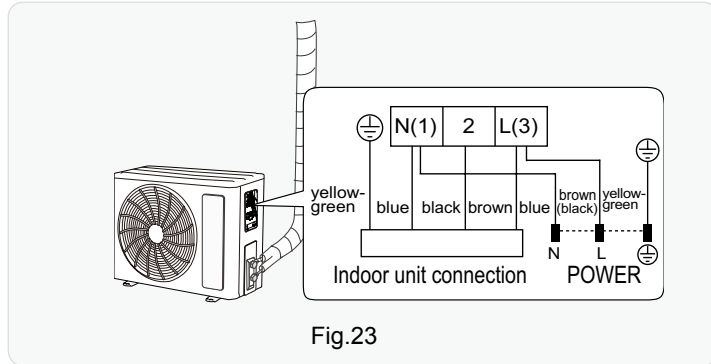

Note: the wiring connect is for reference only, please refer to the actual one.

(2) Fix the power connection wire and signal control wire with wire clip (only for cooling and heating unit).

NOTICE:

- (1) After tightening the screw, pull the power cord slightly to check if it is firm.
- (2) Never cut the power connection wire to prolong or shorten the distance.

6. Neaten the Pipes

- (1) The pipes should be placed along the wall, bent reasonably and hidden possibly. Min. semidiameter of bending the pipe is 10cm.
- (2) If the outdoor unit is higher than the wall hole, you must set a U-shaped curve in the pipe before pipe goes into the room, in order to prevent rain from getting into the room.(As show in Fig.24)

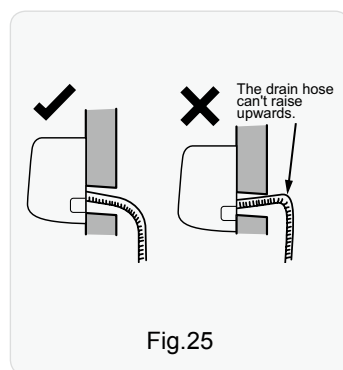
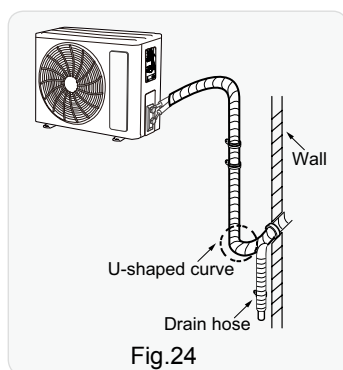

NOTICE:

- (1) The through-wall height of drain hose shouldnt be higher than the outlet pipe hole of indoor unit.(As show in Fig.25)
- (2) Slant the drain hose slightly downwards. The drain hose can't be curved, raised and fluctuant, etc.(As show in Fig.26)
- (3) The water outlet can't be placed in water in order to drain smoothly.(As show in Fig.27)

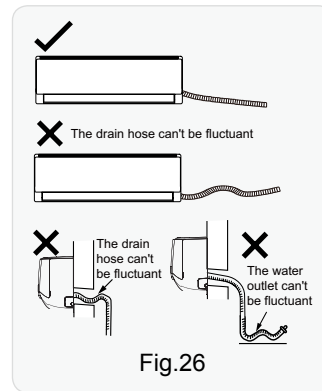

8.7 Vacuum Pumping and Leak Detection

1. Use Vacuum Pump

- (1) Remove the valve caps on the liquid valve and gas valve and the nut of refrigerant charging vent.
- (2) Connect the charging hose of piezometer to the refrigerant charging vent of gas valve and then connect the other charging hose to the vacuum pump.
- (3) Open the piezometer completely and operate for 10-15min to check if the pressure of piezometer remains in -0.1MPa.
- (4) Close the vacuum pump and maintain this status for 1-2min to check if the pressure of piezometer remains in -0.1MPa. If the pressure decreases, there may be leakage.
- (5) Remove the piezometer, open the valve core of liquid valve and gas valve completely with inner hexagon spanner.
- (6) Tighten the screw caps of valves and refrigerant charging vent.(As show in Fig.28)

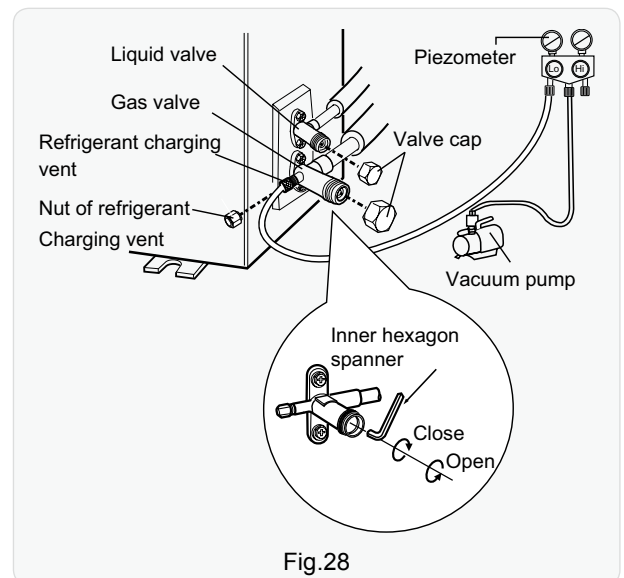

2. Leakage Detection

- (1) With leakage detector: Check if there is leakage with leakage detector.
- (2) With soap water: If leakage detector is not available, please use soap water for leakage detection. Apply soap water at the suspected position and keep the soap water for more than 3min. If there are air bubbles coming out of this position, there's a leakage.

8.8 Check after Installation and Test operation

1. Check after Installation

Check according to the following requirement after finishing installation.

NO.	Items to be checked	Possible malfunction
1	Has the unit been installed firmly?	The unit may drop, shake or emit noise.
2	Have you done the refrigerant leakage test?	It may cause insufficient cooling (heating) capacity.
3	Is heat insulation of pipeline sufficient?	It may cause condensation and water dripping.
4	Is water drained well?	It may cause condensation and water dripping.
5	Is the voltage of power supply according to the voltage marked on the nameplate?	It may cause malfunction or damage the parts.
6	Is electric wiring and pipeline installed correctly?	It may cause malfunction or damage the parts.
7	Is the unit grounded securely?	It may cause electric leakage.
8	Does the power cord follow the specification?	It may cause malfunction or damage the parts.
9	Is there any obstruction in air inlet and air outlet?	It may cause insufficient cooling (heating) capacity.
10	The dust and sundries caused during installation are removed?	It may cause malfunction or damaging the parts.
11	The gas valve and liquid valve of connection pipe are open completely?	It may cause insufficient cooling (heating) capacity.
12	Is the inlet and outlet of piping hole been covered?	It may cause insufficient cooling(heating) capacity or waster eletricity.

2. Test Operation

(1) Preparation of test operation

- The client approves the air conditioner installation.
- Specify the important notes for air conditioner to the client.

(2) Method of test operation

- Put through the power, press ON/OFF button on the remote controller to start operation.
- Press MODE button to select AUTO, COOL, DRY, FAN and HEAT to check whether the operation is normal or not.
- If the ambient temperature is lower than 16°C, the air conditioner can't start cooling.

9. Maintenance

9.1 Error Code List

Malfunction Name	Display Method of Indoor Unit (Error Code)	A/C Status	Possible Causes(For specific maintenance method, please refer to the following procedure of troubleshooting)
High pressure protection of system	E1	Cool/Dry: except indoor fan operates, all loads stop operation. Heat: all loads stops operation.	1. Refrigerant was superabundant; 2. Poor heat exchange (including filth blockage of heat exchanger and bad radiating environment); Ambient temperature is too high.
Anti-freezing protection for evaporator	E2	Cool/Dry: compressor and outdoor fan stop while indoor fan operates.	Not the error code. It's the status code for the operation.
System block or refrigerant leakage	E3	The Dual-8 Code Display will show E3 until the low pressure switch stop operation.	1.Low-pressure protection 2.Low-pressure protection of system 3.Low-pressure protection of compressor
High discharge temperature protection of compressor	E4	Cool/Dry: compressor and outdoor fan stop while indoor fan operates. Heat: all loads stop.	Please refer to the malfunction analysis (discharge protection, overload).
Overcurrent protection	E5	Cool/Dry:compressor and outdoor fan stop while indoor fan operates. Heat: all loads stop.	1. Supply voltage is unstable; 2. Supply voltage is too low and load is too high; 3. Evaporator is dirty.
Communication Malfunction	E6	Cool:compressor stops while indoor fan motor operates. Heat: all loads stops operation.	Refer to the corresponding malfunction analysis.
High temperature resistant protection	E8	Cool: compressor will stop while indoor fan will operate. Heat: all loads stops operation.	Refer to the malfunction analysis (overload, high temperature resistant).
EEPROM malfunction	EE	Cool/Dry:compressor will stop while indoor fan will operate; Heat: all loads stops operation.	Replace outdoor control panel AP1
Limit/decrease frequency due to high temperature of module	EU	All loads operate normally, while operation frequency for compressor is decreased	Discharging after the complete unit is de-energized for 20mins, check whether the thermal grease on IPM Module of outdoor control panel AP1 is sufficient and whether the radiator is inserted tightly. If its no use, please replace control panel AP1.
Malfunction protection of jumper cap	C5	Wireless remote receiver and button are effective, but can not dispose the related command	1. No jumper cap insert on mainboard. 2. Incorrect insert of jumper cap. 3. Jumper cap damaged. 4. Abnormal detecting circuit of mainboard.
Refrigerant insufficient protection	F0	Cool/Dry:compressor and outdoor fan will stop while indoor fan will operate; Heat: all loads stops operation.	1. Is system cooling under high humidity environment, thus temperature difference of heat transfer is small; 2. Check whether the big valve and small valve of outdoor unit are opened completely; 3. Is the temperature sensor of evaporator of indoor unit loose? 4. Is the temperature sensor of condenser of outdoor unit loose? 5. Is the capillary or the electronic expansion valve blocked? 6. Is refrigerant leaking?
Indoor ambient temperature sensor is open/short circuited	F1	Cool/Dry:indoor unit operates while other loads will stop; Heat: all loads stops operation.	1. Loosening or bad contact of indoor ambient temp. sensor and mainboard terminal. 2. Components in mainboard fell down leads short circuit. 3. Indoor ambient temp. sensor damaged.(check with sensor resistance value chart) 4. Mainboard damaged.

Indoor evaporator temperature sensor is open/short circuited	F2	AC stops operation once reaches the setting temperature. Cooling, drying: internal fan motor stops operation while other loads stop operation; heating: AC stop operation	1. Loosening or bad contact of Indoor evaporator temp. sensor and mainboard terminal. 2. Components on the mainboard fall down leads short circuit. 3. Indoor evaporator temp. sensor damaged.(check temp. sensor value chart for testing) 4. Mainboard damaged.
Outdoor ambient temperature sensor is open/short circuited	F3	Cool/Dry: compressor stops while indoor fan operates; Heat: all loads stops operation.	Outdoor temperature sensor hasnt been connected well or is damaged. Please check it by referring to the resistance table for temperature sensor)
Outdoor condenser temperature sensor is open/short circuited	F4	Cool/Dry: compressor stops while indoor fan will operate; Heat: all loads stops operation.	Outdoor temperature sensor hasnt been connected well or is damaged. Please check it by referring to the resistance table for temperature sensor)
Outdoor discharge temperature sensor is open/short circuited	F5	Cool/Dry: compressor will sop after operating for about 3 mins, while indoor fan will operate; Heat: the complete unit will stop after operating for about 3 mins.	1.Outdoor temperature sensor hasnt been connected well or is damaged. Please check it by referring to the resistance table for temperature sensor) 2.The head of temperature sensor hasnt been inserted into the copper tube
Limit/decrease frequency due to overload	F6	All loads operate normally, while operation frequency for compressor is decreased	Refer to the malfunction analysis (overload, high temperature resistant)
Decrease frequency due to overcurrent	F8	All loads operate normally, while operation frequency for compressor is decreased	The input supply voltage is too low; System pressure is too high and overload
Decrease frequency due to high air discharge	F9	All loads operate normally, while operation frequency for compressor is decreased	Overload or temperature is too high; Refrigerant is insufficient; Malfunction of electric expansion valve (EKV)
Limit/decrease frequency due to antifreezing	FH	All loads operate normally, while operation frequency for compressor is decreased	Poor air-return in indoor unit or fan speed is too low
Voltage for DC bus-bar is too high	PH	Cool/Dry: compressor will stop while indoor fan will operate; Heat: all loads stops operation.	1. Measure the voltage of position L and N on wiring board (XT), if the voltage is higher than 265VAC, turn on the unit after the supply voltage is increased to the normal range. 2.If the AC input is normal, measure the voltage of electrolytic capacitor C on control panel (AP1), if its normal, theres malfunction for the circuit, please replace the control panel (AP1)
Voltage of DC bus-bar is too low	PL	Cool/Dry: compressor will stop while indoor fan will operate; Heat: all loads stops operation.	1. Measure the voltage of position L and N on wiring board (XT), if the voltage is higher than 150VAC, turn on the unit after the supply voltage is increased to the normal range. 2.If the AC input is normal, measure the voltage of electrolytic capacitor C on control panel (AP1), if its normal, theres malfunction for the circuit, please replace the control panel (AP1)
Compressor Min frequency in test state	P0		Showing during min. cooling or min. heating test
Compressor rated frequency in test state	P1		Showing during nominal cooling or nominal heating test
Compressor maximum frequency in test state	P2		Showing during max. cooling or max. heating test
Compressor intermediate frequency in test state	P3		Showing during middle cooling or middle heating test
Overcurrent protection of phase current for compressor	P5	Cool/Dry: compressor will stop while indoor fan will operate; Heat: all loads stops operation.	Refer to the malfunction analysis (IPM protection, loss of synchronism protection and overcurrent protection of phase current for compressor.
Charging malfunction of capacitor	PU	Cool/Dry: compressor will stop while indoor fan will operate; Heat: all loads stops operation.	Refer to the part three—charging malfunction analysis of capacitor

Malfunction of module temperature sensor circuit	P7	Cool/Dry: compressor will stop while indoor fan will operate; Heat: all loads stops operation.	Replace outdoor control panel AP1
Module high temperature protection	P8	Cool:compressor will stop while indoor fan will operate; Heat: all loads stops operation.	After the complete unit is de-energized for 20mins, check whether the thermal grease on IPM Module of outdoor control panel AP1 is sufficient and whether the radiator is inserted tightly. If its no use, please replace control panel AP1.
Overload protection for compressor	H3	Cool/Dry: compressor will stop while indoor fan will operate; Heat: all loads stops operation.	1. Wiring terminal OVC-COMP is loosened. In normal state, the resistance for this terminal should be less than 1ohm. 2.Refer to the malfunction analysis (discharge protection, overload)
IPM protection	H5	Cool/Dry: compressor will stop while indoor fan will operate; Heat: all loads stops operation.	Refer to the malfunction analysis (IPM protection, loss of synchronism protection and overcurrent protection of phase current for compressor.
Malfunction of zero-cross detection circuit	U8	All loads stops operation.	1.Power supply is abnormal; 2.Detection circuit of indoor control mainboard is abnormal.
Internal motor (fan motor) do not operate	H6	Internal fan motor, external fan motor, compressor and electric heater stop operation,guide louver stops at present location.	1. Bad contact of DC motor feedback terminal. 2. Bad contact of DC motor control end. 3. Fan motor is stalling. 4. Motor malfunction. 5. Malfunction of mainboard revdetecting circuit.
Desynchro-nizing of compressor	H7	Cool/Dry: compressor will stop while indoor fan will operate; Heat: all loads stops operation.	Refer to the malfunction analysis (IPM protection, loss of synchronism protection and overcurrent protection of phase current for compressor.
PFC protection	HC	Cool/Dry: compressor will stop while indoor fan will operate; Heat: all loads stops operation.	Refer to the malfunction analysis
Outdoor DC fan motor malfunction	L3	Outdoor DC fan motor malfunction lead to compressor stop operation,	DC fan motor malfunction or system blocked or the connector loosed
power protection	L9	compressor stop operation and Outdoor fan motor will stop 30s latter , 3 minutes latter fan motor and compressor will restart	To protect the electronical components when detect high power
Indoor unit and outdoor unit doesnt match	LP	compressor and Outdoor fan motor can't work	Indoor unit and outdoor unit doesnt match
Failure start-up	LC	Cool/Dry: compressor will stop while indoor fan will operate; Heat: all loads stops operation.	Refer to the malfunction analysis
Defrosting	Heating indicator off for 0.5s and then blinks for 10s	Defrosting will occur in heating mode. Compressor will operate while indoor fan will stop operation.	Not the error code. It's the status code for the operation
The four-way valve is abnormal	U7	If this malfunction occurs in heating mode, all loads stop	1.Supply voltage is lower than AC175V; 2.Wiring terminal 4V is loosened or broken; 3.4V is damaged, please replace 4V.
Malfunction of phase current detection circuit for compressor	U1	Cool/Dry: compressor will stop while indoor fan will operate; Heat: all loads stops operation.	Replace outdoor control panel AP1

Malfunction of voltage dropping for DC busbar	U3	Cool/Dry: compressor will stop while indoor fan will operate; Heat: all loads stops operation.	Supply voltage is unstable
Malfunction of complete units current detection	U5	Cool/Dry: the compressor will stop while indoor fan will operate; Heat: all loads stops operation.	Theres circuit malfunction on outdoor units control panel AP1, please replace the outdoor units control panel AP1.
Cold air prevention protection	E9		Not the error code. It's the status code for the operation.
Refrigerant recovery mode	Fo	Cool/Dry: compressor and outdoor fan stops operation, while indoor fan operates.	Refrigerant recovery. The maintenance personnel operate it when he is maintaining the unit.
Undefined outdoor unit error	oE	Cool: compressor and outdoor fan stops operation, while indoor fan operates; Heat: compressor, outdoor fan and indoor fan stop operation.	1. Outdoor ambient temperature exceeds the operation range of unit (eg: less than -20°C or more than 60°C for cooling; more than 30°C for heating); 2. Failure startup of compressor? 3. Are wires of compressor not connected tightly? 4. Is compressor damaged? 5. Is main board damaged?
Malfunction of detecting plate(WIFI)	JF	Loads operate normally, while the unit can't be normally controlled by APP.	1. Main board of indoor unit is damaged; 2. Detection board is damaged; 3. The connection between indoor unit and detection board is not good;

Analysis or processing of some of the malfunction display:

1. Compressor discharge protection

Possible causes: shortage of refrigerant; blockage of air filter; poor ventilation or air flow short pass for condenser; the system has noncondensing gas (such as air, water etc.); blockage of capillary assy (including filter); leakage inside four-way valve causes incorrect operation; malfunction of compressor; malfunction of protection relay; malfunction of discharge sensor; outdoor temperature too high.

Processing method: refer to the malfunction analysis in the above section.

2. Low voltage overcurrent protection

Possible cause: Sudden drop of supply voltage.

3. Communication malfunction

Processing method: Check if communication signal cable is connected reliably.

4. Sensor open or short circuit

Processing method: Check whether sensor is normal, connected with the corresponding position on the controller and if damage of lead wire is found.

5. Compressor over load protection

Possible causes: insufficient or too much refrigerant; blockage of capillary and increase of suction temp.; improper running of compressor, burning in or stuck of bearing, damage of discharge valve; malfunction of protector.

Processing method: adjust refrigerant amount; replace the capillary; replace the compressor; use universal meter to check if the contactor of compress or is fine when it is not overheated, if not replace the protector.

6. System malfunction

i.e. overload protection. When tube temperature (Check the temperature of outdoor heat exchanger when cooling and check the temperature of indoor heat exchanger when heating) is too high, protection will be activated.

Possible causes: Outdoor temperature is too high when cooling; insufficient outdoor air circulation; refrigerant flow malfunction.

please refer to the malfunction analysis in the previous section for handling method .

7. IPM module protection

Processing method: Once the module malfunction happens, if it persists for a long time and can not be selfcanceled, cut off the power and turn off the unit, and then re-energize the unit again after about 10 min. After repeating the procedure for sever times, if the malfunction still exists, replace the module.

If malfunction occurs, corresponding code will display and the unit will resume normal until protection or malfunction disappears.

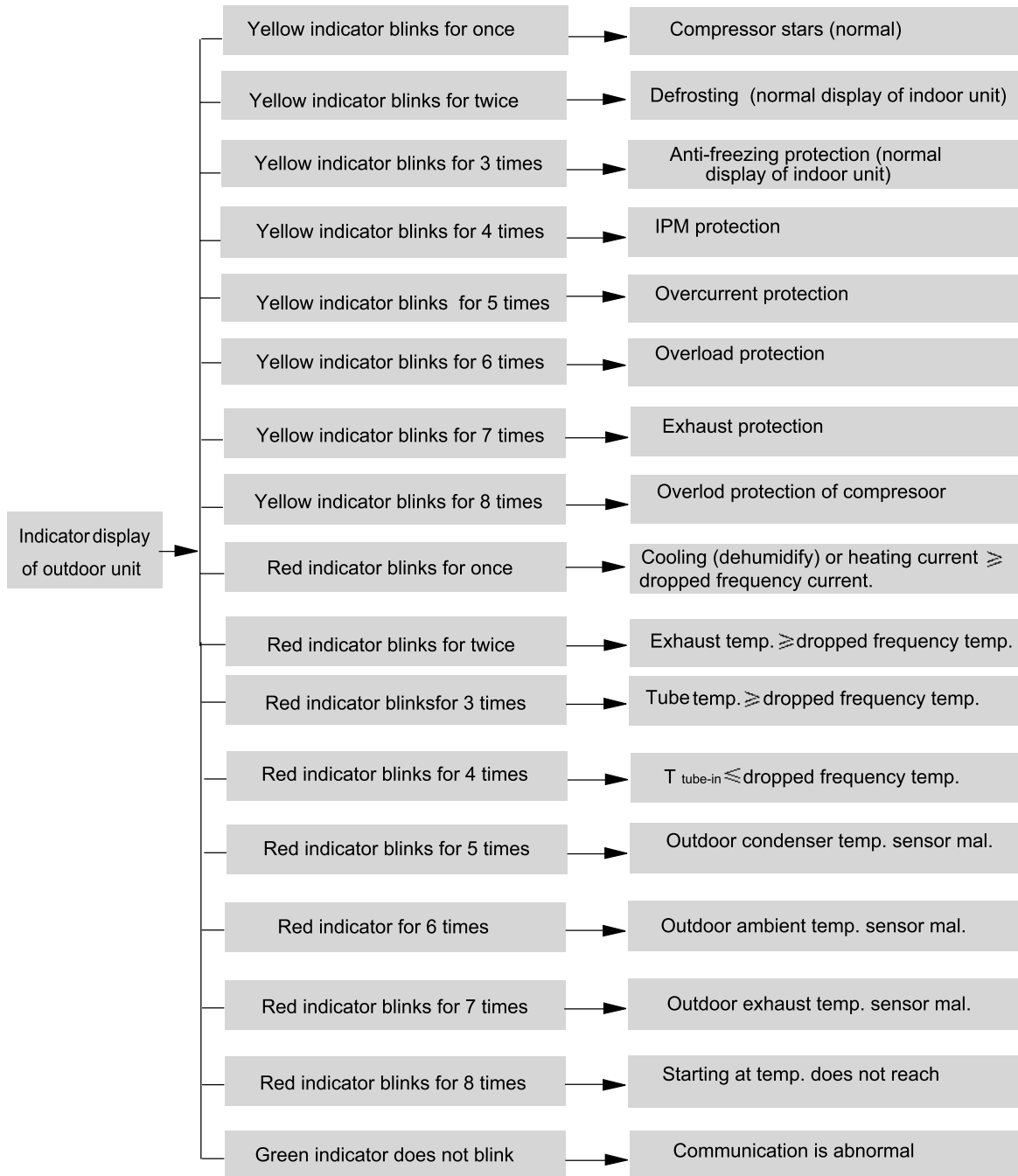

9.2 Procedure of Troubleshooting

●Indoor unit:

1. Malfunction of Temperature Sensor F1, F2

Main detection points:

- Is the wiring terminal between the temperature sensor and the controller loosened or poorly contacted?
- Is there short circuit due to trip-over of the parts?
- Is the temperature sensor broken?
- Is mainboard broken?

Malfunction diagnosis process:

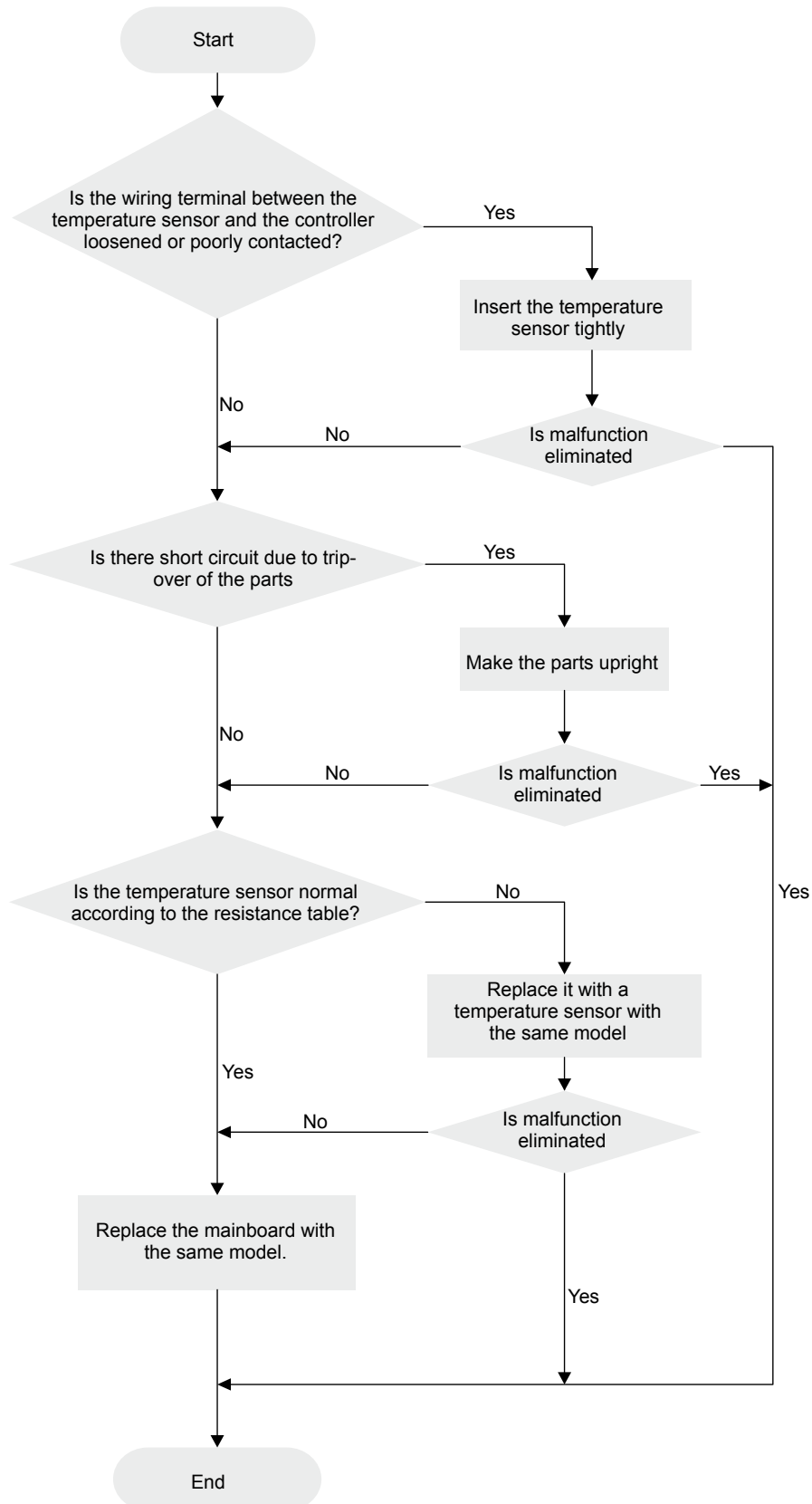

2. Malfunction of Blocked Protection of IDU Fan Motor H6

Main detection points:

- Smoothly is the terminal of motor connected tightly?
- The fan motor can't operate?
- The motor is broken?
- Detection circuit of the mainboard is defined abnormal?

Malfunction diagnosis process:

2.1 PG motor

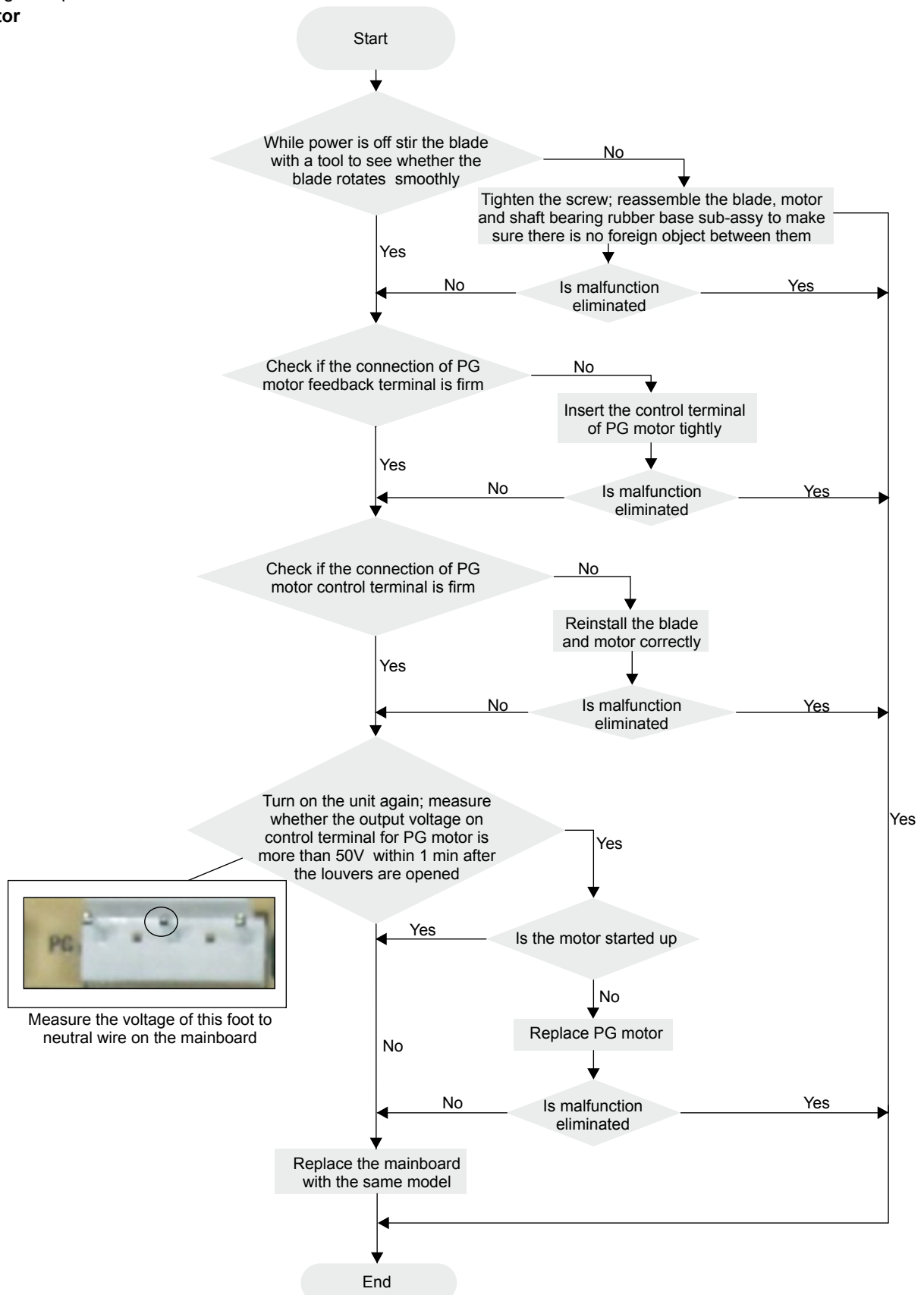

2.2 DC motor

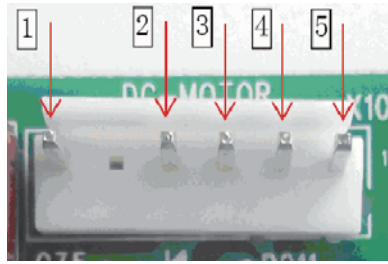
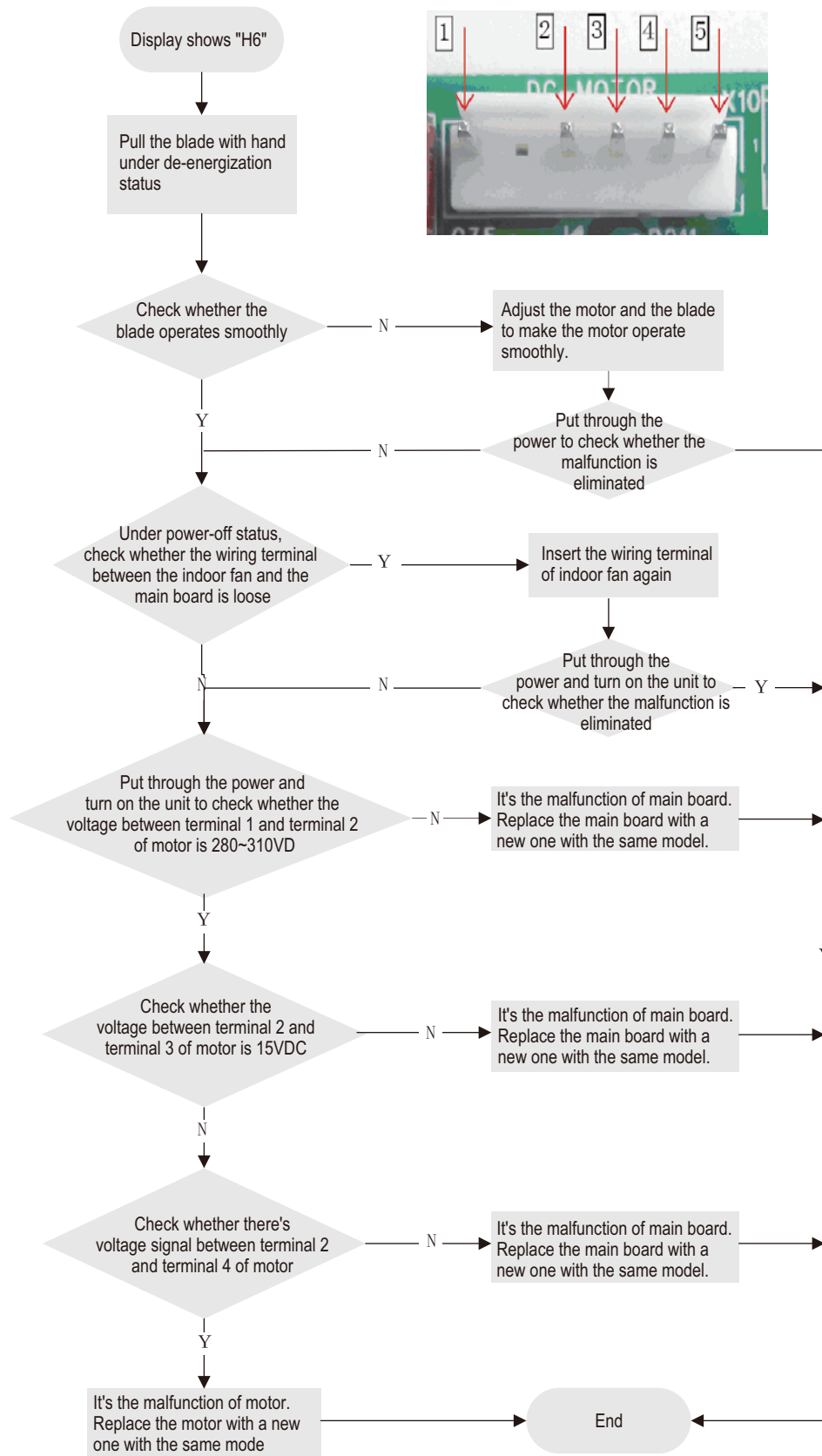

3. Malfunction of Protection of Jumper Cap C5

Main detection points:

- Is there jumper cap on the mainboard?
- Is the jumper cap inserted correctly and tightly?
- The jumper is broken?
- The motor is broken?
- Detection circuit of the mainboard is defined abnormal?

Malfunction diagnosis process:

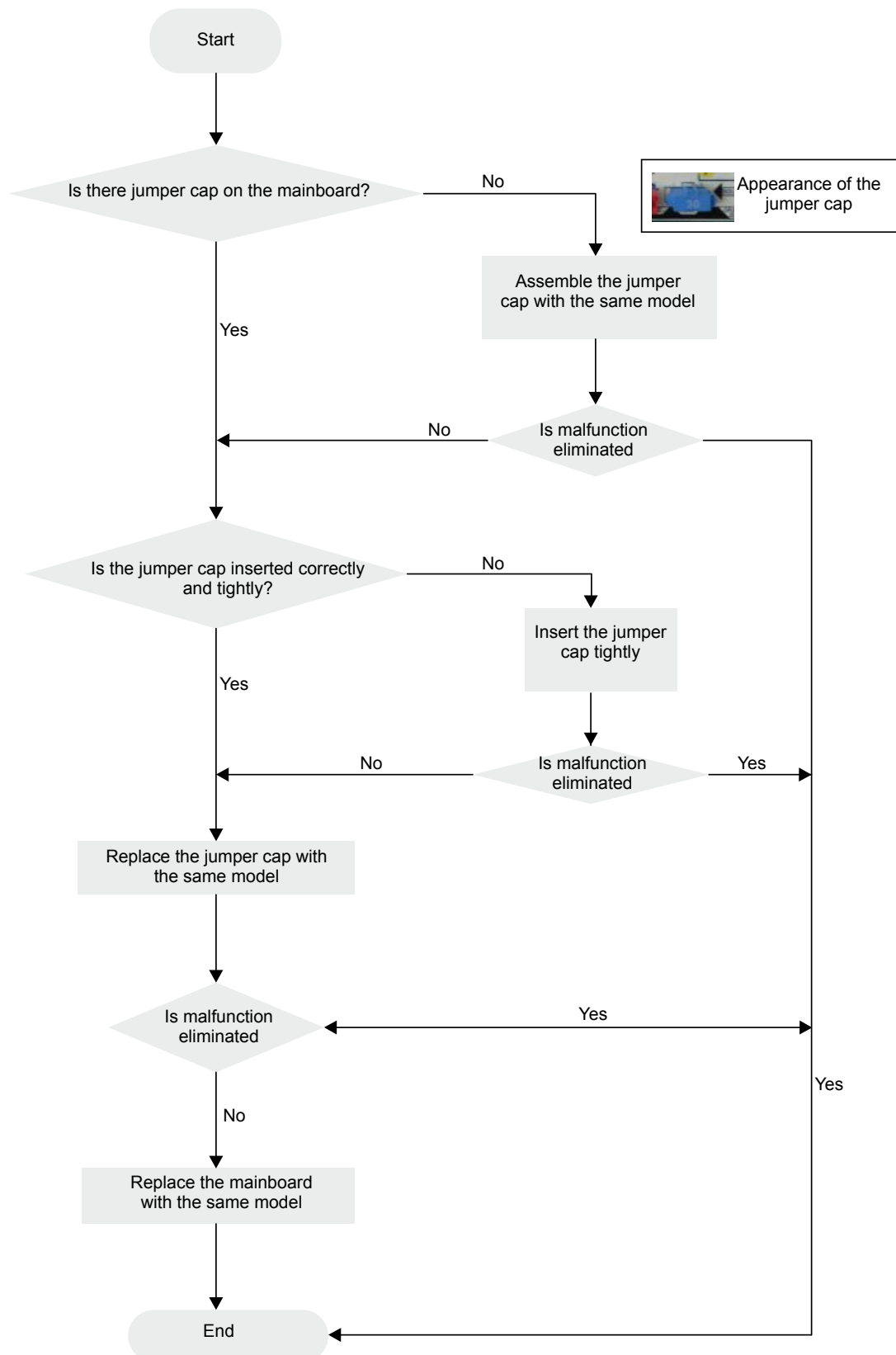

5. High Temperature and Overload Protection (AP1 below means control board of outdoor unit) E8

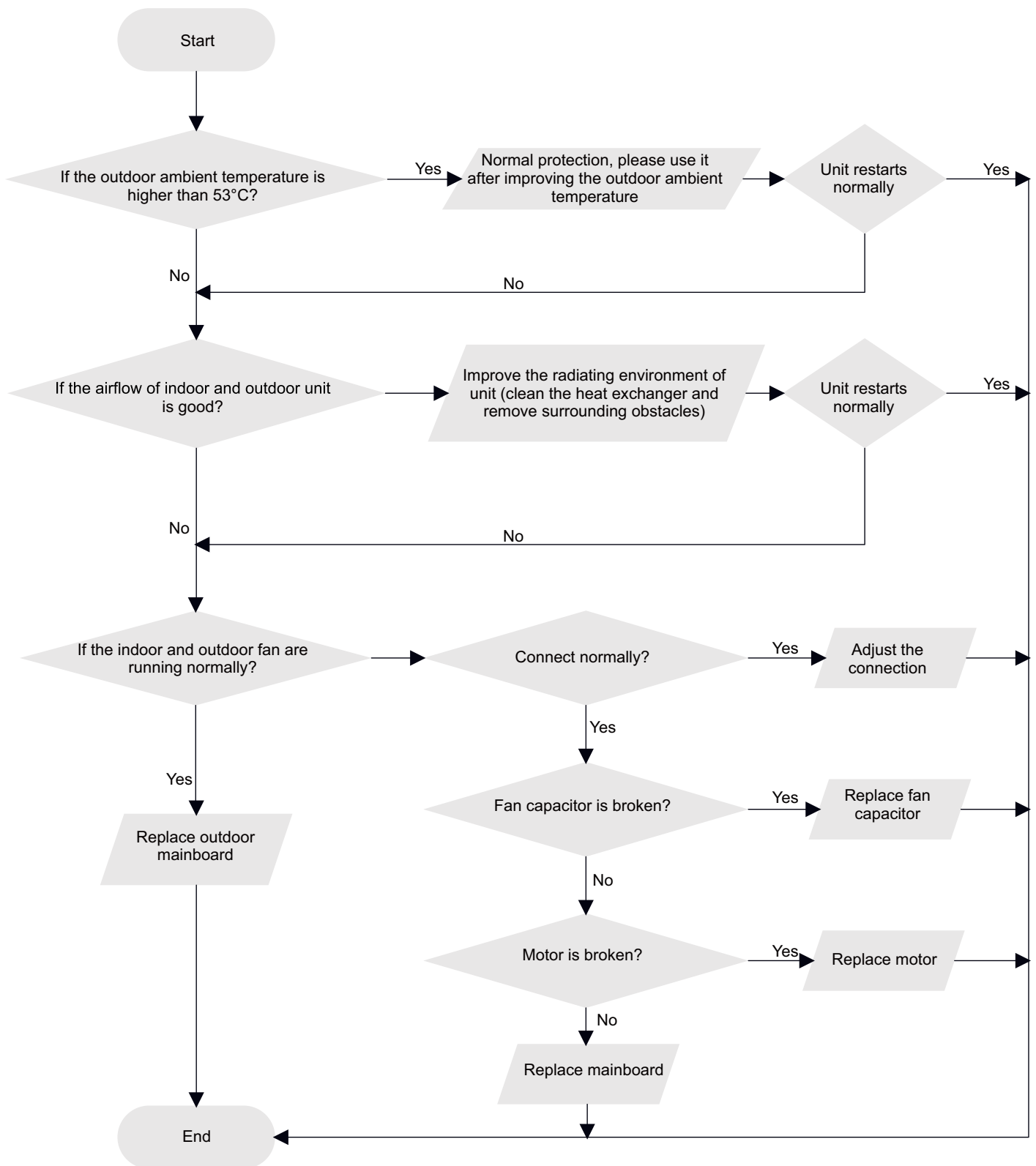

6. Malfunction of detecting plate(WIFI) JF

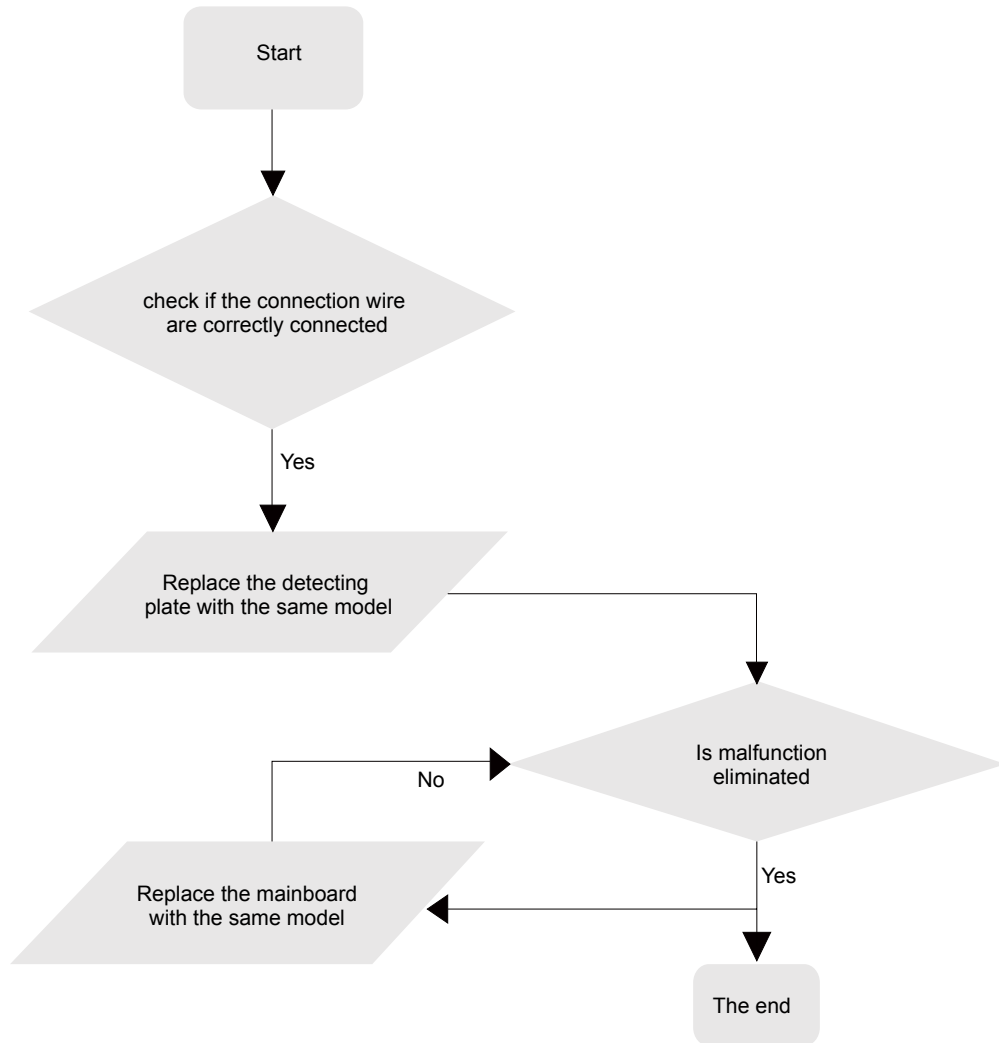

●Outdoor unit:

1.Capacity charging malfunction (outdoor unit malfunction) (AP1 below is control board of outdoor unit)

Main detection point:

- Detect if the voltage of L and N terminal of wiring board is between 210AC-240AC by alternating voltage meter;
- Is reactor (L) well connected? Is connection wire loosened or pull-out? Is reactor (L) damaged?

Malfunction diagnosis process:

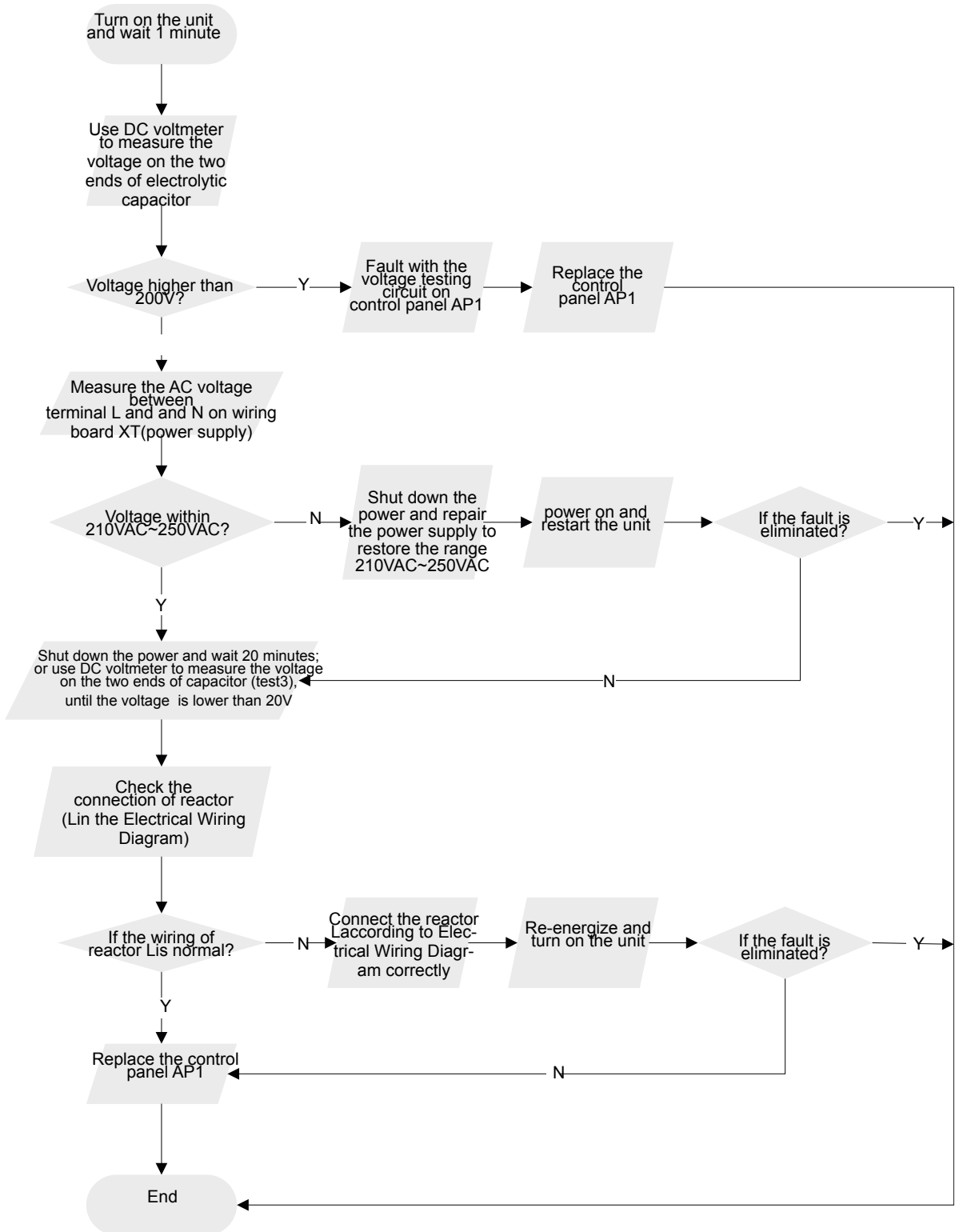

2.Diagnosis for anti-high temperature, overload protection (AP1 below is control board of outdoor unit)

Main detection point:

- If the outdoor ambient temperature is in normal range;
- If the indoor and outdoor fan is running normal;
- If the radiating environment of indoor and outdoor unit is well.

Malfunction diagnosis process:

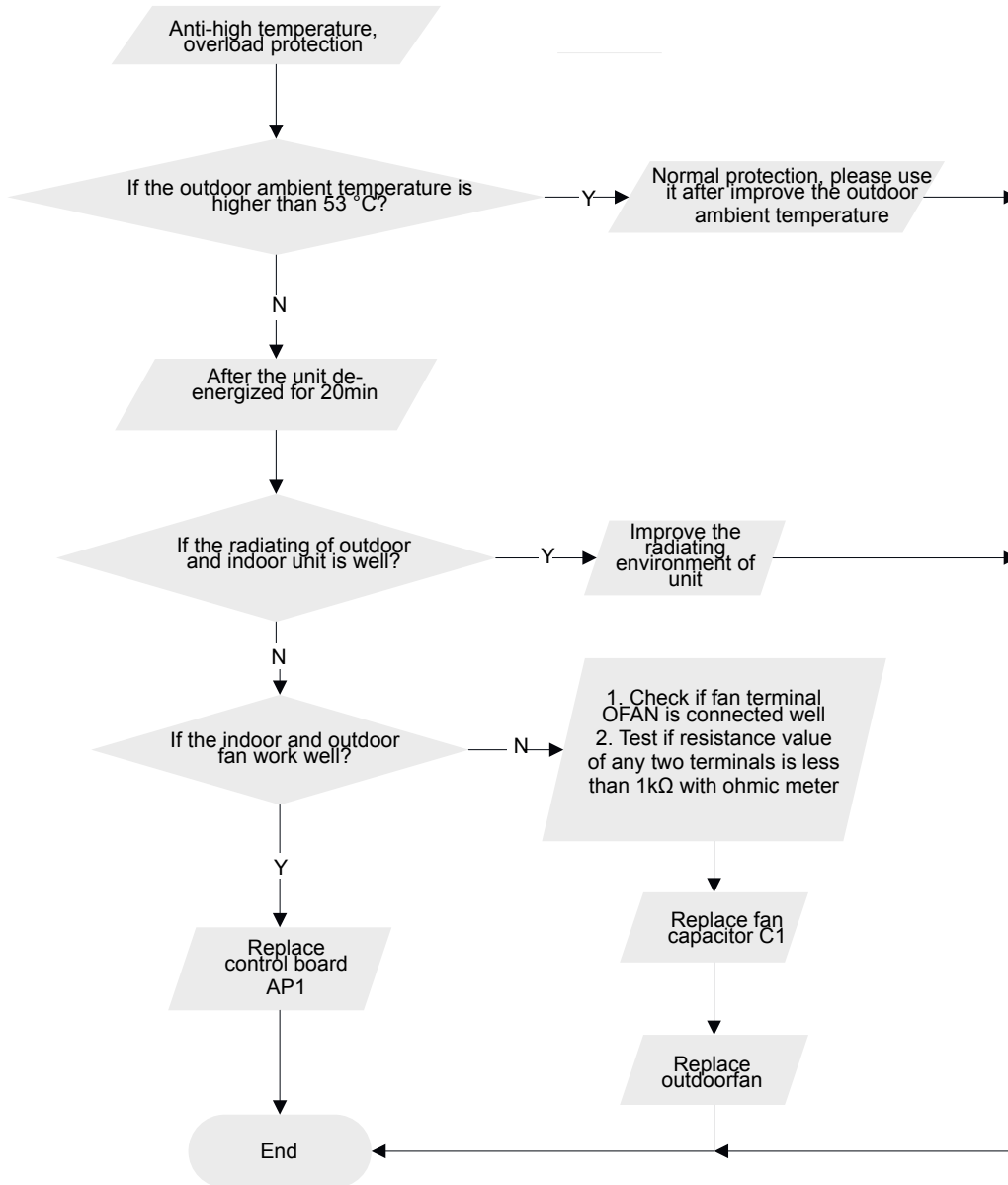

3. IPM protection, phase current overcurrent (the control board as below indicates the control board of outdoor unit) H5/P5

Mainly detect:

- (1) Compressor COMP terminal
- (2) voltage of power supply
- (3) compressor
- (4) Refrigerant-charging volume
- (5) air outlet and air inlet of outdoor/indoor unit

Troubleshooting:

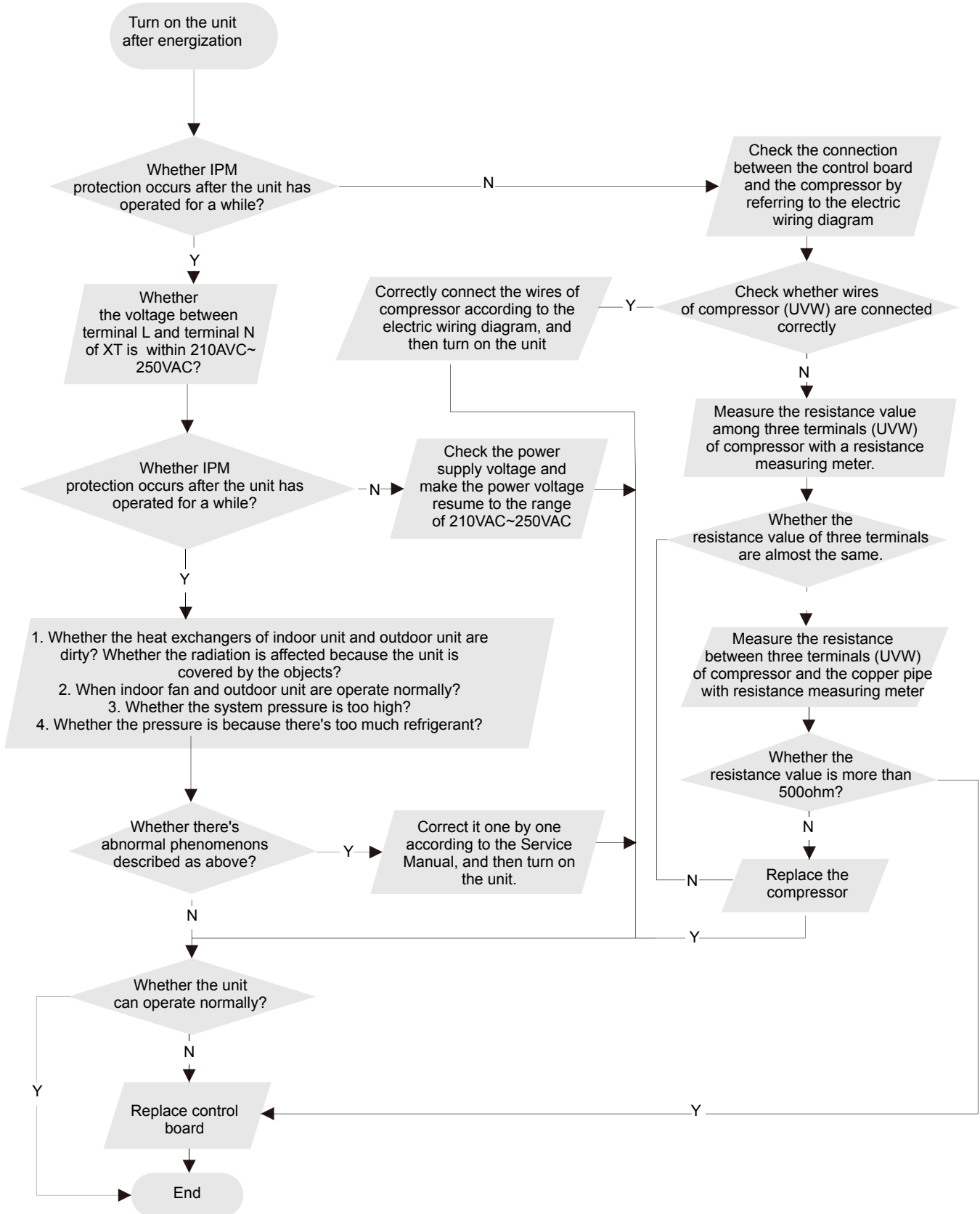

5. Out of step diagnosis for the compressor (AP1 hereinafter refers to the control board of the outdoor unit)

Mainly detect:

- Is the system pressure too high?
- Is the input voltage too low?

Fault diagnosis process:

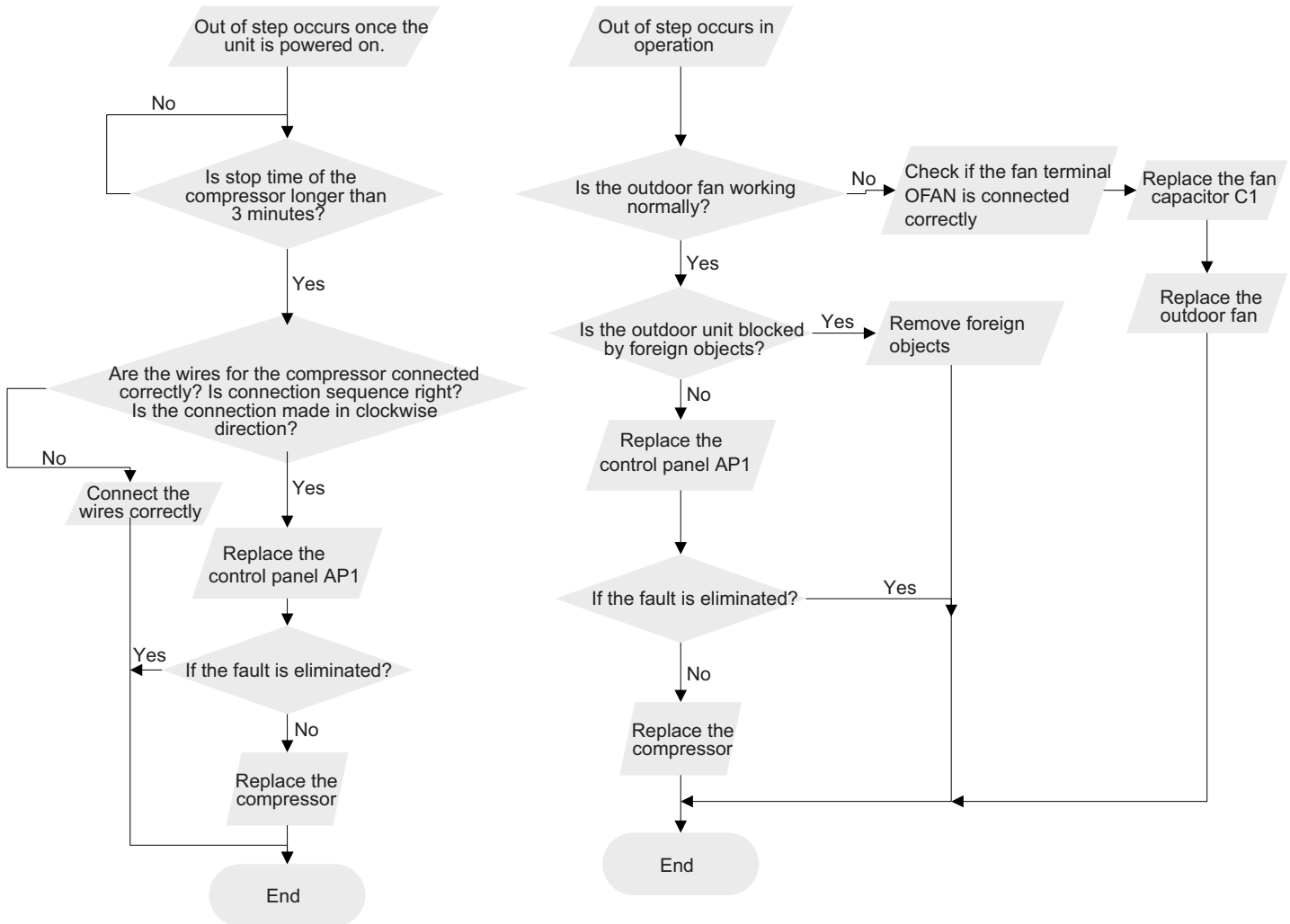

6. Overload and air exhaust malfunction diagnosis (following AP1 for outdoor unit control board)

Mainly detect:

- Is the PMV connected well or not? Is PMV damaged?
- Is refrigerant leaked?

Fault diagnosis process:

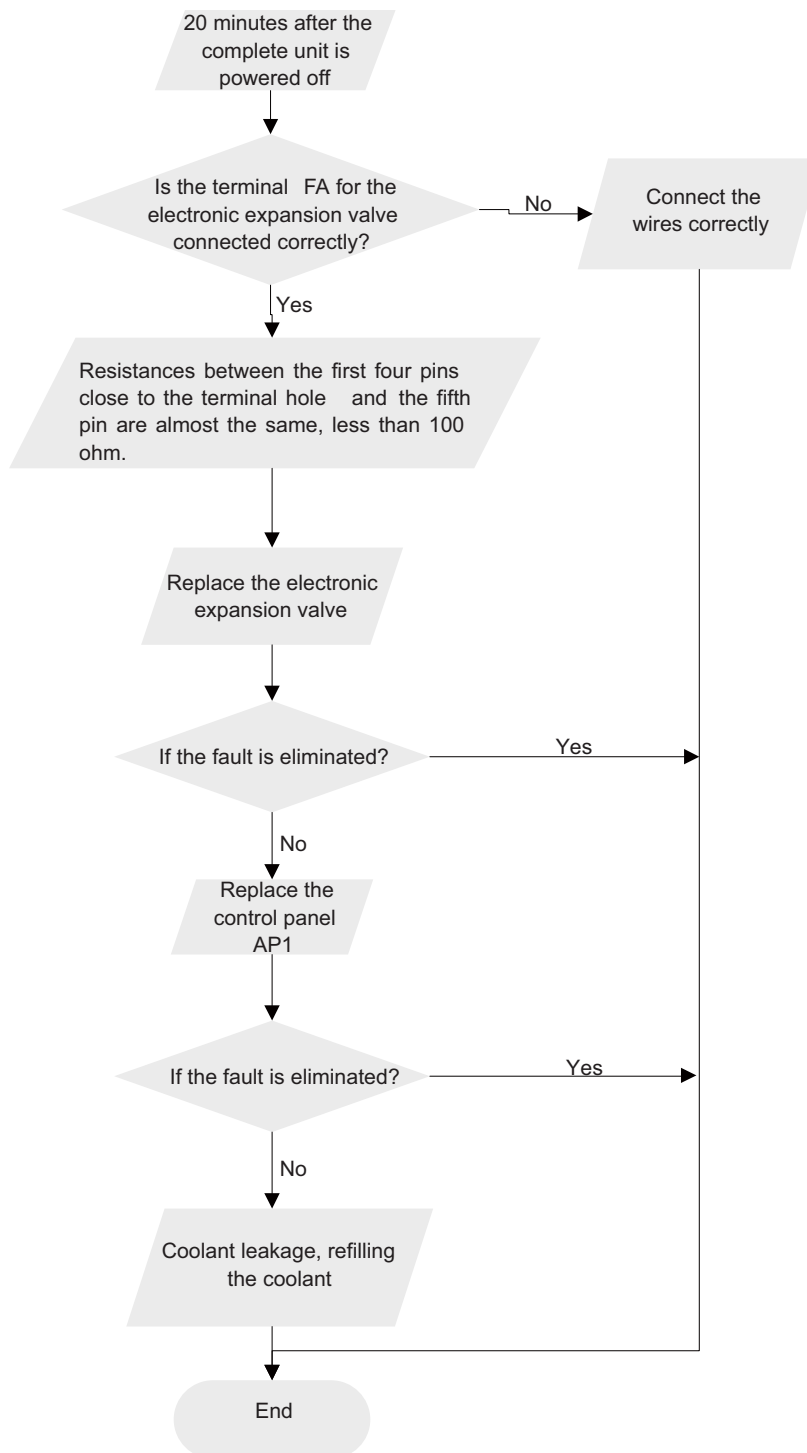

7. Communication malfunction: (following AP1 for outdoor unit control board)

Mainly detect:

- Is there any damage for the indoor unit mainboard communication circuit? Is communication circuit damaged?
- Detect the indoor and outdoor units connection wire and indoor and outdoor units inside wiring is connect well or not, if is there any damage?

Fault diagnosis process:

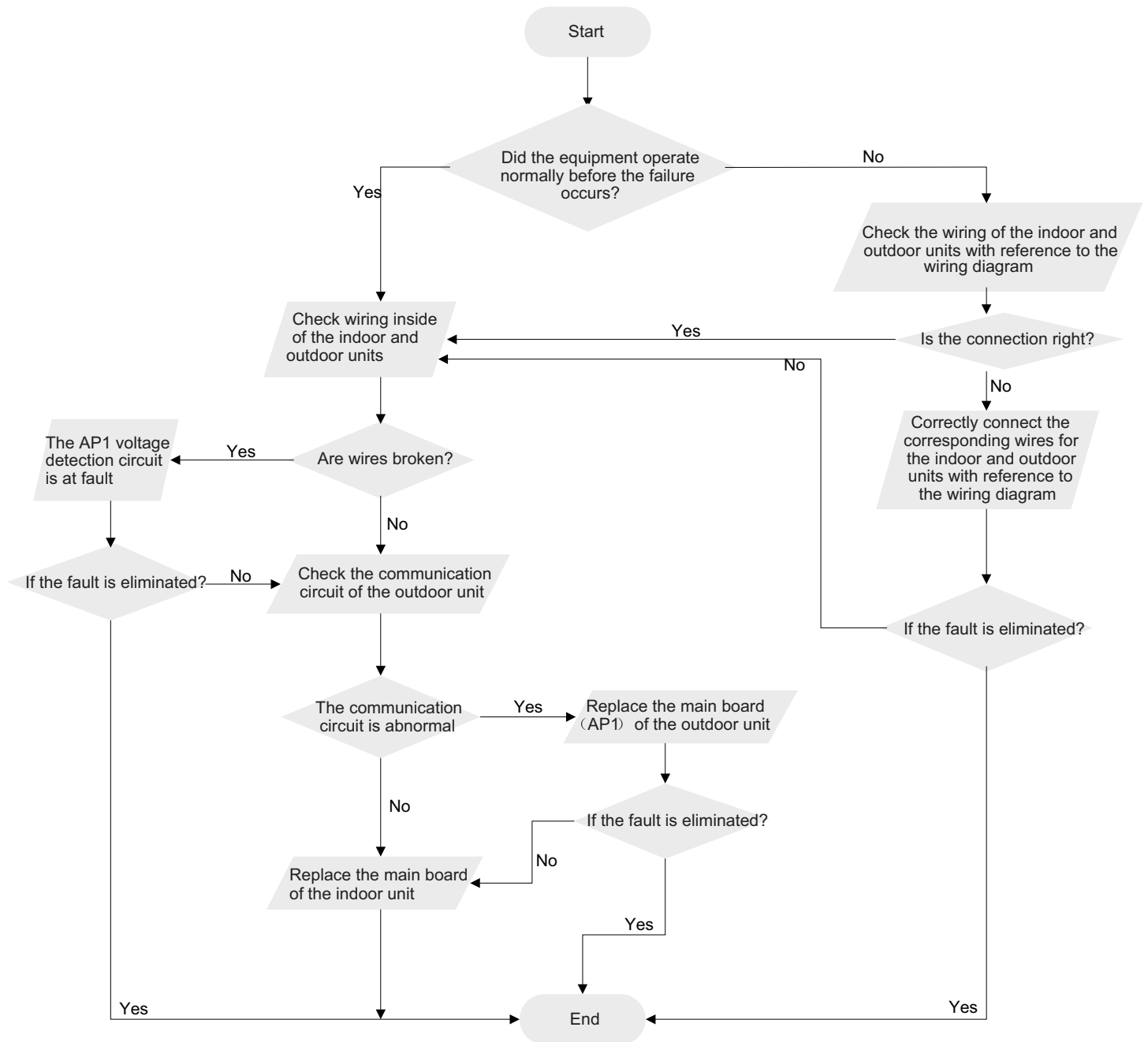

8. Malfunction of Overcurrent Protection

Main detection points:

- Is the supply voltage unstable with big fluctuation?
- Is the supply voltage too low with overload?
- Hardware trouble?

Malfunction diagnosis process:

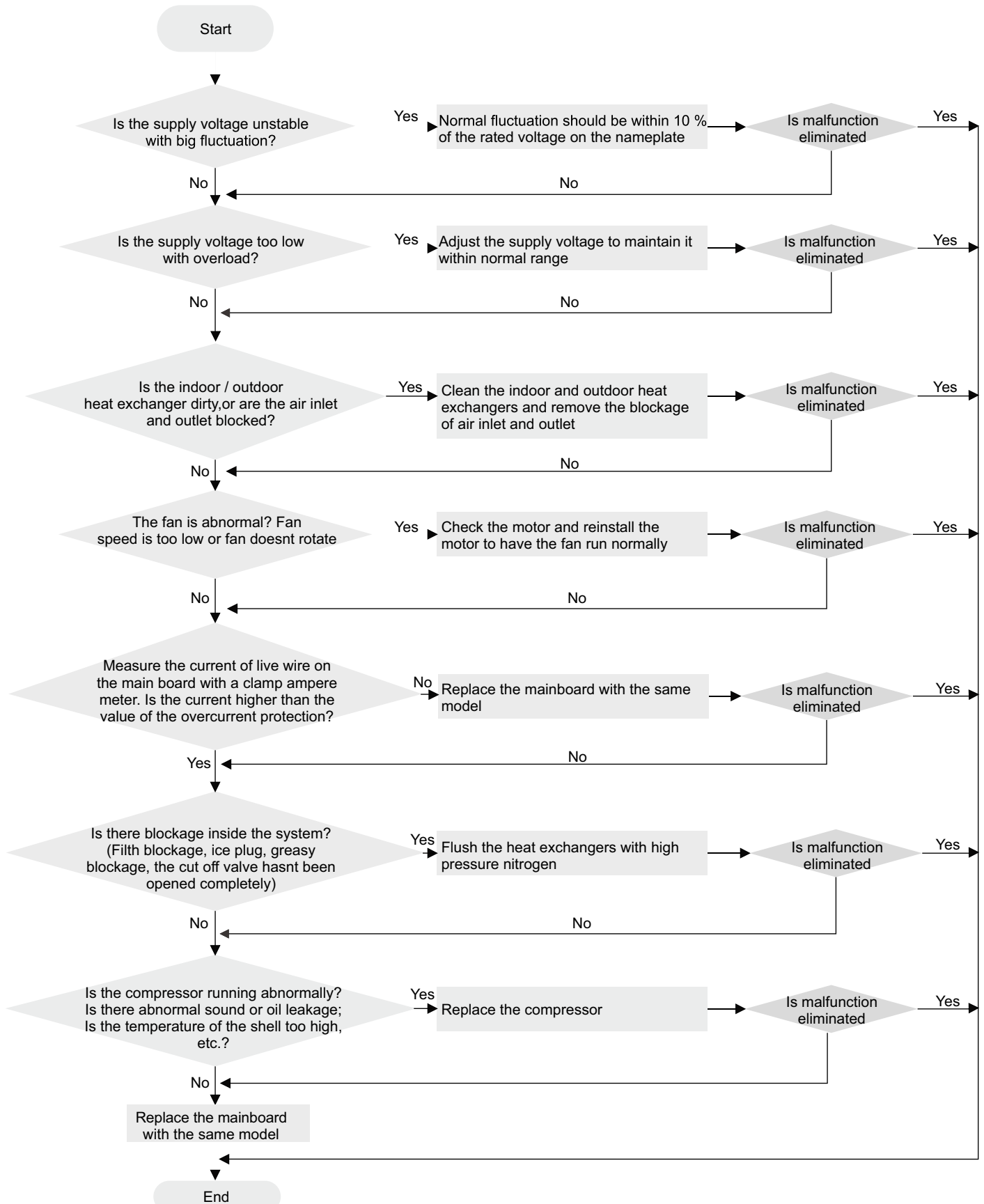

9.3 Troubleshooting for Normal Malfunction

1. Air Conditioner Can't be Started Up

Possible Causes	Discriminating Method (Air conditioner Status)	Troubleshooting
No power supply, or poor connection for power plug	After energization, operation indicator isn't bright and the buzzer can't give out sound	Confirm whether it's due to power failure. If yes, wait for power recovery. If not, check power supply circuit and make sure the power plug is connected well.
Wrong wire connection between indoor unit and outdoor unit, or poor connection for wiring terminals	Under normal power supply circumstances, operation indicator isn't bright after energization	Check the circuit according to circuit diagram and connect wires correctly. Make sure all wiring terminals are connected firmly
Electric leakage for air conditioner	After energization, room circuit breaker trips off at once	Make sure the air conditioner is grounded reliably Make sure wires of air conditioner are connected correctly Check the wiring inside air conditioner. Check whether the insulation layer of power cord is damaged; if yes, place the power cord.
Model selection for air switch is improper	After energization, air switch trips off	Select proper air switch
Malfunction of remote controller	After energization, operation indicator is bright, while no display on remote controller or buttons have no action.	Replace batteries for remote controller Repair or replace remote controller

2. Poor Cooling (Heating) for Air Conditioner

Possible Causes	Discriminating Method (Air conditioner Status)	Troubleshooting
Set temperature is improper	Observe the set temperature on remote controller	Adjust the set temperature
Rotation speed of the IDU fan motor is set too low	Small wind blow	Set the fan speed at high or medium
Filter of indoor unit is blocked	Check the filter to see if it's blocked	Clean the filter
Installation position for indoor unit and outdoor unit is improper	Check whether the installation position is proper according to installation requirement for air conditioner	Adjust the installation position, and install the rainproof and sunproof for outdoor unit
Refrigerant is leaking	Discharged air temperature during cooling is higher than normal discharged wind temperature; Discharged air temperature during heating is lower than normal discharged wind temperature; Units pressure is much lower than regulated range	Find out the leakage causes and deal with it. Add refrigerant.
Malfunction of 4-way valve	Blow cold wind during heating	Replace the 4-way valve
Malfunction of capillary	Discharged air temperature during cooling is higher than normal discharged wind temperature; Discharged air temperature during heating is lower than normal discharged wind temperature; Unit pressure is much lower than regulated range. If refrigerant isn't leaking, part of capillary is blocked	Replace the capillary
Flow volume of valve is insufficient	The pressure of valves is much lower than that stated in the specification	Open the valve completely
Malfunction of horizontal louver	Horizontal louver can't swing	Refer to point 3 of maintenance method for details
Malfunction of the IDU fan motor	The IDU fan motor can't operate	Refer to troubleshooting for H6 for maintenance method in details
Malfunction of the ODU fan motor	The ODU fan motor can't operate	Refer to point 4 of maintenance method for details
Malfunction of compressor	Compressor can't operate	Refer to point 5 of maintenance method for details

3. Horizontal Louver Can't Swing

Possible Causes	Discriminating Method (Air conditioner Status)	Troubleshooting
Wrong wire connection, or poor connection	Check the wiring status according to circuit diagram	Connect wires according to wiring diagram to make sure all wiring terminals are connected firmly
Stepping motor is damaged	Stepping motor can't operate	Repair or replace stepping motor
Main board is damaged	Others are all normal, while horizontal louver can't operate	Replace the main board with the same model

4. ODU Fan Motor Can't Operate

Possible causes	Discriminating method (air conditioner status)	Troubleshooting
Wrong wire connection, or poor connection	Check the wiring status according to circuit diagram	Connect wires according to wiring diagram to make sure all wiring terminals are connected firmly
Capacity of the ODU fan motor is damaged	Measure the capacity of fan capacitor with an universal meter and find that the capacity is out of the deviation range indicated on the nameplate of fan capacitor.	Replace the capacity of fan
Power voltage is a little low or high	Use universal meter to measure the power supply voltage. The voltage is a little high or low	Suggest to equip with voltage regulator
Motor of outdoor unit is damaged	When unit is on, cooling/heating performance is bad and ODU compressor generates a lot of noise and heat.	Change compressor oil and refrigerant. If no better, replace the compressor with a new one

5. Compressor Can't Operate

Possible causes	Discriminating method (air conditioner status)	Troubleshooting
Wrong wire connection, or poor connection	Check the wiring status according to circuit diagram	Connect wires according to wiring diagram to make sure all wiring terminals are connected firmly
Capacity of compressor is damaged	Measure the capacity of fan capacitor with an universal meter and find that the capacity is out of the deviation range indicated on the nameplate of fan capacitor.	Replace the compressor capacitor
Power voltage is a little low or high	Use universal meter to measure the power supply voltage. The voltage is a little high or low	Suggest to equip with voltage regulator
Coil of compressor is burnt out	Use universal meter to measure the resistance between compressor terminals and it's 0	Repair or replace compressor
Cylinder of compressor is blocked	Compressor can't operate	Repair or replace compressor

6. Air Conditioner is Leaking

Possible causes	Discriminating method (air conditioner status)	Troubleshooting
Drain pipe is blocked	Water leaking from indoor unit	Eliminate the foreign objects inside the drain pipe
Drain pipe is broken	Water leaking from drain pipe	Replace drain pipe
Wrapping is not tight	Water leaking from the pipe connection place of indoor unit	Wrap it again and bundle it tightly

7. Abnormal Sound and Vibration

Possible causes	Discriminating method (air conditioner status)	Troubleshooting
When turn on or turn off the unit, the panel and other parts will expand and theres abnormal sound	Theres the sound of "PAPA"	Normal phenomenon. Abnormal sound will disappear after a few minutes.
When turn on or turn off the unit, theres abnormal sound due to flow of refrigerant inside air conditioner	Water-running sound can be heard	Normal phenomenon. Abnormal sound will disappear after a few minutes.
Foreign objects inside the indoor unit or therere parts touching together inside the indoor unit	Theres abnormal sound fro indoor unit	Remove foreign objects. Adjust all parts position of indoor unit, tighten screws and stick damping plaster between connected parts
Foreign objects inside the outdoor unit or therere parts touching together inside the outdoor unit	Theres abnormal sound fro outdoor unit	Remove foreign objects. Adjust all parts position of outdoor unit, tighten screws and stick damping plaster between connected parts
Short circuit inside the magnetic coil	During heating, the way valve has abnormal electromagnetic sound	Replace magnetic coil
Abnormal shake of compressor	Outdoor unit gives out abnormal sound	Adjust the support foot mat of compressor, tighten the bolts
Abnormal sound inside the compressor	Abnormal sound inside the compressor	If add too much refrigerant during maintenance, please reduce refrigerant properly. Replace compressor for other circumstances.

10. Exploded View and Parts List

10.1 Indoor Unit

7/9K

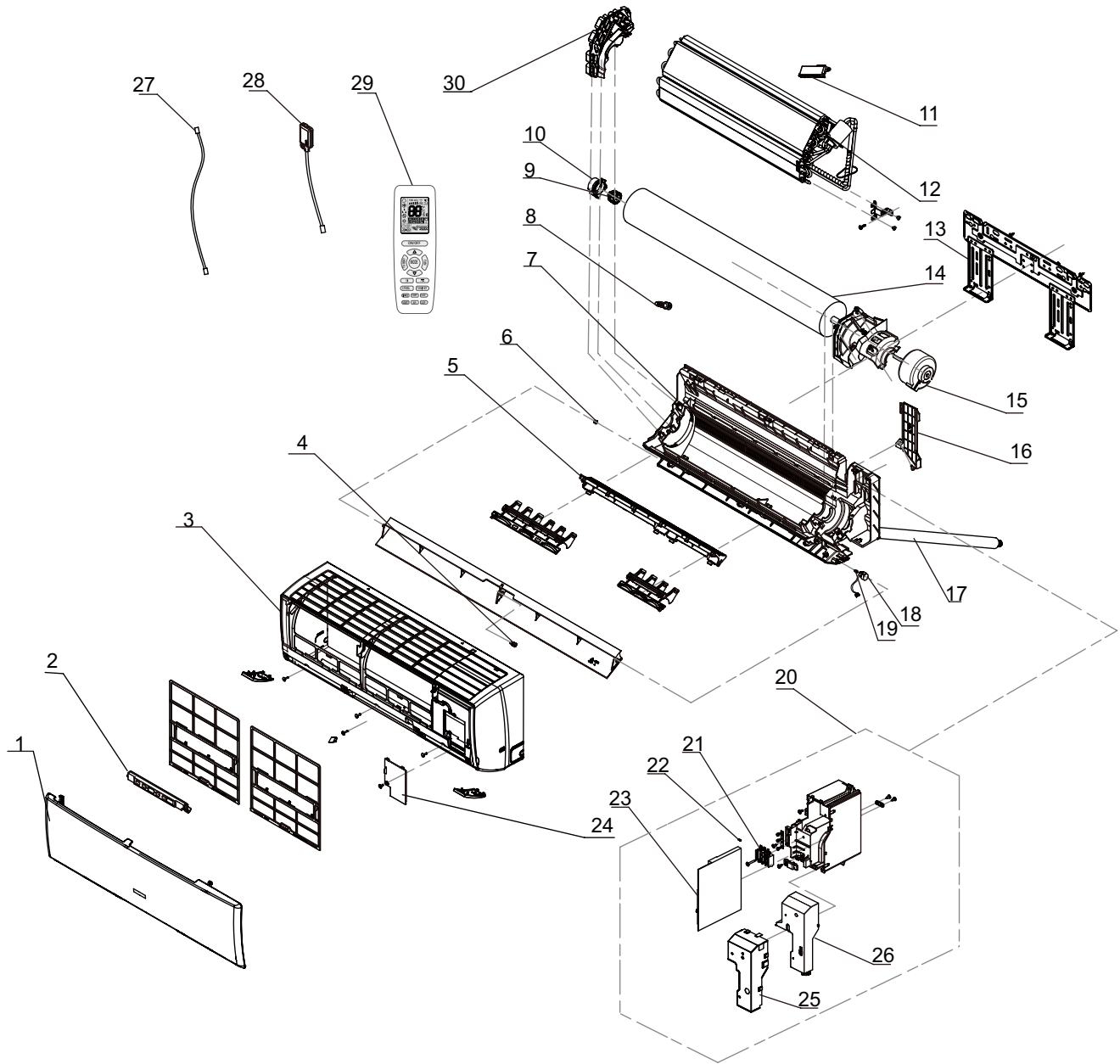

The component picture is only for reference; please refer to the actual product.

NO.	Description
1	Front Panel Assy
2	Display Board
3	Front Case Assy
4	Axile Bush
5	Helicoid Tongue
6	Left Axile Bush
7	Rear Case assy
8	Rubber Plug (Water Tray)
9	O-Gasket sub-assy of Bearing
10	Ring of Bearing
11	Cold Plasma Generator
12	Evaporator Assy
13	Wall Mounting Frame
14	Cross Flow Fan
15	Fan Motor
16	Connecting pipe clamp
17	Drainage Hose
18	Stepping Motor
19	Crank
20	Electric Box Assy
21	Terminal Board
22	Jumper
23	Main Board
24	Electric Box Cover Sub-Assy
25	Shield Cover of Electric Box Cover
26	Electric Box Cover
27	Connecting Cable
28	Detecting Plate
29	Remote Controller
30	Evaporator Support

Some models may not contain some parts, please refer to the actual product.

12K

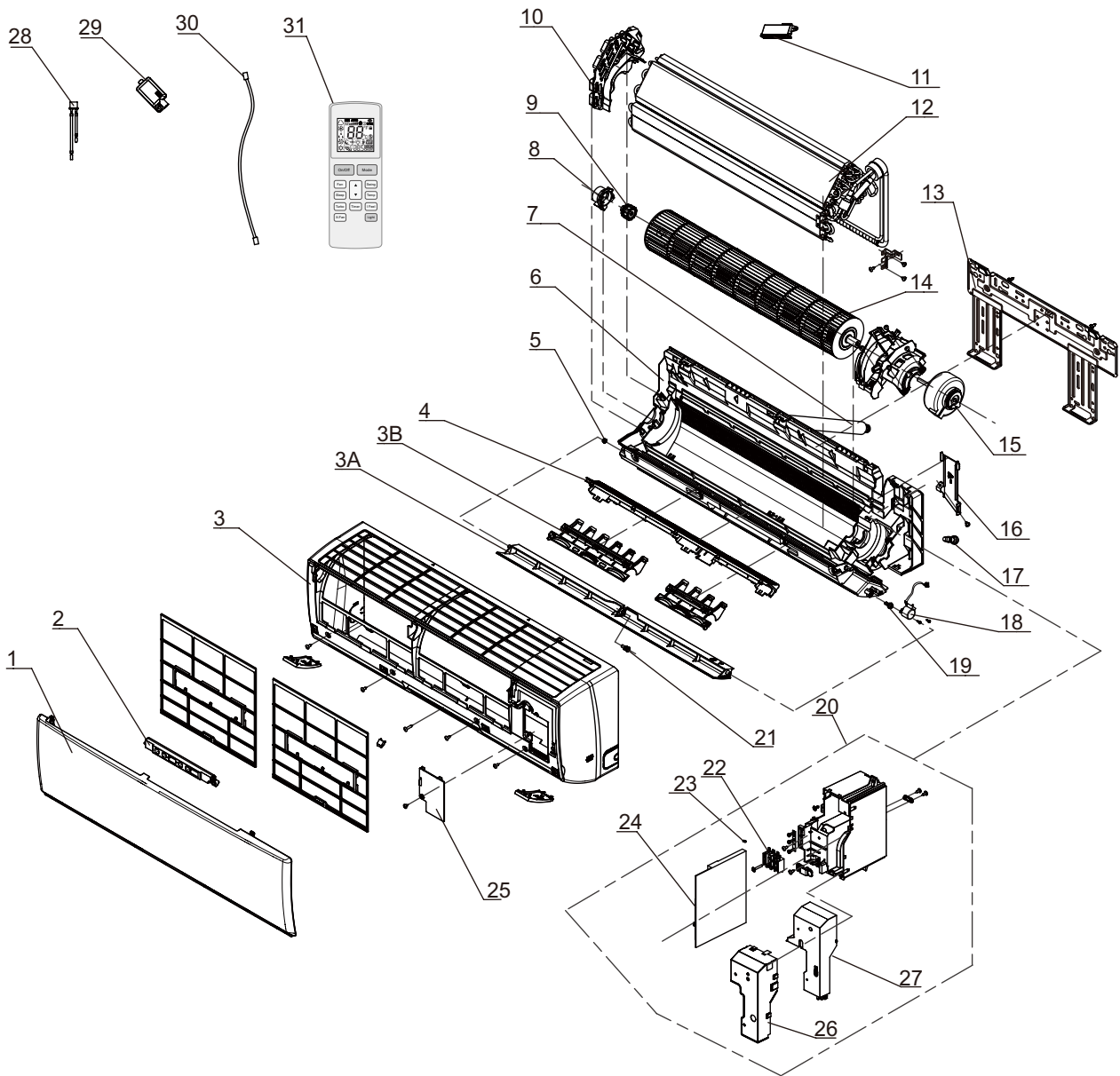

The component picture is only for reference; please refer to the actual product.

NO.	Description
1	Front Panel Assy
2	Display Board
3	Front Case Assy
3A	Guide Louver
3B	Air Louver
4	Helicoid Tongue
5	Left Axile Bush
6	Rear Case assy
7	Drainage Hose
8	Ring of Bearing
9	O-Gasket sub-assy of Bearing
10	Evaporator Support
11	Cold Plasma Generator
12	Evaporator Assy
13	Wall Mounting Frame
14	Cross Flow Fan
15	Fan Motor
16	Connecting pipe clamp
17	Rubber Plug (Water Tray)
18	Stepping Motor
19	Crank
20	Electric Box Assy
21	Axile Bush
22	Terminal Board
23	Jumper
24	Main Board
25	Electric Box Cover Sub-Assy
26	Shield Cover of Electric Box Cover
27	Electric Box Cover
28	Temperature Sensor
29	Detecting Plate
30	Connecting Cable
31	Remote Controller

Some models may not contain some parts, please refer to the actual product.

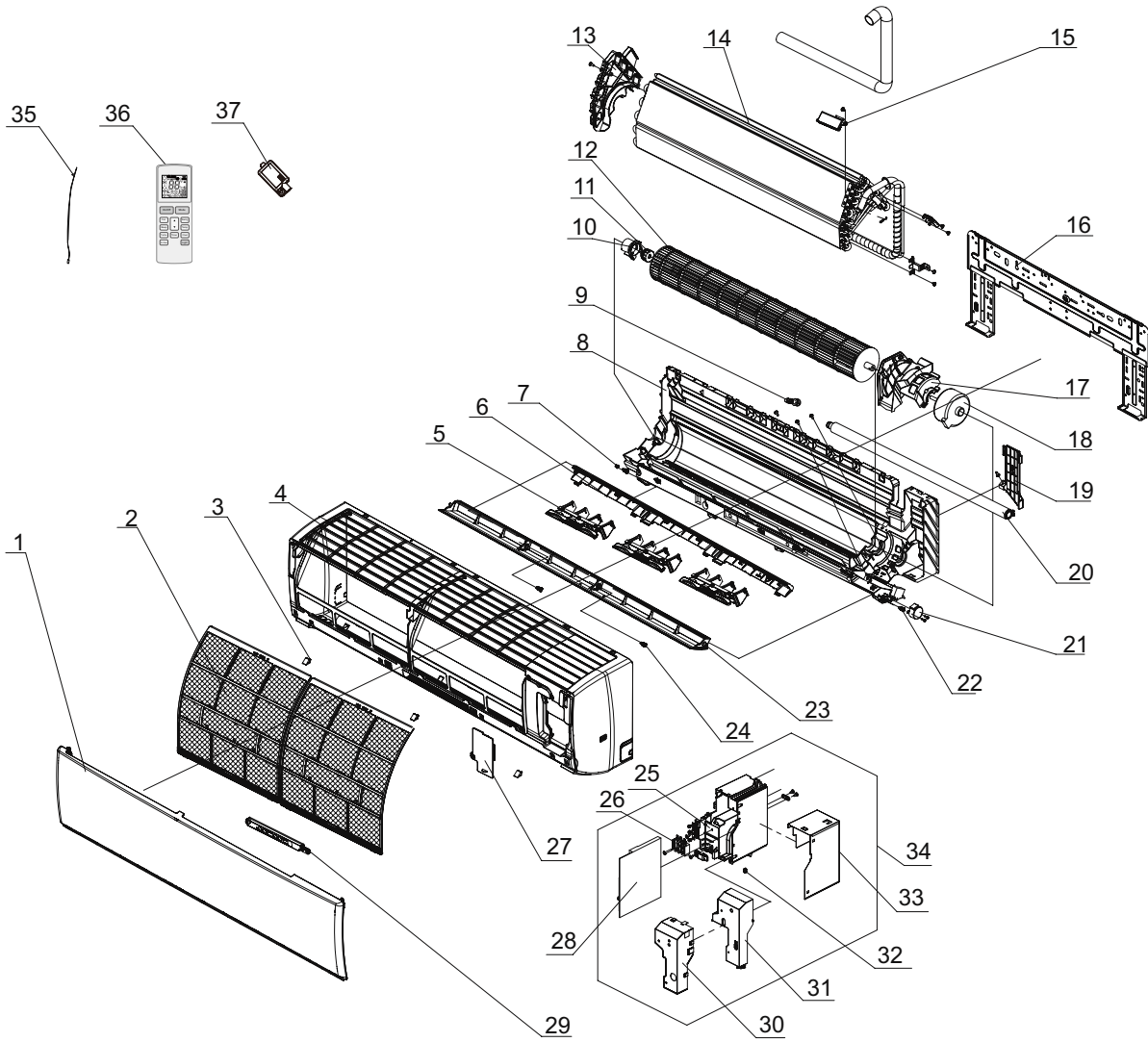

NO.	Description
1	Front Panel Assy
2	Filter Sub-Assy
3	Screw Cover
4	Front Case Assy
5	Air Louver(Manual)
6	Helicoid Tongue
7	Left Axile Bush
8	Rear Case assy
9	Rubber Plug (Water Tray)
10	Ring of Bearing
11	O-Gasket sub-assy of Bearing
12	Cross Flow Fan
13	Evaporator Support
14	Evaporator Assy
15	Cold Plasma Generator
16	Wall Mounting Frame
17	Motor Press Plate
18	Fan Motor
19	Connecting pipe clamp
20	Drainage Hose
21	Stepping Motor
22	Crank
23	Guide Louver
24	Axile Bush
25	Electric Box
26	Terminal Board
27	Electric Box Cover2
28	Main Board
29	Display Board
30	Shield cover of Electric Box
31	Electric Box Cover
32	Jumper
33	Lower Shield of Electric Box
34	Electric Box Assy
35	Temperature Sensor
36	Remote Controller
37	Test Board Assy

Some models may not contain some parts, please refer to the actual product.

10.2 Outdoor Unit

GWH07AGA-K6DNA1C/O GWH09AGA-K6DNA1C/O

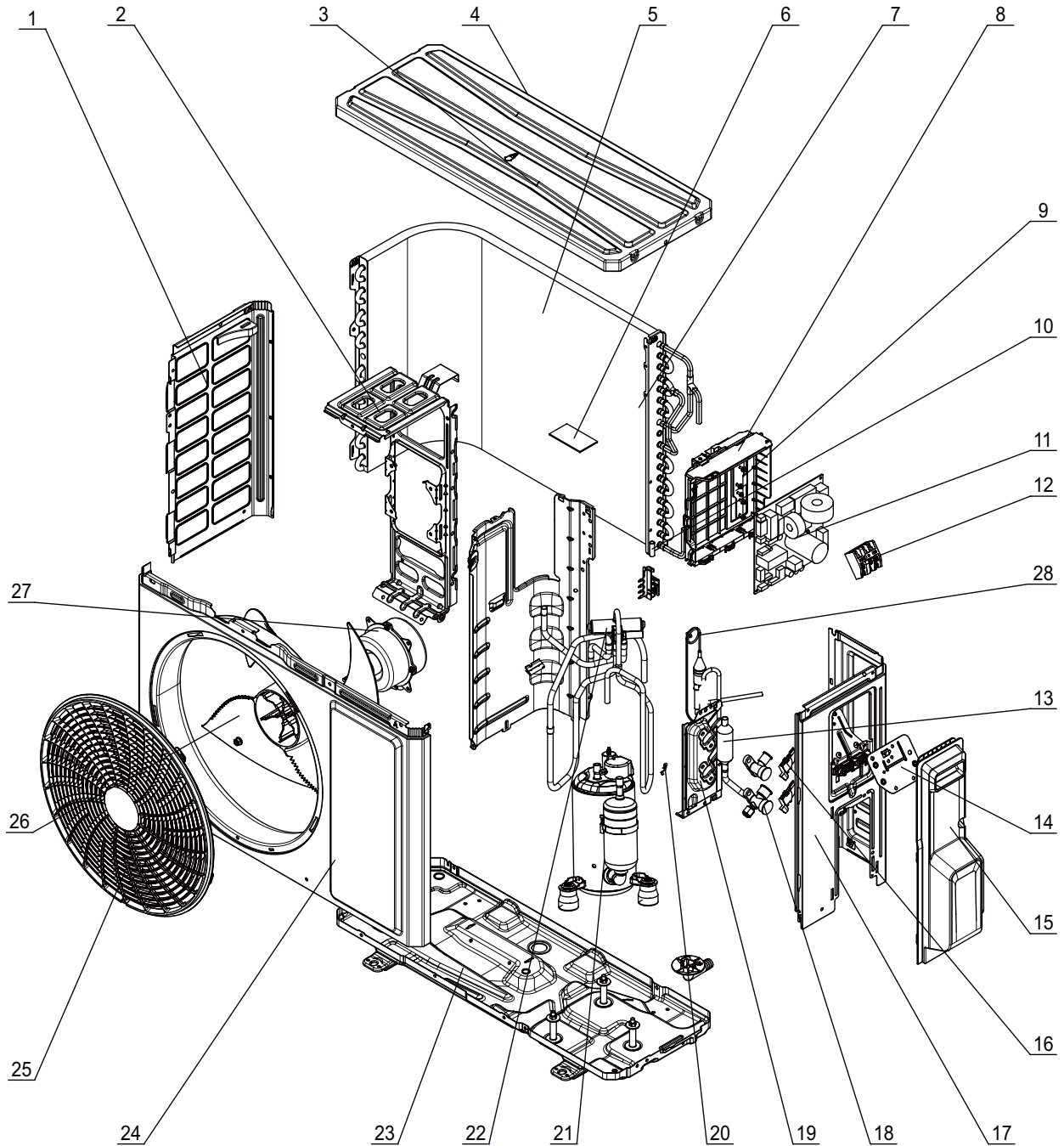

The component is only for reference; please refer to the actual product

NO.	Description
1	Left Side Plate
2	Motor Support
3	Top Cover Sub-Assy
4	Top cover
5	Condenser Sub-Assy
6	Sponge(Condenser)
7	Condenser Assy
8	Electric Box Assy
9	Electric Box
10	Temp Sensor Sleevng
11	Main Board
12	Terminal Board
13	Silencer
14	Earthing Plate Sub-assy
15	Handle
16	Valve Support Block
17	Right Side Plate
18	Cut-off valve 1/4(N)
19	Valve Support
20	Sensor Insert
21	Compressor and Fittings
22	4-Way Valve Assy
23	Chassis Sub-assy
24	Cabinet
25	Front Grill
26	Axial Flow Fan
27	Fan Motor
28	Capillary Sub-assy

Some models may not contain some parts, please refer to the actual product.

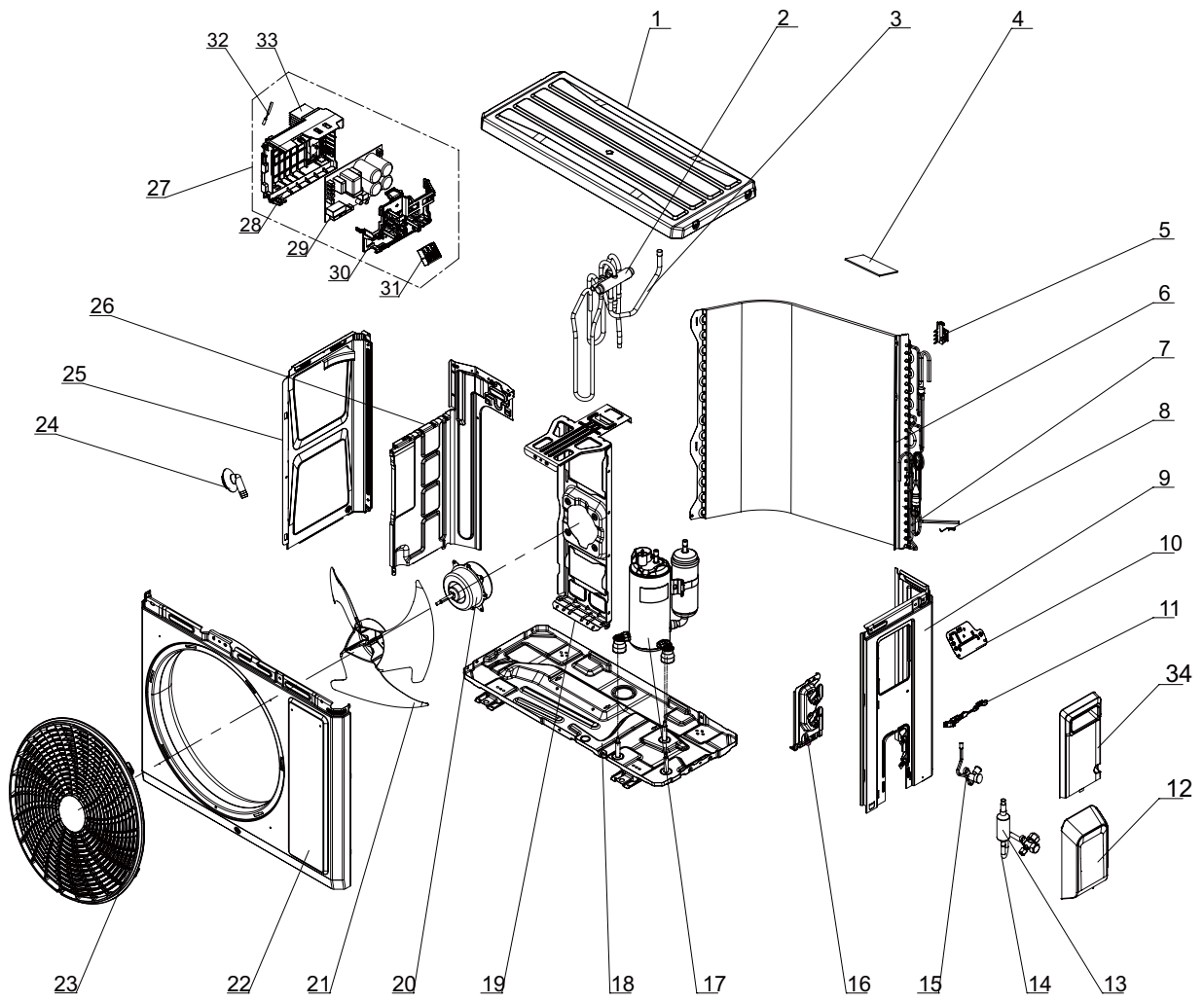

The component is only for reference; please refer to the actual product

NO.	Description	Qty
1	Coping	1
2	4-Way Valve	1
3	4-Way Valve Assy	1
4	Sponge(Condenser)	1
5	Temperature Sensor Support	1
6	Condenser Assy	1
7	Capillary Sub-assy	1
8	Sensor Insert	1
9	Right Side Plate	1
10	Earthing Plate Sub-Assy	1
11	Wire Clamp	1
12	Valve Cover	1
13	Silencer	1
14	Cut-off valve 3/8(N)	1
15	Cut-off valve 1/4(N)	1
16	Valve Support	1
17	Compressor and Fittings	1
18	Chassis Sub-assy	1
19	Motor Support	1
20	Fan Motor	1
21	Axial Flow Fan	1
22	Cabinet	1
23	Front Grill	1
24	Drainage Joint(ODU)	/
25	Left Side Plate	1
26	Clapboard	1
27	Electric Box Assy	1
28	Electric Box	1
29	Main Board	1
30	Electric Box Cover	1
31	Terminal Board	1
32	Temperature Sensor	1
33	Raidator	1
34	Handle (Right)	1

Some models may not contain some parts, please refer to the actual product.

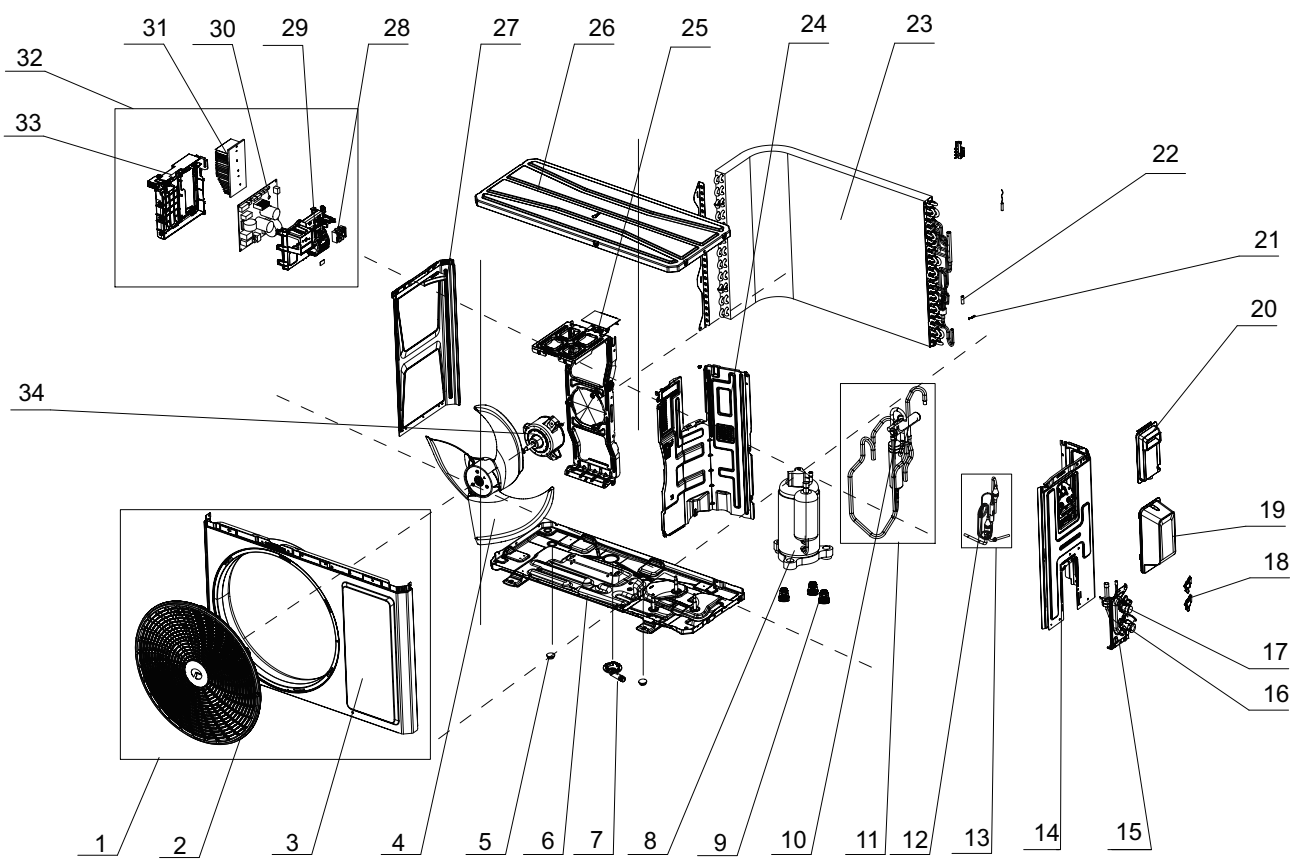

The component is only for reference; please refer to the actual product.

NO.	Description
1	Front Panel Assy
2	Front grill
3	Front Panel
4	Axial Flow Fan
5	Drainage hole Cap
6	Chassis Sub-assy
7	Drainage Joint
8	Compressor and Fittings
9	Compressor Gasket
10	4-Way Valve
11	4-Way Valve Assy
12	Capillary Tube
13	Capillary Tube assy
14	Right Side Plate Assy
15	Valve Support
16	Cut-off valve 1/2(N)
17	Cut-off valve 1/4(N)
18	Valve Support Block
19	Valve Cover
20	handle
21	Sensor Insert
22	Temp Sensor Sleeving
23	Condenser Assy
24	Clapboard Sub-Assy
25	Motor Support Sub
26	Top Cover Sub-Assy
27	Left Side Plate
28	Terminal Board
29	Electric Box Cover
30	Main Board
31	Radiator
32	Electric Box Assy
33	Electric Box
34	Brushless DC Motor

Some models may not contain some parts, please refer to the actual product.

11. Removal Procedure

11.1 Removal Procedure of Indoor Unit

Caution: discharge the refrigerant completely before removal.

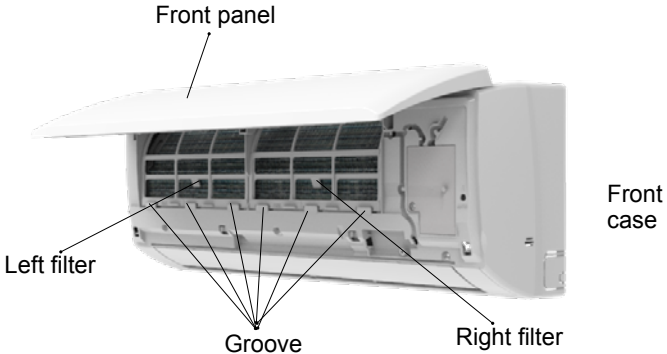
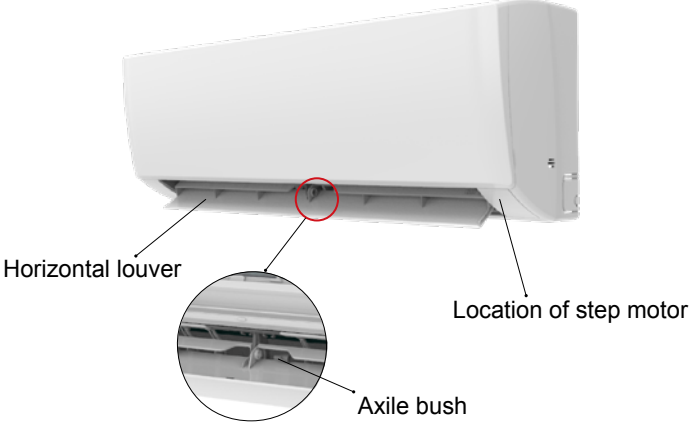
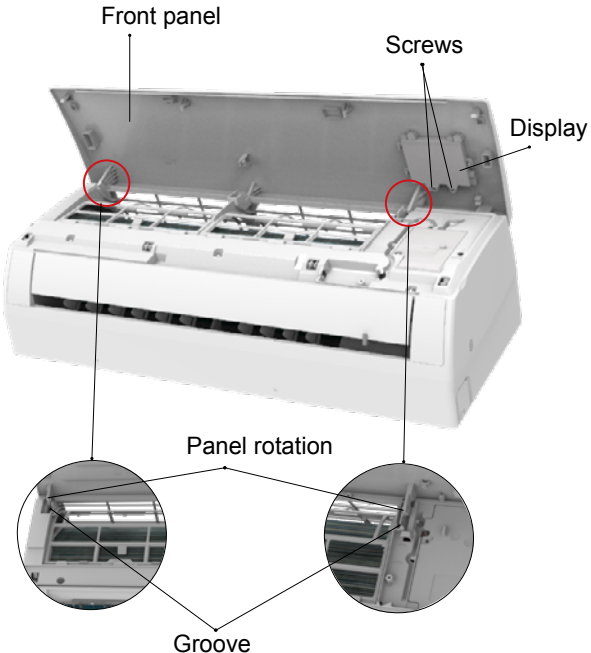
Step	Procedure
<p>1. Remove filter assembly</p> <p>Open the front panel. Push the left filter and right filter until they are separate from the groove on the front panel. Remove the left filter and right filter respectively.</p>	
<p>2. Remove horizontal louver</p> <p>Push out the axle bush on horizontal louver. Bend the horizontal louver with hand and then separate the horizontal louver from the crankshaft of step motor to remove it.</p>	
<p>3. Remove panel</p> <p>a</p> <p>① A1/B6/C2/C4 display: Screw off the 2 screws that are locking the display board. Separate the display board from the front panel. ② A2/A3 display: Screw off the 2 screws that are locking the display board. This display can be disassembled only after removing the front case (refer to step 5 of disassembly). ③ A5/B2/B4/B8/C6/D2 display: Screw off the 2 screws that are locking the display board.</p> <p>b</p> <p>Separate the panel rotation shaft from the groove fixing the front panel and then removes the front panel.</p>	

Step	Procedure	Image
<p>4. Remove detecting plate(wifi) and electric box cover2</p>	<p>Remove the screws fixing detecting plate and remove detecting plate(wifi).</p> <p>Remove the screws fixing electric box cover 2 and remove electric box cover 2.</p>	
<p>5. Remove front case sub-assy</p>	<p>Remove the screws fixing front case.</p> <p>Note:</p> <p>a 1.Open the screw caps before removing the screws around the air outlet.</p> <p>2.The quantity of screws fixing the front case sub-assy is different for different models.</p> <p>b Loosen the connection clasps between front case sub-assy and bottom case. Lift up the front case sub-assy and take it out.</p>	
<p>6. Remove vertical louver</p>	<p>Loosen the connection clasps between vertical louver and bottom case to remove vertical louver.</p>	

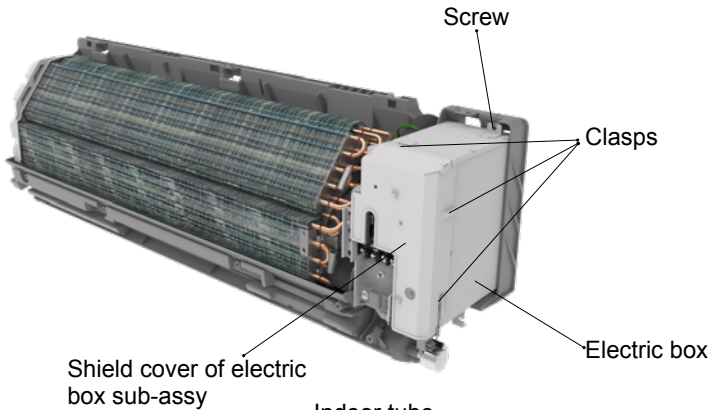
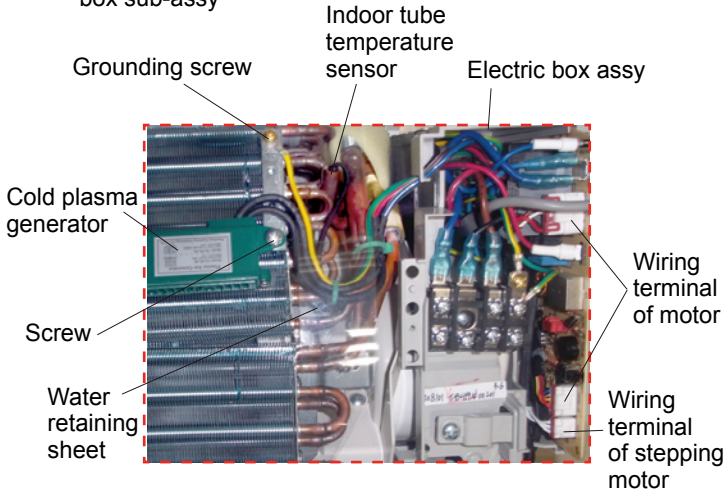
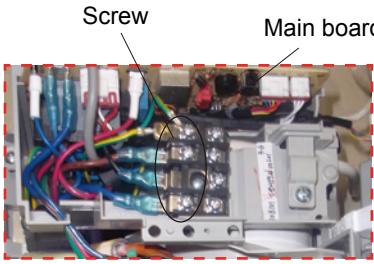
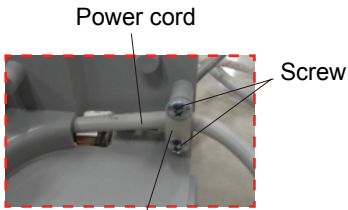
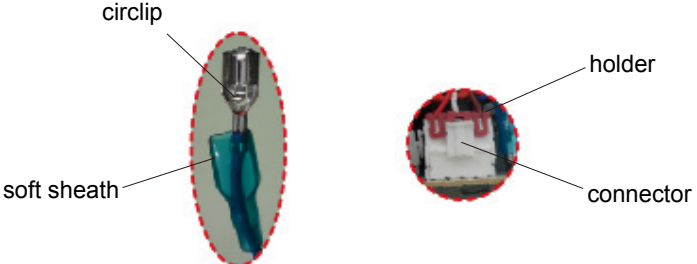
Step	Procedure
7. Remove electric box assy	
<p>a</p>	<p>Loosen the connection clasps between shield cover of electric box sub-assy and electric box, and then remove the shield cover of electric box sub-assy. Remove the screw fixing electric box assy .</p> 
<p>b</p>	<p>① Take off the water retaining sheet. Remove the cold plasma generator by screwing off the locking screw on the generator. ② Take off the indoor tube temperature sensor. ③ Screw off 1 grounding screw. ④ Remove the wiring terminals of motor and stepping motor. ⑤ Remove the electric box assy.</p> 
<p>c</p>	<p>Twist off the screws that are locking each lead wire and rotate the electric box assy. Twist off the screws that are locking the wire clip. Loosen the power cord and remove its wiring terminal. Lift up the main board and take it off.</p>  
<p>d</p>	<p>Instruction: Some wiring terminal of this product is with lock catch and other devices. The pulling method is as below: 1.Remove the soft sheath for some terminals at first, hold the circlip and then pull out the terminals. 2.Pull out the holder for some terminals at first (holder is not available for some wiring terminal), hold the connector and then pull the terminal.</p> 

Step	Procedure
7.Remove evaporator assy	
a	Remove 3 screws fixing evaporator assy.
b	At the back of the unit, remove the screw fixing connection pipe clamp and then remove the connection pipe clamp.
c	First remove the left side of the evaporator from the groove of bottom case and then remove the right side from the clasp on the bottom case.
d	Adjust the position of connection pipe on evaporator slightly and then lift the evaporator upwards to remove it.

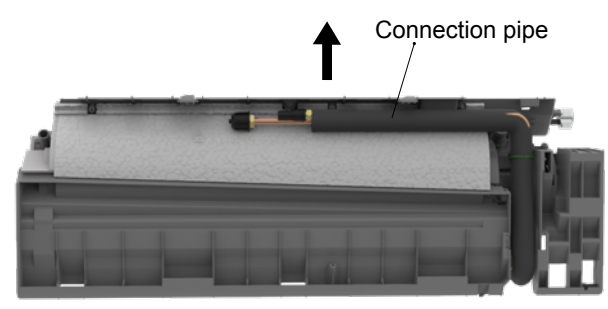
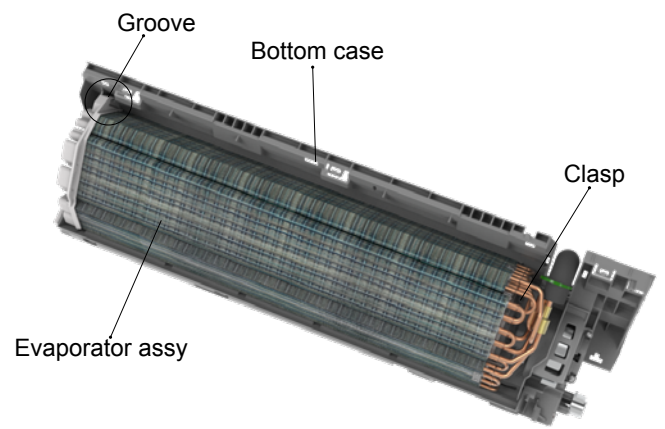
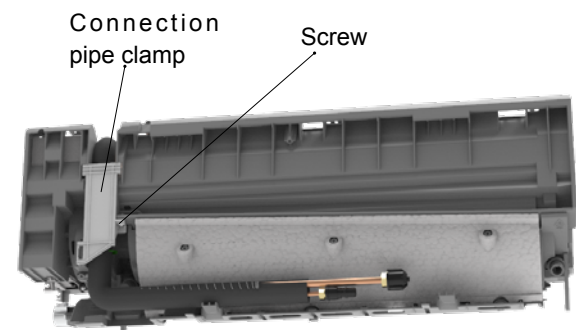
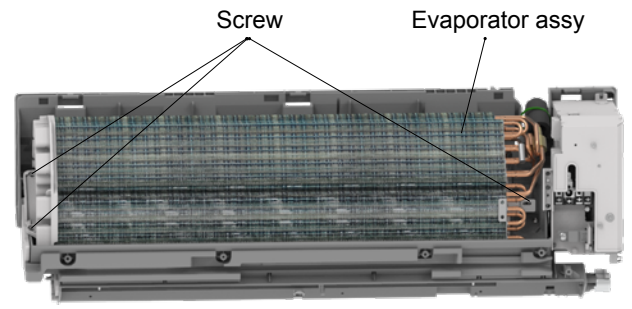

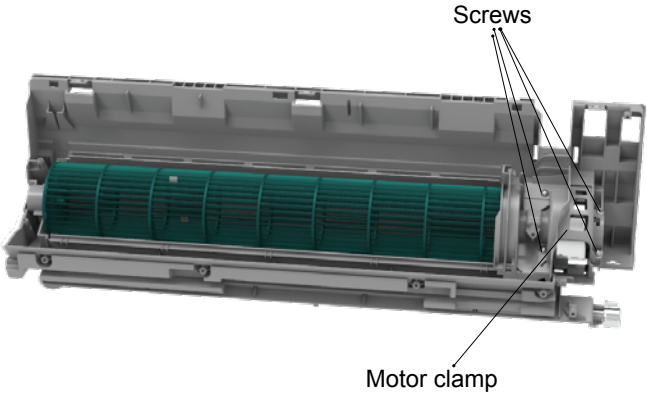
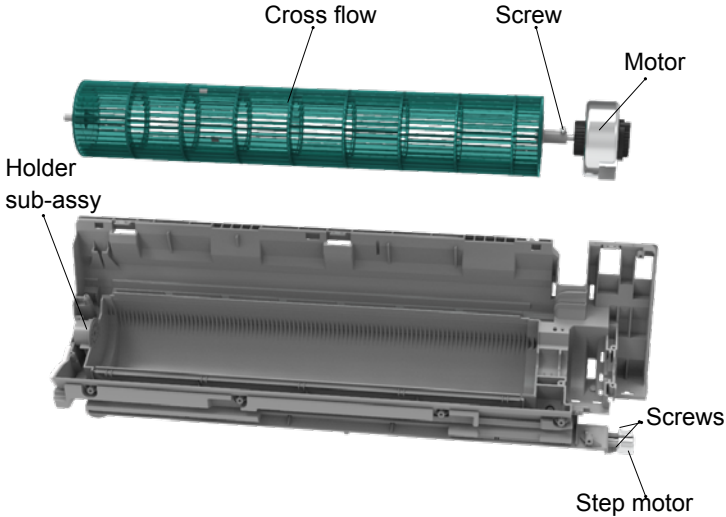

Step	Procedure
9. Remove motor and cross flow blade	
a	<p>Remove the screws fixing motor clamp and then remove the motor clamp.</p> 
b	<p>Remove the screws at the connection place of cross flow blade and motor; lift the motor and cross flow blade upwards to remove them. Remove the bearing holder sub-assy. Remove the screw fixing step motor and then remove the step motor.</p> 

11.2 Removal Procedure of Outdoor Unit



Caution: discharge the refrigerant completely before removal.

GWH07AGA-K6DNA1C/O GWH09AGA-K6DNA1C/O

Step	Procedure
1. Before disassembly	
2. Remove top cover	<p data-bbox="191 1131 787 1190">Remove the screws fixing top panel and then remove the top panel.</p> 
3. Remove big handle	<p data-bbox="191 1749 787 1808">Remove the screws fixing big handle, then remove the big handle.</p> 

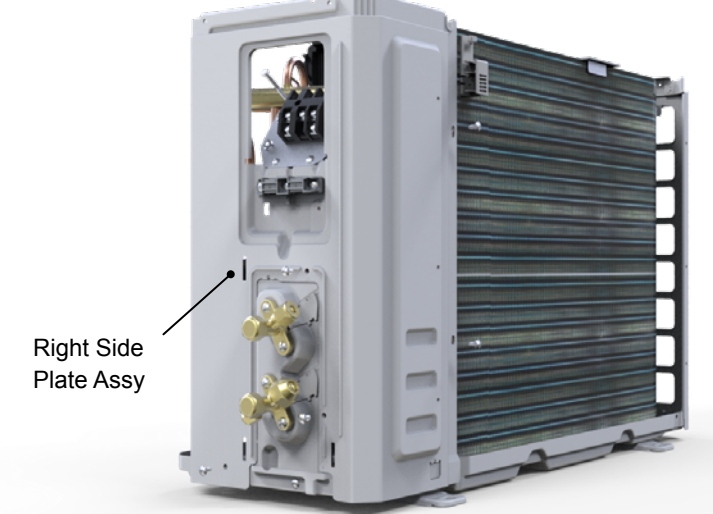
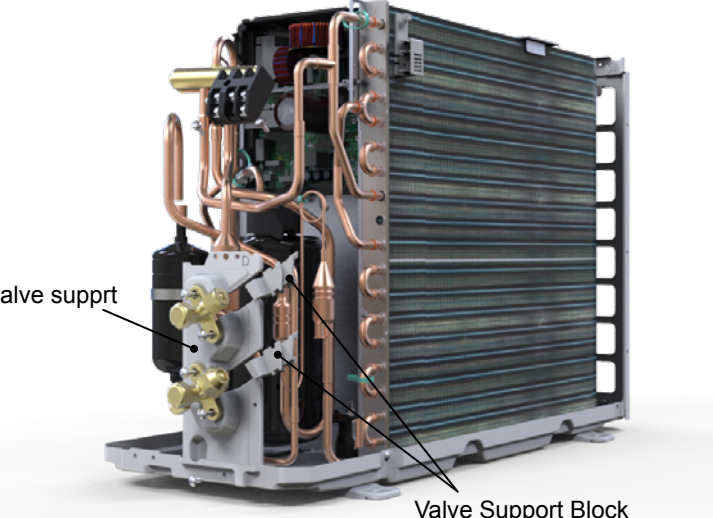
Step	Procedure
<p>4. Remove front panel assy</p>	<p>Remove connection screws connecting the front panel assy with the chassis and the motor support, and then remove the front panel assy.</p> 
<p>5. Remove right side plate assy</p>	<p>Rescrew the ground screws, remove the ground wires, loosen the screws fixing terminal board, remove the terminal board, rescrew the screws fixing the right plate, and remove the right side plate assy.</p> 
<p>6. Remove valve support</p>	<p>Remove the valve support block, remove the screws fixing valve support, remove the screws fixing the liquid valve and gas valve then remove the valve support.</p> 

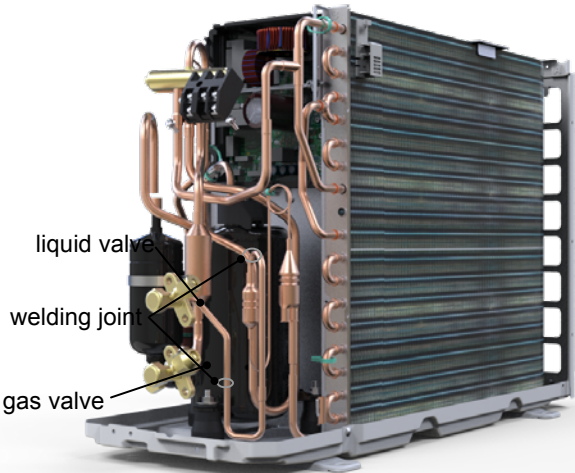
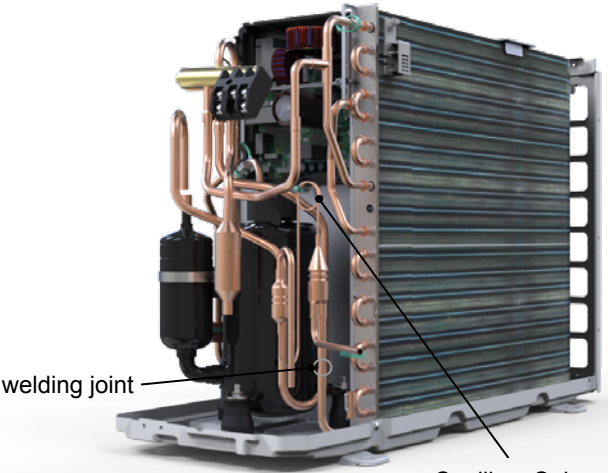
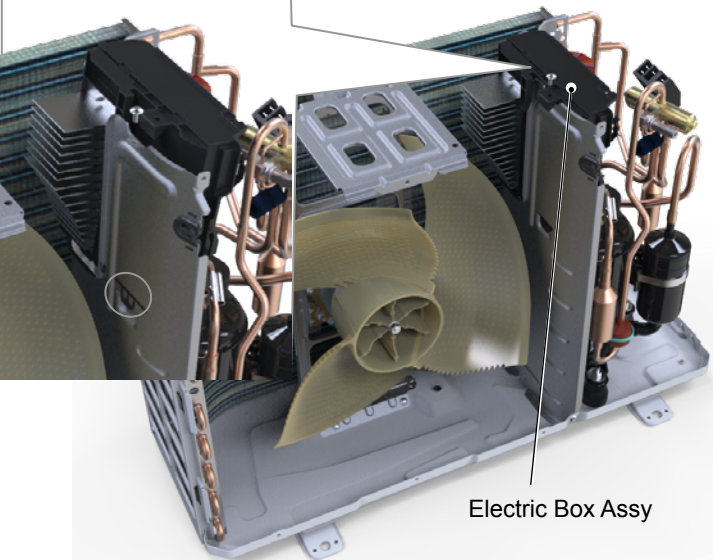

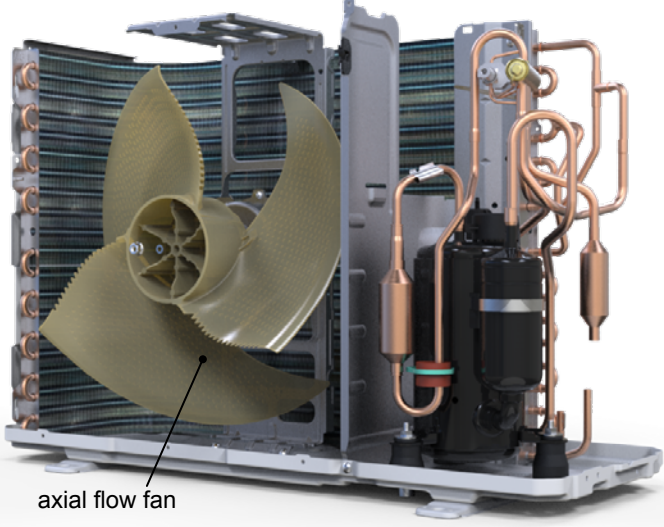
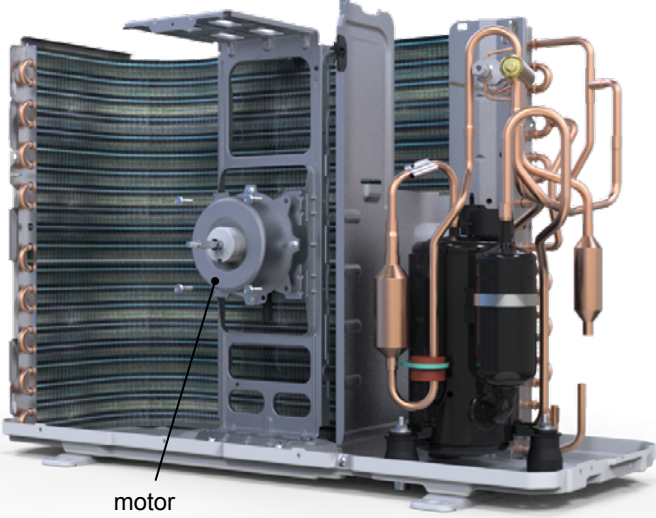
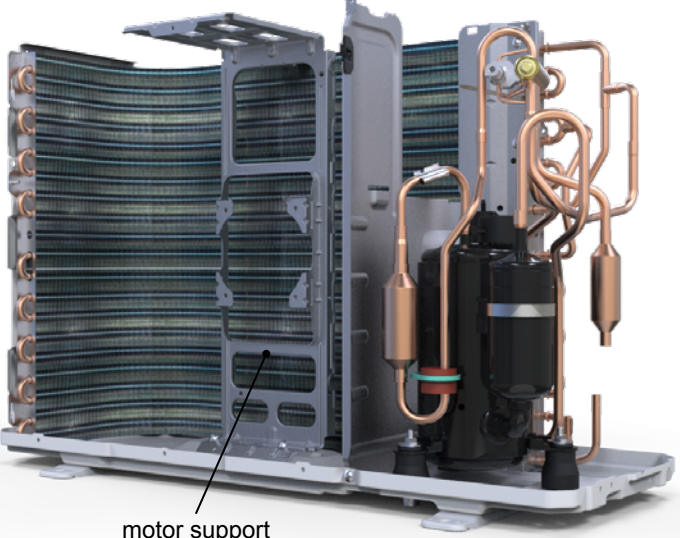
Step	Procedure
<p>7. Remove gas valve and liquid valve</p> <p>Unsolder the welding joint connecting the gas valve and the liquid valve, remove them.</p> <p>Note: Discharge the refrigerant completely before unsoldering; when unsoldering, wrap the gas valve with a wet cloth completely to avoid damage to the valve caused by high temperature.</p>	 <p>liquid valve</p> <p>welding joint</p> <p>gas valve</p>
<p>8. Remove Capillary Sub-assy</p> <p>Unsolder the welding joint connecting the capillary sub-assy and then remove the capillary sub-assy.</p>	 <p>welding joint</p> <p>Capillary Sub-assy</p>
<p>9. Remove electric box assy</p> <p>Unplug the terminals, unscrew 1 screw that secures the electrical box assy, raise it to the top right and remove the electrical box.</p>	 <p>Electric Box Assy</p>

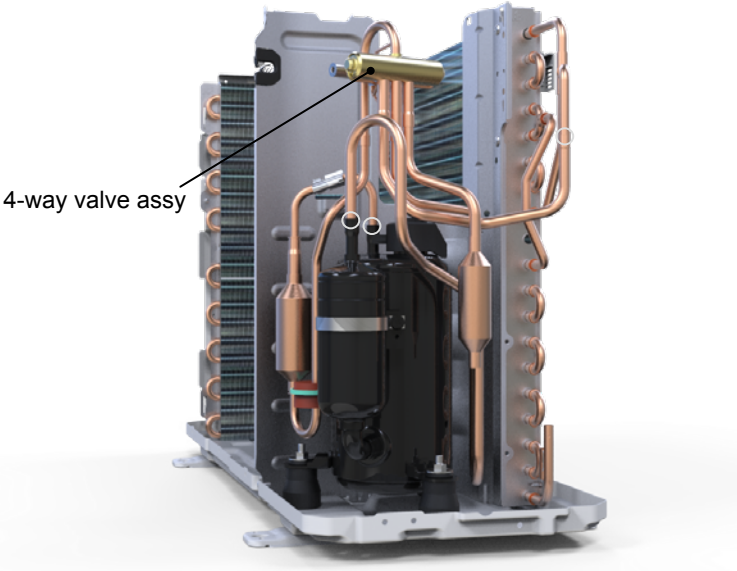
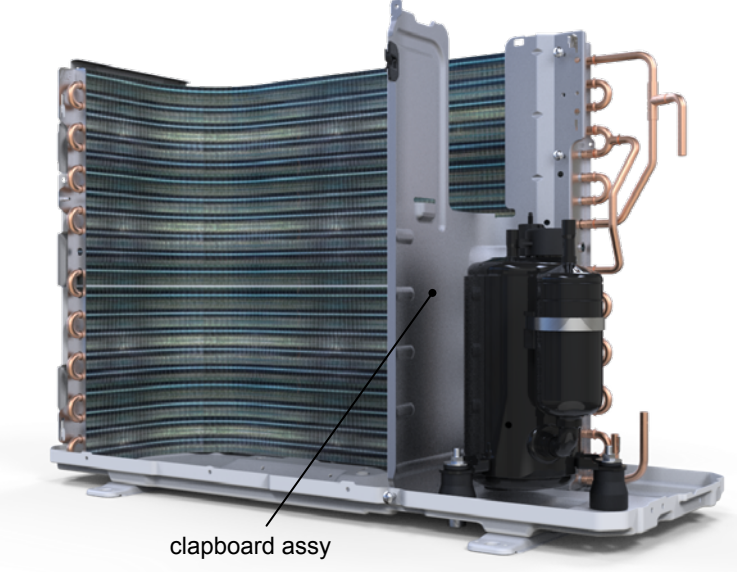
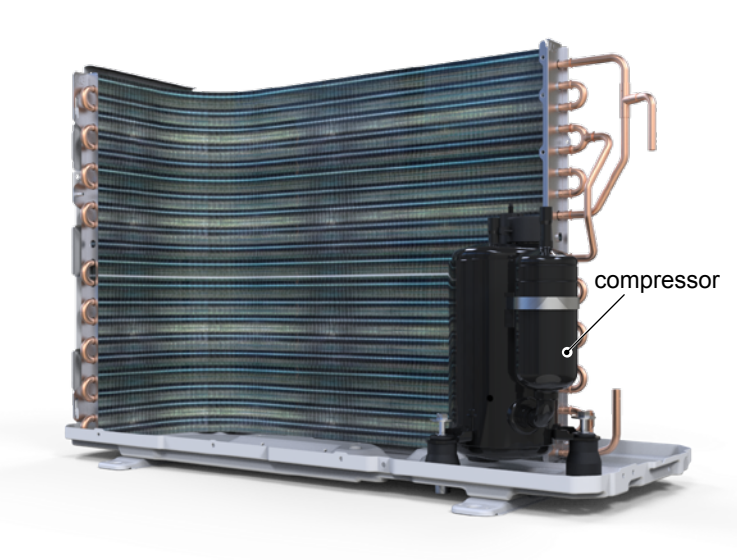

Step	Procedure
<p>10. Remove axial flow fan</p> <p>Remove the nut on the fan and then remove the axial flow fan.</p>	 <p>axial flow fan</p>
<p>11. Remove motor</p> <p>Remove the screws fixing the motor and then remove the motor.</p>	 <p>motor</p>
<p>12. Remove motor support</p> <p>Remove the screws fixing the motor support and lift the motor support to remove it.</p>	 <p>motor support</p>

Step	Procedure
<p>13. Remove 4-way valve assy</p>	<p>Unsolder the welding joints connecting the 4-way valve assy, remove the 4-way valve.</p> <p>Note: Before unsoldering the welding joint, wrap the 4-way valve with a wet cloth completely to avoid damage to the valve caused by high temperature.</p> 
<p>14. Remove clapboard assy</p>	<p>Remove the 3 screws fixing the clapboard assy and then remove the clapboard assy.</p> 
<p>15. Remove compressor</p>	<p>Remove the 3 foot nuts on the compressor and then remove the compressor.</p> 

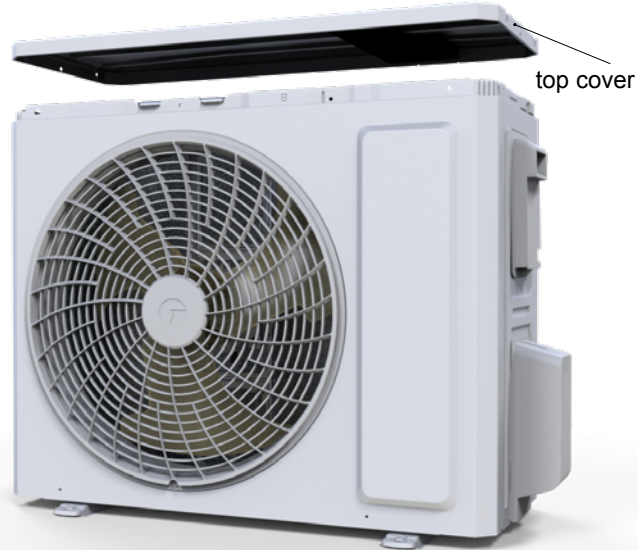

Caution: discharge the refrigerant completely before removal.

Step	Procedure
<p>1. Before disassembly</p>	
<p>2. Remove top cover</p>	<p>Remove the screws fixing top panel and then remove the top panel.</p> 
<p>3. Remove big handle and valve cover</p>	<p>Remove the screws fixing big handle, valve cover and then remove them.</p> 

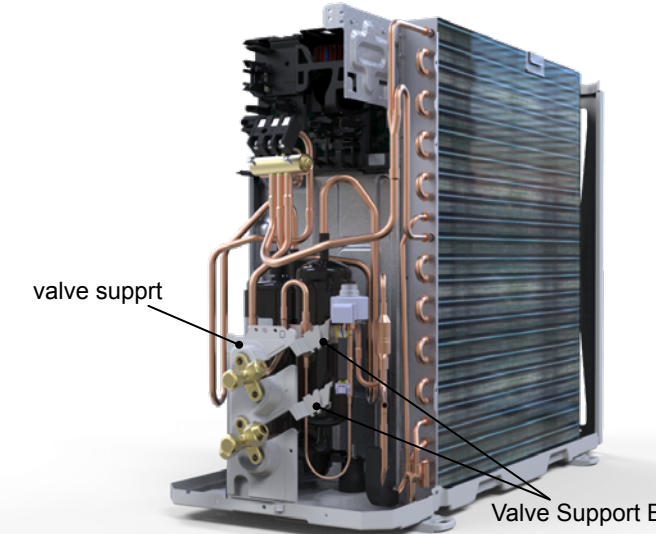

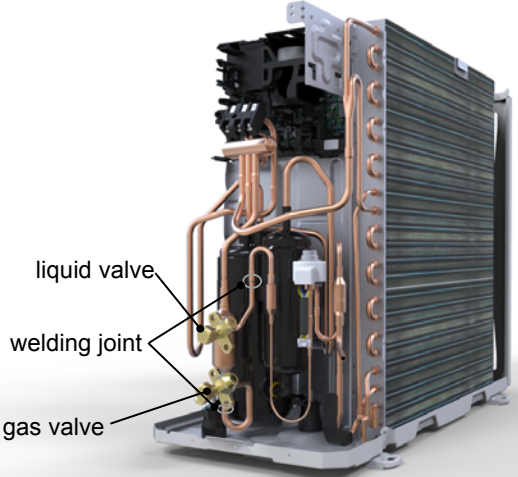
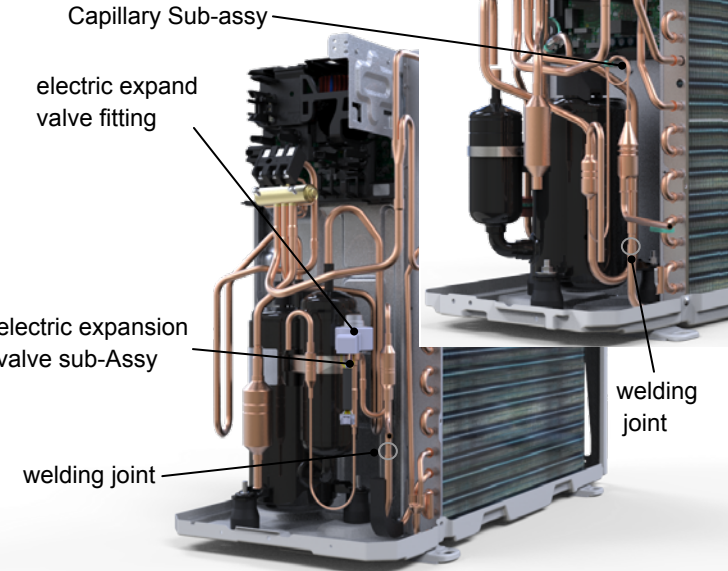
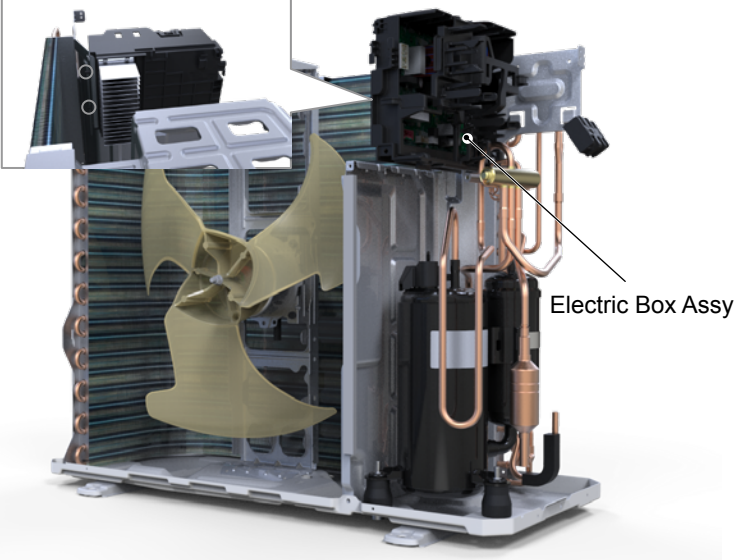
Step	Procedure
<p>4. Remove front panel assy</p>	<p>Remove connection screws connecting the front panel assy with the chassis and the motor support, and then remove the front panel assy.</p>  <p>Front Panel Assy</p>
<p>5. Remove right side plate assy</p>	<p>Rescrew the ground screws, remove the ground wires, loosen the screws fixing terminal board, remove the terminal board, rescrew the screws fixing the right plate, and remove the right side plate assy.</p>  <p>Right Side Plate Assy</p>
<p>6. Remove valve support</p>	<p>Remove the valve support block, remove the screws fixing valve support, remove the screws fixing the liquid valve and gas valve then remove the valve support.</p>  <p>valve support</p> <p>Valve Support Block</p>

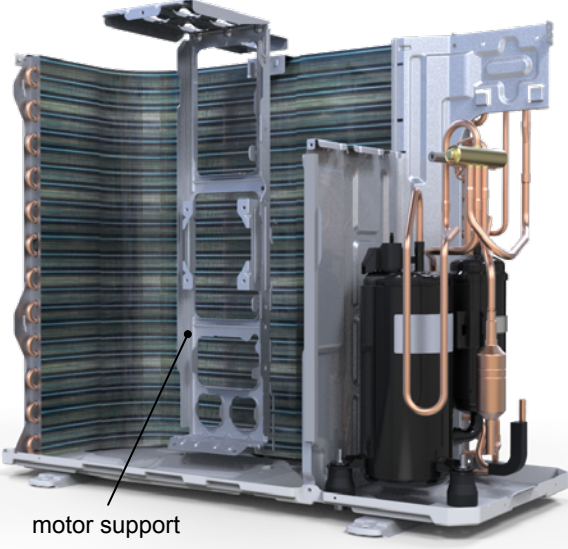
Step	Procedure
<p>7. Remove gas valve and liquid valve</p>	<p>Unsolder the welding joint connecting the gas valve and the liquid valve, remove them.</p> <p>Note: Discharge the refrigerant completely before unsoldering; when unsoldering, wrap the gas valve with a wet cloth completely to avoid damage to the valve caused by high temperature.</p>  <p>liquid valve welding joint gas valve</p>
<p>8. Remove electronic expansion valve or capillary sub-assy</p>	<p>For electronic expansion valve models Remove the terminals of the electronic expansion valve coil and rotate to remove the electronic expansion valve coil.</p> <p>Unsolder the welding joint connecting the electronic expansion Valve and then remove the electronic expansion valve.</p> <p>For capillary models Unsolder the welding joint connecting the capillary sub-assy and then remove the capillary sub-assy.</p>  <p>Capillary Sub-assy electric expand valve fitting electric expansion valve sub-assy welding joint</p>
<p>9. Remove electric box assy</p>	<p>Unplug the terminals, unscrew 1 screw that secures the electrical box assy, release the two snaps on the electrical box assy (in the clapboard and condenser angle), pull outwards, and remove the electrical box assy.</p>  <p>Electric Box Assy</p>

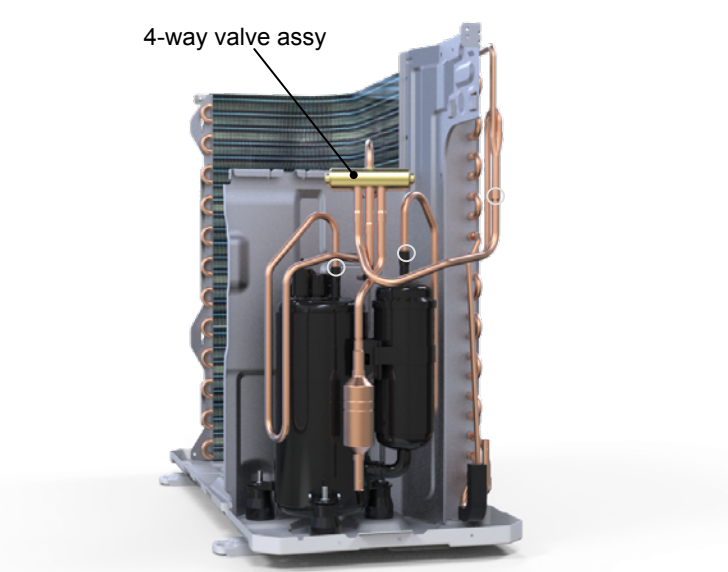
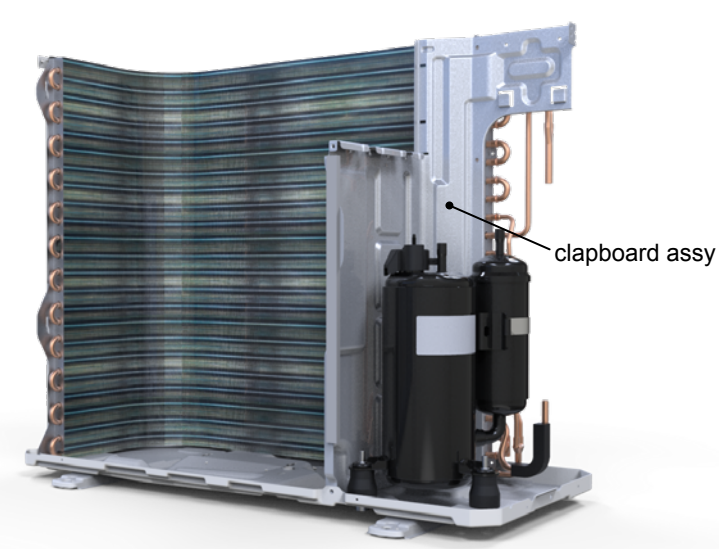
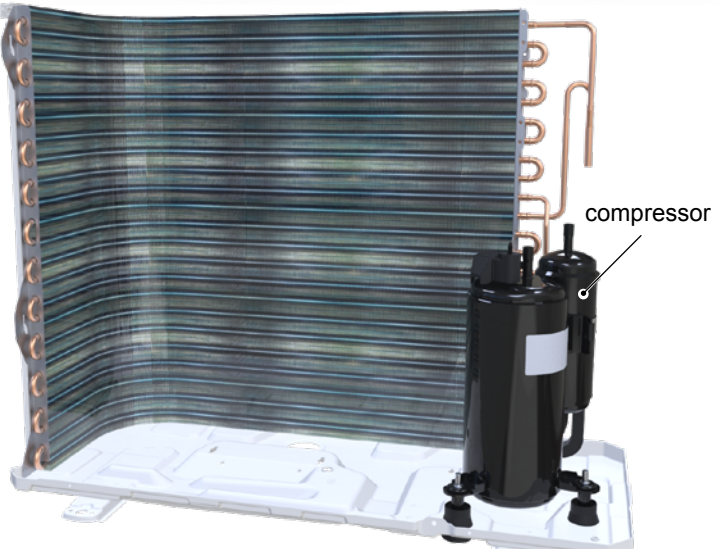
Step	Procedure
<p>10. Remove axial flow fan</p>	<p>Remove the nut on the fan and then remove the axial flow fan.</p> 
<p>11. Remove motor</p>	<p>Remove the screws fixing the motor and then remove the motor.</p> 
<p>12. Remove motor support</p>	<p>Remove the screws fixing the motor support and lift the motor support to remove it.</p> 

Step	Procedure
<p>13. Remove 4-way valve assy</p>	<p>Unsolder the welding joints connecting the 4-way valve assy, remove the 4-way valve.</p> <p>Note: Before unsoldering the welding joint, wrap the 4-way valve with a wet cloth completely to avoid damage to the valve caused by high temperature.</p> 
<p>14. Remove clapboard assy</p>	<p>Remove the screws fixing the clapboard assy and then remove the clapboard assy.</p> 
<p>15. Remove compressor</p>	<p>Remove the 3 foot nuts on the compressor and then remove the compressor.</p> 

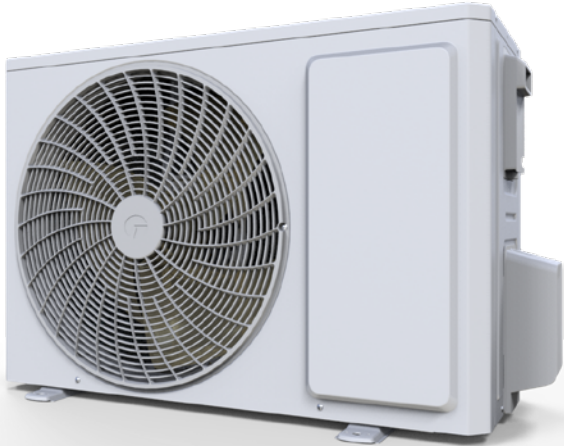
**Caution: discharge the refrigerant completely before removal.**

Step	Procedure
1. Before disassembly	
2. Remove top cover	<p data-bbox="191 1109 787 1170">Remove the screws fixing top panel and then remove the top panel.</p> 
3. Remove big handle and valve cover	<p data-bbox="191 1690 787 1751">Remove the screws fixing big handle, valve cover and then remove them.</p> 

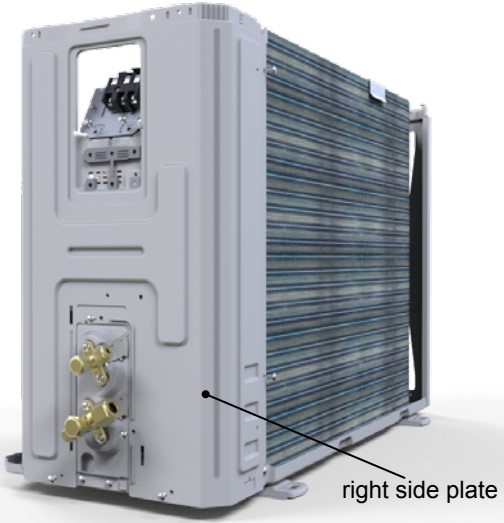
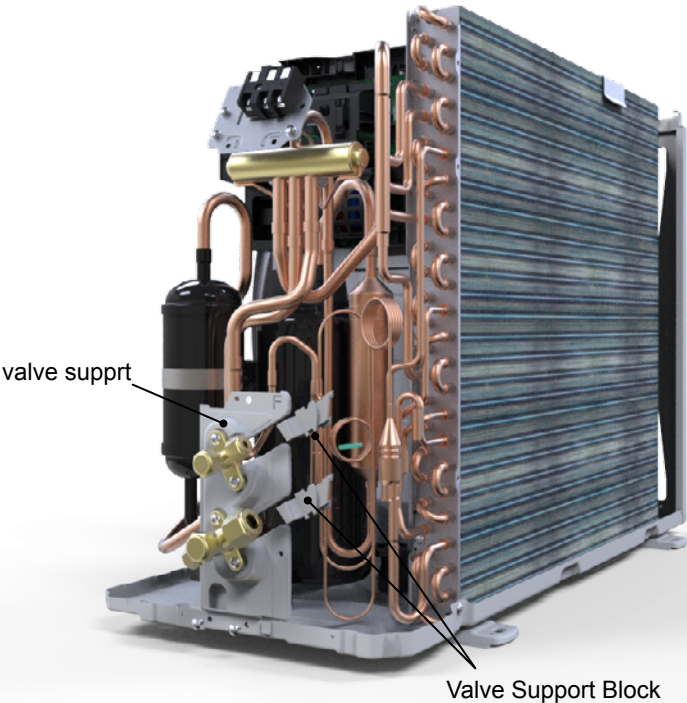
Step	Procedure
<p>4. Remove front panel assy</p>	<p>Remove connection screws connecting the front panel assy with the chassis and the motor support, and then remove the front panel assy.</p> 
<p>5. Remove right side plate assy</p>	<p>Rescrew the ground screws, remove the ground wires, loosen the screws fixing terminal board, remove the terminal board, rescrew the screws fixing the right plate, and remove the right side plate assy.</p> 
<p>6. Remove valve support</p>	<p>Remove the valve support block, remove the screws fixing valve support, remove the screws fixing the liquid valve and gas valve then remove the valve support.</p> 

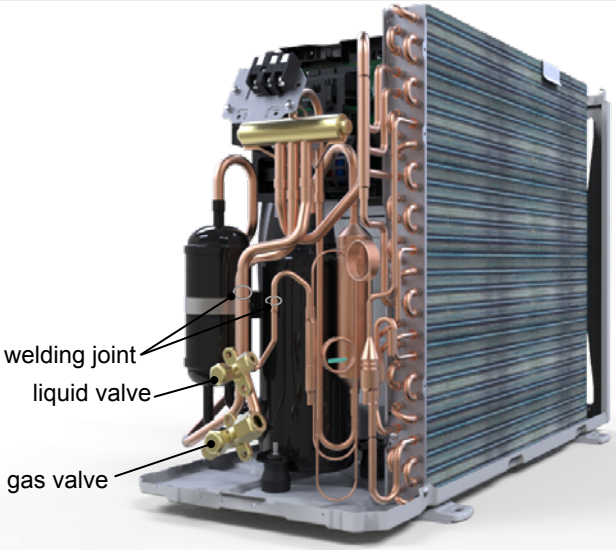
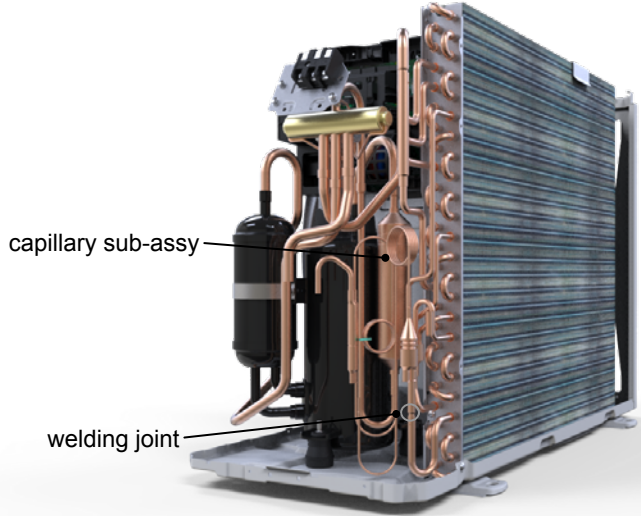
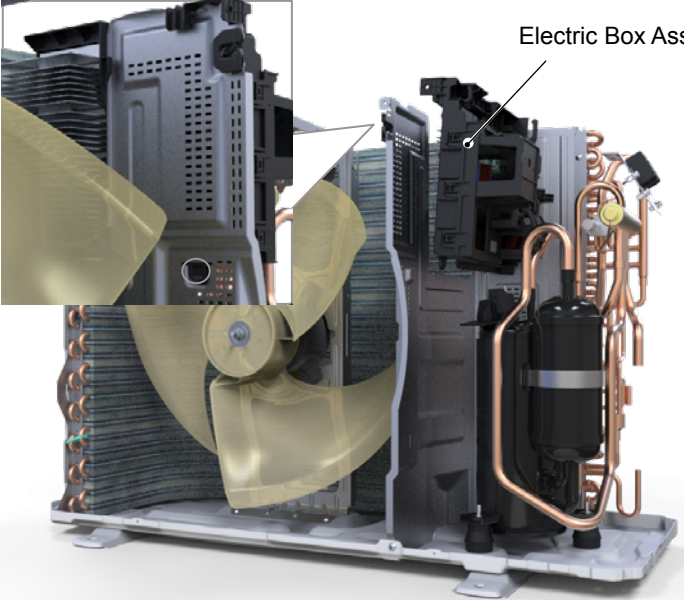
Step	Procedure
<p>7. Remove gas valve and liquid valve</p> <p>Unsolder the welding joint connecting the gas valve and the liquid valve, remove them.</p> <p>Note: Discharge the refrigerant completely before unsoldering; when unsoldering, wrap the gas valve with a wet cloth completely to avoid damage to the valve caused by high temperature.</p>	 <p>welding joint</p> <p>liquid valve</p> <p>gas valve</p>
<p>8. Remove Capillary Sub-assy</p> <p>Unsolder the welding joint connecting the capillary sub-assy and then remove the capillary sub-assy.</p>	 <p>capillary sub-assy</p> <p>welding joint</p>
<p>9. Remove electric box assy</p> <p>Remove the terminals, lift up and rotate the electrical box assy to the right so that the snaps on the clapboard are removed and the electrical box assy are removed.</p>	 <p>Electric Box Assy</p>

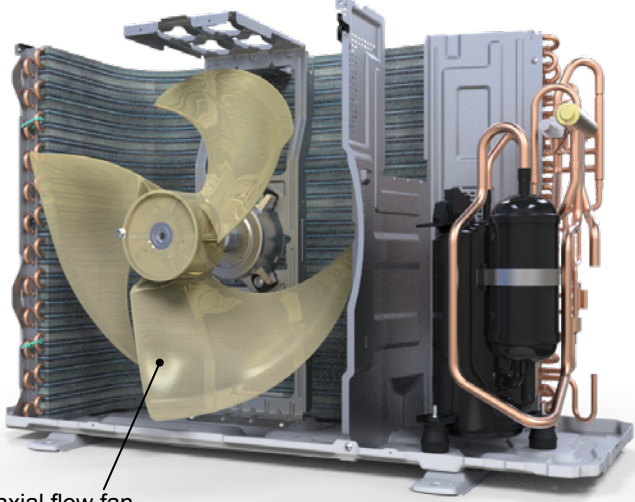
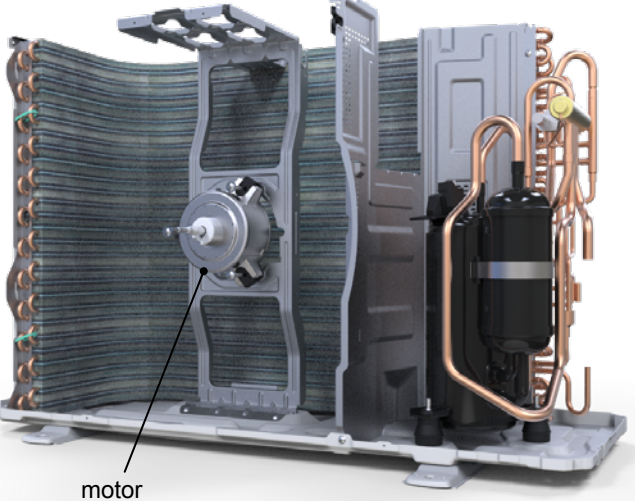
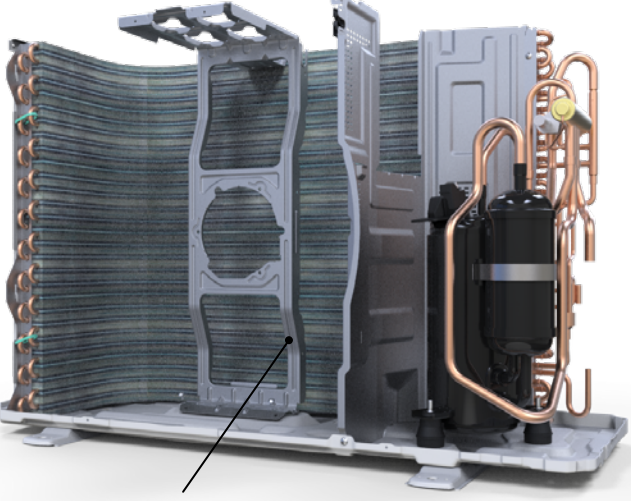
Step	Procedure
<p>10. Remove axial flow fan</p>	<p>Remove the nut on the fan and then remove the axial flow fan.</p> 
<p>11. Remove motor</p>	<p>Remove the screws fixing the motor and then remove the motor.</p> 
<p>12. Remove motor support</p>	<p>Remove the screws fixing the motor support and lift the motor support to remove it.</p> 

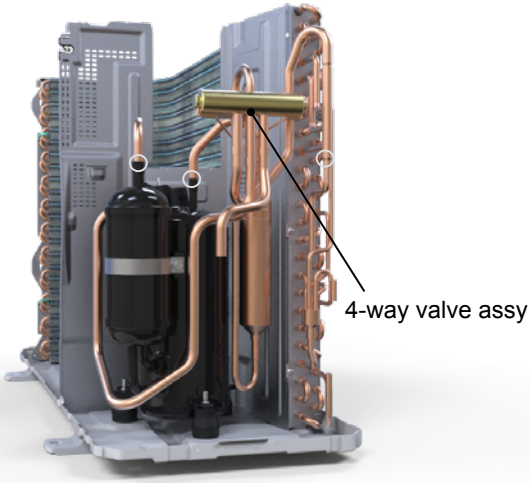
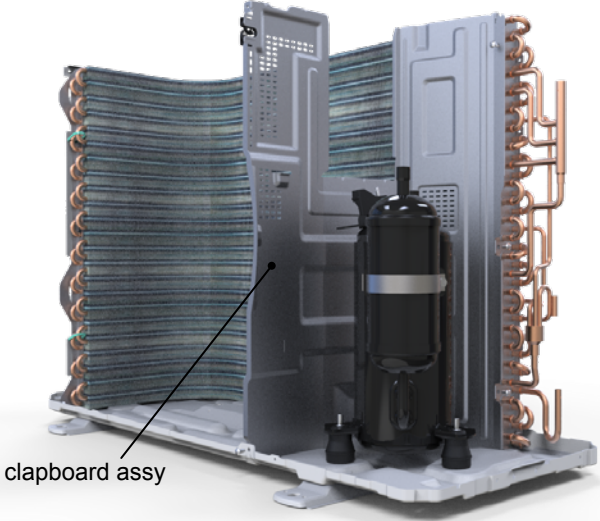
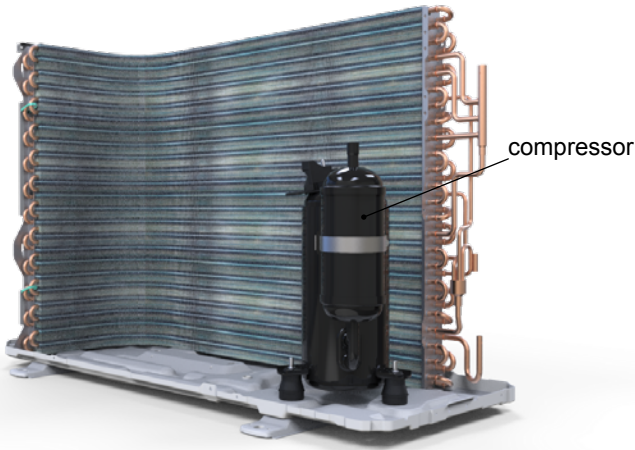
Step	Procedure
<p>13. Remove 4-way valve assy</p>	<p>Unsolder the welding joints connecting the 4-way valve assy, remove the 4-way valve.</p> <p>Note: Before unsoldering the welding joint, wrap the 4-way valve with a wet cloth completely to avoid damage to the valve caused by high temperature.</p> 
<p>14. Remove clapboard assy</p>	<p>Remove the screws fixing the clapboard assy and then remove the clapboard assy.</p> 
<p>15. Remove compressor</p>	<p>Remove the 3 foot nuts on the compressor and then remove the compressor.</p> 

Appendix

Appendix 1: Reference Sheet of Celsius and Fahrenheit

Conversion formula for Fahrenheit degree and Celsius degree: $T_f = T_c \times 1.8 + 32$

Set temperature

Fahrenheit display temperature (°F)	Fahrenheit (°F)	Celsius (°C)	Fahrenheit display temperature (°F)	Fahrenheit (°F)	Celsius (°C)	Fahrenheit display temperature (°F)	Fahrenheit (°F)	Celsius (°C)
61	60.8	16	69/70	69.8	21	78/79	78.8	26
62/63	62.6	17	71/72	71.6	22	80/81	80.6	27
64/65	64.4	18	73/74	73.4	23	82/83	82.4	28
66/67	66.2	19	75/76	75.2	24	84/85	84.2	29
68	68	20	77	77	25	86	86	30

Ambient temperature

Fahrenheit display temperature (°F)	Fahrenheit (°F)	Celsius (°C)	Fahrenheit display temperature (°F)	Fahrenheit (°F)	Celsius (°C)	Fahrenheit display temperature (°F)	Fahrenheit (°F)	Celsius (°C)
32/33	32	0	55/56	55.4	13	79/80	78.8	26
34/35	33.8	1	57/58	57.2	14	81	80.6	27
36	35.6	2	59/60	59	15	82/83	82.4	28
37/38	37.4	3	61/62	60.8	16	84/85	84.2	29
39/40	39.2	4	63	62.6	17	86/87	86	30
41/42	41	5	64/65	64.4	18	88/89	87.8	31
43/44	42.8	6	66/67	66.2	19	90	89.6	32
45	44.6	7	68/69	68	20	91/92	91.4	33
46/47	46.4	8	70/71	69.8	21	93/94	93.2	34
48/49	48.2	9	72	71.6	22	95/96	95	35
50/51	50	10	73/74	73.4	23	97/98	96.8	36
52/53	51.8	11	75/76	75.2	24	99	98.6	37
54	53.6	12	77/78	77	25			

Appendix 2: Configuration of Connection Pipe

1. Standard length of connection pipe (More details please refer to the specifications.)

2. Min. length of connection pipe is 3m.

3. Max. length of connection pipe and max. high difference. (More details please refer to the specifications.)

4. The additional refrigerant oil and refrigerant charging required after prolonging connection pipe

- After the length of connection pipe is prolonged for 10m at the basis of standard length, you should add 5ml of refrigerant oil for each additional 5m of connection pipe.
- The calculation method of additional refrigerant charging amount (on the basis of liquid pipe):
- Basing on the length of standard pipe, add refrigerant according to the requirement as shown in the table. The additional refrigerant charging amount per meter is different according to the diameter of liquid pipe. See the following sheet.
- Additional refrigerant charging amount = prolonged length of liquid pipe X additional refrigerant charging amount per meter

Additional refrigerant charging amount for R32

Piping size		Indoor unit throttle	Outdoor unit throttle	
Liquid pipe	Gas pipe	Cooling only, cooling and heating (g / m)	Cooling only(g/m)	Cooling and heating(g/m)
1/4"	3/8" or 1/2"	14	12	16
1/4" or 3/8"	5/8" or 3/4"	40	12	40
1/2"	3/4" or 7/8"	80	24	96
5/8"	1" or 1 1/4"	136	48	96
3/4"	/	200	200	200
7/8"	/	280	280	280

Appendix 3: Pipe Expanding Method

⚠ Note:

Improper pipe expanding is the main cause of refrigerant leakage. Please expand the pipe according to the following steps:

A: Cut the pipe

- Confirm the pipe length according to the distance of indoor unit and outdoor unit.
- Cut the required pipe with pipe cutter.

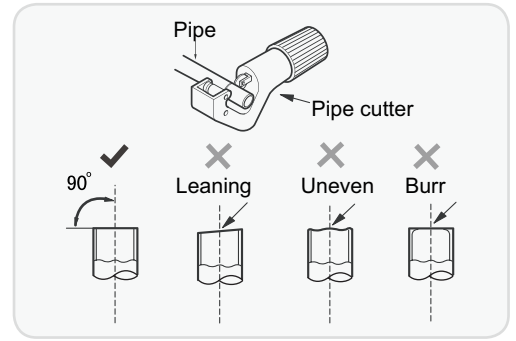

B: Remove the burrs

- Remove the burrs with shaper and prevent the burrs from getting into the pipe.

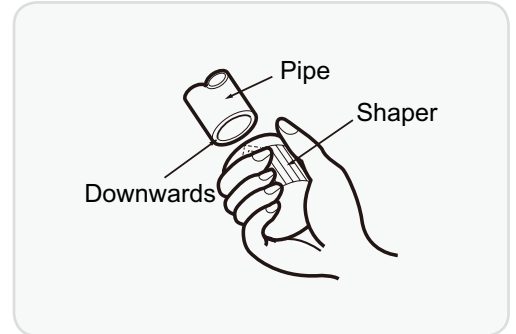

C: Put on suitable insulating pipe.

D: Put on the union nut

- Remove the union nut on the indoor connection pipe and outdoor valve; install the union nut on the pipe.

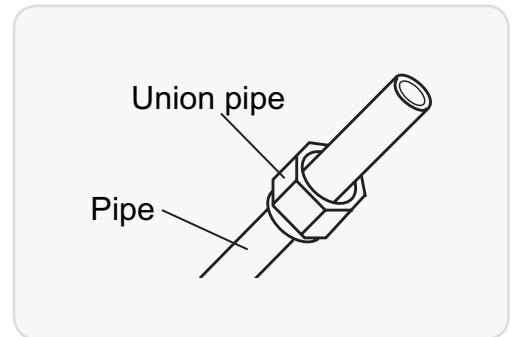

E: Expand the port

- Expand the port with expander.

⚠ Note:

- "A" is different according to the diameter, please refer to the sheet below:

Outer diameter(mm)	A(mm)	
	Max	Min
Φ6 - 6.35 (1/4")	1.3	0.7
Φ9 - Φ9.52 (3/8")	1.6	1.0
Φ12 - 12.70 (1/2")	1.8	1.0
Φ16 - 15.88 (5/8")	2.4	2.2

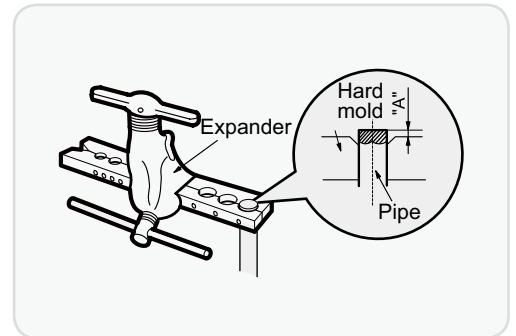

F: Inspection

- Check the quality of expanding port. If there is any blemish, expand the port again according to the steps above.

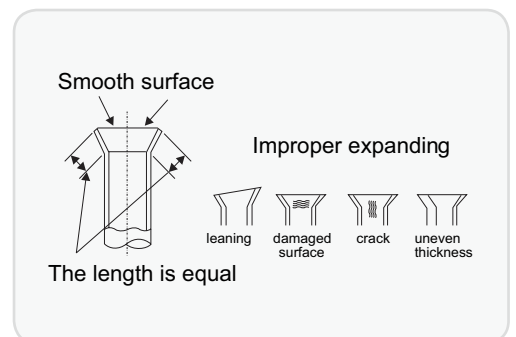

Appendix 4: List of Resistance for Temperature Sensor

Resistance Table of Ambient Temperature Sensor for Indoor and Outdoor Units(15K)

Temp(°C)	Resistance(kΩ)
-19	138.10
-18	128.60
-16	115.00
-14	102.90
-12	92.22
-10	82.75
-8	74.35
-6	66.88
-4	60.23
-2	54.31

Temp(°C)	Resistance(kΩ)
0	49.02
2	44.31
4	40.09
6	36.32
8	32.94
10	29.90
12	27.18
14	24.73
16	22.53
18	20.54

Temp(°C)	Resistance(kΩ)
20	18.75
22	17.14
24	15.68
26	14.36
28	13.16
30	12.07
32	11.09
34	10.20
36	9.38
38	8.64

Temp(°C)	Resistance(kΩ)
40	7.97
42	7.35
44	6.79
46	6.28
48	5.81
50	5.38
52	4.99
54	4.63
56	4.29
58	3.99

Resistance Table of Tube Temperature Sensors for Indoor and Outdoor (20K)

Temp(°C)	Resistance(kΩ)
-19	181.40
-15	145.00
-10	110.30
-5	84.61
0	65.37
5	50.87
10	39.87
15	31.47

Temp(°C)	Resistance(kΩ)
20	25.01
25	20.00
30	16.10
35	13.04
40	10.62
45	8.71
50	7.17
55	5.94

Temp(°C)	Resistance(kΩ)
60	4.95
65	4.14
70	3.48
75	2.94
80	2.50
85	2.13
90	1.82
95	1.56

Temp(°C)	Resistance(kΩ)
100	1.35
105	1.16
110	1.01
115	0.88
120	0.77
125	0.67
130	0.59
135	0.52

Resistance Table of Discharge Temperature Sensor for Outdoor(50K)

Temp(°C)	Resistance(kΩ)
-30	911.400
-25	660.8
-20	486.5
-15	362.9
-10	274
-5	209
0	161
5	125.1

Temp(°C)	Resistance(kΩ)
10	98
15	77.35
20	61.48
25	49.19
30	39.61
35	32.09
40	26.15
45	21.43

Temp(°C)	Resistance(kΩ)
50	17.65
55	14.62
60	12.17
65	10.18
70	8.555
75	7.224
80	6.129
85	5.222

Temp(°C)	Resistance(kΩ)
90	4.469
95	3.841
100	3.315
105	2.872
110	2.498
115	2.182
120	1.912
125	1.682



JF00304662



GREE ELECTRIC APPLIANCES, INC. OF ZHUHAI

Add: West Jinji Rd, Qianshan, Zhuhai, Guangdong, China, 519070

Tel: (+86-756) 8522219

Fax: (+86-756) 8669426

E-mail: global@cn.gree.com

For product improvement, specifications and appearance in this manual are subject to change without prior notice.