



Modbus Protocol (V1.5) for the Versati Heat Pump Water Heater

GREE ELECTRIC APPLIANCES, INC. OF ZHUHAI

In order to ensure the BMS integrated with the monitoring system of the Versati Water Heater, please read this manual carefully before installation and use and keep it propely for future reference.

CONTENTS

Preface	3
1. Terms and Definitions	3
2. Brief Introduction to the BMS System	4
3. Network Topology	4
3.1 General.....	4
3.2 Topological Structure	5
3.2.1 Topological Structure (<255)	5
3.2.2 Topological Structure (>255).....	5
4. MODBUS Protocol Format	5
4.1 General.....	5
4.2 Protocol Interface.....	5
4.3 Hardware Interface	5
4.4 Universal Communication Frame Format of Modbus under RTU Mode	8
4.5 ModBus Standard Protocol Format.....	8
4.5.1 Coil (Bit).....	8
4.5.2 Register (Word, 16 Bit)	9
4.5.3 Read Multiple Coils	9
4.5.4 Write Multiple Coils	9
4.5.5 Read Multiple Registers.....	10
4.5.6 Write Multiple Registers (Word)	10
4.5.7 Alarm Response.....	10
5. Communication Protocol for the Versati Heat Pump Water Heater.....	11
5.1. General.....	11
5.2. Precautions before Designing the BMS Interface	11
5.3. Valid Data for Modbus Communication	12
3. Precautions before the Use.....	23
Annex A.....	错误！未定义书签。
A.1 CRC Calculation Method	24
A.2 How to Calculate the CRC	24
A.3 CRC Example.....	24

Preface

This protocol specifies the communication format and also the data format for the Modbus communication of the Verstali heat pump water heater.

This protocol is applicable to the Verstali heat pump water heater.

1. Terms and Definitions

1) Modbus Communication

Modbus protocol is such a protocol used for industrial communication and distributed control system. Modbus network is a master-slave network, allowable for the communication between one master unit and multiple slave units through data interchange. The Modbus communication is realized in the request-response way, that is, each request sent by the master unit is corresponding to a response replied by the slave unit.

2) ASCII Mode

Under this mode, as for the communication via the Modbus, eight bits in one piece of information can be transmitted as two ASCII characters.

3) RTU Mode

Under this mode, eight bits can be divided into two four-bit hexadecimal characters. The advantage of the RTU mode is that with the same baud rate the transmitted character density is higher than that in the ASCII mode. Each piece of information should be transmitted continuously.

4) Master Unit

It indicates the device which sends out the request to Modbus, like a PC.

5) Slave Unit

It indicates such a device as is capable of responding to the request sent by the master unit, like a communication module which is taken as an example in this protocol.

6) Coil

It is expressed by one bit, like the switch bit, failure bit etc. The coil is a universal express way of the Modbus protocol and actually it is a one-bit data value, namely Boolean, switching value.

7) Register

It is expressed by two bytes (16 bits), like temperature, mode etc. The register is a universal express way of the Modbus protocol and actually it is a word (16 bits), or an analog value.

8) Device Address

It indicates the address of the Modbus communication module, through which the master unit can identify each communication module in the network. Address range: 1~255. "0" is the address of the broadcast (it can be received by all communication modules).

9) Broadcast

When the master unit sends out a control frame, all slave units in the network can receive it and then all perform this control action (but no reply is given). The device address for the broadcast frame is 0

10) Function Code

It is used to identify the function of the communication frame. See the following table for the function codes covered in this protocol.

Table 1 Function Code

Description	Function Code
Read Multiple Coils	0x01
Read Multiple Registers	0x03
Write Multiple Coils	0x0f

Write Multiple Registers	0x10
--------------------------	------

11) Starting Address

It indicates the starting address of the register (coil: bit address; register: word address). The data translation starts from the high-order eight bits to the low-order eight bits.

12) Data Size

It indicates the operated data count starting from the starting address (coil: bit count, register: word count). The data translation starts from the high-order eight bits to the low-order eight bits.

13) Byte Count

It indicates the count of the effective bytes during the data transmission.

14) Effective Data

It indicates the control data, status data etc.

15) Alarm Code

It indicates the error type which is detected by the communication module when the master unit is sending the request frame.

16) CRC

It indicates the cyclic redundancy code consisting of two bytes. The data translation starts from the low eight bits to the high-order eight bits. See Annex A for more details of its calculation.

17) Request Frame

It is the request sent by the master unit to the communication module.

18) Response Frame

It is the response replied by the communication module to the request frame sent by the master unit.

19) Communication Frame

It is the collection of continuously transmitted bytes during the communication.

20) BMS

Its full name is building management system

2. Brief Introduction to the BMS System

The interface RS485 of Modbus communication protocol, provided by the long-distance monitoring system, can be directly connected with the BMS system or Gree long-distance monitoring system, that is, control up to 255 units and display their running status at the same time. The control function of the BMS system is equal to that of the long-distance monitoring system. However, the command sent later takes the priority.

3. Network Topology**3.1 General**

As shown in Fig. 1, it can be seen that the whole network consists of two parts: units network and Modbus network

There are at most 255 communication modules in one monitoring network, that is, only 255 units can be connected.

When the quantity of the units is larger than 255, a new network can be established through another port which is also capable of connecting 255 communication modules.

3.2 Topological Structure

3.2.1 Topological Structure (<255)

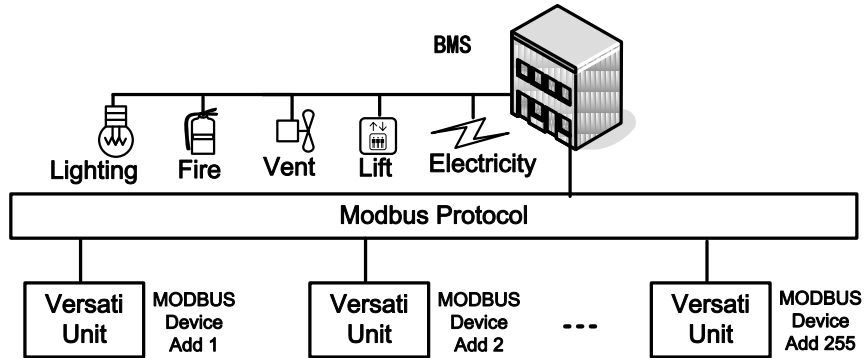

Figure 1: Topological Structure (<255)

3.2.2 Topological Structure (>255)

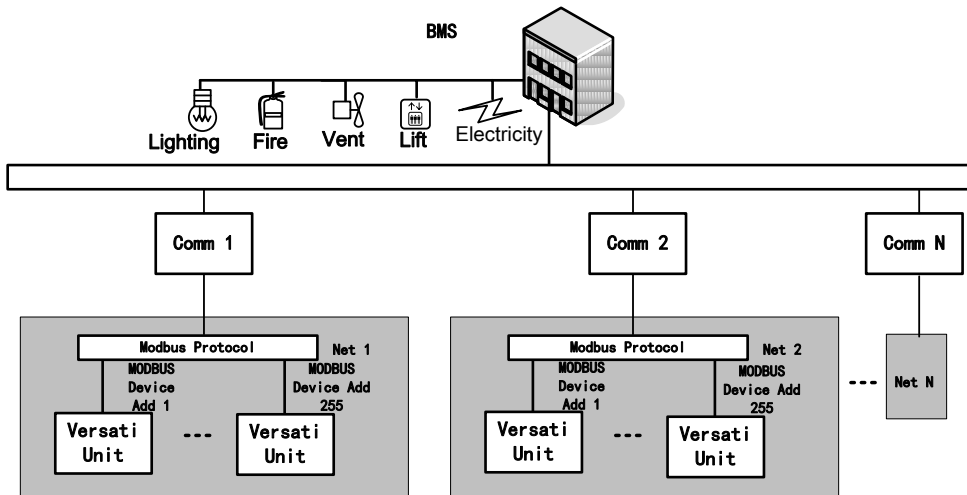

Figure 2: Topological Structure (255)

4. MODBUS Protocol Format

4.1 General

Modbus actually has become the industrial communication standard because it is not only fully opened and used widely but also simple and can be debugged flexibly. Besides, as for the communication of multiple units, it can be developed fast and also can be conveniently connected with the devices which support this protocol. There are two communication modes, RTU and ASCII. The former one is adopted for the BMS interface.

4.2 Protocol Interface

The protocol interface supports the Modbus RTU protocol.

4.3 Hardware Interface

- 1) Communication Interface: RS485
- 2) Baud Rate: 9600 bit/s (In some special event, other baud rate also can be selected but the communication mode should be compatible with this protocol)
 - ◆ Start Bit: 1
 - ◆ Data Bit: 8

- ◆ Check Bit: None
- ◆ Stop Bit: 1

3) Hardware interface of Wired Controller:

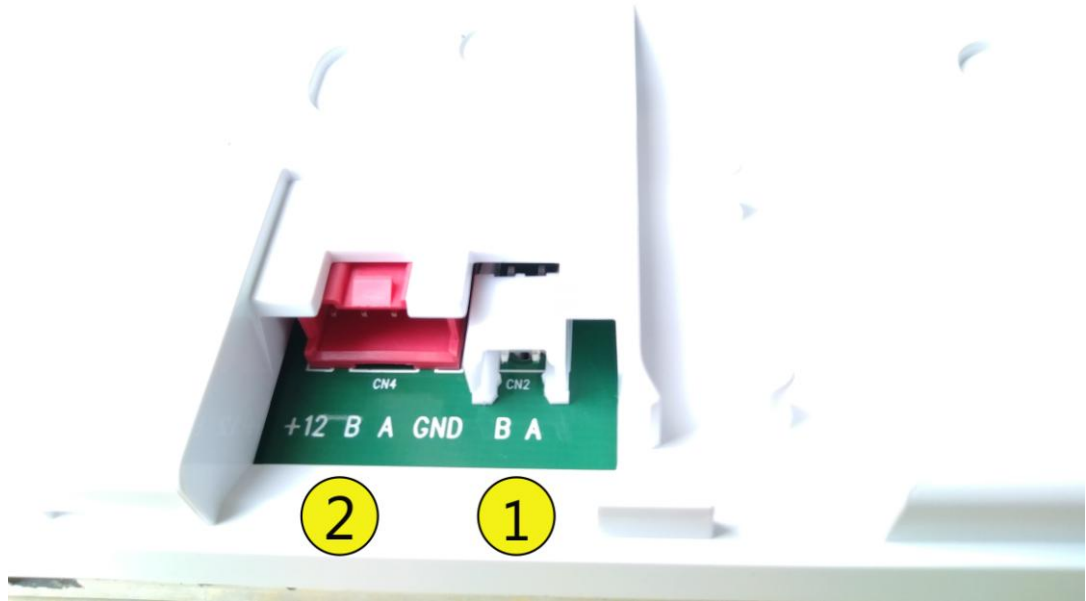

No.	Interface	Specifications	Instructions	Interfaces
1	BMS communication interface	Two-wire communication line, Class V twisted pairs, AWG24, non-standard	To be integrated into the BMS system	1—B 2—A
2	+12VDC interface+ Communication interface	Four-wire communication line, Class V twisted pairs, AWG24, 8m, standard.	To be integrated with the equipment communication line. +12VDC interface is powered through the equipment.	1—+12VDC 2—B 3—A 4—GND

Note: Interface 1 inputs/outputs RS-485 signals, please connect interface 1 into a RS-232 to RS-485 converter, and then integrate into the BMS system.

4) How to Set the BMS Address of the Controller:

Step 1: power the controller on, press "COMMISSION" to access to the "COMMISSION" page, and then press "FUNCTION" to go to the "FUNCTION" page.

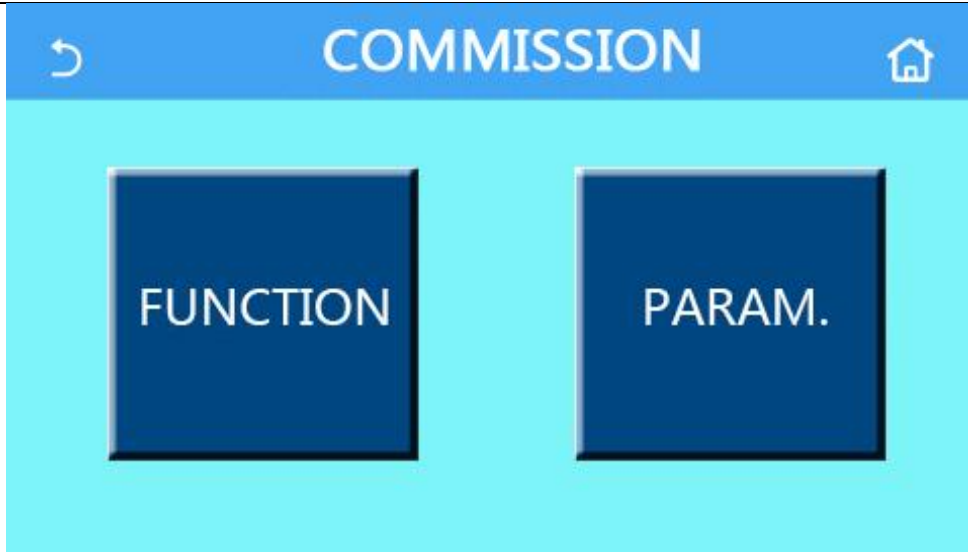

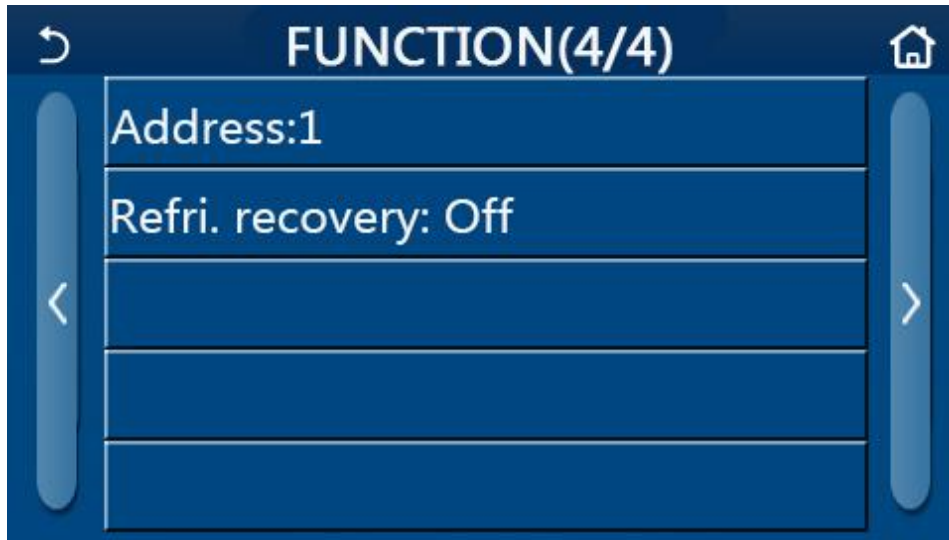

Step 2: press "Next" (the 1st from the right side) to go to the page where "Address" is.

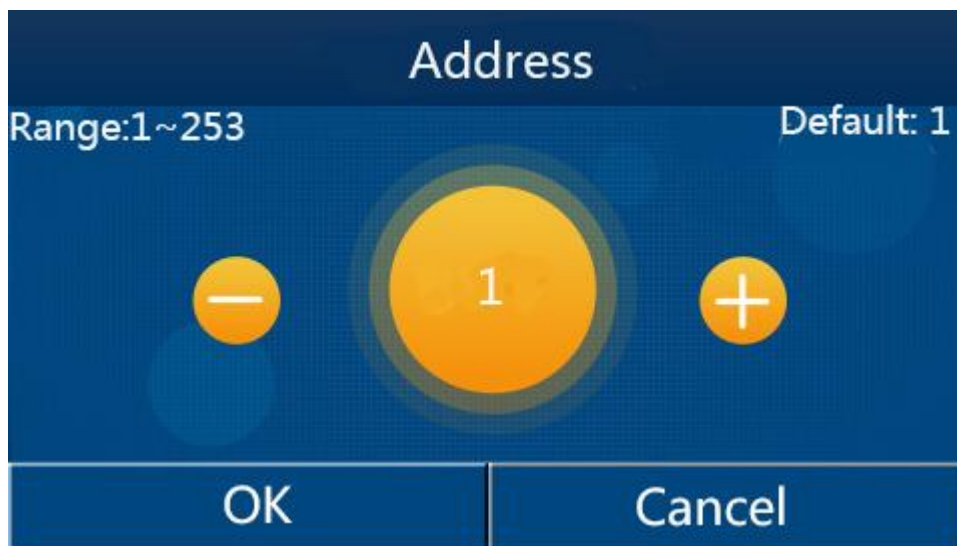

Step 3: Select the option "Address", and then go to the setting page.



Step 3: After that, press “” or “” to increase or decrease the “Address” value.

Step 4: Press “OK” to save the value.

Note: the “Address” can’t be 0 or 126. When the setting is finished, the address in the control command sent by the BMS software should be same as this setting value by the controller.

4.4 Universal Communication Frame Format of Modbus under RTU Mode

Start Time Interval	Add. Code	Function Code	Data Area	CRC	Stop Time Interval
T1-T2-T3-T4	1 Byte	1 Byte	n Bytes	2 Bytes	T1-T2-T3-T4

Under the RTU mode, there is at least 3.5 minutes dead time before the data transmission, which can be figured out through the adopted baud rate (like T1-T2-T3-T4 listed in the table above) and there is another 3.5 minutes dead time after the transmission of the last character. After that, another set of data can be transmitted. The whole set of data should be transmitted continuously, if there is a pause more than 1.5 minutes, the receiver will jump to the transmission of next set of data.

If the dead time is less than 3.5 minutes, the transmission would fail as the CRC for the information combination is ineffective.

4.5 ModBus Standard Protocol Format

4.5.1. Coil (Bit)

Table 2 Coil Data

Add	Corresponding Byte	Values
Bit 0	Byte0.0	1
Bit 1	Byte0.1	0
Bit 2	Byte0.2	1
Bit 3	Byte0.3	0
Bit 4	Byte0.4	1
Bit 5	Byte0.5	0
Bit 6	Byte0.6	1
Bit 7	Byte0.7	0
Bit 8	Byte1.0	1
Bit 9	Byte1.1	0
Bit 10	Byte1.2	1
Bit 11	Byte1.3	0
Bit 12	Byte1.4	1
Bit 13	Byte1.5	0
Bit 14	Byte1.6	1
Bit 15	Byte1.7	0
.....

- 1) “Coil” indicates the data of some flag bit or failure bit etc.
- 2) The unit of date is bit and each bit has a corresponding address.
- 3) The data bit exists in the byte of the communication frame and each byte is composed of eight bits. The high-order byte is corresponding to the high-order bit, so is the low-order byte and bit. See Table 2 for more details.
- 4) The master unit can operate one bit among the communication data or multiple continuous bits at the same time.

5) The bit count which the master unit can read or transmit is less than Byte×8. The ineffective data bit of the last byte should be cleared when transmit or read the effective data of the communication frame. For instance, when nine “1” bits are read or transmitted, then two bytes are need, “1111 1111” and “0000 0001”. For the later byte, the ineffective bits “0” should be cleared.

4.5.2 Register (Word, 16 Bit)

Table 3 Register Data

Add	Corresponding Byte	Value
Word 0	Byte 0	AA 55
	Byte 1	
Word 1	Byte 2	AA 55
	Byte 3	
Word 2	Byte 4	55 AA
	Byte 5	
.....
.....

- 1) ..The unit of the register is “word” which has a corresponding address starting from 0
- 2) ..When the master unit reads a word, it needs to read two bytes from the high-order eight bits to the low-order eight bits.
- 3) ..When the master unit transmits or read the request frame, it can transmit or read one or multiple continuous words in the data list.

4.5.3 Read Multiple Coils

Note: It can read the coil data but not support the broadcast.

Function Code: 0x01

Table 4: Request Frame

Device Add.	Function Code	Starting Add.	Data Size	CRC
1 Byte	1 Byte	2 Bytes	2 Bytes	2 Bytes

Table 5: Response Frame

Device Add.	Function Code	Byte Count	Effective Data	CRC
1 Byte	1 Byte	1 Byte	n Bytes	2 Bytes

Starting Address: it is the starting place where to read a series of bits.

Data size: It indicates the bit count.

Case: Read ten bits from the coil 5 of the device 10(see Table 2 for the coil data), as follows:

Request Frame: 0A(device address)01(function code)00 05(starting address)00 0A(data size)AD 77(CRC)

Response Frame: 0A(device address)01(function code)02(byte count)AA 02(effective data)E3 5C(CRC)

The last byte is “0000 0010”, among which six insignificant bits “0” before the bit “1” should be cleared

4.5.4 Write Multiple Coils

Note: The master writes coil data to the communication module and also supports the broadcast.

Function Code: 0x0F

Table 6: Request Frame

Device Add.	Function Code	Starting Add.	Data Size	Byte Count	Effective Data	CRC
1 Byte	1 Byte	2 Bytes	2 Bytes	1 Byte	n Bytes	2 Bytes

Table 7: Response Frame

Device Add.	Function Code	Starting Add.	Data Size	CRC
1 Byte	1 Byte	2 Bytes	2 Bytes	2 Bytes
Note: The response frame has the same device address, function code, starting address and data size as the request frame.				

Case: set eleven consecutive bits to "1" for the device 10 and start at the address 6, as follows:

Request Frame: 0A(device address)0F(function code)00 06 (starting address)00 0B(data size)02(byte count) FF 07 (effective data)97 A0(CRC)

Response Frame: 0A (device address) 0F (function code) 00 06(starting address) 00 0B (data size) F5 76(CRC)

The last byte is "0000 0010", among which the insignificant bits "0" before the bit "1" should be cleared.

4.5.5 Read Multiple Registers

Note: Read the register data but do not support the broadcast.

Function Code: 0x03

Table 8: Request Frame

Device Add.	Function Code	Starting Add.	Data Size	CRC
1 Byte	1 Byte	2 Bytes	2 Bytes	2 Bytes

Table 9: Response Frame

Device Add.	Function Code	Byte Count	Effective Date	CRC
1 Byte	1 Byte	1 Byte	n Bytes	2 Bytes

Starting Add.: It indicates the starting address to read the block data.

Data Size: It indicates the word count with the maximum of 127 each time.

Case: read two continuous words (see Table 3) from the device 10 starting at the address 1, as follows:

Request Frame: 0A (device address) 03 (function code) 00 01(starting address) 00 02(data size)94 B0 (CRC)

Response Frame: 0A (device address) 03 (function code) 04(byte count) AA 55 55 AA (effective data) CE 14(CRC)

4.5.6 Write Multiple Registers (Word)

Note: Write control data from the master unit to the register and support the broadcast

Function Code: 0x10

Table 10: Request Frame

Device Add.	Function Code	Starting Add.	Data Size	Byte Count	Effective Date	CRC
1 Byte	1 Byte	2 Bytes	2 Bytes	1 Byte	n Bytes	2 Bytes

Table 11: Response Frame

Device Add.	Function Code	Starting Add.	Data Size	CRC
1 Byte	1 Byte	2 Bytes	2 Bytes	2 Bytes
Note: The response frame has the same device address, function code, starting address and data size as the request frame.				

Case: Write three words (0x12, 0x23, 0x34) from the device 10 starting at the address 2, as follows:

Request Frame: 0A (device address) 10 (function code) 00 02(starting address) 00 03(data size) 06 (byte count) 00 12 00 23 00 34(effective data) 15 DF (CRC)

Response Frame: 0A (device address) 10 (function code) 00 02 (starting address) 00 03 (data size) 20 B3 (CRC)

4.5.7 Alarm Response

Note: The master unit sends out a request frame, but the communication module detects that there is some fault, so

an alarm response is replied.

Function Code: Set the highest-order bit to “1”, which is value figured out through the OR operation of the request frame’s function code and 0x80.

Communication Format of the Response Frame

Table12: Alarm Response Frame

Device Add.	Function Code	Alarm Code	CRC
1 Byte	1 Byte	1 Bytes	2 Bytes

Description to the Alarm Codes:

Table13: Alarm Codes

Alarm Code	Name	Description
0x03	Illegal data	The transmitted data is incorrect or beyond the data area.
0x02	Illegal address	The number of the transmitted data is incorrect.

Case: Read two words from the device 10 starting at the address 1, but the address 2 does not exist in the communication address, so the replay of the alarm response frame is as follows:

Request Frame: 0A (device address) 03(function code) 00 01(starting address) 00 02(data size) 94 B0 (CRC)

Reponses Frame: 0A (device address) 83(function code) 03(alarm code) 70 F3 (CRC)

5. Communication Protocol for the Versati Heat Pump Water Heater

5.1. General

Through this interface, it can not only realize the long-distance monitoring to the unit, including the running temperature of the unit, the status of the compressor, and the failure status but also set the unit long distantly, like temperature, running mode, on/off etc.

In the protocol, “R” indicates “only read” and “W/R” indicates “write and read”.

5.2. Precautions before Designing the BMS Interface

Before designing the BMS interface, please make sure the setting of the Address(do not set 0) and the wiring are correct and read *Installation and Operation Instructions of the Wired Controller of the Versati* heat pump water heater.

Please pay attention to the statements below.

- ★(1) Modes are allowed to be changed only when the unit is off, or this operation is ineffective. When the unit is off, “On/off” and “Mode” settings both are effective. However, when the unit is on, “On/off” and “Mode” settings both are effective and the monitoring software is suggested to tell this operation is invalid.
- ★(2): For the heating only unit, the “Cool” and “Cool+ Hot water” settings are ineffective and the monitoring software is suggested to tell this operation is invalid.
- ★(3): When the water tank is unavailable, the following points should be paid much attention.
 - a: “Cool+ Hot water” or “Heat+Hot water” or “Hot water” settings are ineffective and the monitoring software is suggested to tell this operation is invalid.
 - b:” Disinfection”, “Fast hot water”, “Cool+Hot water”, “Heat+ Hot water” settings are ineffective and the monitoring software is suggested to tell this operation is invalid.
- ★(4): Only when “Disinfection” is deactivated, “Set Temp” setting is effective. Similarly, only when the “Floor Debug” is

deactivated, “Floor Debug Sections”, “First Floor Debug Section Temp”, “Each Floor Debug Section Temp” or “Each Floor Debug Section Interval” settings are effective, or the monitoring software is suggested to tell this operation is invalid.

★(5): Disinfection: please read the *Installation and Operation Instructions of the Wired Controller of the Versati* heat pump water heater for details about the “Disinfection” function. When the command “Disinfection” is sent out, it is required to detect the “Disinfection” state (Word135) of the unit.

5.3. Valid Data for Modbus Communication

The data for the Modbus communication protocol can be divided into two types: register and switching value. The former indicates the values of temperature, valves and other continuous, multi-mode values, while the later indicates the value which only has two status, like the temperature sensor failure (with only two options: “Yes” or “No”).

1. Definition and Address of the Analog Variables (Word 0-Word 166)

Register (Read 03, Write 10)						
Add	Visit Type	Data	Range	Accuracy	Data Type	Note
Word 0	R	Reserved	/	/	/	
Word 1	R	Reserved	/	/	/	
Word 2	R/W	Mode	Actual value: 1:Heat/ 2:Hot water/ 3:Cool+Heat water/ 4:Heat +Hot water/ 5:Cool Default: Heat Transmission value=Actual value	/	Unsigned Integer	
Word 3	R/W	Optional E-Heater	Actual value: 1:1 set/ 2:2 sets/ 3: Off Default: 1 set Transmission value=Actual value	/	Unsigned Integer	Wired
Word 4	R/W	Disinfection Temp	Actual value:40~70℃, Default: 70℃ Transmission value = Actual value	1℃	Unsigned Integer	Control
Word 5	R/W	Floor Debug Segments	Actual value: 1-10 sections Default : 1 section Transmission value = Actual value	1 Section	Unsigned Integer	Register
Word 6	R/W	Floor Debug Period 1 temp	Actual value:25~35℃, Default: 25℃ Transmission value = Actual value	1℃	Unsigned Integer	Register
Word 7	R/W	△T of segment	Actual value:2~10℃, Default: 5℃ Transmission value = Actual value	1℃	Unsigned Integer	Register
Word 8	R/W	Segment time	Actual value: 12~72Hours, Default: 0 Hour Transmission value = Actual value	12 Hours	Unsigned Integer	Register
Word 9	R/W	WOT-Cool	Actual value: 7~25℃ Default: 18℃ Transmission value = Actual value	1℃	Unsigned Integer	Register



Modbus Protocol (V1.1) for the Versati Heat Pump Water Heater

Word 10	R/W	WOT-Heat	Actual value: 20~60℃ [High-temp] / 20~55℃ [low-temp] Default: 45℃ [High-temp]/45℃ [Low-temp] Transmission value = Actual value	1℃	Unsigned Integer
Word 11	R/W	RT-Cool	Actual value: 18~30℃, Default: 24℃ Transmission value = Actual value	1℃	Unsigned Integer
Word 12	R/W	RT-Heat	Actual value: 18~30℃, Default: 20℃ Transmission value = Actual value	1℃	Unsigned Integer
Word 13	R/W	T-water tank	Actual value: 40~80℃, Default: 50℃ Transmission value = Actual value	1℃	Unsigned Integer
Word 14	R/W	T-Eheater	Actual value: -20~18℃, Default: -15℃ Transmission value = Actual value	1℃	Unsigned Integer
Word 15	R/W	T-Other switch on	Actual value: -20~18℃, Default: -20℃ Transmission value = Actual value	1℃	Unsigned Integer
Word 16	R/W	T-HP max	Actual value: 40~55℃, Default: 50℃ Transmission value = Actual value	1℃	Unsigned Integer
Word 17	R/W	Upper AT-Heat	Actual value: 10~37℃, Default: 25℃ Transmission value = Actual value	1℃	Unsigned Integer
Word 18	R/W	Lower AT-Heat	Actual value: -20~9℃, Default: -20℃ Transmission value = Actual value	1℃	Unsigned Integer
Word 19	R/W	Upper RT-Heat	Actual value: 22~30℃, Default: 24℃ Transmission value = Actual value	1℃	Unsigned Integer
Word 20	R/W	Lower RT-Heat	Actual value: 18~21℃, Default: 18℃ Transmission value = Actual value	1℃	Unsigned Integer
Word 21	R/W	Upper WT-Heat	Actual value: 46~60℃ [High-temp]/ 46~55℃ [Low-temp] Default: 55℃ [High-temp]/55℃ [Low-temp] Transmission value = Actual value	1℃	Unsigned Integer
Word 22	R/W	Lower WT-Heat	Actual value: 20~45℃ Default: 40℃ Transmission value = Actual value	1℃	Unsigned Integer
Word 23	R/W	Upper AT-Cool	Actual value: 26~48℃, Default : 40℃ Transmission value = Actual value	1℃	Unsigned Integer
Word 24	R/W	Lower AT-Cool	Actual value: 10~25℃, Default : 25℃ Transmission value = Actual value	1℃	Unsigned Integer
Word 25	R/W	Upper RT-Cool	Actual value: 24~30℃, Default : 27℃ Transmission value = Actual value	1℃	Unsigned Integer



Modbus Protocol (V1.1) for the Versati Heat Pump Water Heater

Word 26	R/W	Lower RT-Cool	Actual value:18~23℃, Default : 22℃ Transmission value = Actual value	1℃	Unsigned Integer
Word 27	R/W	Upper WT-Cool	Actual value: 15~25℃ [with FCU] Default : 15℃ Transmission value = Actual value	1℃	Unsigned Integer
Word 28	R/W	Lower WT-Cool	Actual value: 7~14℃ Default : 7℃ Transmission value = Actual value	1℃	Unsigned Integer
Word 29	R/W	△T-Cool	Actual value: 2~10℃, Default :5℃ Transmission value = Actual value	1℃	Unsigned Integer
Word 30	R/W	△T-Heat	Actual value: 2~10℃, Default :10℃ Transmission value = Actual value	1℃	Unsigned Integer
Word 31	R/W	△T-hot water	Actual value:2~8℃, Default :5℃ Transmission value = Actual value	1℃	Unsigned Integer
Word 32	R/W	△T-Room temp	Actual value:1~5℃, Default :2℃ Transmission value = Actual value	1℃	Unsigned Integer
Word 33	R/W	Cool run time	Actual value:1~10min Default :3min Transmission value = Actual value	1min	Unsigned Integer
Word 34	R/W	Heat run time	Actual value:1~10min Default :5min Transmission value = Actual value	1min	Unsigned Integer
Word 35	R/W	Other thermal logic	Actual value:1~3 Default :1 Transmission value = Actual value	/	Unsigned Integer
Word 36	R/W	Tank heater	Actual value:1~2 Default :1 Transmission value = Actual value	/	Unsigned Integer
Word 37	R/W	Optional E-Heater logic	Actual value:1~2 Default :1 Transmission value = Actual value	/	Unsigned Integer
Word 38	R/W	Current limit value	Actual value:0~50A Default :16A Transmission value = Actual value	1A	Unsigned Integer
Word 39	R/W	Thermostat	Actual value: 0: Without/ 1: Air / 2: Air+hot water Default: Without Transmission value=Actual value	/	Unsigned Integer
Word 40	R/W	Force mode	Actual value: 1: Force-cool/ 2: Force-heat / 3: Off Default: Off Transmission value=Actual value	/	Unsigned Integer
Word 41	R/W	Air removal	Actual value: 1: Air / 2: Water tank/ 3: Off	/	Unsigned Integer



Modbus Protocol (V1.1) for the Versati Heat Pump Water Heater

			Default: Off Transmission value=Actual value		
Word 42	R/W	On/Off	Actual value: 0xAA:On/ 0x55:Off Default: Off Transmission value=Actual value	/	Unsigned Integer
Word 43	R/W	Power limit	Actual value:0~10 Kw Default :3 Kw Transmission value= Actual value * 10	0.1 Kw	Unsigned Integer
Word 44	R/W	Error reset	0: Does not clear fault 1: Clear fault	/	Unsigned Integer
Word 45	/	Reserved	/	/	/
Word 46	/	Reserved	/	/	/
Word 47	/	Reserved	/	/	/
Word 48	/	Reserved	/	/	/
Word 49	/	Reserved	/	/	/
Word 50	/	Reserved	/	/	/
Word 51	/	Reserved	/	/	/
Word 52	/	Reserved	/	/	/
Word 53	/	Reserved	/	/	/
Word 54	/	Reserved	/	/	/
Word 55	/	Reserved	/	/	/
Word 56	/	Reserved	/	/	/
Word 57	/	Reserved	/	/	/
Word 58	/	Reserved	/	/	/
Word 59	/	Reserved	/	/	/
Word 60	/	Reserved	/	/	/
Word 61	/	Reserved	/	/	/
Word 62	/	Reserved	/	/	/
Word 63	/	Reserved	/	/	/
Word 64	/	Reserved	/	/	/
Word 65	/	Reserved	/	/	/
Word 66	/	Reserved	/	/	/
Word 67	/	Reserved	/	/	/
Word 68	/	Reserved	/	/	/
Word 69	/	Reserved	/	/	/
Word 70	/	Reserved	/	/	/
Word 71	/	Reserved	/	/	/
Word 72	/	Reserved	/	/	/



Modbus Protocol (V1.1) for the Versati Heat Pump Water Heater

Word 73	/	Reserved	/	/	/
Word 74	/	Reserved	/	/	/
Word 75	/	Reserved	/	/	/
Word 76	/	Reserved	/	/	/
Word 77	/	Reserved	/	/	/
Word 78	/	Reserved	/	/	/
Word 79	/	Reserved	/	/	/
Word 80	/	Reserved	/	/	/
Word 81	/	Reserved	/	/	/
Word 82	/	Reserved	/	/	/
Word 83	/	Reserved	/	/	/
Word 84	/	Reserved	/	/	/
Word 85	/	Reserved	/	/	/
Word 86	/	Reserved	/	/	/
Word 87	/	Reserved	/	/	/
Word 88	/	Reserved	/	/	/
Word 89	/	Reserved	/	/	/
Word 90	/	Reserved	/	/	/
Word 91	/	Reserved	/	/	/
Word 92	/	Reserved	/	/	/
Word 93	/	Reserved	/	/	/
Word 94	/	Reserved	/	/	/
Word 95	/	Reserved	/	/	/
Word 96	/	Reserved	/	/	/
Word 97	/	Reserved	/	/	/
Word 98	/	Reserved	/	/	/
Word 99	/	Reserved	/	/	/
Word 100	/	Reserved	/	/	/
Word 101	/	Reserved	/	/	/
Word 102	/	Reserved	/	/	/
Word 103	/	Reserved	/	/	/
Word 104	/	Reserved	/	/	/
Word 105	/	Reserved	/	/	/
Word 106	/	Reserved	/	/	/
Word 107	/	Reserved	/	/	/
Word 108	/	Reserved	/	/	/
Word109	/	Reserved	/	/	/
Word 110	/	Reserved	/	/	/
Word 111	/	Reserved	/	/	/
Word 112	/	Reserved	/	/	/
Word 113	/	Reserved	/	/	/
Word 114	/	Reserved	/	/	/
Word 115	/	Reserved	/	/	/
Word 116	/	Reserved	/	/	/



Modbus Protocol (V1.1) for the Versati Heat Pump Water Heater

Word 117	R	Unit status	01: Cool/ 02: Heat/ 06: Hot water/ 08: Off/ Default: / Transmission value=Actual value	/	Unsigned Integer	O u t d o o r U n i t I n d o o r U n i t
Word 118	R	T-outdoor	Actual value: -30~150℃ Default: / Transmission value=Actual value	1℃	Unsigned Integer	
Word 119	R	T-discharge	Actual value: -30~150℃ Default: / Transmission value=Actual value	1℃	Unsigned Integer	
Word 120	R	T-defrost	Actual value: -30~150℃ Default: / Transmission value=Actual value	1℃	Unsigned Integer	
Word 121	R	T-suction	Actual value: -30~150℃ Default: / Transmission value=Actual value	1℃	Unsigned Integer	
Word 122	R	T-economizer in	Actual value: -30~150℃ Default: / Transmission value=Actual value	1℃	Unsigned Integer	
Word 123	R	T-economizer out	Actual value: -30~150℃ Default: / Transmission value=Actual value	1℃	Unsigned Integer	
Word 124	R	Dis. pressure	Actual value: -40~70℃ Default: / Transmission value=Actual value	1℃	Unsigned Integer	
Word 125	R	T-water out PE	Actual value: -30~150℃ Default: / Transmission value=Actual value	1℃	Unsigned Integer	
Word 126	R	T-optional water sen.	Actual value: -30~150℃ Default: / Transmission value=Actual value	1℃	Unsigned Integer	
Word 127	R	T-water in PE	Actual value: -30~150℃ Default: / Transmission value=Actual value	1℃	Unsigned Integer	
Word 128	R	T-tank ctrl.	Actual value: -30~150℃ Default: / Transmission value=Actual value	1℃	Unsigned Integer	
Word 129	R	T-remote room	Actual value: -30~150℃ Default: / Transmission value=Actual value	1℃	Unsigned Integer	
Word 130	R	T-gas pipe	Actual value: -30~150℃ Default: / Transmission value=Actual value	1℃	Unsigned Integer	
Word 131	R	T-liquid pipe	Actual value: -30~150℃ Default: / Transmission value=Actual value	1℃	Unsigned Integer	
Word 132	R	Thermostat	Actual value: 1: Cool/ 2: Heat/ 3: Off Default: / Transmission value=Actual value	/	Unsigned Integer	
Word 133	R	T-floor debug	/ Actual value: actual calculated value Default: / Transmission value=Actual value	1℃	Unsigned Integer	
Word 134	R	Debug time	/ Actual value: actual calculated value	1H	Unsigned	



Modbus Protocol (V1.1) for the Versati Heat Pump Water Heater

			Default: / Transmission value = Actual value		Integer
Word 135	R	Disinfection	Actual value: 1: Running/ 2: Done/ 3: Failed/ 0: Off Default: / Transmission value = Actual value	/	Unsigned Integer
Word 136	R	Error Time for Floor Debug	Actual value: actual calculated value Default: / Transmission value = Actual value	1Sec	Unsigned Integer
Word 137	R	T-weather depend	Actual value: actual calculated value Default: / Transmission value = Actual value	1°C	Unsigned Integer
Word 138	/	Reserved	/	/	/
Word 139	/	Reserved	/	/	/
Word 140	/	Reserved	/	/	/
Word 141	/	Reserved	/	/	/
Word 142	R	Setting frequency	Actual value: 0~100 Hz Default: 0 Transmission value = Actual value	1 Hz	Unsigned Integer
Word 143	R	Running frequency	Actual value: 0~100 Hz Default: 0 Transmission value = Actual value	1 Hz	Unsigned Integer
Word 144	/	Reserved	/	/	/
Word 145	/	Reserved	/	/	/
Word 146	/	Reserved	/	/	/
Word 147	/	Reserved	/	/	/
Word 148	/	Reserved	/	/	/
Word 149	/	Reserved	/	/	/
Word 150	/	Reserved	/	/	/
Word 151	/	Reserved	/	/	/
Word 152	/	Reserved	/	/	/
Word 153	/	Reserved	/	/	/
Word 154	/	Reserved	/	/	/
Word 155	/	Reserved	/	/	/
Word 156	/	Reserved	/	/	/
Word 157	/	Reserved	/	/	/
Word 158	/	Reserved	/	/	/
Word 159	/	Reserved	/	/	/
Word 160	/	Reserved	/	/	/
Word 161	/	Reserved	/	/	/
Word 162	/	Reserved	/	/	/
Word 163	/	Reserved	/	/	/
Word 164	/	Reserved	/	/	/
Word 165	/	Reserved	/	/	/
Word 166	/	Reserved	/	/	/

2. Definition and Address of State Variables (Bit 0-Bit 199)

Byte Add	Visit Type	Bit Add	Data		Data Type	Note
Byte 0	/	Bit 0	Reserved	/	/	
	/	Bit 1	Reserved	/	/	
	/	Bit 2	Reserved	/	/	
	/	Bit 3	Reserved	/	/	
	/	Bit 4	Reserved	/	/	
	/	Bit 5	Reserved	/	/	
	/	Bit 6	Reserved	/	/	
	/	Bit 7	Reserved	/	/	
Byte 1	W/R	Bit 8	Weekly Timer	0:Close/1:Open	State Variable	Wired Controller
	W/R	Bit 9	Clock Timer	0:Close/1:Open	State Variable	
	W/R	Bit 10	Temp Timer	0:Close/1:Open	State Variable	
	W/R	Bit 11	Gate-Ctrl.	0:Close/1:Open	State Variable	
	/	Bit 12	Reserved	/	/	
	/	Bit 13	Reserved	/	/	
	/	Bit 14	Reserved	/	/	
	/	Bit 15	Reserved	/	/	
Byte 2	W/R	Bit 16	Solar heater	0:Off/1:On	State Variable	Wired Controller
	W/R	Bit 17	Ctrl.state	0:T-water out/1:T-room	State Variable	
	W/R	Bit 18	Fast Hot Water	0:Off/1:On	State Variable	
	W/R	Bit 19	Cool+Hot Water Priority	0:Cool/1:Hot water	State Variable	
	W/R	Bit 20	Heat+Hot Water Priority	0:Heat/1:Hot water	State Variable	
	W/R	Bit 21	Quite Mode	0: Off/1: On	State Variable	
	W/R	Bit 22	Weather depend	0: Off/1: On	State Variable	
	W/R	Bit 23	Disinfection	0: Off/1: On	State Variable	
Byte 3	W/R	Bit 24	Floor Debug	0: Off/1: On	State Variable	Wired Controller
	W/R	Bit 25	Floor Debug start/stop	0: Stop/1: Start	State Variable	
	W/R	Bit 26	Emergen. mode	0: Off/1: On	State Variable	
	W/R	Bit 27	Other thermal	0: Without/1: With	State Variable	
	W/R	Bit 28	Reserved	/	State Variable	
	W/R	Bit 29	Water Tank	0: Without/1: With	State Variable	
	W/R	Bit 30	Reserved	/	State Variable	
	W/R	Bit 31	Solar setting	0: Without/1: With	State Variable	
Byte 4	W/R	Bit 32	Reserved	/	State Variable	Wired Controller Outdoor Unit
	W/R	Bit 33	Remote sensor	0: Without/1: With	State Variable	
	W/R	Bit 34	Holiday Mode	0: Off/1: On	State Variable	
	W/R	Bit 35	Refri. recovery	0: Off/1: On	State Variable	
	W/R	Bit 36	Manual defrost	0: Off/1: On	State Variable	
	W/R	Bit 37	Cool 2-Way valve	0: Off/1: On	State Variable	
	R	Bit 38	Heat 2-Way valve	0: Off/1: On	/	
	R	Bit 39	Reserved	/	/	
Byte 5	/	Bit 40	Reserved	/	/	
	/	Bit 41	Reserved	/	/	
	/	Bit 42	Reserved	/	/	



Modbus Protocol (V1.1) for the Versati Heat Pump Water Heater

	/	Bit 43	Reserved	/	/	
	/	Bit 44	Reserved	/	/	
	/	Bit 45	Reserved	/	/	
	/	Bit 46	Reserved	/	/	
	/	Bit 47	Reserved	/	/	
Byte 6	/	Bit 48	Reserved	/	/	
	/	Bit 49	Reserved	/	/	
	/	Bit 50	Reserved	/	/	
	/	Bit 51	Reserved	/	/	
	/	Bit 52	Reserved	/	/	
	/	Bit 53	Reserved	/	/	
	/	Bit 54	Reserved	/	/	
Byte 7	/	Bit 55	Reserved	/	/	
	/	Bit 56	Reserved	/	/	
	/	Bit 57	Reserved	/	/	
	/	Bit 58	Reserved	/	/	
	/	Bit 59	Reserved	/	/	
	/	Bit 60	Reserved	/	/	
	/	Bit 61	Reserved	/	/	
Byte 8	R	Bit 62	Reserved	/	/	
	R	Bit 63	Reserved	/	/	
	R	Bit 64	Communication Error between the Wired Controller and IDU	1: Error; 0:Normal	Error	Wired Controller
	R	Bit 65	Communication Error between the Wired Controller and ODU	1: Error; 0:Normal	Error	
	R	Bit 66	Communication Error between the Wired Controller and Drive	1: Error; 0:Normal	Error	
	R	Bit 67	HP-Antifree	0: Off; 1: On	Error	
	R	Bit 68	Reserved	/	/	
	R	Bit 69	Reserved	/	/	
R	Bit 70	Reserved	/	/		
R	Bit 71	Reserved	/	/		
Byte 9	R	Bit 72	Reserved	/	/	
	R	Bit 73	Reserved	/	/	
	R	Bit 74	Reserved	/	/	
	R	Bit 75	Reserved	/	/	
	R	Bit 76	Reserved	/	/	
	R	Bit 77	Reserved	/	/	
	R	Bit 78	Reserved	/	/	
Byte 10	R	Bit 79	Reserved	/	/	
	R	Bit 80	Compressor State	1: On; 0: Off	State Variable	Outdoor Unit
	R	Bit 81	ODU Fan State	1: On; 0: Off	State Variable	
	R	Bit 82	Reserved	0	State Variable	
	R	Bit 83	4-way Valve State	1: On; 0: Off	State Variable	
	R	Bit 84	Compressor Crankcase Heater State	1: On; 0: Off	State Variable	
R	Bit 85	Underpan Heater State	1: On; 0: Off	State Variable		



Modbus Protocol (V1.1) for the Versati Heat Pump Water Heater

	R	Bit 86	Defrosting State	0: End; 1: Defrosting;	State Variable	
	R	Bit 87	Oil Return State	0: No oil return; 1: In oil return	State Variable	
Byte 11	R	Bit 88	Ambient Temp Sensor Error	1: Error; 0:Normal	Error	Outdoor Unit
	R	Bit 89	Defrost Temp Sensor Error	1: Error; 0:Normal	Error	
	R	Bit 90	Discharge Temp Sensor Error	1: Error; 0:Normal	Error	
	R	Bit 91	Suction Temp Sensor Error	1: Error; 0:Normal	Error	
	R	Bit 92	ODU Fan Error	1: Error; 0:Normal	Error	
	R	Bit 93	High-Pressure Sensor Error	1: Error; 0:Normal	Error	
	R	Bit 94	High Pressure Protection	1: Error; 0:Normal	Error	
Byte 12	R	Bit 95	Low Pressure Protection	1: Error; 0:Normal	Error	Outdoor Unit
	R	Bit 96	High Discharge Protection	1: Error; 0:Normal	Error	
	R	Bit 97	Capacity DIP Setting Error	1: Error; 0:Normal	Error	
	R	Bit 98	Communication Error between IDU and ODU	1: Error; 0:Normal	Error	
	/	Bit 99	Economizer In Sensor Error	1: Error; 0:Normal	State Variable	
	/	Bit 100	Economizer Out Sensor Error	1: Error; 0:Normal	State Variable	
	R	Bit 101	Reserved	0	Error	
R	Bit 102	System Recoverable Protection	1: Yes, 0: NO	Error		
R	Bit 103	System Irrecoverable Protection	1: Yes; 0: No	Error		
Byte 13	R	Bit 104	Reserved	0	Error	Outdoor Unit
	/	Bit 105	Reserved	0	/	
	R	Bit 106	Reserved	0	Error	
	/	Bit 107	Reserved	0	/	
	R	Bit 108	Flow Switch Protection	1: protected, 0: Normal	Error	
	R	Bit 109	4-way valve	1: Yes; 0: No	Error	
	/	Bit 110	Reserved	0	/	
/	Bit 111	Reserved	0	/		
Byte 14	/	Bit 112	Reserved	0	/	
	/	Bit 113	Reserved	0	/	
	/	Bit 114	Reserved	0	/	
	/	Bit 115	Reserved	0	/	
	/	Bit 116	Reserved	0	/	
	/	Bit 117	Reserved	0	/	
	/	Bit 118	Reserved	0	/	
Byte 15	/	Bit 119	Reserved	0	/	
	/	Bit 120	Reserved	0	/	
	/	Bit 121	Reserved	0	/	
	/	Bit 122	Reserved	0	/	
	/	Bit 123	Reserved	0	/	
	/	Bit 124	Reserved	0	/	
	/	Bit 125	Reserved	0	/	
Byte 16	R	Bit 126	Reserved	0	/	Outdoor Unit
	R	Bit 127	Reserved	0	/	
Byte 16	R	Bit 128	DC Bus Low-voltage or Voltage Drop	1: Error; 0:Normal	Error	Outdoor Unit
	R	Bit 129	DC Bus Over-voltage	1: Error; 0:Normal	Error	



Modbus Protocol (V1.1) for the Versati Heat Pump Water Heater

	R	Bit 130	AC Current Protection (Input Side)	1: Error; 0:Normal	Error	
	R	Bit 131	IPM Error	1: Error; 0:Normal	Error	
	R	Bit 132	PFC Error	1: Error; 0:Normal	Error	
	R	Bit 133	Startup Error	1: Error; 0:Normal	Error	
	R	Bit 134	Phase Loss	1: Error; 0:Normal	Error	
	R	Bit 135	Drive Module Resetting	1: Error; 0:Normal	Error	
Byte 17	R	Bit 136	Compressor Overcurrent	1: Error; 0:Normal	Error	Outdoor Unit
	R	Bit 137	Over-speed	1: Error; 0:Normal	Error	
	R	Bit 138	Charging Circuit Error or Current Sensor Error	1: Error; 0:Normal	Error	
	R	Bit 139	Desynchronizing	1: Error; 0:Normal	Error	
	R	Bit 140	Compressor Stalling	1: Error; 0:Normal	Error	
	R	Bit 141	Drive Communication Error	1: Error; 0:Normal	Error	
	R	Bit 142	Radiator or IPM or PFC Over-temperature	1: Error; 0:Normal	Error	
Byte 18	/	Bit 144	Reserved	0	State Variable	Outdoor Unit
	/	Bit 145	Reserved	0	State Variable	
	R	Bit 146	Charging Circuit Error	1: Error; 0:Normal	Error	
	R	Bit 147	AC Input Voltage Error	1: Error; 0:Normal	Error	
	R	Bit 148	Drive Board Temp Sensor Error	1: Error; 0:Normal	Error	
	R	Bit 149	AC Contactor Protection or Input Cross-zero Error	1: Error; 0:Normal	Error	
	R	Bit 150	Temp Drift Protection	1: Error; 0:Normal	Error	
Byte 19	R	Bit 151	Sensor Connection Protection (Connection to Phase U or V failed)	1: Error; 0:Normal	Error	Indoor Unit
	R	Bit 152	Condenser Leaving Water Temp Sensor Error	1: Error; 0:Normal	Error	
	R	Bit 153	E-heater Leaving Water Temp Sensor Error	1: Error; 0:Normal	Error	
	R	Bit 154	Refrigerant Liquid Temp Sensor Error	1: Error; 0:Normal	Error	
	R	Bit 155	Condenser Entering Water Temp Sensor Error	1: Error; 0:Normal	Error	
	R	Bit 156	Water Tank Temp Sensor Error	1: Error; 0:Normal	Error	
	R	Bit 157	Reserved	0	Error	
	R	Bit 158	Refrigerant Vapor Line Temp Sensor Error	1: Error; 0:Normal	Error	
Byte 20	R	Bit 159	Reserved	0	Error	Indoor Unit
	R	Bit 160	Remote Room Temp Sensor Error	1: Error; 0:Normal	Error	
	R	Bit 161	Reserved	0	Error	
	/	Bit 162	Reserved	0	/	
	/	Bit 163	Reserved	0	/	
	R	Bit 164	Reserved	0	State Variable	
	R	Bit 165	Reserved	0	State Variable	
	R	Bit 166	Reserved	0	State Variable	
/	Bit 167	Reserved	0	/		



Modbus Protocol (V1.1) for the Versati Heat Pump Water Heater

Byte 21	R	Bit 168	Reserved	0	/	Indoor Unit
	R	Bit 169	Other Heat Source State	1: On, 0: Off	State Variable	
	R	Bit 170	Flow Switch State	1: Open, 0: Close	State Variable	
	R	Bit 171	IDU E-heater 1 State	1: On, 0: Off	State Variable	
	R	Bit 172	IDU E-heater 2 State	1: On, 0: Off	State Variable	
	R	Bit 173	Water Tank Heater State	1: On, 0: Off	State Variable	
	R	Bit 174	Reserved	0	/	
	R	Bit 175	IDU Water Pump State	1: On, 0: Off	State Variable	
Byte 22	R	Bit 176	Circulating 2-way Valve State	1: On, 0: Off	State Variable	Indoor Unit
	/	Bit 177	Plate Heater State	1: On, 0: Off	State Variable	
	/	Bit 178	3-way Valve State	1: On, 0: Off	State Variable	
	R	Bit 179	Gate-Ctrl	1: Card in; 0: Card out	State Variable	
	R	Bit 180	Reserved	0	/	
	R	Bit 181	Reserved	0	/	
	/	Bit 182	Reserved	0	/	
	/	Bit 183	Reserved	0	/	
Byte 23	/	Bit 184	Jumper cap Error	1: Error; 0: Normal	Error	Indoor Unit
	R	Bit 185	E-heater 1 Welding Protection	1: protected, 0: Normal	Error	
	R	Bit 186	E-heater 2 Welding Protection	1: protected, 0: Normal	Error	
	R	Bit 187	Water Heater Welding Protection	1: protected, 0: Normal	Error	
	R	Bit 188	Water Flow Protection	1: Yes, 0: No	Error	
	/	Bit 189	Reserved	0	/	
	R	Bit 190	IDU Recoverable Protection	1: Yes, 0: No	Error	
	R	Bit 191	IDU Irrecoverable Protection	1: Yes, 0: No	Error	
Byte 24	/	Bit 192	Reserved	0	/	
	/	Bit 193	Reserved	0	/	
	/	Bit 194	Reserved	0	/	
	/	Bit 195	Reserved	0	/	
	/	Bit 196	Reserved	0	/	
	/	Bit 197	Reserved	0	/	
	/	Bit 198	Reserved	0	/	
	/	Bit 199	Reserved	0	/	

3. Precautions before the Use

- 1) Make sure the proper adapter is used; or normal communication would fail.
- 2) Reinforce the stability of the communication cord through soldering and insulate it with the insulating tape to prevent oxidation and short circuit.
- 3) Modification to all parameter with the memory function activated will work immediately but will be memorized in 30 minutes.

CRC Calculation Method

(Normative)

A.1 CRC Calculation Method

Calculation Method of CRC: The CRC is first preloading a 16-bit register to all 1's. Then successively transact each 8-bit bytes of the message. During generation of the CRC, each 8-bit character is exclusive ORed with the register contents. Then the result is shifted in the direction of the least significant bit (LSB), with a zero filled into the most significant bit (MSB) position. The LSB is extracted and examined. If the LSB was a 1, the register is then exclusive ORed with a preset, fixed value. If the LSB was a 0, no exclusive OR takes place. This process is repeated until eight shifts have been performed. After the last (eighth) shift, the next 8-bit character is exclusive ORed with the register's current value, and the process repeats for eight more shifts as described above. The final contents of the register, after all the characters of the message have been applied, is the CRC value. During transmission and reception of data in CRC, low order byte is in the front.

A.2 How to Calculate the CRC

- 1) Preload a 16-bit register with FFFF hex (all 1's) and Call this the CRC register.
- 2) Exclusive OR the first 8-bit byte of the message with the low-order byte of the 16-bit CRC register, and put the result in the CRC registers.
- 3) Shift the CRC register one bit to the right (toward the LSB), zero-filling the MSB. Extract and examine the LSB
- 4) (If the LSB was 0): Repeat Step 3 (another shift). (If the LSB was 1): Exclusive OR the CRC register with the polynomial value A001 (1010 0000 0000 0001).
- 5) Repeat Steps 3 and 4 until 8 shifts have been performed. When this is done, a complete 8-bit byte will have been processed
- 6) Repeat Steps 2 and 5 to process the next 8-bit data.
- 7) The final obtained CRC register is CRC.

A.3 CRC Example

Parameters: Data (starting address of the block data), Data Size (Byte count of the block data)

Return: CRC Calculatin Result

```
uint16 CRC_Calculate(uint8 *data, uint16 dataSize)
{
    uint8 i;
    uint8 temp;
    uint16 j;
    uint16 CRCCode;
    CRCCode=0xffff;
    for(j=0;j<dataSize;j++){
        CRCCode = CRCCode^data[j];
        for( i = 0; i < 8; i++){
            temp = CRCCode & 0x0001;
            CRCCode = (CRCCode >> 1);
            if(temp ==1){
                CRCCode = (CRCCode^0xA001);// 0xA001 is a preset multinomial, a constant.
            }
        }
    }
    return CRCCode;
}
```