



Owner's Manual

Original Instructions 
Air Conditioners

Air-to-water Heat Pump

GRS-CQ4.0Pd/NhG3-E	GRS-CQ4.0Pd/NhG4-E
GRS-CQ6.0Pd/NhG3-E	GRS-CQ6.0Pd/NhG4-E
GRS-CQ8.0Pd/NhG3-E	GRS-CQ8.0Pd/NhG4-E
GRS-CQ10Pd/NhG3-E	GRS-CQ10Pd/NhG4-E
GRS-CQ8.0Pd/NhG3-M	GRS-CQ8.0Pd/NhG4-M
GRS-CQ10Pd/NhG3-M	GRS-CQ10Pd/NhG4-M
GRS-CQ12Pd/NhG3-E	GRS-CQ12Pd/NhG4-E
GRS-CQ14Pd/NhG3-E	GRS-CQ14Pd/NhG4-E
GRS-CQ16Pd/NhG3-E	GRS-CQ16Pd/NhG4-E
GRS-CQ12Pd/NhG3-M	GRS-CQ12Pd/NhG4-M
GRS-CQ14Pd/NhG3-M	GRS-CQ14Pd/NhG4-M
GRS-CQ16Pd/NhG3-M	GRS-CQ16Pd/NhG4-M

Thank you for choosing commercial air conditioners. Please read this Owner's Manual carefully before operation and retain it for future reference.

If you have lost the Owner's Manual, please contact the local agent or visit www.gree.com or send an email to global@cn.gree.com for the electronic version.

GREE ELECTRIC APPLIANCES, INC. OF ZHUHAI

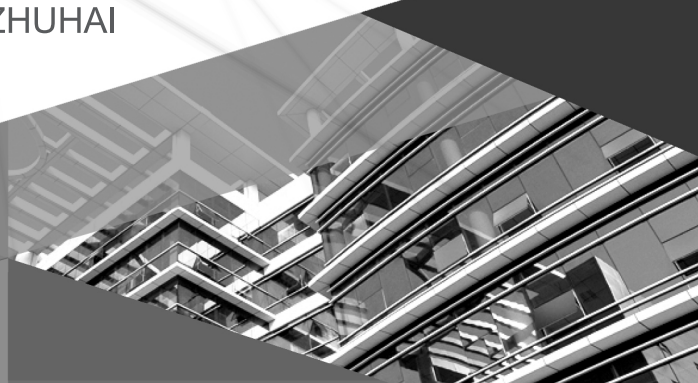

To Users

Thank you for selecting Gree's product. Please read this instruction manual carefully before installing and using the product, so as to master and correctly use the product. In order to guide you to correctly install and use our product and achieve expected operating effect, we hereby instruct as below:

- (1) This equipment should be installed, operated or maintained by the qualified servicemen who have had specific training. During operation, all safety issues covered in the labels, User's Manual and other literature should be followed strictly. This equipment is not intended for use by persons (including children) with reduced physical, sensory or mental capabilities, or lack of experience and knowledge, unless they have been given supervision or instruction concerning use of the appliance by a person responsible for their safety. Children should be supervised to ensure that they do not play with the appliance.
- (2) This product has gone through strict inspection and operational test before leaving the factory. In order to avoid damage due to improper disassembly and inspection, which may impact the normal operation of unit, please do not disassemble the unit by yourself. You can contact our designated dealer or local service center for professional support if necessary.
- (3) When the product is faulted and cannot be operated, please contact our designated dealer or local service center as soon as possible by providing the following information.
 - Contents of nameplate of product (model, cooling/heating capacity, product No., ex-factory date).
 - Malfunction status (specify the situations before and after the error occurs).
- (4) All the illustrations and information in the instruction manual are only for reference. In order to make the product better, we will continuously conduct improvement and innovation without further notice.

Contents

Safety Notices (Please be sure to abide)	1
1. Diagram of the Operating Principle	10
2. Operating Principle of the Unit	11
3. Nomenclature	12
4. Installation Example	14
5. Main Components	16
6. Installation Guideline of Monobloc Unit	16
6.1 Instruction to installation	16
6.2 Installation of monobloc unit	17
7. Installation of Hydraulic Unit	20
7.1 Available external static pressure of outlet.....	20
7.2 Ambient temperature and leaving water temperature upper limit	21
7.3 Water volume and expansion vessel pressure	22
7.4 The method of calculating the charging pressure of expansion vessel	22
7.5 Selection of expansion vessel.....	23
8. Remote Air Temperature Sensor	24
9. Thermostat	25
10. 2-Way Valve	26
11. 3-Way Valve	26
12. Other Thermal	27
13. Optional Electric Heater	28
14. Gate-controller	29
15. Charging and Discharging of Refrigerant	29
16. Installation of Insulated Water Tank	31
16.1 Installation measure.....	31
16.2 Outline dimension and parameter of water tank	32
16.3 Connection of waterway system	33
16.4 Requirements on water quality	35
16.5 Electric wiring work	35
17. Wiring Diagram	37
17.1 Control board	37
17.2 Electric wiring.....	43
18. Commissioning	48
18.1 Check before startup.....	48

18.2 Test run	49
19. Daily Operation and Maintenance	50
19.1 Recovery.....	51
19.2 Decommissioning.....	51
19.3 Notice before seasonal use	52
19.4 Safety considerations.....	52
19.5 Maintenance of the water tank.....	53
19.6 Maintenance of the unit.....	54

Safety Notices (Please be sure to abide)

 **WARNING:** If not abide strictly, it may cause severe damage to the unit or the people.

 **NOTE:** If not abide strictly, it may cause slight or medium damage to the unit or the people.

 This sign indicates that the operation must be prohibited. Improper operation may cause severe damage or death to people

 This sign indicates that the items must be observed. Improper operation may cause damage to people or property.

 **NOTE**

After receipt of the unit, check it for appearance, unit model compared with your desire and attachments.

Design and installation work of the unit must be performed by authorized personnel according to applicable laws and regulations and this Instruction.

After installation work, the unit cannot be energized unless there is not any problem in check.

Ensure periodical clean and maintenance of the unit after normal operation of the unit for longer life and reliable operation.

If the supply cord is damaged, it must be replaced by the manufacturer, its service agent or similarly qualified persons in order to avoid a hazard.

The appliance shall be installed in accordance with national wiring regulations.







This product is a kind of comfort air conditioning, and is not allowed to be installed where there are corrosive, explosive and inflammable substances or smog; otherwise it would lead to operation failure, shortened service life, five hazard or even severe injuries. Special air conditions are required for where mentioned above.



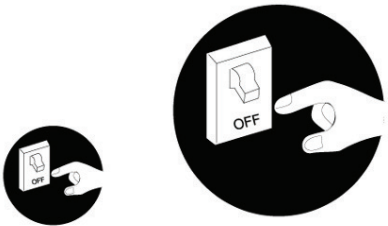

Correct Disposure

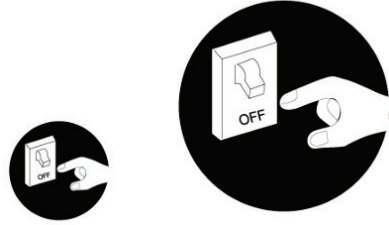



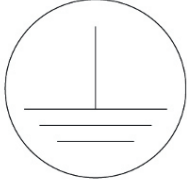
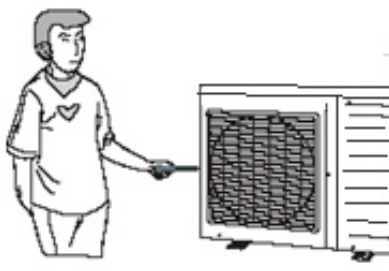

This marking indicates that this product should not be disposed with other household wastes throughout the EU. To prevent possible harm to the environment or human health from uncontrolled waste disposal, recycle it responsibly to promote the sustainable reuse of material resources. To return your used device, please use the return and collection systems or contact the retailer where the product was purchased. They can take this product for environmental safe recycling.

R32:675

⚠ WARNING		
<p>Once abnormality like burning smell occurs, please cut off the power supply immediately and then contact with service center.</p>  <p>If the abnormality still exists, the unit may be damaged and electric shock or fire may result.</p>	<p>Don't operate the unit with wet hand.</p>  <p>Otherwise, it may cause electric shock.</p>	<p>Before installation, please see if the voltage of local place accords with that on nameplate of unit and capacity of power supply, power cord or socket is suitable for input power of this unit.</p> 
<p>Special circuit must be adopted for power supply to prevent fire.</p>  <p>Do not use octopus multipurpose plug or mobile terminal board for wire connection.</p>	<p>Be sure to pull out the power plug and drain the indoor unit and water tank when unit is not in use for a long time.</p>  <p>Otherwise, the accumulated dust may cause overheating, fire or freeze of water tank or coaxial heater exchanger in winter.</p>	<p>Never damage the electric wire or use the one which is not specified.</p>  <p>Otherwise, it may cause overheating or fire.</p>

<p>Before cleaning please cut off the power supply.</p>   <p>Otherwise, it may cause electric shock or damage.</p>	<p>The power supply must adopt special circuit with leakage switch and enough capacity.</p>	<p>User can not change power cord socket without prior consent. Wiring working must be done by professionals. Ensure good earthing and don't change earthing mode of unit.</p>
<p>Earthing: the unit must be earthed reliably ! The earthing wire should connect with special device of buildings.</p>   <p>If not, please ask the qualified personnel to install. Furthermore, don't connect earth wire to gas pipe, water pipe, drainage pipe or any other improper places which professional does not recognize.</p>	<p>Never insert any foreign matter into outdoor unit to avoid damage . And never insert your hands into the air outlet of outdoor unit.</p> 	<p>Don't attempt to repair the unit by yourself.</p>  <p>Improper repair may cause electric shock or fire, so you should contact the service center to repair.</p>

<p>Don't step on the top of the unit or place anything on it.</p>  <p>There is the danger of fall of things or people.</p>	<p>Never block the air inlet and outlet of unit.</p>  <p>It may reduce efficiency or cause stop of the unit and even fire.</p>	<p>Keep pressurized spray, gas holder and so on away from the unit above 1m .</p>  <p>It may cause fire or explosion.</p>
<p>Please note whether the installation stand is firm enough or not.</p>  <p>If damaged, it may cause fall of the unit and injury of people.</p>	<p>Unit should be installed at the place with good ventilation to save energy.</p>	<p>When there is not water in water tank, never power the unit on to run.</p>

⚠ WARNING

Do not use means to accelerate the defrosting process or to clean, other than those recommended by the manufacturer. Should repair be necessary, contact your nearest authorized service centre. Any repairs carried out by unqualified personnel may be dangerous. The appliance shall be stored in a room without continuous operating ignition sources. (for example: open flames, an operating gas appliance or an operating electric heater.) Do not pierce or burn.

Appliance shall be installed, operated and stored in a room with a floor area larger than Xm .(Please refer to table “a” in section of “Safety Operation of Inflammable Refrigerant” for space X.)

Appliance filled with flammable gas R32. For repairs, strictly follow manufacturer’s instructions only. Be aware that refrigerants not contain odour. Read specialist’s manual.



If a stationary appliance is not fitted with a supply cord and a plug, or with other means for disconnection from the supply mains having a contact separation in all poles that provides full disconnection under overvoltage category III conditions, the instructions shall state that means for disconnection must be incorporated in the fixed wiring in accordance with the wiring rules.

This appliance can be used by children aged from 8 years and above and persons with reduced physical, sensory or mental capabilities or lack of experience and knowledge if they have been given supervision or instruction concerning use of the appliance in a safe way and understand the hazards involved. Children shall not play with the appliance. Cleaning and user maintenance shall not be made by children without supervision.

The appliance shall be stored in a well-ventilated area where the room size corresponds to the room area as specified for operation.

The appliance shall be stored in a room without continuously operating open flames (for example an operating gas appliance) and ignition sources (for example an operating electric heater).

The appliance shall be stored so as to prevent mechanical damage from occurring.

 NOTE	
	Appliance filled with flammable gas R32.
	Before use the appliance, read the owner's manual first.
<p>To realize the function of the air conditioner unit, a special refrigerant circulates in the system. The used refrigerant is the fluoride R32, which is specially cleaned. The refrigerant is flammable and inodorous. Furthermore, it can lead to explosion under certain conditions. But the flammability of the refrigerant is very low. It can be ignited only by fire.</p> <p>Compared to common refrigerants, R32 is a nonpolluting refrigerant with no harm to the ozone layer. The influence upon the greenhouse effect is also lower. R32 has got very good thermodynamic features which lead to a really high energy efficiency. The units therefore need a less filling.</p> <p>Before installation, please check if the adopted power is accordance with that listed on nameplate, and check the safety of power.</p> <p>The unit shall contact with the supply mains by a full disconnection device under overvoltage category III .</p> <p>Before using, please check and confirm if wires and water pipes are connected correctly to avoid water leakage, electric shock or fire etc.</p> <p>Don't operate the unit with wet hand, and don't allow children to operate the unit.</p> <p>The On/off in the instruction is for the operation to on and off button of PCB for users; cut off power means to stop supplying power to the unit.</p> <p>Don't directly expose the unit under the corrosive ambient with water or dampness.</p> <p>Don't operate the unit without water in water tank .The air outlet/inlet of unit cannot be blocked by other objects.</p> <p>The water in unit and pipeline should be discharged if the unit is not in use, to prevent the water tank, pipe line and water pump from frost-cracking.</p> <p>Never press the button with sharp objects to protect manual controller. Never use other wires instead of special communication line of the unit to protect control elements. Never clean the manual controller with benzene, thinner or chemical cloth to avoid fading of surface and failure of elements. Clean the unit with the cloth soaked in neutral eradicator. Slightly clean the display screen and connecting parts to avoid fading.</p> <p>The power cord must be separated with the communication line.</p> <p>Any person who is involved with working on or breaking into a refrigerant circuit should hold a current valid certificate from an industry-accredited assessment authority, which authorises their competence to handle refrigerants safely in accordance with an industry recognised assessment specification.</p> <p>Servicing shall only be performed as recommended by the equipment manufacturer. Maintenance and repair requiring the assistance of other skilled personnel shall be carried out under the supervision of the person competent in the use of flammable refrigerants.</p>	

Maximum and minimum water operating temperatures

Item	Minimum water operating temperatures	Maximum water operating temperatures
Cooling	5°C	25°C
Heating	20°C	65°C
Water heating	40°C	80°C

Maximum and minimum water operating pressures

Item	Minimum water operating pressures	Maximum water operating pressures
Cooling	0.05MPa	0.25MPa
Heating		
Water heating		

maximum and minimum entering water pressures.

Item	Minimum entering water pressures	Maximum entering water pressures
Cooling	0.05MPa	0.25MPa
Heating		
Water heating		

The range of external static pressures at which the appliance was tested (add-on heat pumps, and appliances with supplementary heaters, only); If the supply cord is damaged, it must be replaced by the manufacturer, its service agent or similarly qualified persons in order to avoid a hazard.

The appliance is intended to be permanently connected to the water mains and not connected by a hose-set.

If there is any question, please contact with local dealer, authorized service center, agencies or our company directly.

 NOTE

If any hot work is to be conducted on the refrigeration equipment or any associated parts, appropriate fire extinguishing equipment shall be available to hand. Have a dry powder or CO₂ fire extinguisher adjacent to the charging area.

Where electrical components are being changed, they shall be fit for the purpose and to the correct specification. At all times the manufacturer's maintenance and service guidelines shall be followed. If in doubt consult the manufacturer's technical department for assistance.

The following checks shall be applied to installations using flammable refrigerants:

- the charge size is in accordance with the room size within which the refrigerant containing parts are installed;
- the ventilation machinery and outlets are operating adequately and are not obstructed;
- if an indirect refrigerating circuit is being used, the secondary circuit shall be checked for the presence of refrigerant;
- marking to the equipment continues to be visible and legible. Markings and signs that are illegible shall be corrected;
- refrigeration pipe or components are installed in a position where they are unlikely to be exposed to any substance which may corrode refrigerant containing components, unless the components are constructed of materials which are inherently resistant to being corroded or are suitably protected against being so corroded.

Repair and maintenance to electrical components shall include initial safety checks and component inspection procedures. If a fault exists that could compromise safety, then no electrical supply shall be connected to the circuit until it is satisfactorily dealt with. If the fault cannot be corrected immediately but it is necessary to continue operation, an adequate temporary solution shall be used. This shall be reported to the owner of the equipment so all parties are advised.

Initial safety checks shall include: that capacitors are discharged: this shall be done in a safe manner to avoid possibility of sparking; that no live electrical components and wiring are exposed while charging, recovering or purging the system; that there is continuity of earth bonding.

During repairs to sealed components, all electrical supplies shall be disconnected from the equipment being worked upon prior to any removal of sealed covers, etc. If it is absolutely necessary to have an electrical supply to equipment during servicing, then a permanently operating form of leak detection shall be located at the most critical point to warn of a potentially hazardous situation.

Particular attention shall be paid to the following to ensure that by working on electrical components, the casing is not altered in such a way that the level of protection is affected. This shall include damage to cables, excessive number of connections, terminals not made to original specification, damage to seals, incorrect fitting of glands, etc.

Ensure that apparatus is mounted securely.

Ensure that seals or sealing materials have not degraded such that they no longer serve the purpose of preventing the ingress of flammable atmospheres. Replacement parts shall be in accordance with the manufacturer's specifications.

NOTE The use of silicon sealant may inhibit the effectiveness of some types of leak detection equipment.

Intrinsically safe components do not have to be isolated prior to working on them.

Do not apply any permanent inductive or capacitance loads to the circuit without ensuring that this will not exceed the permissible voltage and current permitted for the equipment in use.

Intrinsically safe components are the only types that can be worked on while live in the presence of a flammable atmosphere. The test apparatus shall be at the correct rating.

Replace components only with parts specified by the manufacturer. Other parts may result in the ignition of refrigerant in the atmosphere from a leak.

Check that cabling will not be subject to wear, corrosion, excessive pressure, vibration, sharp edges or any other adverse environmental effects. The check shall also take into account the effects of ageing or continual vibration from sources such as compressors or fans.

Under no circumstances shall potential sources of ignition be used in the searching for or detection of refrigerant leaks. A halide torch (or any other detector using a naked flame) shall not be used.

Equipment shall be labelled stating that it has been de-commissioned and emptied of refrigerant. The label shall be dated and signed. Ensure that there are labels on the equipment stating the equipment contains flammable refrigerant

1. Diagram of the Operating Principle

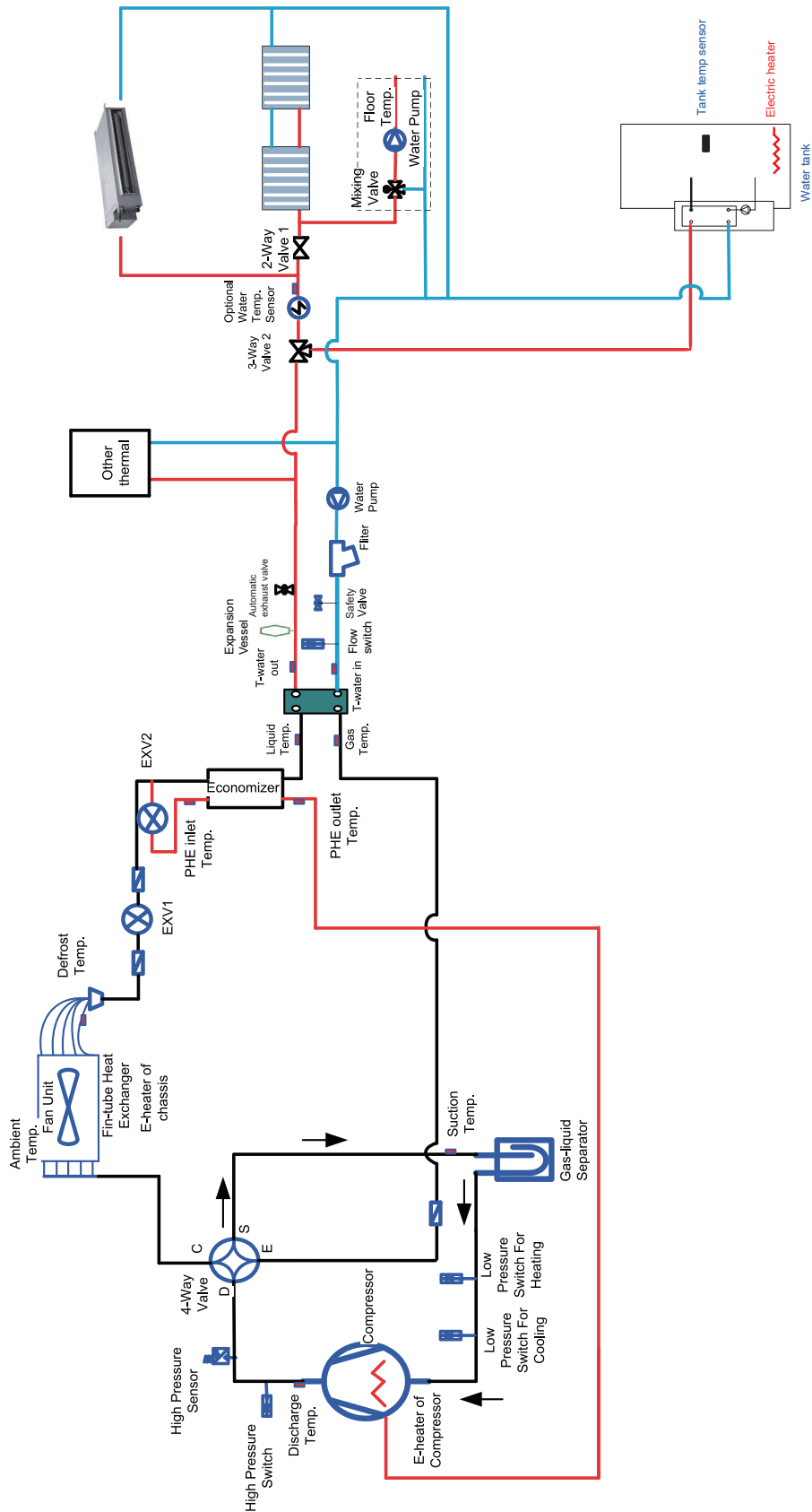

Note: the swimming pool, solar kit and water mixing accessory are optional parts. When they are required, please contact the manufacturer.

2. Operating Principle of the Unit

DC Inverter Air to Water Heat Pump is composed of outdoor unit, indoor unit and internal-fan coil water tank.

Operation functions:

- (1) Cooling;
- (2) Heating;
- (3) Water heating;
- (4) Cooling +water heating;
- (5) Heating+ water heating;
- (6) Emergency mode;
- (7) Fast hot water;
- (8) Holiday mode;
- (9) Forced operation mode;
- (10) Quiet mode;
- (11) Disinfection mode;
- (12) Weather-dependent operation;
- (13) Floor debugging;
- (14) Air removal of the water system;
- (15) Other thermal

Cooling: in cooling mode, the refrigerant is condensed in the outdoor unit and evaporated in the indoor unit. Via the heat exchange with water in the indoor unit, the temperature of water decreases and it releases heat while the refrigerant absorbs heat and evaporates. With the help of wired controller, the outflow temperature can meet the user's requirement. Through the control of valve, the low-temperature water in the system is connected with indoor fan coil and underground pipe, and exchanges heat with the indoor air so that the indoor temperature decreases to the required range.

Heating: in heating mode, the refrigerant evaporates in the outdoor unit and is condensed in the indoor unit. Via the heat exchange with water in the indoor unit, the water absorbs heat and its temperature increases while the refrigerant releases heat and is condensed. With the help of wired controller, the outflow temperature can meet the user's requirement. Through the control of valve, the high-temperature water in the system is connected with indoor fan coil and underground pipe, and exchanges heat with the indoor air so that the indoor temperature increases to the required range.

Water heating: in water heating mode: the refrigerant evaporates in the outdoor unit and is condensed in the indoor unit. Via the heat exchange with water in the indoor unit, the water absorbs heat and its temperature increase while the refrigerant releases heat and is condensed. With the help of wired controller, the outflow temperature can meet the user's requirement. Through the control of valve, the high-temperature water in the system is connected with the coil pipe of bearing water tank, and exchanges heat with the water in the water tank so that the temperature of water tank increases to the required range.

Cooling + water heating: when cooling mode exists together with the water heating mode, the user can set the priority of these two modes based on the needs. The default priority is heat pump. That is under the default setting, if cooling mode exists together with the water heating mode, the heat pump gives priority to cooling. In that case, water heating can only realized with e-heater of the water tank. Inversely, the heat pump gives priority to water heating and switches to cooling after finishing water heating.

Heating+ water heating: when heating mode exists together with the water heating mode, the user can set the priority of these two modes based on the needs. The default priority is heat pump. That is under the default setting, if heating mode exists together with the water heating mode, the heat pump gives priority to heating. In that case, water heating can only realized with e-heater of the water tank. Inversely, the heat pump gives priority to water heating and switches to heating after finishing water heating.

Emergency mode: this mode is only available for heating and water heating. When the outdoor unit stops due to malfunction, enter the corresponding emergency mode; as to heating mode, after entering the emergency mode, heating can only be realized through e-heater of the indoor unit. When the setting outflow temperature or indoor temperature is reached, the e-heater of indoor unit will stop running; as to water heating mode, the e-heater of indoor unit stops while the e-heater of water tank runs. When the setting temperature or water tank is reached, the e-heater will stop running.

Fast hot water: at the fast hot water mode, the unit runs according to the water heating control of heat pump and the e-heater of water tank runs at the same time.

Forced operation mode: this mode is only used for refrigerant recovery and debugging for the unit.

Holiday mode: this mode is only available for heating mode. This mode is set to keep indoor temperature or leaving water temperature in a certain range, so as to prevent water system of the unit from freezing or protect certain indoor articles from freezing damage. When the outdoor unit stops due to malfunction, the two e-heaters of the unit will run.

Disinfection mode: in this mode, the water heating system can be disinfected. When starting up the disinfection function and setting corresponding time to meet the requirement of disinfection mode, the function will start. After the setting temperature is reached, this mode will terminate.

Weather-dependent operation: this mode is only available for space heating or space cooling. In Weather-dependent mode, the setting value (remote room air temperature or leaving water temperature) is detected and controlled automatically when the outdoor air temperature is changed.

Quiet mode: Quiet mode is available in cooling, heating and water heating mode. At the quiet mode, the outdoor unit will reduce the running noise via automatic control.

Floor commissioning: this function is intended to preheat the floor periodically for the initial use.

Air removal of the water system: this function is intended to replenish water and remove air in the water system to make the equipment run at the stabilized water pressure.

Solar water heater: when the condition for starting the solar water heater is satisfied, the solar heater will start to heat the circulation water. Then the heated water will go to the water tank and exchange heat with water in it. At any condition, the solar water heater will be given priority for startup so as for energy conservation.

Other thermal: when the outdoor temperature is lower than the set point for starting other thermal and the unit is under the error condition and the compressor has stopped for three minutes, the other thermal will start to supply heat or hot water to the room.

3. Nomenclature

G	RS	-	C	Q	16	Pd	/	Nh	G	-	M
1	2		3	4	5	6		7	8		9

NO.	Description	Options
1	GREE	G-GREE Air to water heat pump
2	Heat Pump Water Heater	RS
3	Heating Mode	S= Static; C=Circulating
4	Function	Q=Multi-function; Omit=Single-function
5	Nominal Heating Capacity	4.0=4.0kW; 6.0=6.0kW; 8.0=8.0kW; 10=10kW; 12=12kW; 14=14kW; 16=16kW
6	Compressor Style	Pd=DC Inverter; Omit=On/Off
7	Refrigerant	Na=R410A; Nh=R32
8	Design Serial Number	G3,G4, G4 series is the same with G3 series but without the electric heater.
9	Power Supply	E=230V,~,50Hz;M=400V,3N~,50Hz

Model Line-Up

Model	Heating1, kW	Power Input, kW	COP, W/W	Power supply
GRS-CQ4.0Pd/NhG3-E	5.00	0.926	5.40	230VAC, 1Ph, 50Hz
GRS-CQ6.0Pd/NhG3-E	6.00	1.111	5.40	
GRS-CQ8.0Pd/NhG3-E	8.20	1.54	5.32	
GRS-CQ10Pd/NhG3-E	10.20	2.02	5.05	
GRS-CQ12Pd/NhG3-E	12.0	2.43	4.93	
GRS-CQ14Pd/NhG3-E	14.2	2.99	4.75	
GRS-CQ16Pd/NhG3-E	15.7	3.45	4.55	
GRS-CQ8.0Pd/NhG3-M	8.20	1.62	5.06	400VAC, 3Ph, 50Hz
GRS-CQ10Pd/NhG3-M	10.20	2.06	4.95	
GRS-CQ12Pd/NhG3-M	12.0	2.49	4.81	
GRS-CQ14Pd/NhG3-M	14.2	3.09	4.60	
GRS-CQ16Pd/NhG3-M	15.7	3.57	4.40	
GRS-CQ4.0Pd/NhG4-E	5.00	0.926	5.40	230VAC, 1Ph, 50Hz
GRS-CQ6.0Pd/NhG4-E	6.00	1.111	5.40	
GRS-CQ8.0Pd/NhG4-E	8.20	1.54	5.32	
GRS-CQ10Pd/NhG4-E	10.20	2.02	5.05	
GRS-CQ12Pd/NhG4-E	12.0	2.43	4.93	
GRS-CQ14Pd/NhG4-E	14.2	2.99	4.75	
GRS-CQ16Pd/NhG4-E	15.7	3.45	4.55	
GRS-CQ8.0Pd/NhG4-M	8.20	1.62	5.06	400VAC, 3Ph, 50Hz
GRS-CQ10Pd/NhG4-M	10.20	2.06	4.95	
GRS-CQ12Pd/NhG4-M	12.0	2.49	4.81	
GRS-CQ14Pd/NhG4-M	14.2	3.09	4.60	
GRS-CQ16Pd/NhG4-M	15.7	3.57	4.40	

Model	Cooling1 ,kW	Power Input, kW	EER, W/W	Power supply
GRS-CQ4.0Pd/NhG3-E	5.00	0.962	5.20	230VAC, 1Ph, 50Hz
GRS-CQ6.0Pd/NhG3-E	6.50	1.275	5.10	
GRS-CQ8.0Pd/NhG3-E	8.30	1.56	5.32	
GRS-CQ10Pd/NhG3-E	10.2	2.00	5.10	
GRS-CQ12Pd/NhG3-E	12.0	2.45	4.90	
GRS-CQ14Pd/NhG3-E	13.7	3.00	4.57	
GRS-CQ16Pd/NhG3-E	15.5	3.60	4.30	
GRS-CQ8.0Pd/NhG3-M	8.30	1.64	5.06	400VAC, 3Ph, 50Hz
GRS-CQ10Pd/NhG3-M	10.20	2.13	4.79	
GRS-CQ12Pd/NhG3-M	12.0	2.61	4.60	
GRS-CQ14Pd/NhG3-M	13.9	3.32	4.19	
GRS-CQ16Pd/NhG3-M	15.4	4.05	3.80	
GRS-CQ4.0Pd/NhG4-E	5.00	0.962	5.20	230VAC, 1Ph, 50Hz
GRS-CQ6.0Pd/NhG4-E	6.50	1.275	5.10	
GRS-CQ8.0Pd/NhG4-E	8.30	1.56	5.32	
GRS-CQ10Pd/NhG4-E	10.2	2.00	5.10	
GRS-CQ12Pd/NhG4-E	12.0	2.45	4.90	
GRS-CQ14Pd/NhG4-E	13.7	3.00	4.57	
GRS-CQ16Pd/NhG4-E	15.5	3.60	4.30	

Model	Cooling ¹ , kW	Power Input, kW	EER, W/W	Power supply
GRS-CQ8.0Pd/NhG4-M	8.30	1.64	5.06	400VAC, 3Ph, 50Hz
GRS-CQ10Pd/NhG4-M	10.20	2.13	4.79	
GRS-CQ12Pd/NhG4-M	12.0	2.61	4.60	
GRS-CQ14Pd/NhG4-M	13.9	3.32	4.19	
GRS-CQ16Pd/NhG4-M	15.4	4.05	3.80	

Notes

- (a) ¹Capacities and power inputs are based on the following conditions:
Indoor Water Temperature 30°C/35°C, Outdoor Air Temperature 7°C DB/6°C WB;
- (b) ²Capacities and power inputs are based on the following conditions:
Indoor Water Temperature 23°C/18°C, Outdoor Air Temperature 35°C DB/24°C WB.

Mode	Heat Source Side Temperature (°C)	User Side Temperature (°C)
Heating	-25~35	20~65
Cooling	-15~48	5~25
Water Heating	-25~45	40~80

4. Installation Example

CASE 1: Connecting Under-floor Coil for Heating and Cooling

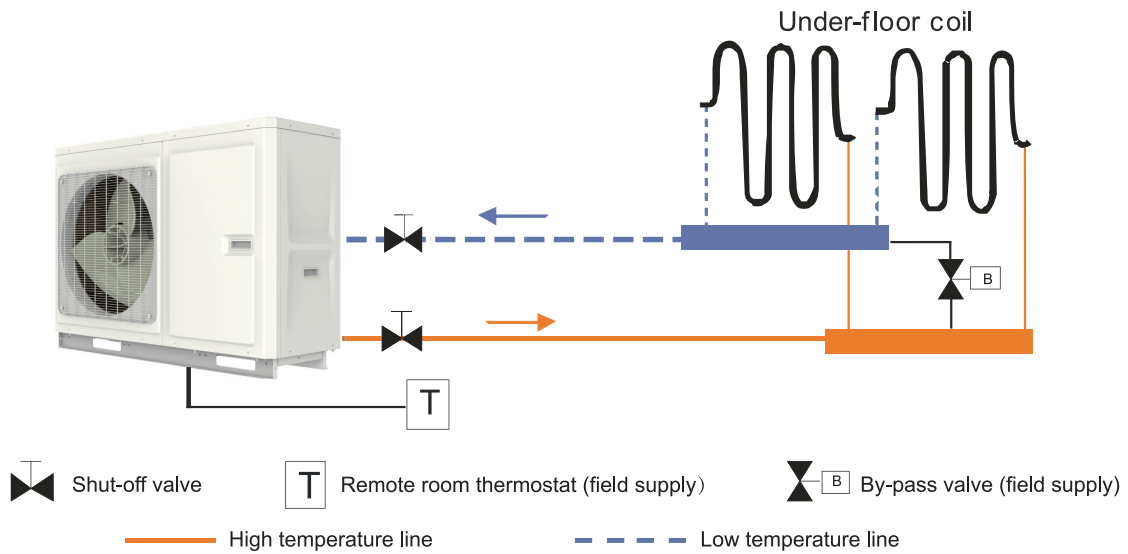

Notes

- (a) Type of thermostat and specification should be complied with installation of this manual;
- (b) By pass valve must be installed to secure enough water flow rate, and by pass valve should be installed at the collector.

CASE 2: Connecting Sanitary Water Tank and Under-floor Coil

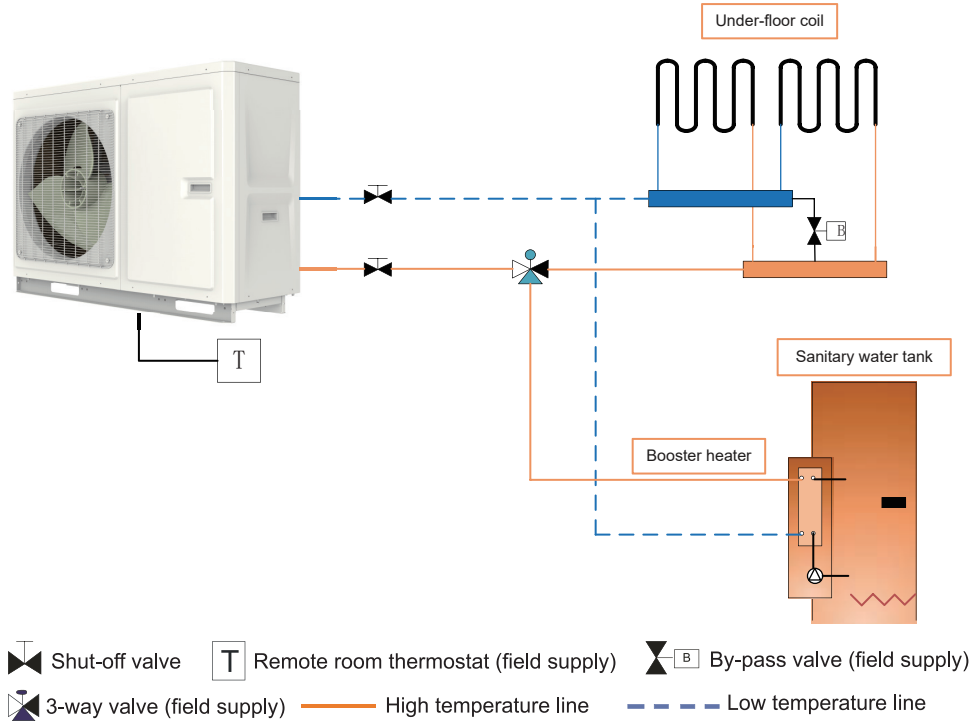

Notes

- (a) In this case, three-way valve should be installed and should be complied with installation of this manual;
- (b) Sanitary should be equipped with internal electric heater to secure enough heat energy in the very cold days.

CASE 3 : Connecting Sanitary Water Tank, Under-floor Coil and FCU

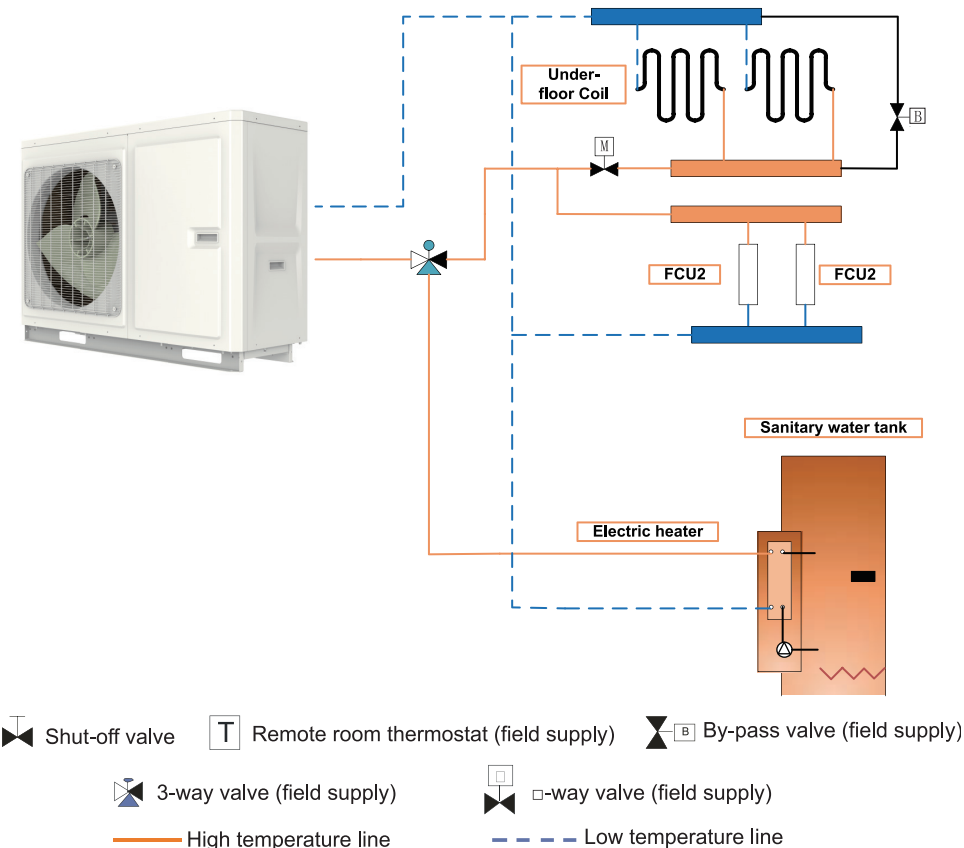

Note

Two-way valve is very important to prevent dew condensation on the floor and Radiator while cooling mode.

5. Main Components

(1) For models below

GRS-CQ4.0Pd/NhG3-E
 GRS-CQ8.0Pd/NhG3-E
 GRS-CQ16Pd/NhG3-E,
 GRS-CQ14Pd/NhG3-M
 GRS-CQ12Pd/NhG4-E
 GRS-CQ10Pd/NhG4-M

GRS-CQ6.0Pd/NhG3-E
 GRS-CQ10Pd/NhG3-E
 GRS-CQ8.0Pd/NhG3-M
 GRS-CQ16Pd/NhG3-M
 GRS-CQ14Pd/NhG4-E
 GRS-CQ12Pd/NhG4-M

GRS-CQ4.0Pd/NhG4-E
 GRS-CQ12Pd/NhG3-E
 GRS-CQ10Pd/NhG3-M
 GRS-CQ8.0Pd/NhG4-E
 GRS-CQ16Pd/NhG4-E
 GRS-CQ14Pd/NhG4-M

GRS-CQ6.0Pd/NhG4-E
 GRS-CQ14Pd/NhG3-E
 GRS-CQ12Pd/NhG3-M
 GRS-CQ10Pd/NhG4-E
 GRS-CQ8.0Pd/NhG4-M
 GRS-CQ16Pd/NhG4-M

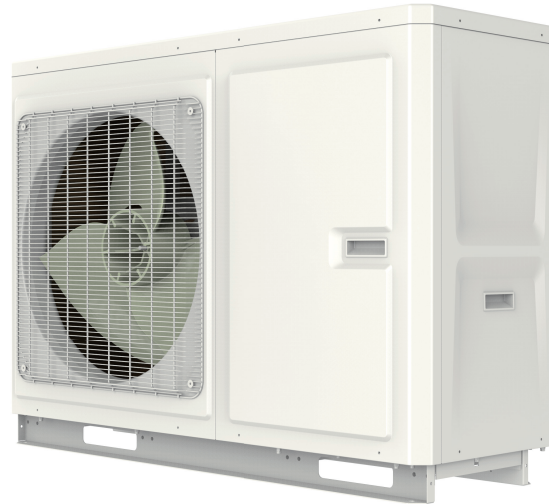

6. Installation Guideline of Monobloc Unit

6.1 Instruction to installation

- (1) Installation of the unit must be in accordance with national and local safety codes.
- (2) Installation quality will directly affect the normal use of the air conditioner unit. The user is prohibited from installation. Please contact your dealer after buying this machine. Professional installation workers will provide installation and test services according to installation manual.
- (3) Do not connect to power until all installation work is completed.

6.2 Installation of monobloc unit

6.2.1 Selection of installation location of monobloc unit

- (1) Monobloc unit must be installed on a firm and solid support.
- (2) Avoid placing the monobloc unit under window or between two constructions, hence to prevent normal operating noise from entering the room.
- (3) Air flow at inlet and outlet shall not be blocked.
- (4) Install at a well-ventilated place, so that the machine can absorb and discharge sufficient air.
- (5) Do not install at a place where flammable or explosive goods exist or a place subject to severe dust, salty fog and polluted air.

6.2.2 Outline dimension of monobloc unit

(1) For models below

GRS-CQ4.0Pd/NhG3-E

GRS-CQ6.0Pd/NhG3-E

GRS-CQ4.0Pd/NhG4-E

GRS-CQ6.0Pd/NhG4-E

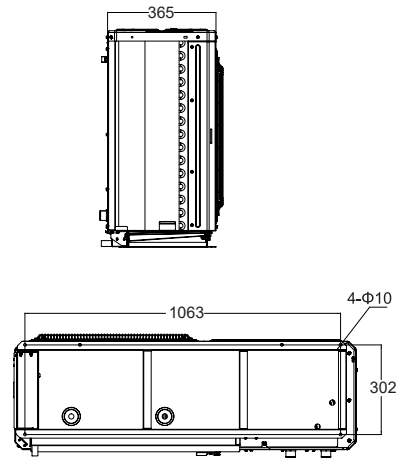
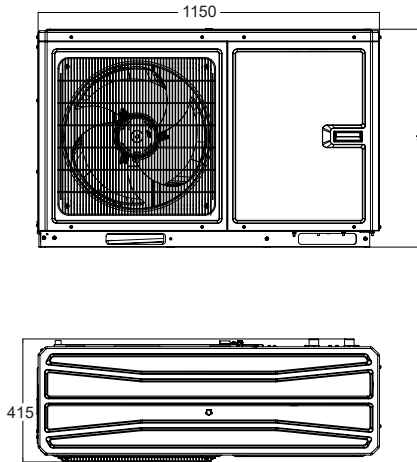

(2) For models below

GRS-CQ8.0Pd/NhG3-E,

GRS-CQ10Pd/NhG3-E

GRS-CQ12Pd/NhG3-E

GRS-CQ14Pd/NhG3-E

GRS-CQ16Pd/NhG3-E

GRS-CQ8.0Pd/NhG3-M

GRS-CQ10Pd/NhG3-M

GRS-CQ12Pd/NhG3-M

GRS-CQ14Pd/NhG3-M

GRS-CQ16Pd/NhG3-M

GRS-CQ8.0Pd/NhG4-E

GRS-CQ10Pd/NhG4-E

GRS-CQ12Pd/NhG4-E

GRS-CQ14Pd/NhG4-E

GRS-CQ16Pd/NhG4-E

GRS-CQ8.0Pd/NhG4-M

GRS-CQ10Pd/NhG4-M

GRS-CQ12Pd/NhG4-M

GRS-CQ14Pd/NhG4-M

GRS-CQ16Pd/NhG4-M

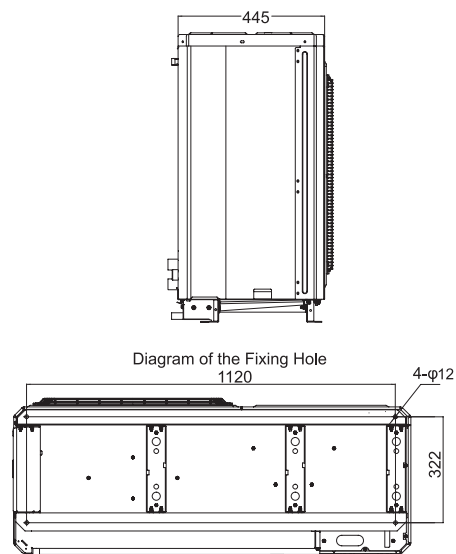
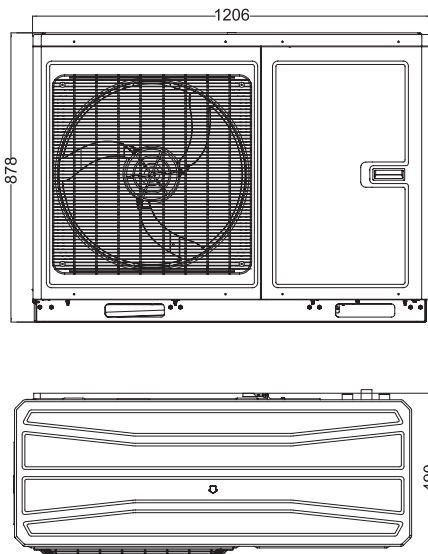

Description:

Unit: inch

No.	Name	Remarks
1	Handle	Used to cover or uncover the front case
2	Air discharge Grill	/

6.2.3 Space requirements for installation

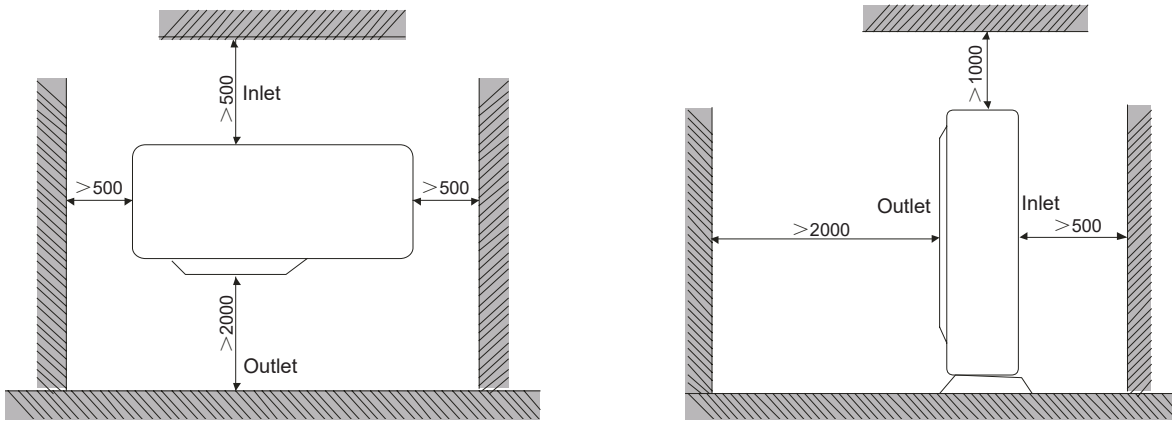

Note: In consideration of space restriction, for the left-handed figure, except the outlet side, distance between the unit and the nearest barrier at other three sides are allowed to be no less than 300mm; for the right-handed figure, distance between the inlet side and the nearest barrier is allowed to be no less than 300mm.

6.2.4 Precautions on installation of monobloc unit

- (1) When moving outdoor unit, it is necessary to adopt 2 pieces of long enough rope to hand the unit from 4 directions. Included angle between the rope when hanging and moving must be 40° below to prevent center of the unit from moving.
- (2) Adopt M12 bolts components to tighten feet and under frame when installing.
- (3) Monobloc unit should be installed on concrete base that is 10cm height.
- (4) Requirements on installation space dimension of unit's bodies are shown in following drawing.
- (5) Monobloc unit must be lifted by using designated lifting hole. Take care to protect the unit during lift. To avoid rusting, do not knock the metal parts.

6.2.5 Usage of rubber rings



- (1) Take away the original rubber rings, replace the long tail rubber rings of accessory;
- (2) Wires installed by field supply get through the rubber rings, such as 2-way valve, 3-way valve, power cable and so on. Be careful of separating electrical wire and light current wire.
- (3) Tie the rubber rings after finishing wire connection.

6.2.6 Safety operation of flammable refrigerant

(1) Qualification requirement for installation and maintenance

All the work men who are engaging in the refrigeration system should bear the valid certification awarded by the authoritative organization and the qualification for dealing with the refrigeration system recognized by this industry. If it needs other technician to maintain and repair the appliance, they should be supervised by the person who bears the qualification for using the flammable refrigerant.

It can only be repaired by the method suggested by the equipment's manufacturer.

(2) Installation notes

The unit is not allowed to use in a room that has running fire (such as firesource, working coal gas ware, operating heater).

It is not allowed to drill hole or burn the connection pipe.

The unit must be installed in a room that is larger than the minimum room area. The minimum room area is shown on the nameplate or following table.

A leak test is a must after installation.

Minimum room area (m ²)	Charge amount(kg)	≤1.2	1.3	1.4	1.5	1.6	1.7	1.8	1.9	2	2.1	2.2	2.3	2.4	2.5
	floor location	/	14.5	16.8	19.3	22	24.8	27.8	31	34.3	37.8	41.5	45.4	49.4	53.6
window mounted	/	5.2	6.1	7	7.9	8.9	10	11.2	12.4	13.6	15	16.3	17.8	19.3	
wall mounted	/	1.6	1.9	2.1	2.4	2.8	3.1	3.4	3.8	4.2	4.6	5	5.5	6	
ceiling mounted	/	1.1	1.3	1.4	1.6	1.8	2.1	2.3	2.6	2.8	3.1	3.4	3.7	4	

(3) Maintenance notes

Check whether the maintenance area or the room area meet the requirement.

- It's only allowed to be operated in the rooms that meet the requirement.

Check whether the maintenance area is well-ventilated.

- The continuous ventilation status should be kept during the operation process.

Check whether there is fire source or potential fire source in the maintenance area.

- The naked flame is prohibited in the maintenance area; and the "no smoking" warning board should be hanged. nameplate.

Check whether the appliance mark is in good condition.

- Replace the vague or damaged warning mark.

(4) Welding

If you should cut or weld the refrigerant system pipes in the process of maintaining, please follow the steps as below:

a. Shut down the unit and cut power supply

b. Eliminate the refrigerant

c. Vacuuming

d. Clean it with N₂ gas

e. Cutting or welding

f. Carry back to the service spot for welding

The refrigerant should be recycled into the specialized storage tank.

Make sure that there isn't any naked flame near the outlet of the vacuum pump and it's well-ventilated.

(5) Filling the refrigerant

Use the refrigerant filling appliances specialized for R32. Make sure that different kinds of refrigerant won't contaminate with each other.

The refrigerant tank should be kept upright at the time of filling refrigerant.

Stick the label on the system after filling is finished (or haven't finished).

Don't overfilling.

After filling is finished, please do the leakage detection before test running; another time of leak detection should be done when it's removed.

(6) Safety instructions for transportation and storage

Please use the flammable gas detector to check before unload and open the container.

No fire source and smoking.

Do comply with the local rules and laws.

7. Installation of Hydraulic Unit

7.1 Available external static pressure of outlet

(1) GRS-CQ4.0Pd/NhG3-E, GRS-CQ6.0Pd/NhG3-E, GRS-CQ4.0Pd/NhG4-E, GRS-CQ6.0Pd/NhG4-E

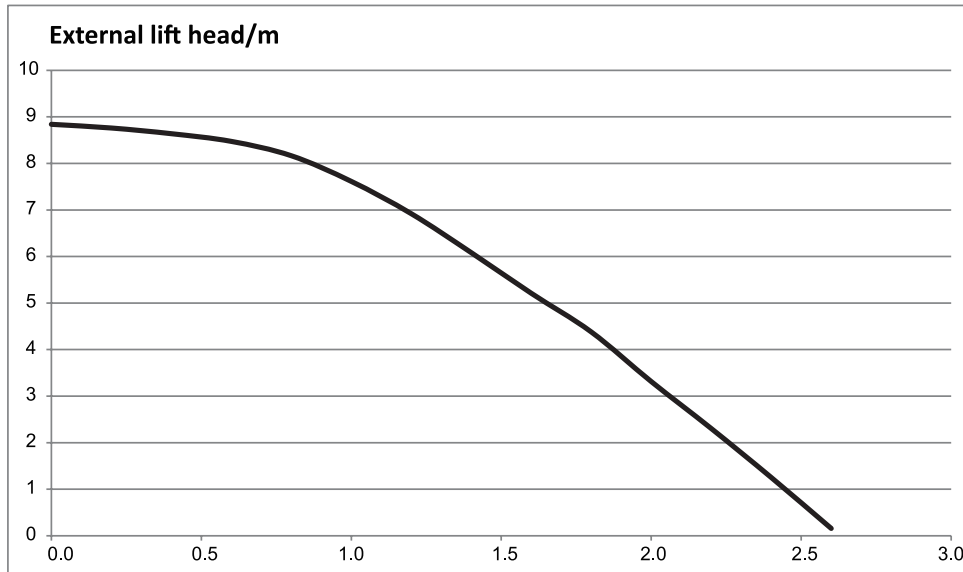

(2) GRS-CQ8.0Pd/NhG3-E, GRS-CQ10Pd/NhG3-E, GRS-CQ8.0Pd/NhG3-M, GRS-CQ10Pd/NhG3-M, GRS-CQ8.0Pd/NhG4-E, GRS-CQ10Pd/NhG4-E, GRS-CQ8.0Pd/NhG4-M, GRS-CQ10Pd/NhG4-M

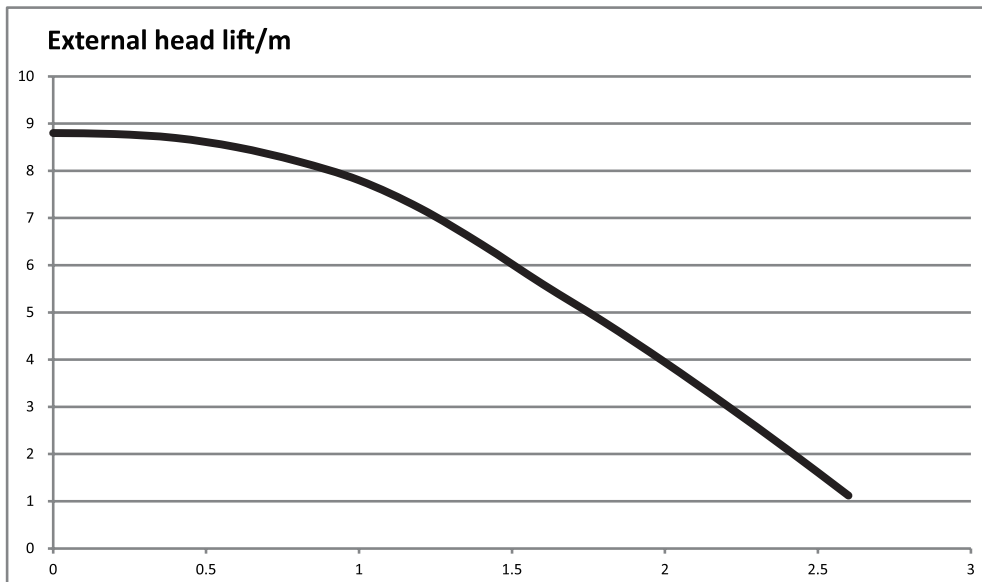

Notes

(a) See the curve above for the maximum external static pressure. The water pump is of variable frequency. And during operation, the water pump will adjust its output based on the actual load.

(3) GRS-CQ12Pd/NhG3-E, GRS-CQ14Pd/NhG3-E, GRS-CQ16Pd/NhG3-E, GRS-CQ12Pd/NhG3-M, GRS-CQ14Pd/NhG4-M, GRS-CQ16Pd/NhG4-M, GRS-CQ12Pd/NhG4-E, GRS-CQ14Pd/NhG4-E, GRS-CQ16Pd/NhG4-E, GRS-CQ12Pd/NhG4-M, GRS-CQ14Pd/NhG4-M, GRS-CQ16Pd/NhG4-M

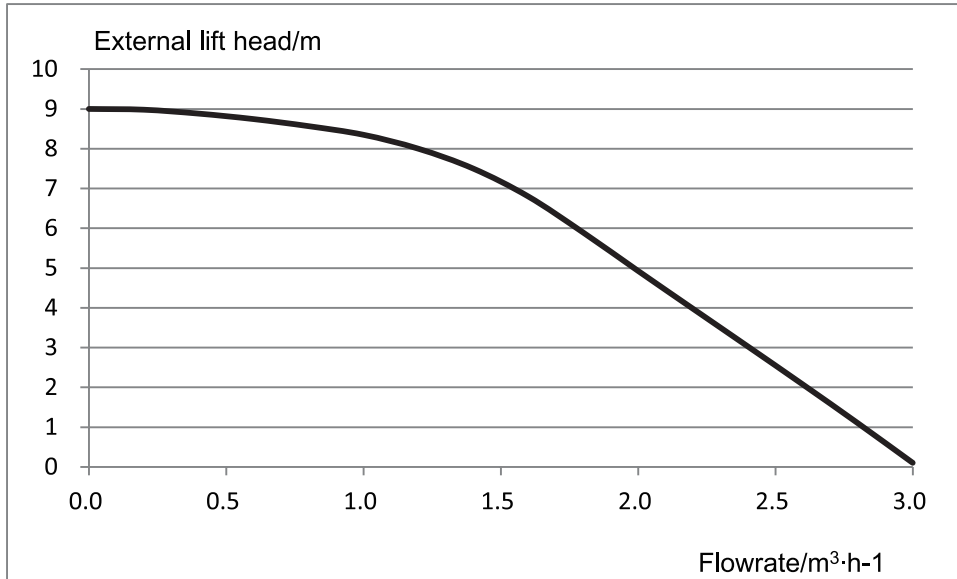

Notes

(a) See the curve above for the maximum external static pressure. The water pump is of variable frequency. And during operation, the water pump will adjust its output based on the actual load.

7.2 Ambient temperature and leaving water temperature upper limit

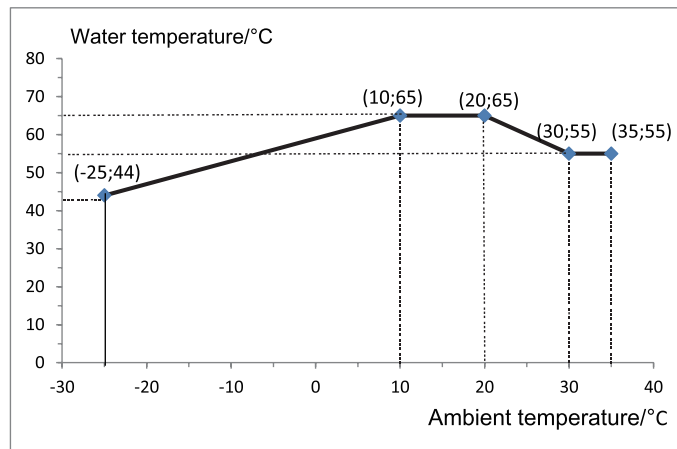

Note: the ambient temperature and water temperature should be subject to the actual operation of the unit.

7.3 Water volume and expansion vessel pressure

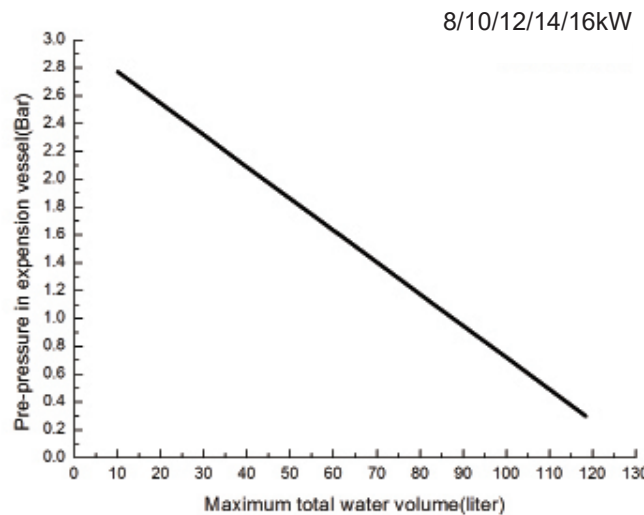
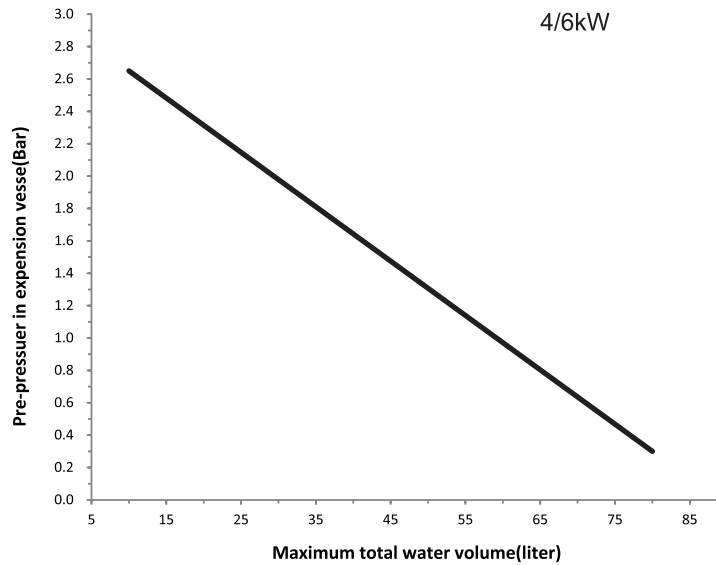

Notes

- (a) The expansion vessel is 2 liters and 1.5bar pre-pressurized for 4/6kW units; 3 liters and 1.5bar pre-pressurized for 8/10/12/14/16kW units;
- (b) Total water volume of 44 liters is default for 4/6kW units and 66 liters for 8/10/12/14/16kW unit; if total water is changed because of installation condition, the pre-pressure should be adjusted to secure proper operation. If the unit is located at the highest position, adjustment is not required;
- (c) Minimum total water volume is 20 liters;
- (d) To adjust pre-pressure, use nitrogen gas by certificated installer.

7.4 The method of calculating the charging pressure of expansion vessel

The method of calculating the charging pressure of expansion vessel needed to be adjusted is as follows.

During installation, if the volume of water system has changed, please check if the pre-set pressure of the expansion vessel needs to be adjusted according to the following formula:

$$P_g = (H / 10 + 0.3) \text{ Bar}$$

(H ---the difference between installing location of indoor unit and the highest spot of water system)

Ensure that the volume of water system is lower than the maximum volume required in the above figure. If it exceeds the range, the expansion vessel does not meet the installing requirement.

For 4/6units

Installation height 1 difference	Water volume	
	<44L	>44L
< 12m	Adjustment is not necessary	1. Pre-set pressure needs to be adjusted according to the above formula. 2. Check if the water volume is lower than the maximum water volume. (with help of the above figure)
> 12m	1. Pre-set pressure needs to be adjusted according to the above formula. 2. Check if the water volume is lower than the maximum water volume. (with help of the above figure)	The expansion vessel is too small and adjustment is not available.

For 8/10/12/14/16 units

Installation height 1 difference	Water volume	
	<66L	>66L
<12 m	Adjustment is not necessary	1. Pre-set pressure needs to be adjusted according to the above formula. 2. Check if the water volume is lower than the maximum water volume. (with help of the above figure)
> 12 m	1. Pre-set pressure needs to be adjusted according to the above formula. 2. Check if the water volume is lower than the maximum water volume. (with help of the above figure)	The expansion vessel is too small and adjustment is not available.

Note

(a) Installation height difference: the difference between installing location of indoor unit and the highest spot of water system; if the indoor unit is located at the highest point of the installation, the installation height difference is considered 0m.

(b) Example 1: The 16kW unit is installed 5m below the highest spot of water system and the total volume of the water system is 60L.

(c) Referring to the above figure, it is not necessary to adjust the pressure of the expansion vessel.

(d) Example 2: The unit is installed on the highest spot of the water system and the total water volume is 100L.

(e) As the volume of water system is higher than 66L, it is necessary to adjust the pressure of the expansion vessel be lower.

(f) The formula of calculating pressure

$$P_g = (H/10 + 0.3) = (0/10 + 0.3) = 0.3 \text{ Bar}$$

(g) The maximum volume of the water system is about 118L. As the actual volume of the water system is 100L, the expansion vessel meets the installing requirement.

(h) Adjust the pre-set pressure of the expansion vessel from 1.5Bar to 0.3Bar.

7.5 Selection of expansion vessel

Formula:

$$V = \frac{C \cdot e}{1 - \frac{1 + p_1}{1 + p_2}}$$

V--- Volume of expansion vessel

C--- Total water volume

P₁--- Pre-set pressure of expansion vessel

P₂-- The highest pressure during running of the system (that is the action pressure of safety valve.)

e---The expansion factor of water (the difference between the expansion factor of the original water temperature and that of highest water temperature.)

Water expansion factor in different temperature	
Temperature (°C)	Expansion factor e
0	0.00013
4	0
10	0.00027
20	0.00177
30	0.00435
40	0.00782
45	0.0099
50	0.0121
55	0.0145
60	0.0171
65	0.0198
70	0.0227
75	0.0258
80	0.029
85	0.0324
90	0.0359
95	0.0396
100	0.0434

8. Remote Air Temperature Sensor



Front side



Back side

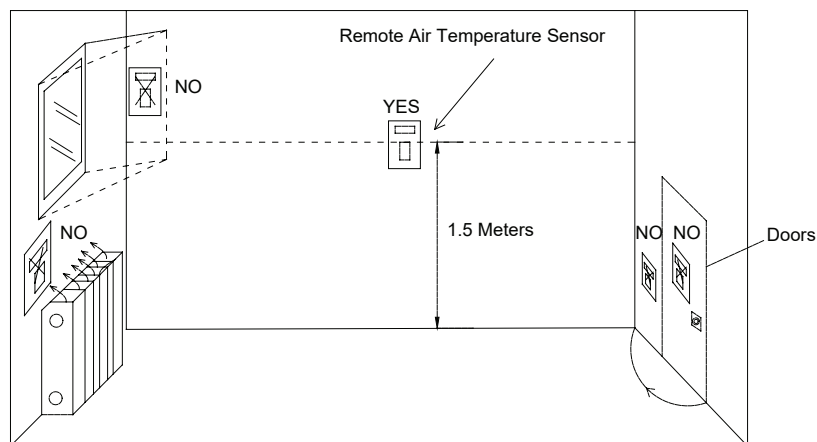

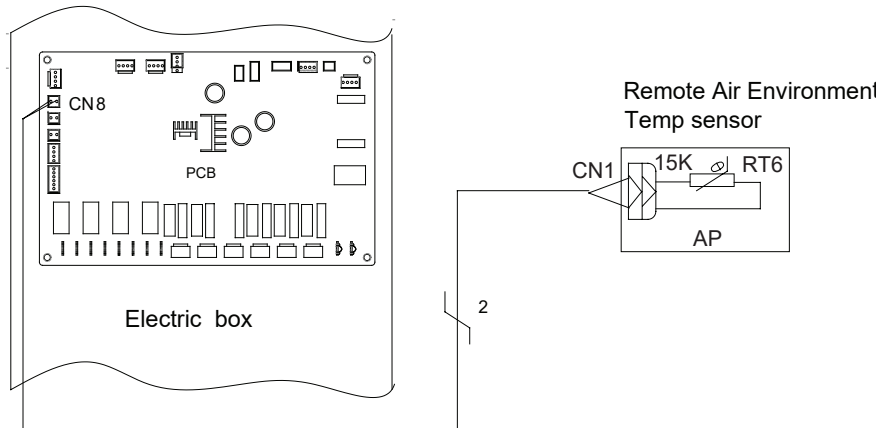

Notes

- (a) Distance between the indoor unit and the remote air temperature sensor should be less than 15m due to length of the connection cable of remote air temperature sensor;
- (b) Height from floor is approximately 1.5m;
- (c) Remote air temperature sensor cannot be located where the area may be hidden when door is open;
- (d) Remote air temperature sensor cannot be located where external thermal influence may be applied;
- (e) Remote air temperature sensor should be installed where space heating is mainly applied;
- (f) After the remote air temperature sensor is installed, it should be set to “With” through the wired controller so as to set the remote air temperature to the control point.

9. Thermostat

Installation of the thermostat is very similar to that of the remote air temperature sensor.

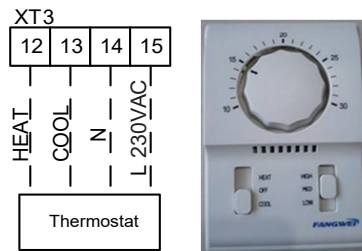

How to Wire Thermostat

- (1) Uncover the front cover of indoor unit and open the control box;
- (2) Identify the power specification of the thermostat, if it is 220V, find terminal block XT3 as NO.12~15;
- (3) If it is the heating/cooling thermostat, please connect wire as per the figure above.

NOTE

- 220V power supply can be provided to the thermostat by the Versati III heat pump.
- Setting temperature by the thermostat(heating or cooling) should be within the temperature range of the product ;
- For other constrains, please refer to previous pages about the remote air temperature sensor;
- Do not connect external electric loads. Wire 220V AC should be used only for the electric thermostat;
- Never connect external electric loads such as valves, fan coil units, etc. If connected, the mainboard of the unit can be seriously damaged;
- Installation of the thermostat is very similar to that of the remote air temperature sensor.

10. 2-Way Valve

The role of 2-way valve 1 is to control the water flow into the underfloor loop. When “Floor Config” is set to “With” for either cooling or heating operation, it will keep open. When “Floor Config” is set to “ Without”, it will keep closed.

General Information

Type	Power	Operating Mode	Supported
NO 2-wire	230V 50Hz ~AC	Closing water flow	Yes
		Opening water flow	Yes
NC 2-wire	230V 50Hz ~AC	Closing water flow	Yes
		Opening water flow	Yes

- (1) Normal Open type. When electric power is NOT supplied, the valve is open. (When electric power is supplied, the valve is closed.)
- (2) Normal Closed type. When electric power is NOT supplied, the valve is closed. (When electric power is supplied, the valve is open.)
- (3) How to Wire 2-Way Valve:

Follow steps below to wire the 2-way valve.

Step 1. Uncover the front cover of the unit and open the control box.

Step 2. Find the terminal block and connect wires as below.

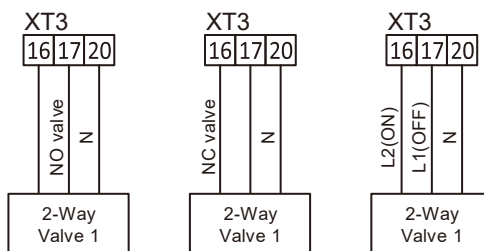

⚠ WARNING

- Normal Open type should be connected to wire (OFF) and wire (N) for valve closing in cooling mode.
- Normal Closed type should be connected to wire (ON) and wire (N) for valve closing in cooling mode.

(ON) : Line signal (for Normal Open type) from PCB to 2-way valve
 (OFF) : Line signal (for Normal Closed type) from PCB to 2-way valve
 (N) : Neutral signal from PCB to 2-way valve

11. 3-Way Valve

The 3-way valve 2 is required for the sanitary water tank. Its role is flow switching between the under floor heating loop and the water tank heating loop.

General Information

Type	Power	Operating Mode	Supported
SPDT 3-wire	230V 50Hz ~AC	Selecting “Flow A” between “Flow A” and “Flow B”	Yes
		Selecting “Flow B” between “Flow B” and “Flow A”	Yes

- (1) SPDT = Single Pole Double Throw. Three wires consist of Live1 (for selecting Flow B), and Neutral (for common).
- (2) Flow A means 'water flow from the indoor unit to under floor water circuit'.
- (3) Flow B means 'water flow from the indoor unit to sanitary water tank'.

Follow steps below to wire the 3-way valve:

Follow below procedures Step 1 ~ Step 2.

Step 1. Uncover front cover of the unit and open the control box.

Step 2. Find terminal block and connect wires as below.

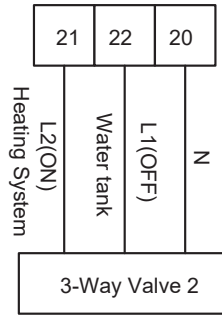

WARNING

- The 3-way valve should select water tank loop when electric power is supplied to wire (OFF) and wire (N).
- The 3-way valve should select under floor loop when electric power is supplied to wire (ON) and wire (N).
- (ON): Line signal (Water tank heating) from the main board to the 3-way valve
- (OFF): Line signal (Under floor heating) from the main board to the 3-way valve
- (N): Neutral signal from the main board to the 3-way valve

12. Other Thermal

Other thermal is allowed for the equipment and controlled in such a way that the mainboard will output 230V when outdoor temperature is lower than the set point for startup of the aother thermaluxiliary heat source.

Note: Other thermal and Optional Electric Heater CANNOT be installed at the same time.

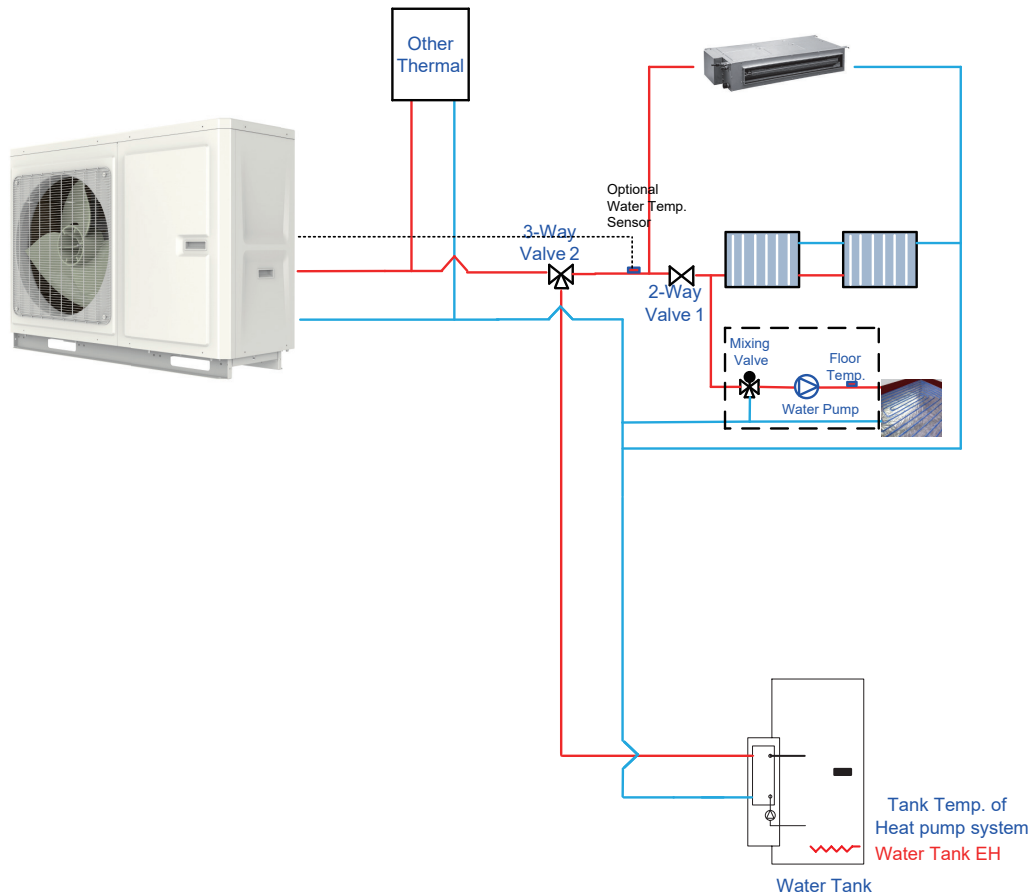

Step 2. Electric wiring work

Other thermal L and N connect to XT3~1,2.

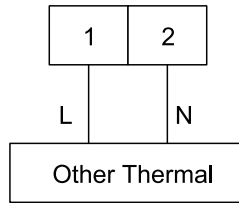

Optional water temperature sensor connect to AP1 CN16.

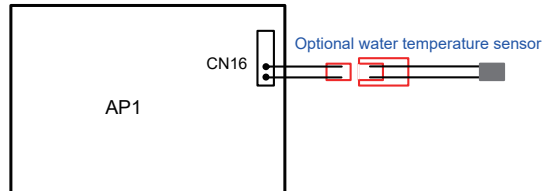

Step 3. Wired controller setting

Other thermal should be selected "with" if necessarily from COMMISSION → FUNCTION, then set switch on (outdoor)temperature and control logic(1/2/3).



13. Optional Electric Heater

Optional electric heater is allowed for the equipment and controlled in such a way when outdoor temperature is lower than the set point for startup of the optional electric heater.

Step 1. Optional electric heater installation

Optional electric heater should be installed with monobloc unit in series. Moreover, an accessory called optional water temperature sensor (5 meter length) shall be installed at the same time. The optional electric heater could be 1 group or 2 group, and only works for space heating.

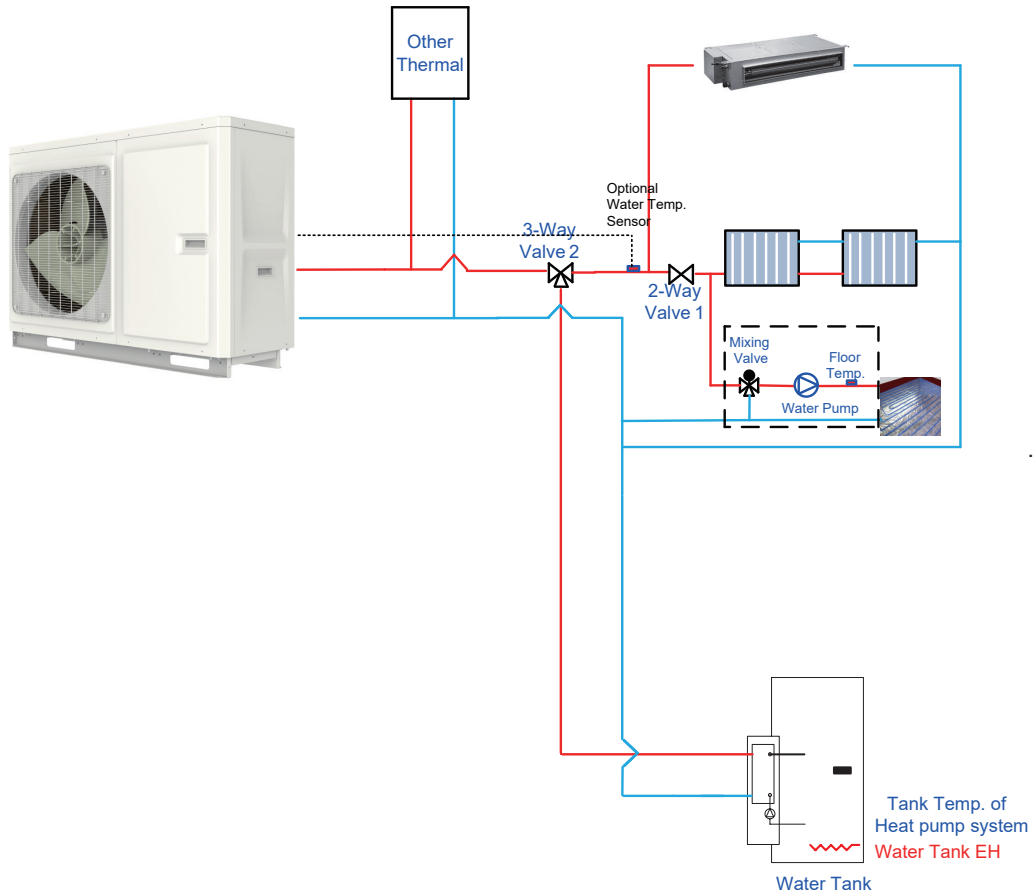

Step 2. Wired controller setting

Optional electric heater should be selected "1/2" group if necessary from COMMISSION → FUNCTION, then set switch on (outdoor) temperature and control logic(1/2).



14. Gate-controller

If there is gate control function, installation guide follow as:

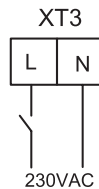

15. Charging and Discharging of Refrigerant

The unit has been charged with refrigerant before delivery. Overcharging or undercharging will cause the compressor to run improperly or be damaged. When refrigerant is required to be charged or discharged for installation, maintenance and other reasons, please follow steps below and nominal charged volume on the nameplate.

Discharging: remove metal sheets of the outer casing, connect a hose to the charging valve and then discharge refrigerant.

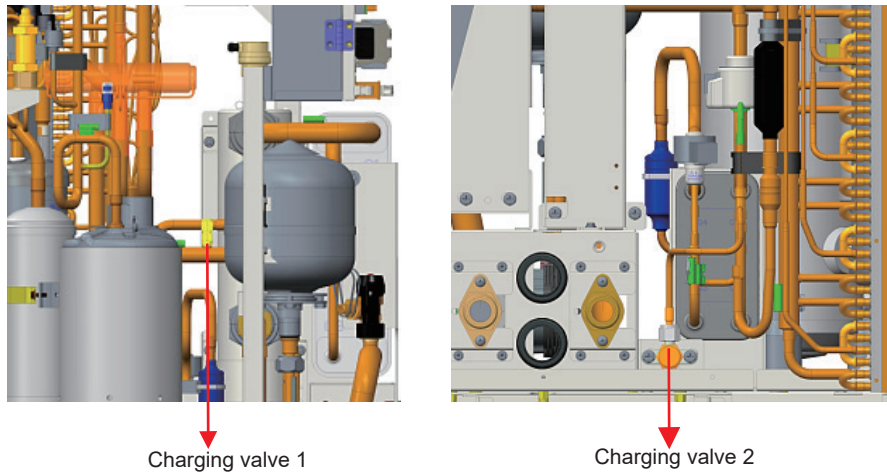

Notes

- (a) Discharge is allowed unless the unit has been stopped. (Cut off the power and repower it 1 minutes later)
- (b) Protective measures should be taken during discharging to avoid frost bites.
- (c) When discharging is finished, if vacuuming cannot be done immediately, remove the hose to avoid air or foreign matters entering the unit.
- (d) Vacuuming: when discharging is finished, use hoses to connect the charging valve, manometer and vacuum pump to vacuum the unit.

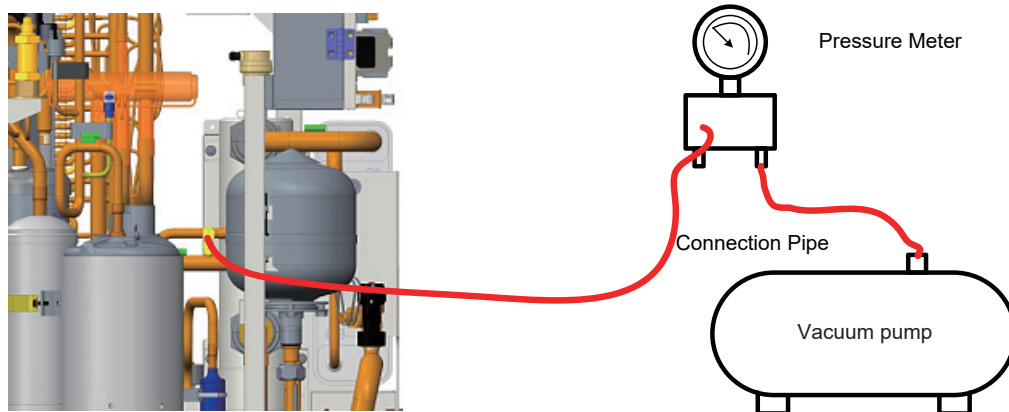

Note

When vacuuming is finished, pressure inside the unit should be kept lower than 80Pa for at least 30 minutes to make sure there is no leak. Either charging valve 1 or charging valve 2 can be used for vacuuming.

Charging: when vacuuming is finished and it is certain that there is no leak, charging can be done.

Leak Detection Methods :

- (1) The following leak detection methods are deemed acceptable for systems containing flammable refrigerants.
- (2) Electronic leak detector shall be used to detect flammable refrigerant, but the sensitivity may not be adequate, or may need re-calibration(Detection equipment shall be calibrated in a refrigerant-free area).
- (3) Ensure that the detector is not a potential source of ignition and is suitable for the refrigerant used.
- (4) Leak detection equipment shall be set at a percentage of the LFL of the refrigerant and shall be calibrated to the refrigerant employed and the appropriate percentage of gas (25% maximum) is confirmed.
- (5) Leak detection fluids are suitable for us with most refrigerant but the use of detergents containing chlorine shall be avoided as the chlorine may react with the refrigerant and corrode the copper pipe-work.

(6) If a leak is suspected, all naked flames shall be removed / extinguished. If a leakage of refrigerant is found which requires brazing, all of the refrigerant shall be recovered from the system, or isolated (by means of shut off valves) in a part of the system remote from the leak. Oxygen free nitrogen (OFN) shall then be purged through the system both before and during the brazing process.

Note

Before and during operation, use an appropriate refrigerant leak detector to monitor the operation area and make sure the technicians can be well aware of any potential or actual leakage of inflammable gas. Make sure the leak detecting device is applicable to inflammable refrigerant. For example, it should be free of sparks, completely sealed and safe in nature.

16. Installation of Insulated Water Tank

16.1 Installation measure

The insulated water tank should be installed and keep levelly within 5m and vertically within 3m from the indoor unit. It can be installed in the room.

Standing water tank must be installed vertically with the bottom on the ground, never suspended. Installation place must be firm enough and the water tank should be fixed on the wall with bolts to avoid vibration, as shown in the following figure. Weight capacity of water tank during installation should also be considered.

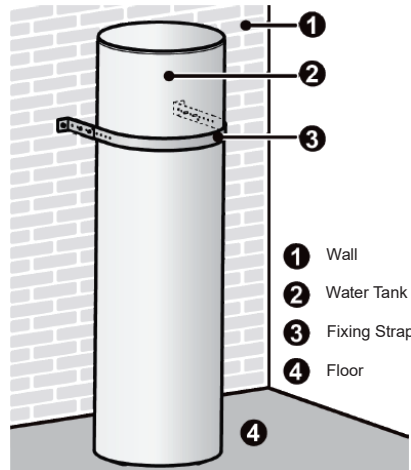

The minimum clearance from the water tank to combustible surface must be 500mm.

There should be water pipe, hot water joint and floor drain near the water tank in favor of water replenishment, hot water supply and drainage of water tank.

Connection of inlet/outlet waterway: Connect the safety check valve attached with the unit (with the arrow on it pointing at the water tank) with the water inlet of water tank with PPR pipe according to the following figure, sealing with unsintered tape. The other end of the safety check valve should connect with tap water joint. Connect the hot water pipe and water outlet of water tank with PPR pipe.

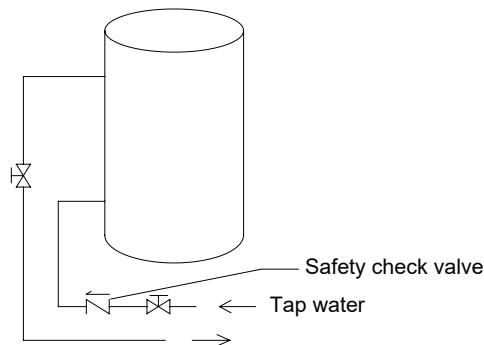

Notes

- (1) For safe use of water, water outlet/inlet of water tank must connect with a certain length of PPR pipe ,L $\geq 70 \times R2$ (cm, R is inside radius of the pipe). Moreover, heat preservation should be conducted and metal pipe cannot be used. For the first use, water tank must be full of water before the power is on.
- (2) The water may drip from the discharge pipe of the pressure-relief device and that this pipe must be left open to the atmosphere.
- (3) The pressure-relief device is to be operated regularly to remove lime deposits and to verify that it is not blocked.
- (4) The discharge pipe connected to the pressure-relief device is to be installed in a continuously downward direction and in a frost-free environment.
- (5) The appliance is intended to be permanently connected to the water mains and not connected by a hose-set.
- (6) The type of the pressure-relief device is A3J, and this device shall be installed with threaded connection.
- (7) The replenishing water pressure in water tank shall be beyond 0.2MPa and below 0.7MPa.
- (8) The method of water drainage must be operated strictly abide by the instruction on the label of the water tank.

16.2 Outline dimension and parameter of water tank

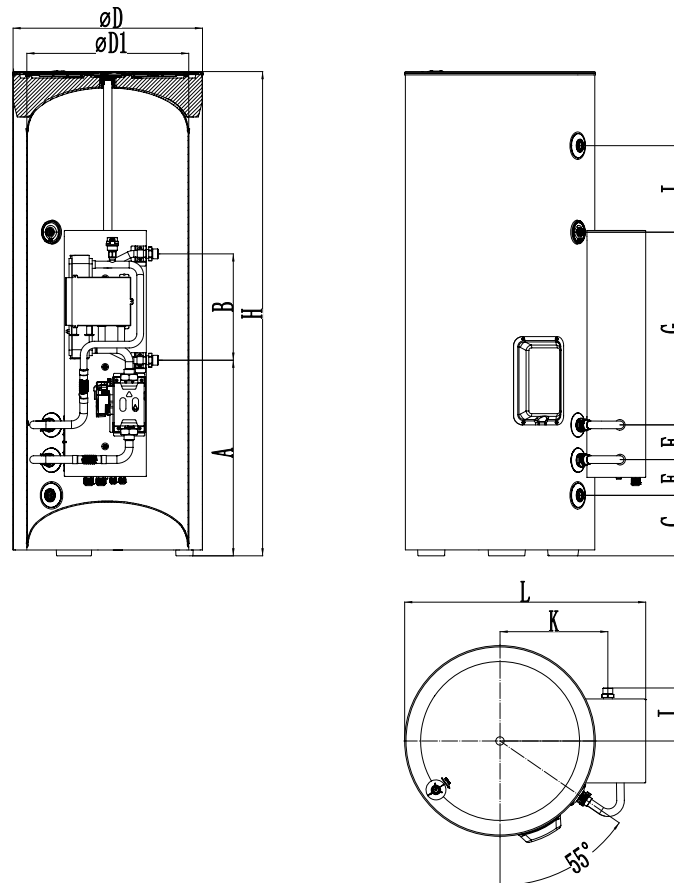

Model	SXTVD300LC/B-E	SXTVD300LC/B-M
Litre	300L	300L
D(mm)	620	620
D1(mm)	530	530
H(mm)	1585	1585
A(mm)	640	640
B(mm)	348	348

Model	SXTVD300LC/B-E	SXTVD300LC/B-M
C(mm)	198	198
E(mm)	117	117
F(mm)	114	114
G(mm)	631	631
I(mm)	283	283
J(mm)	174	174
K(mm)	353	353
L(mm)	789	789

Model		SXTVD300LC/B-E	SXTVD300LC/B-M
Outline (Diameter×H) (mm)		Φ620×1585	Φ620×1585
Package (W×D×H)(mm)		815×920×1745	815×920×1745
Net weight	kg	105	105
Gross weight	kg	132	132

Joints Dimension	
Description	Joint pipe thread
Hot water outlet of water tank	3/4"Female BSP
Circulating water inlet/outlet of water tank	3/4"Female BSP
Cooling water inlet of water tank	3/4"Female BSP
Pipe joint	3/4"Female BSP

16.3 Connection of waterway system

- (1) If connection between water tank and indoor unit should be through the wall, drill a hole Φ70 for pass of circulating water pipe. It is unnecessary if the hole is not needed.
- (2) Preparation of pipelines: Circulating water outlet/inlet pipe must be hot water pipe, PPR pipe with nominal out diameter of DN25 and S2.5 series (wall thickness of 4.2mm) being recommended. Cooling water inlet pipe and hot water outlet pipe of water tank should also be hot water pipe, PPR pipe with nominal out diameter of DN20 and S2.5 series (wall thickness of 3.4mm) being recommended. If other insulated pipes are adopted, refer to the above dimensions for out diameter and wall thickness.
- (3) Installation of circulating water inlet/outlet pipes: connect the water inlet of the unit with circulating outlet of water tank and water outlet of unit with circulating inlet of water tank.
- (4) Installation of water inlet/outlet pipes of the water tank: safety check valve, filter and cut-off valve must be installed for the water inlet pipe according to the installation sketch of the unit. At least a cut-off valve is needed for the water outlet pipe.
- (5) Installation of blow-off pipes at the bottom of water tank: connect a piece of PPR pipe with drainage outlet to floor drain. A cut-off valve must be installed in the middle of the drainage pipe and at the place where it is easy to be operated by the users.
- (6) After connection of all waterway pipelines, perform the leakage test firstly. After that, bind up the water pipes, water temp sensor and wires with wrapping tapes attached with the unit.
- (7) Refer to Installation Sketch of the Unit for details.

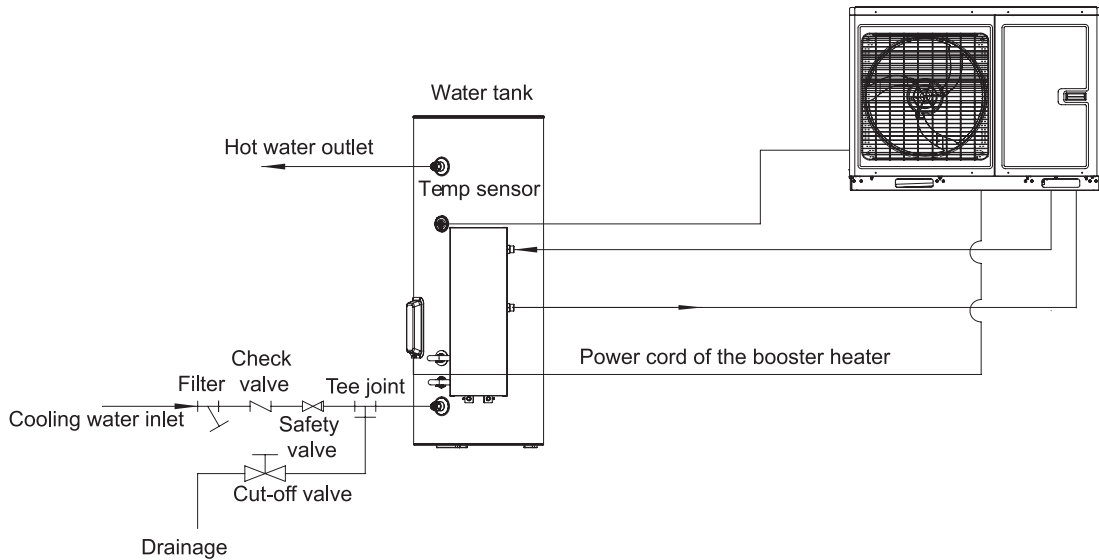

Description	Joint pipe thread
Circulating water inlet/outlet of main unit	1"Male BSP
Cooling water inlet of water tank	3/4"Female BSP
Circulating water inlet/outlet of water tank	3/4"Female BSP
Hot water outlet of water tank	3/4"Female BSP

Code	Name	QTY.	Function
0184280004P01	Retaining Plate Sub-Assy	2	Fix the water tank to the wall
70210087	Bolt M6X16	4	/
70110066	Swell Screw M8X60	2	/
0738280101	Relief Valve 1/2	1	/
035033000012	Water Pipe Connector	1	Connect the water pipe and Water inlet pipe sub-assy
06332800003	Nut	1	Install on the 3way connector
75042805	Gasket	2	Sealing function, see below blue circle
030059000120	Water inlet pipe sub-assy	2	/
05332800002	Drainage Pipe(Rubber)	1	The drainage pipe using for the relief valve to drainage the water
70814016	Pipe Hoop Φ13	1	Fix the drainage pipe
2690280000502	Extruded strip	1	Fix the water tank and avoid the damage appearance of the water tank
0184280000502P	Fixing strap	1	Fix the water tank to the wall

Notes

- (a) Distance between indoor unit and water tank should not exceed 5m levelly and 3m vertically. If higher, please contact with us. Water tank on lower and main unit on higher side is recommended.
- (b) Prepare the materials according to the above joints dimension. If cut-off valve is installed outside the room, PPR pipe is recommended to avoid freeze damage.
- (c) Waterway pipelines can't be installed until water heater unit is fixed. Do not let dust and other sundries enter into pipeline system during installation of connection pipes.
- (d) After connection of all waterway pipelines, perform leakage test firstly. After that, perform heat preservation of waterway system; meanwhile, pay more attention to valves and pipe joints. Ensure enough thickness of insulated cotton. If necessary, install heating device for pipeline to prevent the pipeline from freezing.
- (e) Hot water supplied from insulated water tank depends on pressure of water tap, so there must be supply of tap water.
- (f) During using, the cut-off valve of cooling water inlet of water tank should be kept normally on.

16.4 Requirements on water quality

Paramete	Parametric value	Unit
pH(25°C)	6.8~8.0	/
Cloudy	< 1	NTU
Chloride	< 50	mg/L
Fluoride	< 1	mg/L
Iron	< 0.3	mg/L
Sulphate	< 50	mg/L
SiO ₂	< 30	mg/L
Hardness(count CaCO ₃)	< 70	mg/L
Nitrate(count N)	< 10	mg/L
Conductance(25°C)	< 300	µs/cm
Ammonia (count N)	< 0.5	mg/L
Alkalinity(count CaCO ₃)	< 50	mg/L
Sulfid	Cannot be detected	mg/L
Oxygen consumption	< 3	mg/L
Natrium	< 150	mg/L

Note: when circulation water fails to meet requirements listed in the table above, please add anti-scale composition to keep the unit always in normal operation.

16.5 Electric wiring work

16.5.1 Wiring principle

General principles

- (1) Wires, equipment and connectors supplied for use on the site must be in compliance with provisions of regulations and engineering requirements.
- (2) Only electricians holding qualification are allowed to perform wire connection on the site.
- (3) Before connection work is started, the power supply must be shut off.
- (4) Installer shall be responsible for any damage due to incorrect connection of the external circuit.
- (5) Caution --- MUST use copper wires.
- (6) Connection of power cable to the electric cabinet of the unit
- (7) Power cables should be laid out through cabling trough, conduit tube or cable channel.
- (8) Power cables to be connected into the electric cabinet must be protected with rubber or plastic to prevent scratch by edge of metal plate.
- (9) Power cables close to the electric cabinet of the unit must be fixed reliably to make the power terminal in the cabinet free from an external force.
- (10) Power cable must be grounded reliably.

16.5.2 Specification of power supply wire and leakage switch

Power cable specifications and Leakage switch types in the following list are recommended.

Model	Power Supply	Air Break Switch	Air Break Switch (Electric heater)	Minimum Section Area of Earth Wire	Minimum Section Area of Earth Wire (Electric Heater)	Minimum Section Area of Power Wire	Minimum Section Area of Power Wire (Electric Heater)			
	V, Ph, Hz	A	A	mm ²	mm ²	mm ²	mm ²			
GRS-CQ4.0Pd/NhG3-E	230VAC 1Ph 50Hz	16	16	2.5	2.5	2×2.5	2×2.5			
GRS-CQ6.0Pd/NhG3-E			/		/		/			
GRS-CQ4.0Pd/NhG4-E			40	32	6	6	2×6	2×6		
GRS-CQ6.0Pd/NhG4-E									/	/
GRS-CQ8.0Pd/NhG3-E		16		16	2.5	1.5	4×2.5	3×1.5		
GRS-CQ10Pd/NhG3-E									/	/
GRS-CQ12Pd/NhG3-E					40	32	6	6	2×6	2×6
GRS-CQ14Pd/NhG3-E										
GRS-CQ16Pd/NhG3-E		16	16	2.5			1.5	4×2.5	3×1.5	
GRS-CQ8.0Pd/NhG4-E										/
GRS-CQ10Pd/NhG4-E		40	32	6	6	2×6	2×6			
GRS-CQ12Pd/NhG4-E								/	/	/
GRS-CQ14Pd/NhG4-E				16	16	2.5	1.5	4×2.5	3×1.5	
GRS-CQ16Pd/NhG4-E										/

Notes

- (a) Leakage Switch is necessary for additional installation. If circuit breakers with leakage protection are in use, action response time must be less than 0.1 second, leakage circuit must be 30mA.
- (b) The above selected power cable diameters are determined based on assumption of distance from the distribution cabinet to the unit less than 75m. If cables are laid out in a distance of 75m to 150m, diameter of power cable must be increased to a further grade.
- (c) The power supply must be of rated voltage of the unit and special electrical line for air-conditioning.
- (d) All electrical installation shall be carried out by professional technicians in accordance with the local laws and regulations.
- (e) Ensure safe grounding and the grounding wire shall be connected with the special grounding equipment of the building and must be installed by professional technicians.
- (f) The specifications of the breaker and power cable listed in the table above are determined based on the maximum power (maximum amps) of the unit.
- (g) The specifications of the power cable listed in the table above are applied to the conduit-guarded multi-wire copper cable (like, YJV XLPE insulated power cable) used at 40°C and resistible to 90°C (see IEC 60364-5-52). If the working condition changes, they should be modified according to the related national standard.

(h) The specifications of the breaker listed in the table above are applied to the breaker with the working temperature at 40°C. If the working condition changes, they should be modified according to the related national standard.

17. Wiring Diagram

17.1 Control board

(1) For models below

GRS-CQ4.0Pd/NhG3-E	GRS-CQ6.0Pd/NhG3-E	GRS-CQ4.0Pd/NhG4-E	GRS-CQ6.0Pd/NhG4-E
GRS-CQ8.0Pd/NhG3-E	GRS-CQ10Pd/NhG3-E	GRS-CQ12Pd/NhG3-E	GRS-CQ14Pd/NhG3-E
GRS-CQ16Pd/NhG3-E	GRS-CQ8.0Pd/NhG4-E	GRS-CQ10Pd/NhG4-E	GRS-CQ12Pd/NhG4-E
GRSCQ14Pd/NhG4-E	GRS-CQ16Pd/NhG4-E	GRS-CQ8.0Pd/NhG3-M	GRS-CQ10Pd/NhG3-M
GRS-CQ12Pd/NhG3-M	GRS-CQ14Pd/NhG3-M	GRS-CQ16Pd/ NhG3-M	GRS-CQ8.0Pd/NhG4-M
GRS-CQ10Pd/NhG4-M	GRS-CQ12Pd/NhG4-M	GRS-CQ14Pd/NhG4-M	GRS-CQ16Pd/NhG4-M

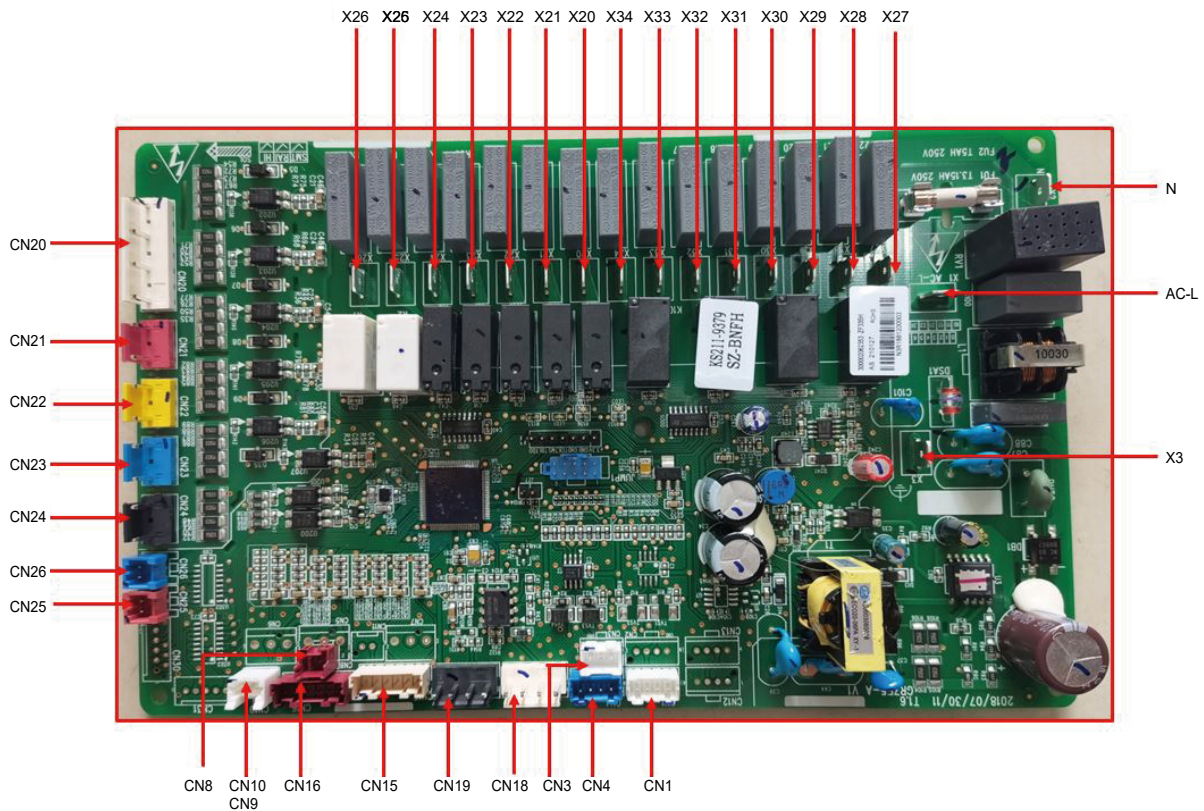

Silk Screen	Introduction
AC-L	Live wire of power supply
N	Neutral wire of power supply
X3	To the ground
X20	E-heater of water tank
X21	E-heater 1
X22	E-heater 2
X23	Other thermal by 220VAC
X24	Field supplied water pump
X25	Reserved
X26	Reserved
X27	2-way valve 1 is normally open
X28	2-way valve 1 is normally closed

Silk Screen	Introduction
X29	Water pump of the water tank
X30	Reserved
X31	Field supplied 3-way valve 1
X32	Reserved
X33	Electric three-way valve 2 open
X34	Electric three-way valve 2 closed
CN18	Build-in water pump signal(PWM)
CN19	Back-up water pump signal(PWM)-field supply
CN15	20K temperature sensor (inlet water)
CN15	20K temperature sensor (outlet water)
CN15	20K temperature sensor (refrigerant liquid line)
CN16	20K temperature sensor (refrigerant vapor line)
CN16	10K temperature sensor (leaving water for the optional electric heater)
CN16	Reserved
CN8	Remote room temperature sensor
CN9	Water tank temperature sensor
CN7	Reserved
CN6	Reserved
CN5	Reserved
CN20	Thermostat
CN21	Detection to welding protection for the optional electric heater 1
CN22	Detection to welding protection for the optional electric heater 2
CN23	Detection to welding protection for the water tank electric heater
CN24	Gate-control detection
CN25	Flow switch
CN26	Reserved
CN3	Communication with outdoor unit
CN1	Anode
CN4	Communication with control panel

(2) For models below

GRS-CQ4.0Pd/NhG3-E
GRS-CQ8.0Pd/NhG3-E
GRS-CQ16Pd/NhG3-E
GRSCQ14Pd/NhG4-E
GRS-CQ12Pd/NhG3-M
GRS-CQ10Pd/NhG4-M

GRS-CQ6.0Pd/NhG3-E
GRS-CQ10Pd/NhG3-E
GRS-CQ8.0Pd/NhG4-E
GRS-CQ16Pd/NhG4-E
GRS-CQ14Pd/NhG3-M
GRS-CQ12Pd/NhG4-M

GRS-CQ4.0Pd/NhG4-E
GRS-CQ12Pd/NhG3-E
GRS-CQ10Pd/NhG4-E
GRS-CQ8.0Pd/NhG3-M
GRS-CQ16Pd/ NhG3-M
GRS-CQ14Pd/NhG4-M

GRS-CQ6.0Pd/NhG4-E
GRS-CQ14Pd/NhG3-E
GRS-CQ12Pd/NhG4-E
GRS-CQ10Pd/NhG3-M
GRS-CQ8.0Pd/NhG4-M
GRS-CQ16Pd/NhG4-M

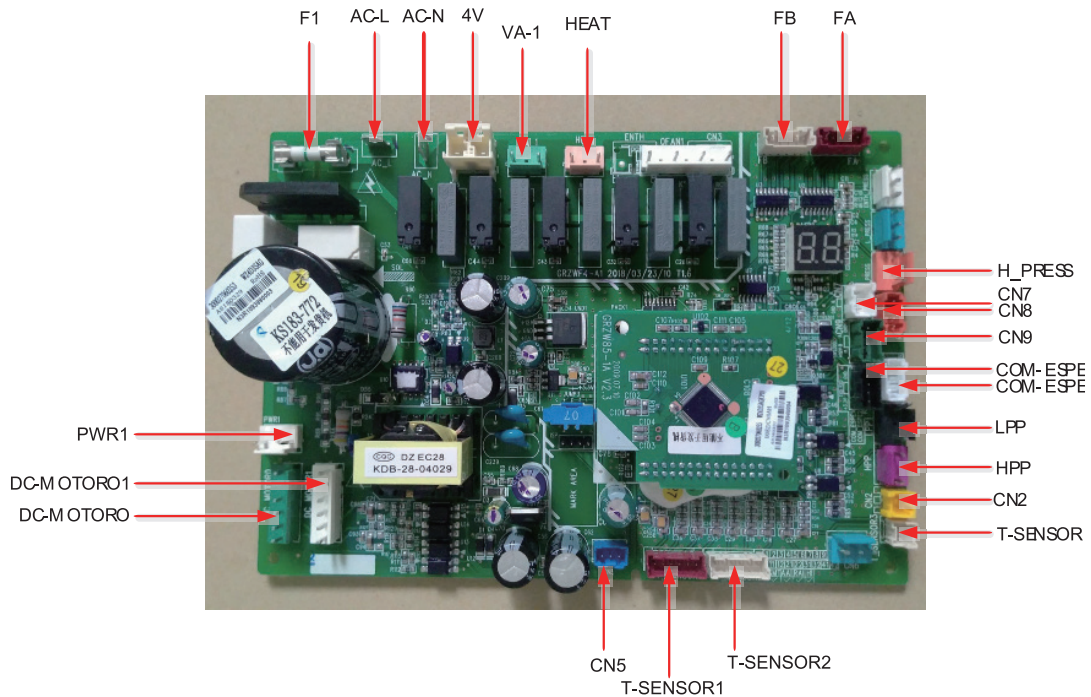

Silk Screen	Introduction
AC-L	Live wire input of power supply
N	Neutral wire input of power supply
PWR1	310V Supply 310V DC power to the drive
F1	Fuse
4V	4-way valve
VA-1	E-heater of chassis
HEAT	Electric heating tape
DC-MOTORO	1-pin: fan power supply; 3-pin: fan GND; 4-pin: +15V; 5-pin: control signal; 6-pin: feedback signal
DC-MOTORO1	1-pin: fan power supply; 3-pin: fan GND; 4-pin: +15V; 5-pin: control signal; 6-pin: feedback signal
FA	1, 2, 3, 4 signals, 5 power supply to EXV1, pipe electronic expansion valve, 1-4 pin: driving impulse output; 5 pin: +12V
FB	1, 2, 3, 4 signals, 5 power supply to EXV2, pipe electronic expansion valve, 1-4 pin: driving impulse output; 5 pin: +12V
T_SENSOR2	1,2: environment; 3,4: discharge; 5,6: suction
T_SENSOR1	1,2: economizer inlet; 3,4: economizer outlet; 5,6: defrost
H_PRESS	5V signal input of pressure sensor 1 pin: GND; 2 pin: signal input; 3 pin: +5V
HPP	1-pin: +12V, 3-pin: signal
LPP	1-pin: +12V, 3-pin: signal
CN2	1-pin: +12V, 2-pin: signal
CN7	Communication between AP1 and AP2; communication cable 2-pin: B, 3-pin: A;

Silk Screen	Introduction
CN8	1-pin:12V, 2-pin:B, 3-pin: A, 4-pin: ground, To the wired controller, communication cable;
CN9	1-pin:+12V, 2-pin:B; 3-pin:A, 4-pin: ground
COM_ESPE1	1-pin:+3.3V, 2-pin:TXD, 3-pin:RXD, 4-pin:ground
COM_ESPE2	1-pin:+3.3V, 2-pin:TXD, 3-pin:RXD, 4-pin:ground
CN5	1-pin: ground, 2-pin:+18V, 3-pin:+15V

(3) For models below

GRS-CQ4.0Pd/NhG3-E
GRS-CQ8.0Pd/NhG3-E
GRS-CQ16Pd/NhG3-E
GRSCQ14Pd/NhG4-E

GRS-CQ6.0Pd/NhG3-E
GRS-CQ10Pd/NhG3-E
GRS-CQ8.0Pd/NhG4-E
GRS-CQ16Pd/NhG4-E

GRS-CQ4.0Pd/NhG4-E
GRS-CQ12Pd/NhG3-E
GRS-CQ10Pd/NhG4-E

GRS-CQ6.0Pd/NhG4-E
GRS-CQ14Pd/NhG3-E
GRS-CQ12Pd/NhG4-E

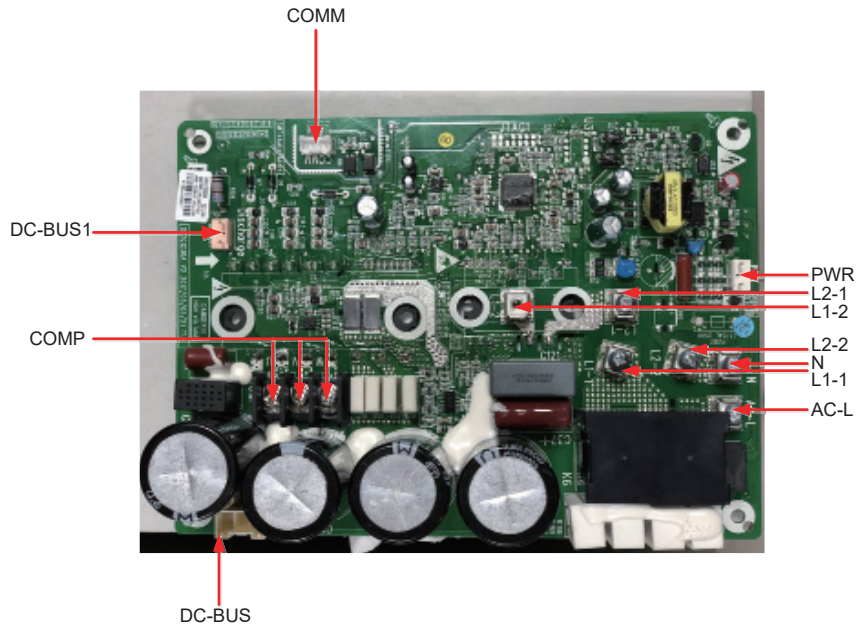

Silk Screen	Introduction
AC-L	L-OUT Live line input of the filter board
N	N-OUT Neutral line input of the filter board
L1-1	To PFC inductor brown line
L1-2	To PFC inductor white line
L2-1	To PFC inductor yellow line
L2-2	To PFC inductor blue line
COMP	Wiring board (3-pin)(DT-66BO1W-03)(variable-frequency)
COMM	Communication interface[1-3.3V,2-TX,3-RX,4-GND]
DC-BUS	DC-BUS Pin for electric discharge of the high-voltage bar during test
PWR	Power input of the drive board [1-GND,2-18V,3-15V]
DC-BUS1	Pin for electric discharge of the high-voltage bar during test

(4) For models below

 GRS-CQ4.0Pd/NhG3-E
 GRS-CQ8.0Pd/NhG3-M
 GRS-CQ16Pd/NhG3-M
 GRSCQ14Pd/NhG4-M

 GRS-CQ6.0Pd/NhG3-E
 GRS-CQ10Pd/NhG3-M
 GRS-CQ8.0Pd/NhG4-M
 GRS-CQ16Pd/NhG4-M

 GRS-CQ4.0Pd/NhG4-E
 GRS-CQ12Pd/NhG3-M
 GRS-CQ10Pd/NhG4-M

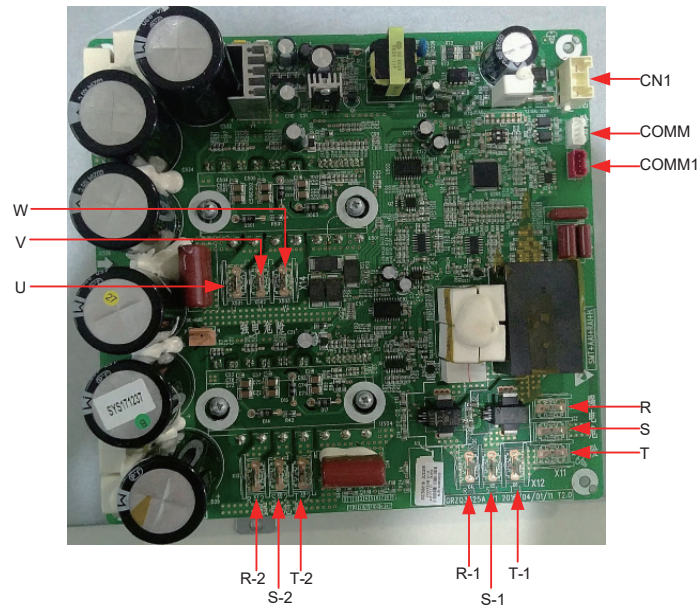
 GRS-CQ6.0Pd/NhG4-E
 GRS-CQ14Pd/NhG3-M
 GRS-CQ12Pd/NhG4-M

Silk Screen	Introduction
W	Connector to the compressor phase-W
U	Connector to the compressor phase-U
V	Connector to the compressor phase-V
R-2	Connector to reactor (input)
S-2	
T-2	
R-1	Connector to reactor (input)
S-1	
T-1	
R	Connector to filter L1-F
S	Connector to filter L2-F
T	Connector to filter L3-F
COMM1	Reserved
COMM	Communication
CN1	Switch power input

(5) For models below

GRS-CQ4.0Pd/NhG3-E
GRS-CQ8.0Pd/NhG3-E
GRS-CQ16Pd/NhG3-E
GRSCQ14Pd/NhG4-E

GRS-CQ6.0Pd/NhG3-E
GRS-CQ10Pd/NhG3-E
GRS-CQ8.0Pd/NhG4-E
GRS-CQ16Pd/NhG4-E

GRS-CQ4.0Pd/NhG4-E
GRS-CQ12Pd/NhG3-E
GRS-CQ10Pd/NhG4-E

GRS-CQ6.0Pd/NhG4-E
GRS-CQ14Pd/NhG3-E
GRS-CQ12Pd/NhG4-E

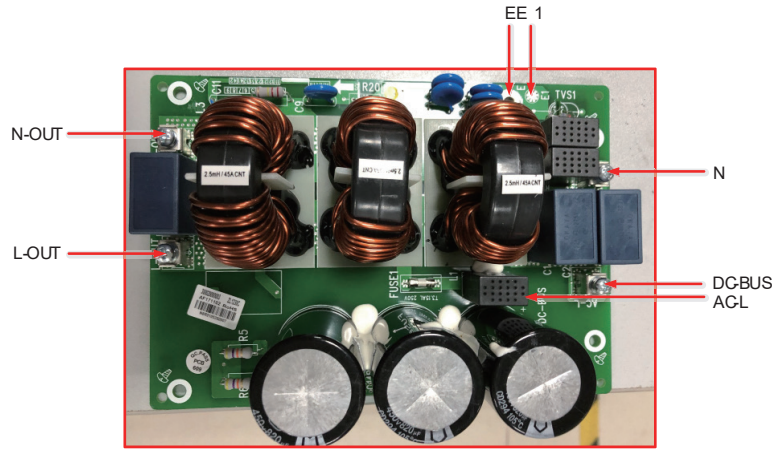

Silk Screen	Introduction
AC-L	Live line input of the main board
N	Neutral line of the power supply for the main board
L-OUT	Live line output of the filter board (to the drive and main boards)
N-OUT	Neutral line output of the filter board (to the drive board)
N-OUT1	Output neutral line
L-OUT1	Output live line
DC-BUS	DC-BUS, the other end to the drive board
E	Screw hole for grounding
E1	Grounding line, reserved

(6) For models below

GRS-CQ4.0Pd/NhG3-E
GRS-CQ8.0Pd/NhG3-M
GRS-CQ16Pd/NhG3-M
GRSCQ14Pd/NhG4-M

GRS-CQ6.0Pd/NhG3-E
GRS-CQ10Pd/NhG3-M
GRS-CQ8.0Pd/NhG4-M
GRS-CQ16Pd/NhG4-M

GRS-CQ4.0Pd/NhG4-E
GRS-CQ12Pd/NhG3-M
GRS-CQ10Pd/NhG4-M

GRS-CQ6.0Pd/NhG4-E
GRS-CQ14Pd/NhG3-M
GRS-CQ12Pd/NhG4-M



Silk Screen	Introduction
AC-L1	Input side phase L1 of the whole unit
AC-L2	Input side phase L2 of the whole unit
AC-L3	Input side phase L3 of the whole unit
N	Input side neutral line of the whole unit

Silk Screen	Introduction
L1-F	Connect to the power supply input of the drive board
L2-F	
L3-F	
N-F	Neutral line for power supply to the main control board
X11	Live line for power supply to the main control board

17.2 Electric wiring

17.2.1 Wiring principle

Refer to Section 16.5.

17.2.2 Terminal board

(1) GRS-CQ4.0Pd/NhG3-E, GRS-CQ6.0Pd/NhG3-E, GRS-CQ4.0Pd/NhG4-E, GRS-CQ6.0Pd/NhG4-E

Terminal board XT3

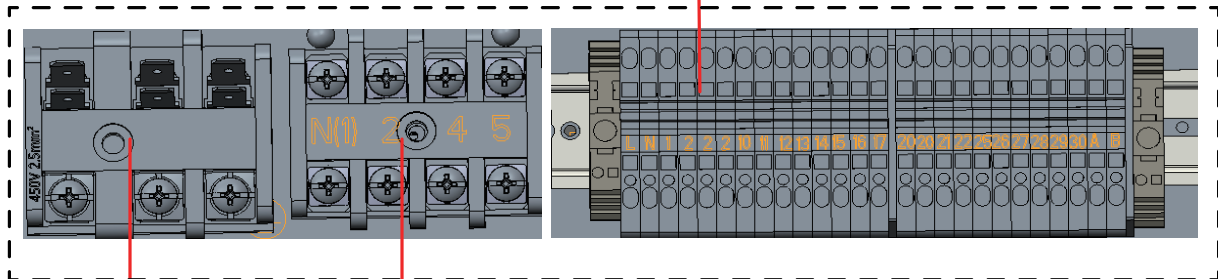
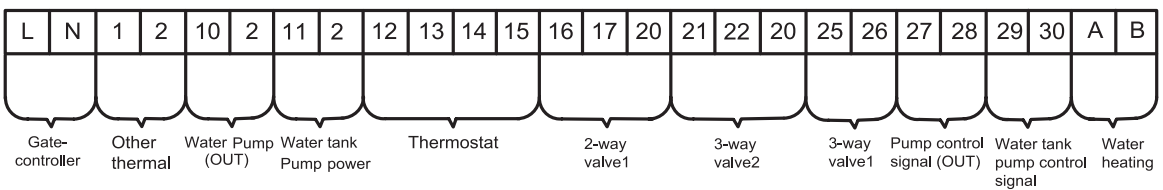

Terminal board XT1

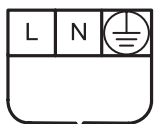

Whole unit power

Terminal board XT4

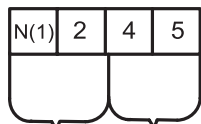

Electric heater power
Water tank auxiliary electric heater

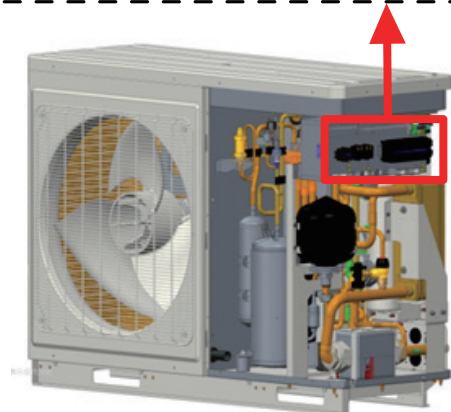

(2) GRS-CQ8.0Pd/NhG3-E, GRS-CQ10Pd/NhG3-E, GRS-CQ12Pd/NhG3-E, GRS-CQ14Pd/NhG3-E, GRS-CQ16Pd/NhG3-E, GRS-CQ8.0Pd/NhG4-E, GRSCQ10Pd/NhG4-E, GRS-CQ12Pd/NhG4-E, GRSCQ14Pd/NhG4-E, GRS-CQ16Pd/NhG4-E

Terminal board XT3

L	N	1	2	10	2	11	2	12	13	14	15	16	17	20	21	22	20	25	26	27	28	29	30	A	B
Gate-controller		Other thermal		Water Pump (OUT)		Water tank Pump power		Thermostat					2-way valve1		3-way valve2		3-way valve1		Pump control signal (OUT)		Water tank pump control signal		Water heating signal		

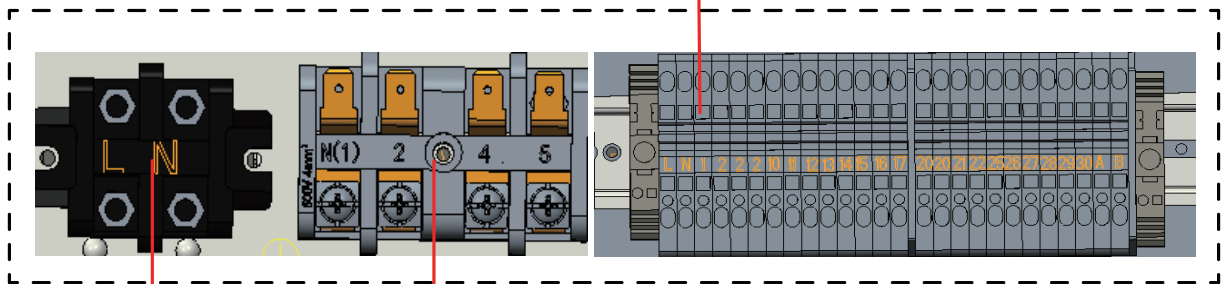

Terminal board XT1



Whole unit power

Terminal board XT4

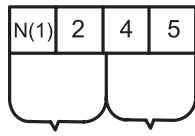

Electric heater power
Water tank auxiliary electric heater

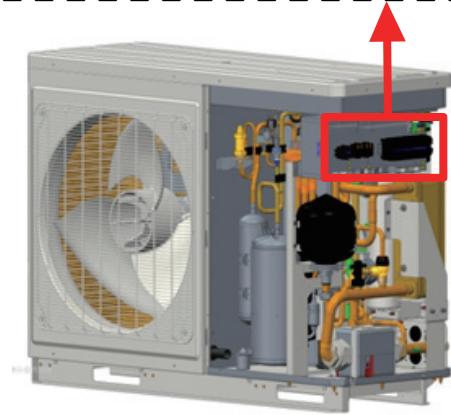

(3) GRS-CQ8.0Pd/NhG3-M, GRS-CQ10Pd/NhG3-M, GRS-CQ8.0Pd/NhG4-M, GRS-CQ10Pd/NhG4-M
Terminal board XT3

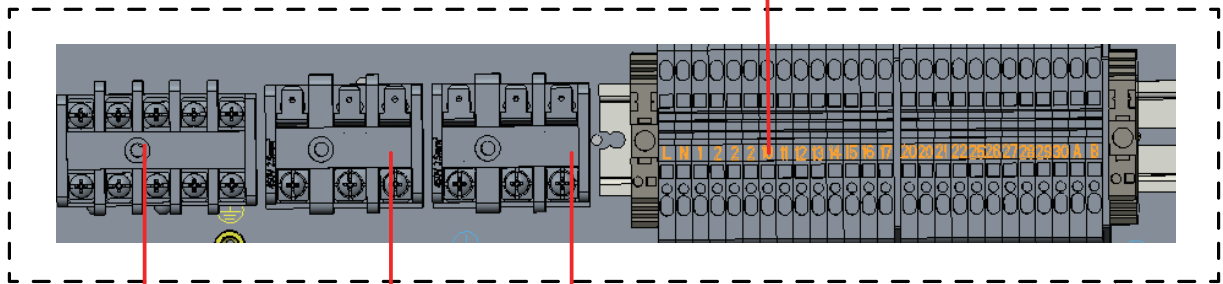
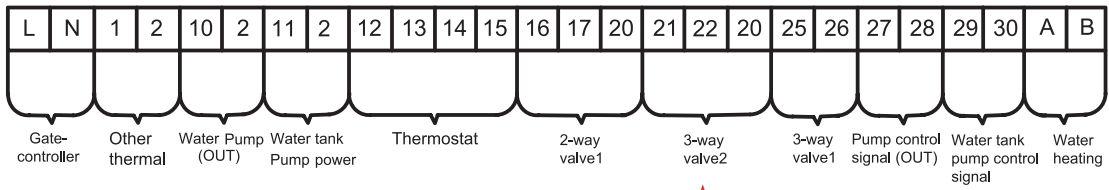

Terminal block XT1

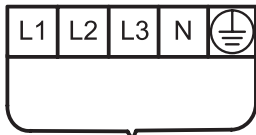

Whole unit power

Terminal block XT4

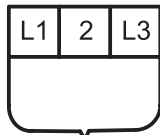

Electric heater power

Terminal block XT5

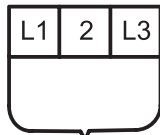

Water tank auxiliary electric heater

Terminal board with the reserved grounding terminal

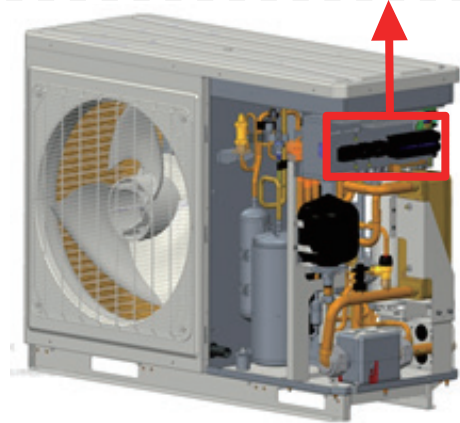

Terminal board XT3

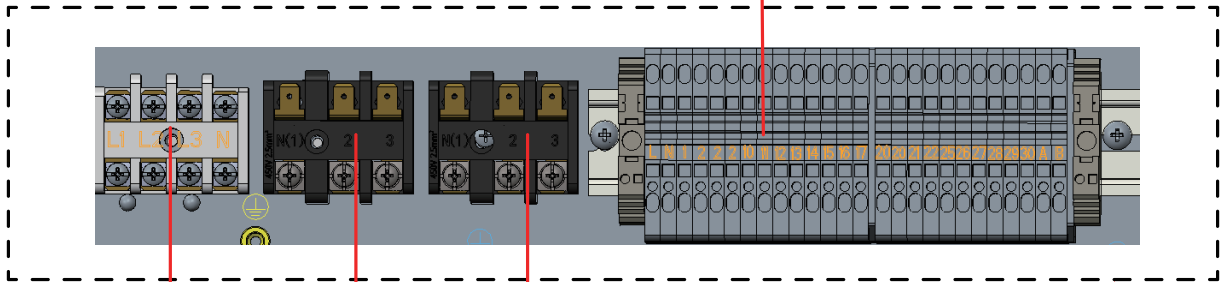
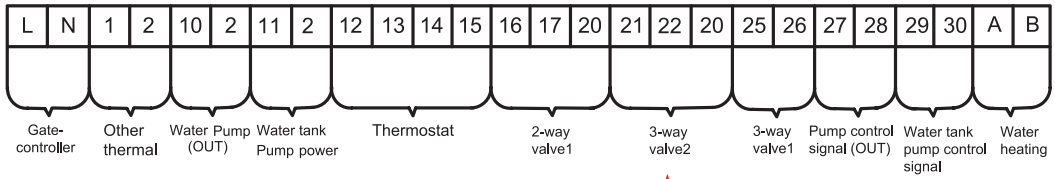

Terminal block XT1

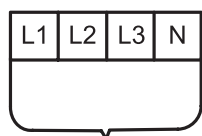

Whole unit power

Terminal block XT4

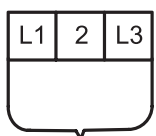

Electric heater power

Terminal block XT5

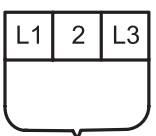

Water tank auxiliary electric heater

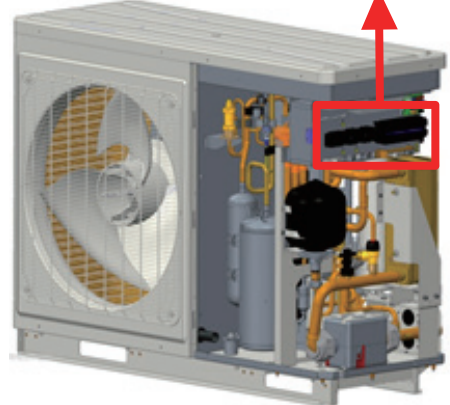

Terminal board without the reserved grounding terminal

Notes:

- (a) For the terminal board with the reserved grounding terminal, the grounding line should be connected to the grounding terminal at the terminal board
- (b) For the terminal board without the reserved grounding terminal, the grounding line should be connected to the grounding terminal at the installation board.

(4) GRS-CQ12Pd/NhG3-M, GRS-CQ14Pd/NhG3-M, GRS-CQ16Pd/NhG3-M, GRS-CQ12Pd/NhG4-M, GRS-CQ14Pd/NhG4-M, GRS-CQ16Pd/NhG4-M

Terminal board XT3

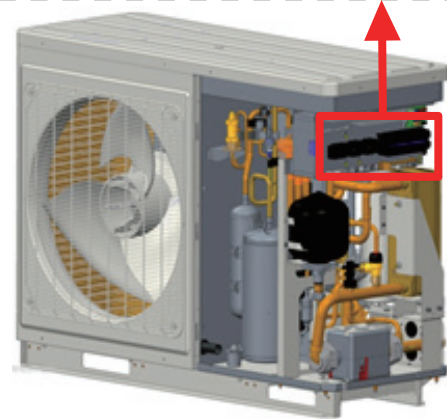
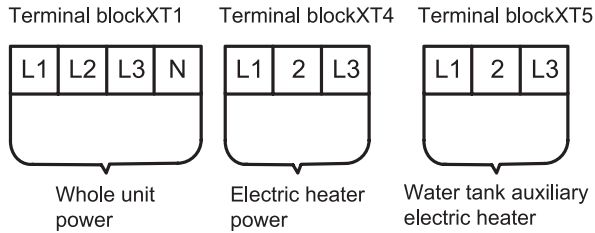
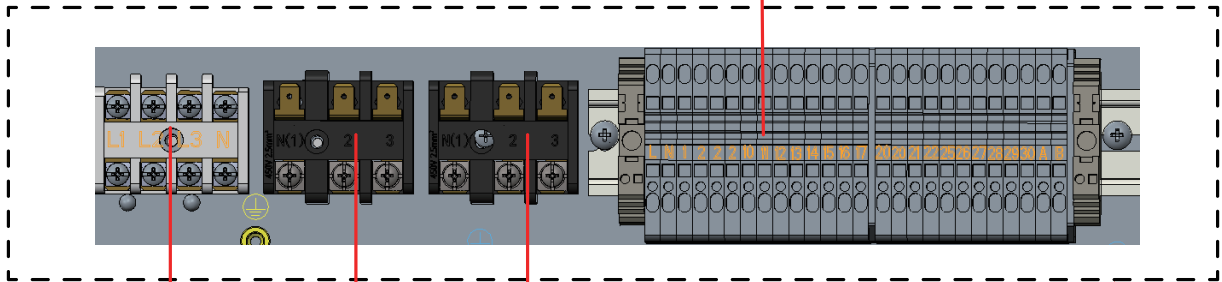
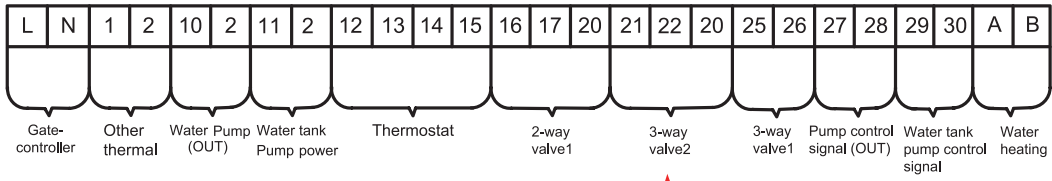

18. Commissioning

18.1 Check before startup

For safety of users and unit, the unit must be started up for check before debugging. The procedures are as below:

The following items shall be performed by qualified repair persons.		
Confirm together with the sales engineer, dealer, installing contractor and customers for the following items finished or to be finished.		
No.	Confirmation of Installation	√
1	If the contents of Application for Installation of this Unit by Installer are real. If not, debugging will be refused.	<input type="checkbox"/>
2	Is there written notice in which amendment items are shown in respect of unqualified installation?	<input type="checkbox"/>
3	Are Application for Installation and Debugging list filed together?	<input type="checkbox"/>
No.	Pre-check	√
1	Is appearance of the unit and internal pipeline system ok during conveying, carrying or installation?	<input type="checkbox"/>
2	Check the accessories attached with the unit for quantity, package and so on.	<input type="checkbox"/>
3	Make sure there is drawings in terms of electricity, control, design of pipeline and so on.	<input type="checkbox"/>
4	Check if installation of the unit is stable enough and there is enough space for operation and repair.	<input type="checkbox"/>
5	Completely test refrigerant pressure of each unit and perform leakage detection of the unit.	<input type="checkbox"/>
6	Is the water tank installed stably and are supports secure when the water tank is full?	<input type="checkbox"/>
7	Are heat insulating measures for the water tank, outlet/inlet pipes and water replenishing pipe proper?	<input type="checkbox"/>
8	Are the nilometer of water tank, water temperature indicator, controller, manometer, pressure relief valve and automatic discharge valve etc. installed and operated properly?	<input type="checkbox"/>
9	Does power supply accord with the nameplate? Do power cords conform to applicable requirements?	<input type="checkbox"/>
10	Is power supply and control wiring connected properly according to wiring diagram? Is earthing safe? Is each terminal stable?	<input type="checkbox"/>
11	Are connection pipe, water pump, manometer, thermometer, valve etc. are installed properly?	<input type="checkbox"/>
12	Is each valve in the system open or closed according to requirements?	<input type="checkbox"/>
13	Confirm that the customers and inspection personnel of Part A are at site.	<input type="checkbox"/>
14	Is Installation Check-up Table completed and signed by the installation contractor?	<input type="checkbox"/>
Attention: If there is any item marked with ×, please notify the contractor. Items listed above are just for reference.		
Confirmed Items after pre-checking	General Evaluation: Debugging <input type="checkbox"/> Amendment <input type="checkbox"/>	
	Judge the following items (if there is not any filling, qualification will be regarded.)	
	a: Power supply and electric control system	b: Loading calculation
	c: Heating problems of Unit	d: Noise problem
	e: Pipeline problem	f: Others
	Normal debugging work can't be performed unless all installation items are qualified. If there is any problem, it must be solved firstly. The installer will be responsible for all costs for delay of debugging and re-debugging incurred by any problem which is not solved immediately.	
	Submit schedule of amending reports to installer.	
	Is the written amending report which should be signed after communication provided to installer?	
Yes () No ()		

18.2 Test run

Test run is testing whether the unit can run normally via preoperation. If the unit cannot run normally, find and solve problems until the test run is satisfactory. All inspections must meet the requirements before performing the test run. Test run should follow the content and steps of the table below:

The following procedure should be executed by experience and qualified maintenance men.	
No.	Start up the pretest procedure
Notice: before test, ensure that all power must be cut off, including the far- end power switch, otherwise, it may cause casualty.	
1	Ensure that the compressor of the unit is preheated for 8h.
⚠ Caution: heat the lubricating oil at least 8h in advance to prevent refrigerant from mixing with the lubricating oil, which may cause damage to the compressor when starting up the unit.	
2	Check whether the phase sequence of the main power supply is correct. If not, correct the phase sequence firstly.
⚠ Recheck the phase sequence before start-up to avoid reverse rotation of the compressor which may damage the unit.	
3	Apply the universal electric meter to measure the insulation resistance between each outdoor phase and earth as well as between phases.
⚠ Caution: defective earthing may cause electric shock.	
No.	Ready to start
1	Cut off all temporary power supply, resume all the insurance and check the electricity for the last time.
	Check the power supply and voltage of the control circuit; _____ V must be $\pm 10\%$ within the range of rated operating power.
No.	Start up the unit
1	Check all the conditions needed to start up the unit: operation mode, required load etc.
2	Start up the unit, and observe the operation of compressor, electric expanding valve, fan motor and water pump etc.
	Note: the unit will be damaged under abnormal running state. Do not operate the unit in states of high pressure and high current.
Others:	
Items for acceptance after commissioning	Estimation or suggestion on the general running situation: good, modify
	Identify the potential problem (nothing means the installation and commissioning are in accordance with the requirements.)
	a. problem of power supply and electric control system:
	b. problem of load calculation:
	c. outdoor refrigerant system:
	d. noise problem:
	e. problem of indoor and piping system:
	h. other problems:
During operation, it is needed to charge for the maintenance due to non-quality problems such as incorrect installation and maintenance.	
Acceptance	
Is the user trained as required? Please sign. Yes() No()	

19. Daily Operation and Maintenance

In order to avoid damage of the unit, all protecting devices in the unit had been set before delivery, so please do not adjust or remove them.

For the first startup of the unit or next startup of unit after long-period stop (above 1 day) by cutting off the power, please electrify the unit in advance to preheat the unit for more than 8 hours.

Never put sundries on the unit and accessories. Keep dry, clean and ventilated around the unit.

Remove the dust accumulated on the condenser fin timely to ensure performance of the unit and to avoid stop of the unit for protection.

In order to avoid protection or damage of the unit caused by blockage of the water system, clean the filter in water system periodically and frequently check water replenishing device.

In order to ensure anti-freezing protection, never cut off the power if ambient temperature is below zero in winter.

In order to avoid frost crack of the unit, water in the unit and pipeline system not used for a long period should be drained. In addition, open the end cap of the water tank for drainage.

When the water tank has been installed but the water tank is set to "Without", functions relative with the water tank will not work and the displayed water tank temperature will always be "-30". In this case, the water tank would suffer frostbite and even other severe influences under low temperature. Therefore, once the water tank has been installed, the water tank must be set to "With", otherwise GREE will not be responsible for this abnormal operation.

Never frequently make the unit on/off and close the manual valve of the water system during operation of the unit by users.

Ensure frequent check to the working condition of each part to see if there is oil stain at pipeline joint and charge valve to avoid leakage of refrigerant.

If malfunction of the unit is out of control of users, please timely contact with authorized service center.

Notes

The water pressure gage is installed in the returning water line in the unit. Please adjust the hydraulics system pressure according to next item:

- (1) If the pressure is less than 0.5 bar, please recharge the water immediately.
- (2) When recharging, the hydraulics system pressure should be not more than 2.5 Bar.

Malfunctions	Reasons	Troubleshooting
Compressor does not start up	Power supply has problem. Connection wire is loose. Malfunction of mainboard. Malfunction of compressor.	Phase sequence is reverse. Check out and re-fix. Find out the reasons and repair. Replace compressor.
Heavy noise of fan	Fixing bolt of fan is loose. Fan blade touches shell or grill. Operation of fan is unreliable.	Re-fix fixing bolt of fan. Find out the reasons and adjust. Replace fan.
Heavy noise of compressor	Liquid slugging happens when liquid refrigerant enters into compressor. Internal parts in compressor are broken.	Check if expansion valve is failure and temp. sensor is loose. If that, repair it. Replace compressor.
Water pump does not run or runs abnormally	Malfunction of power supply or terminal. Malfunction of relay. There is air in water pipe.	Find out the reasons and repair. Replace relay. Evacuate.
Compressor starts or stops frequently	Poor or excess refrigerant. Poor circulation of water system. Low load.	Discharge or add part of refrigerant. Water system is blocked or there is air in it. Check water pump, valve and pipeline. Clean water filter or evacuate. Adjust the load or add accumulating devices.
The unit does not heat although compressor is running	Leakage of refrigerant. Malfunction of compressor.	Repair by leakage detection and add refrigerant. Replace compressor.
Poor efficiency of hot water heating	Poor heat insulation of water system. Poor heat exchange of evaporator. Poor refrigerant of unit. Blockage of heat exchanger at water side.	Enhance heat insulation efficiency of the system. Check if air in or out of unit is normal and clean evaporator of the unit. Check if refrigerant of unit leaks. Clean or replace heat exchanger.

19.1 Recovery

When removing refrigerant from a system, either for servicing or decommissioning, it is recommended good practice that all refrigerants are removed safely.

When transferring refrigerant into cylinders, ensure that only appropriate refrigerant recovery cylinders are employed. Ensure that the correct number of cylinders for holding the total system charge are available. All cylinders to be used Ensure that the correct number of cylinders for holding the total system charge are available. All cylinders to be used are designated for the recovered refrigerant and labelled for that refrigerant (i.e. special cylinders for the recovery of refrigerant). Cylinders shall be complete with pressure relief valve and associated shut-off valves in good working order. Empty recovery cylinders are evacuated and, if possible, cooled before recovery occurs.

The recovery equipment shall be in good working order with a set of instructions concerning the equipment that is at hand and shall be suitable for the recovery of flammable refrigerants.

In addition, a set of calibrated weighing scales shall be available and in good working order.

Hoses shall be complete with leak-free disconnect couplings and in good condition. Before using the recovery machine, check that it is in satisfactory working order, has been properly maintained and that any associated electrical components are sealed to prevent ignition in the event of a refrigerant release. Consult manufacturer if in doubt.

The recovered refrigerant shall be returned to the refrigerant supplier in the correct recovery cylinder, and the relevant Waste Transfer Note arranged. Do not mix refrigerants in recovery units and especially not in cylinders.

If compressors or compressor oils are to be removed, ensure that they have been evacuated to an acceptable level to make certain that flammable refrigerant does not remain within the lubricant. The evacuation process shall be carried out prior to returning the compressor to the suppliers. Only electric heating to the compressor body shall be employed to accelerate this process. When oil is drained from a system, it shall be carried out safely.

19.2 Decommissioning

Before carrying out this procedure, it is essential that the technician is completely familiar with the equipment and all its detail. It is recommended good practice that all refrigerants are recovered safely. Prior to the task being carried out, an oil and refrigerant sample shall be taken in case analysis is required prior to re-use of reclaimed refrigerant. It is essential that electrical power is available before the task is commenced.

- a) Become familiar with the equipment and its operation.
- b) Isolate system electrically.
- c) Before attempting the procedure ensure that: mechanical handling equipment is available, if required, for handling refrigerant cylinders; all personal protective equipment is available and being used correctly; the recovery process is supervised at all times by a competent person; recovery equipment and cylinders conform to the appropriate standards.
- d) Pump down refrigerant system, if possible.
- e) If a vacuum is not possible, make a manifold so that refrigerant can be removed from various parts of the system.
- f) Make sure that cylinder is situated on the scales before recovery takes place.
- g) Start the recovery machine and operate in accordance with manufacturer's instructions.
- h) Do not overfill cylinders. (No more than 80 % volume liquid charge).
- i) Do not exceed the maximum working pressure of the cylinder, even temporarily.
- j) When the cylinders have been filled correctly and the process completed, make sure that the cylinders and the equipment are removed from site promptly and all isolation valves on the equipment are closed off.
- k) Recovered refrigerant shall not be charged into another refrigeration system unless it has been cleaned and checked.

19.3 Notice before seasonal use

- (1) Check whether air inlets and air outlets of indoor and outdoor units are blocked
- (2) Check whether ground connection is reliable or not
- (3) If unit starts up after not operating for a long time, it should be power on 8 hours before operation starts so as to preheat the outdoor compressor
- (4) Precautions for Freeze Protection in Winter

Under subzero climatic conditions in winter, anti-freeze fluid must be added into the water cycle and external water pipes should be properly insulated. Glycol solution is recommended as the anti-freeze fluid.

Concentration %	Freezing Temp °C	Concentration %	Freezing Temp °C	Concentration %	Freezing Temp °C
4.6	-2	19.8	-10	35	-21
8.4	-4	23.6	-13	38.8	-26
12.2	-5	27.4	-15	42.6	-29
16	-7	31.2	-17	46.4	-33

Note: "Concentration" listed in the table above indicates the mass concentration.

19.4 Safety considerations

(1) Pressure relief of the water tank

The water may drip from the discharge pipe of the pressure-relief device and that this pipe must be left open to the atmosphere.

The pressure-relief device is to be operated regularly to remove lime deposits and to verify that it is not blocked

A discharge pipe connected to the pressure-relief device is to be installed in a continuously downward direction and in a frost-free environment.

(2) Installation of the water tank safety valve

Pressure of the water tank will gradually increase during heating and a safety valve is required to discharge some water for pressure relief. If not or installed incorrectly, it would cause the water tank to expand, to be deformed, to be damaged or even lead to personal injury. The arrow → of the water tank safety valve shall point toward the water tank. No cut-off valve or check valve is required between the safety valve and the water tank, as the safety valve would fail to work. The safety valve requires the drain hose for installation and should be securely fastened. The drain hose should be led naturally downward into the floor drain without any convex bow, intertwist or fold. Extra length of the drain hose inside the floor drain should be cut away in case of poor drainage or water freeze under low atmospheric temperature. The recommended action pressure for the safety valve is 0.7Mpa, the same as that for the water tank. Do comply with this requirement for section of the safety valve; otherwise the water tank would fail to work normally.

The drain pipe should go downwards and be connected with the floor drain. Its outlet should be lower than the bottom of the water tank. A cutoff valve is required for the drain pipe and should be installed where it is convenient for operation.

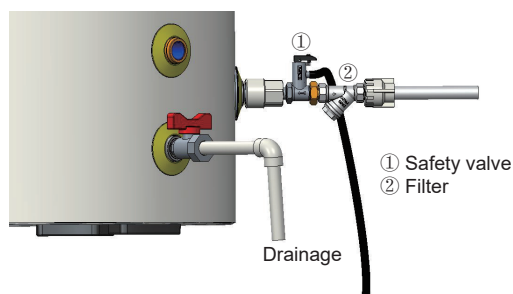

Installation Mode 1 of the Tap Water Safety Valve (Inlet Water Pressure =0.1~0.5MPa)

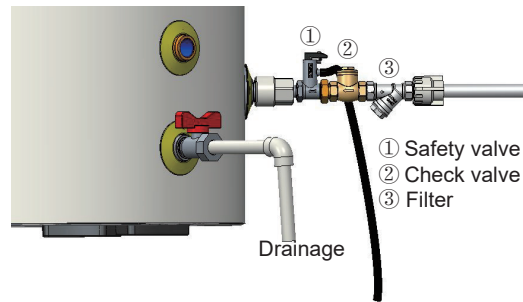

Installation Mode 2 of the Tap Water Valve (Inlet Water Pressure<0.1MPa)

The safety valve is bypass installed in the installation mode 2. A check valve is required at the tap water pipe and installed horizontally with the valve cap vertically upwards and the arrow direction at the valve body the same as the water flow.

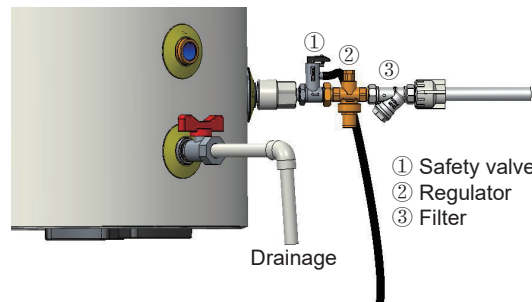

Installation Mode 3 of the Tap Water Safety Valve (Inlet Water Pressure>0.5MPa)

A pressure maintaining valve is required in the installation mode 3 to make sure the water tank pressure keep within 0.3~0.5MPa. The arrow direction of the pressure maintaining valve should be the same as the water flow.

Note: the filter, safety valve, check valve, pressure maintaining valve, cut-off valve and hose for installation are not delivered with the main unit and should be prepared by the client.

19.5 Maintenance of the water tank

19.5.1 Water input and drainage of water tank

- (1) Operation process for water input on the water tank
 - Cut off the power supply and open the cut-off valve at the water inlet of the tap faucet;
 - Open the cut-off valve at the hot water drain outlet and valve in user water use site;
 - Close the valve in user water use site when water is flowing out from user water use site;
 - Complete water input operation and reenergize the unit.
- (2) Operation process for drainage on the water tank
 - Cut off the power supply and close the cut-off valve at the water outlet of the tap faucet;
 - Open the cut-off valve at the hot water drain outlet and valve in user water use site;
 - Open the cut-off valve on the joint (3-way) pipe;
 - Close the drainage cut-off valve after draining water on the water tank to complete drainage operation.

19.5.2 Periodic cleaning for water tank

Please clean the water tank periodically to get good-quality water according to the following steps:

- (1) Cut off the power supply.
- (2) Close the cut-off valve at the water inlet of the water tank.
- (3) Open the cut-off valve at the hot water drain outlet and valve in user water use site.
- (4) Open the cut-off valve in joint (3-way) connector, and wait for drainage of water inside water tank.
- (5) Close the cut-off valve in joint (3-way) connector, open the cut-off valve at the water inlet of the water tank, close the cut-off valve at the water inlet when water flows from user water use site, then reopen the cut-off valve in joint (3-way) connector, repeat the drainage operation, close the cut-off valve in joint (3-way) connector when water discharged is clean.

- (6) Conduct water input for the water tank according to water input operation.
- (7) Water tank cleaning completed and energize it.

19.5.3 Mg-stick replacement

- (1) To improve durability of the water tank, a Mg-Stick is installed inside the water tank. Generally, the Mg-Stick has a lifespan of two to three years. However, if the quality of water used by the water heater is poor, the Mg-Stick lifespan will be shortened. For Mg-Stick replacement, perform the following steps:
- (2) Before removing the Mg-Stick, drain the water tank by following drainage operations.
- (3) Open the cap on the mounting mouth for the Mg-Stick in the water tank.
- (4) Use a hex key to unscrew the Mg-Stick component, and then steadily removed the magnesium to prevent it from falling into the inner container of the water tank.
- (5) Install a new Mg-Stick component into the mounting mouth of the Mg-Stick, and then tighten it using a hex key.
- (6) Close the cap, and replenish water by following water replenishment operations.

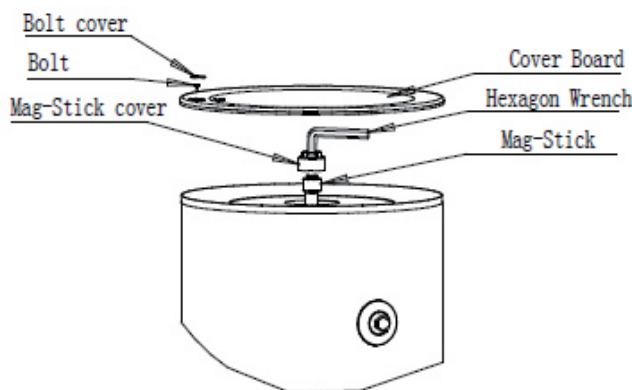

Note: the Mg-Stick must be replaced by professional maintenance personnel. Please directly contact your local dealer or authorized service center for service support.

19.6 Maintenance of the unit

19.6.1 Error code list

- (1) Complete unit code

Code Indication	Error Name	Source of Error Signal	Control Description
F4	Outdoor environment temp sensor error	<ul style="list-style-type: none"> ① The plug on temperature sensor is not correctly connected to the socket on mainboard. ② The resistance of temperature sensor is not correct. 	It will be automatically cleared after the failure is removed.
d6	Defrost temp sensor error	<ul style="list-style-type: none"> ① The plug on temperature sensor is not correctly connected to the socket on mainboard. ② The resistance of temperature sensor is not correct. 	It will be automatically cleared after the failure is removed.

Code Indication	Error Name	Source of Error Signal	Control Description
F7	Discharge temp sensor error	① The plug on temperature sensor is not correctly connected to the socket on mainboard. ② The resistance of temperature sensor is not correct.	It will be automatically cleared after the failure is removed.
F5	Suction temp sensor error	① The plug on temperature sensor is not correctly connected to the socket on mainboard. ② The resistance of temperature sensor is not correct.	It will be automatically cleared after the failure is removed.
EF	Outdoor fan error	① Mainboard of outdoor unit is damaged. ② The wire connecting the wiring terminals of the mainboard breaks.	If it occurs for 6 times during one hour, it is cleared by de-energization. If it occurs for less than 6 times, it will be automatically cleared.
E1	Comp High-pressure protection	① Comp High-pressure switch is broken or the wiring is loose. ② The water in the tank is not enough. ③ The installation of tank temp sensor is not correct. ④ The gas valve and liquid valve are not fully open. ⑤ The electronic expansion valve can not work normally.	De-energize the unit and then, energize it again. If the malfunction is removed, the code will be cleared.
E3	Comp Low- pressure protection	① Comp Low-pressure switch is broken or the wiring is loose. ② The system has leaked. ③ The fans stop running or reverse.	It will be cleared if the malfunction is removed after the unit has been turned off.
E4	Comp Discharge temp protection	① The resistance of temperature sensor is not correct. ② The electronic expansion valve is blocked. ③ The system has leaked. ④ Mainboard of outdoor unit is damaged.	It will be cleared if the discharge temp is lower than 92℃.
C5	Cpacity switch error	① The jumper trips off.	De-energize the unit and then energize it again. If the malfunction is removed, the code will be cleared.

Code Indication	Error Name	Source of Error Signal	Control Description
E6	Communication malfunction(between outdoor and indoor mainboard0.	<ul style="list-style-type: none"> ① The communication line of the unit is not connected. ② The communication line is not through. ③ The communication line of the unit is not connected correctly. ④ The two ends of communication line are not mounted with magnetic ring. ⑤ The outdoor unit is not electrically powered 	It will be cleared once communication recovers or it will be shown all the time
E6	Communication malfunction(between outdoor mainboard and wired controller)	<ul style="list-style-type: none"> ① The communication line of the unit is not connected. ② The communication line is not through. ③ The communication line of the unit is not connected correctly. ④ The two ends of communication line are not mounted with magnetic ring. ⑤ The outdoor unit is not electrically powered 	It will be cleared once communication recovers or it will be shown all the time
Fc	High pressure switch error	<ul style="list-style-type: none"> ① The sensor is damaged. ② The wire of the sensor is loose. ③ The position of the sensor is wrong 	It will be automatically cleared after the failure is removed.
F9	Outlet temperature sensor error	<ul style="list-style-type: none"> ① The plug on temperature sensor is not correctly connected to the socket on mainboard. ② The resistance of temperature sensor is not correct. 	It will be automatically cleared after the failure is removed.
dH	Backup outlet temperature sensor error	<ul style="list-style-type: none"> ① The plug on temperature sensor is not correctly connected to the socket on mainboard. ② The resistance of temperature sensor is not correct. 	It will be automatically cleared after the failure is removed.
F1	Lliquid pipe temperature sensor Inside refrigerant error	<ul style="list-style-type: none"> ① The plug on temperature sensor is not correctly connected to the socket on mainboard. ② The resistance of temperature sensor is not correct. 	It will be automatically cleared after the failure is removed.

Code Indication	Error Name	Source of Error Signal	Control Description
FE	The first sanitary water tank temperature sensor error	① The plug on temperature sensor is not correctly connected to the socket on mainboard. ② The resistance of temperature sensor is not correct.	It will be automatically cleared after the failure is removed.
F3	Gas pipe temperature sensor inside refrigerant error	① The plug on temperature sensor is not correctly connected to the socket on mainboard. ② The resistance of temperature sensor is not correct.	It will be automatically cleared after the failure is removed.
F0	Remote room temperature sensor error	① The plug on temperature sensor is not correctly connected to the socket on mainboard. ② The resistance of temperature sensor is not correct.	It will be automatically cleared after the failure is removed.
Ec	Water switch error	① The switch is damaged. ② The wire of the switch is loose. ③ The position of the switch is wrong	It will be cleared after the unit is turned off.
E2	Indoor anti-frozen protection	① The resistance of temperature sensor is not correct. ② The electronic expansion valve can not work normally.	It will be cleared once malfunction is removed or it will be shown all the time; but it will be cleared immediately when switching operation mode.
Ed	outlet temperature High-temp protection	① The resistance of temperature sensor is not correct. ② The plug on temperature sensor is not correctly connected to the socket on mainboard. ③ Mainboard of outdoor unit is damaged.	De-energize the unit and then, energize it again. If the malfunction is removed, the code will be cleared.
EH	the first internal electric heater connection Malfunction	① The AC contactor is damaged.	De-energize the unit and then, energize it again. If the malfunction is removed, the code will be cleared.
EH	second internal electric heater connection Malfunction	① The AC contactor is damaged.	De-energize the unit and then, energize it again. If the malfunction is removed, the code will be cleared.
EH	sanitary water tank electric heater connection Malfunction	① The AC contactor is damaged.	De-energize the unit and then, energize it again. If the malfunction is removed, the code will be cleared.

(2) Drive failure code

Item		Display on Nixie Tube of the Unit	Display on Wired Controller	Others
Inverter Drive Failure	Reset of Drive System	P0	Reset of Drive System	
	Startup Failure of Compressor	Lc	Startup Failure of Compressor	
	Phase Protection	Ld	Phase Protection	
	Current protection of compressor	P5	Current protection of compressor	
	Communication failure	P6	Communication failure	
	Sensor failure of heat sink	P7	Sensor failure of heat sink	
	Overheat protection of heat sink	P8	Overheat protection of heat sink	
	AC current protection (input side)	PA	AC current protection (input side)	
	Current sensor failure	Pc	Current sensor failure	
	Connection protection of sensor	Pd	Connection protection of sensor	
	Overvoltage protection	PH	Overvoltage protection	
	Under-voltage protection	PL	Under-voltage protection	
	Abnormality of input AC voltage	PP	Abnormality of input AC voltage	
	Charge circuit failure	PU	Charge circuit failure	
	IPM protection	H5	IPM protection	
	Desynchronizing of motor	H7	Desynchronizing of motor	
PFC abnormality	Hc	PFC abnormality		

19.6.2 Flow chart of troubleshooting

(1) Comp high-pressure protection E1

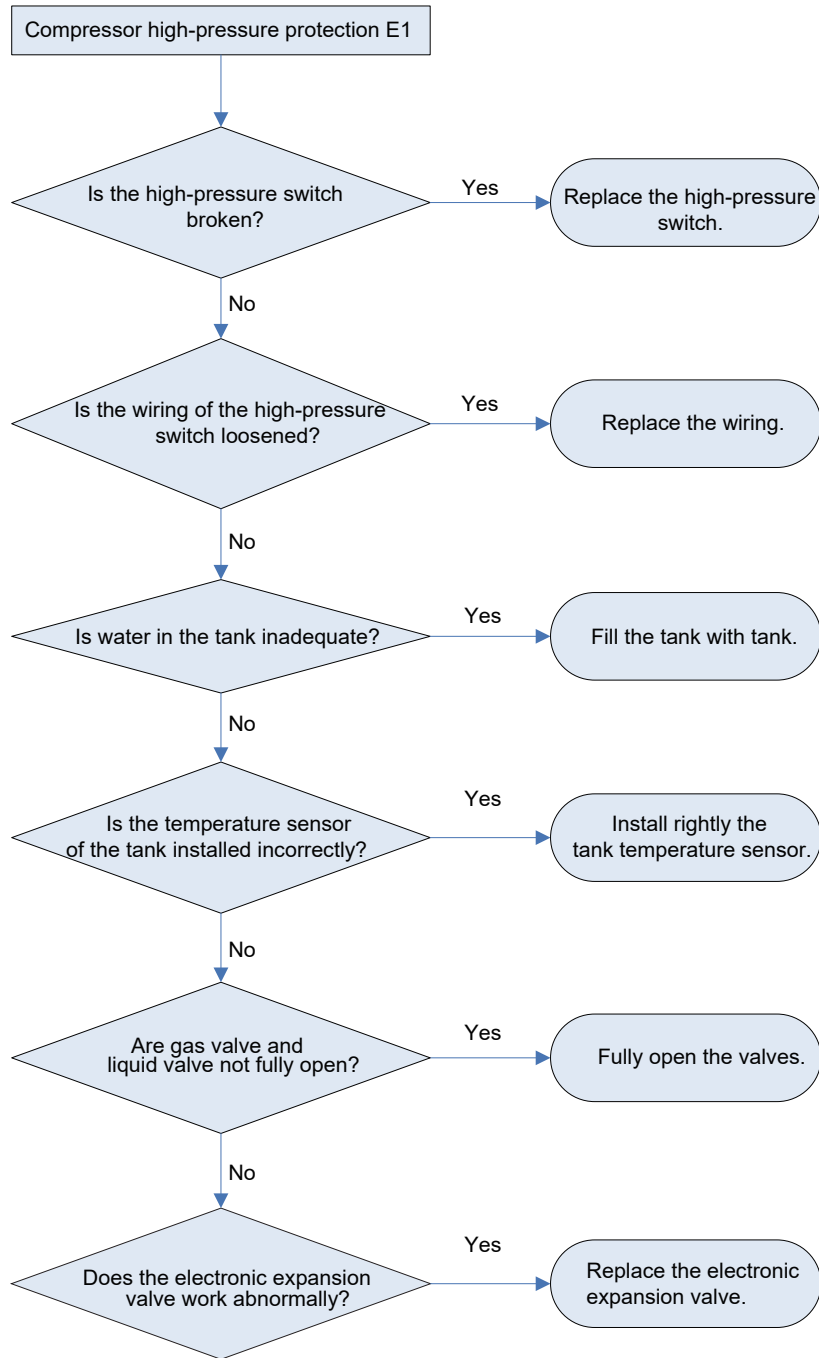

(2) Comp Low- pressure protection E3

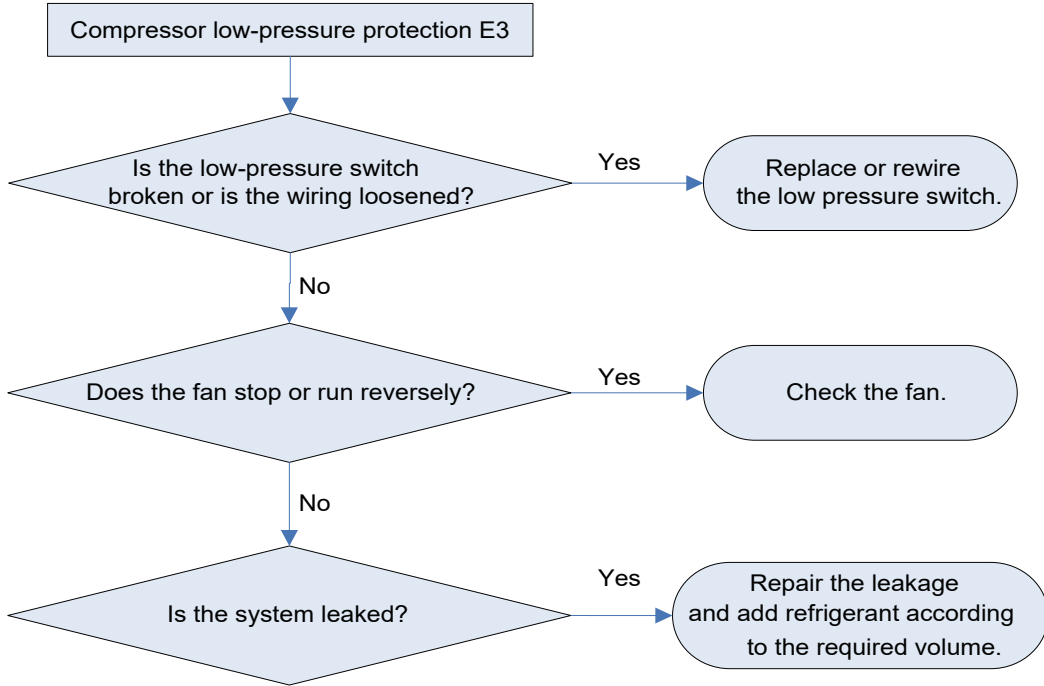

(3) Comp discharge temp protection E4

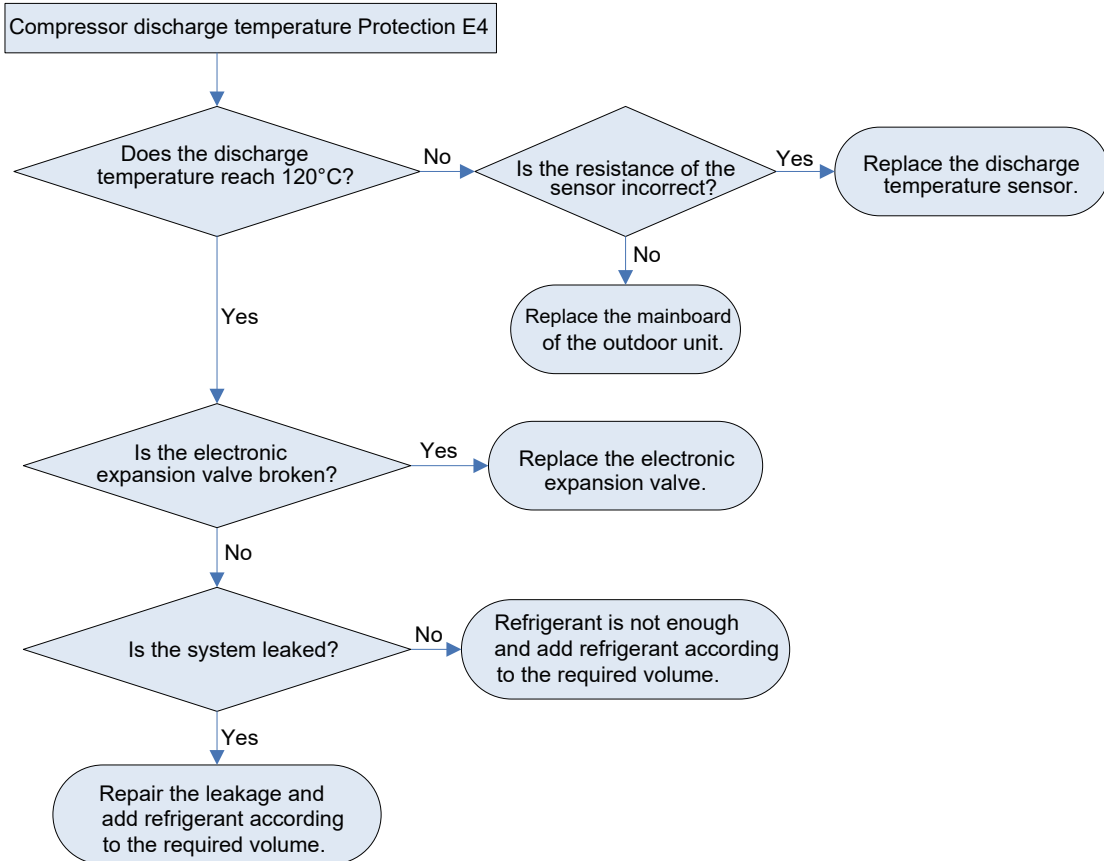

(4) Outdoor fan error EH

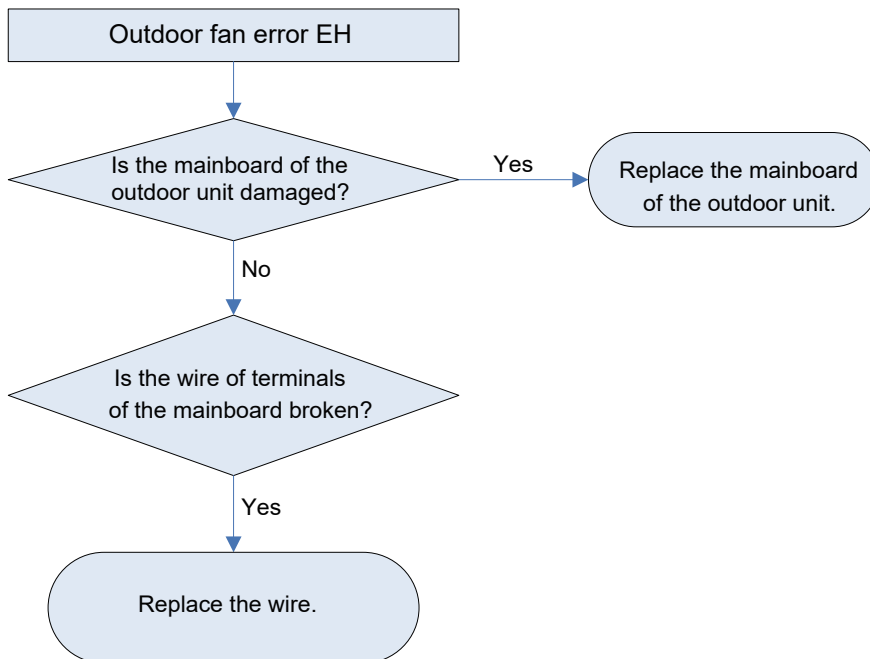

(5) Temperature sensor error

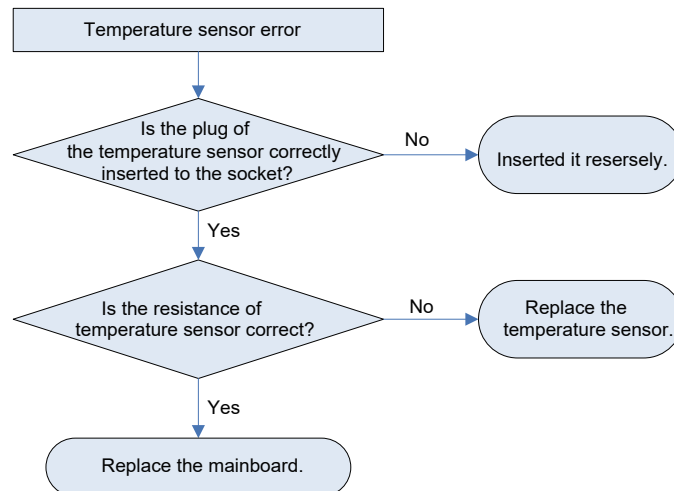

(6) Communication malfunction E6

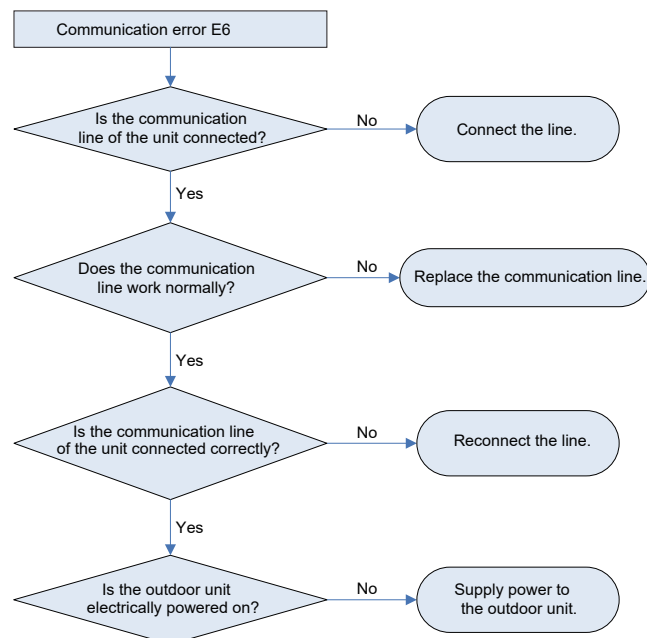

19.6.3 Diagnosis of the driving board

- (1) Overvoltage of direct current: It is detected that the voltage of direct current is over 420V after energization. If the protection occurs for 6 times within one hour, it can not be resumed unless it is deenergized and reenergized.
- (2) Under-voltage of direct current: It is detected that the voltage of direct current is lower than 200V after startup of the unit. If the protection occurs for 6 times within one hour, it can not be resumed unless it is deenergized and reenergized.
- (3) PFC abnormality: The protection against PFC abnormality is detected after the PFC works for 10s. If the protection occurs for 6 times within one hour, it can not be resumed unless it is deenergized and reenergized.
- (4) IPM protection of driving board: The protection against IPM abnormality is detected after the IPM works for 10s. If the protection occurs for 6 times within one hour, it can not be resumed unless it is deenergized and reenergized.
- (5) Overcurrent protection of compressor: The protection occurs when the instantaneous current is detected over 45A. If the protection occurs for 6 times within one hour, it can not be resumed unless it is deenergized and reenergized.
- (6) Superheat protection of IPM driving board: The protection occurs when the internal temperature of IPM

is detected higher than 105°C. If the protection occurs for 6 times within one hour, it can not be resumed unless it is deenergized and reenergized.

- (7) Abnormal sensor of radiating fin: The protection occurs when break circuit or short circuit of the temperature sensor on top of the IPM module. If the protection occurs for 6 times within one hour, it can not be resumed unless it is deenergized and reenergized.
- (8) Communication error of conversion driver and main controller: the driving board can not communicate with the main controller normally. This error can be resumed automatically.

19.6.4 Diagnosis flowchart of the driving board

(1) PFC abnormality

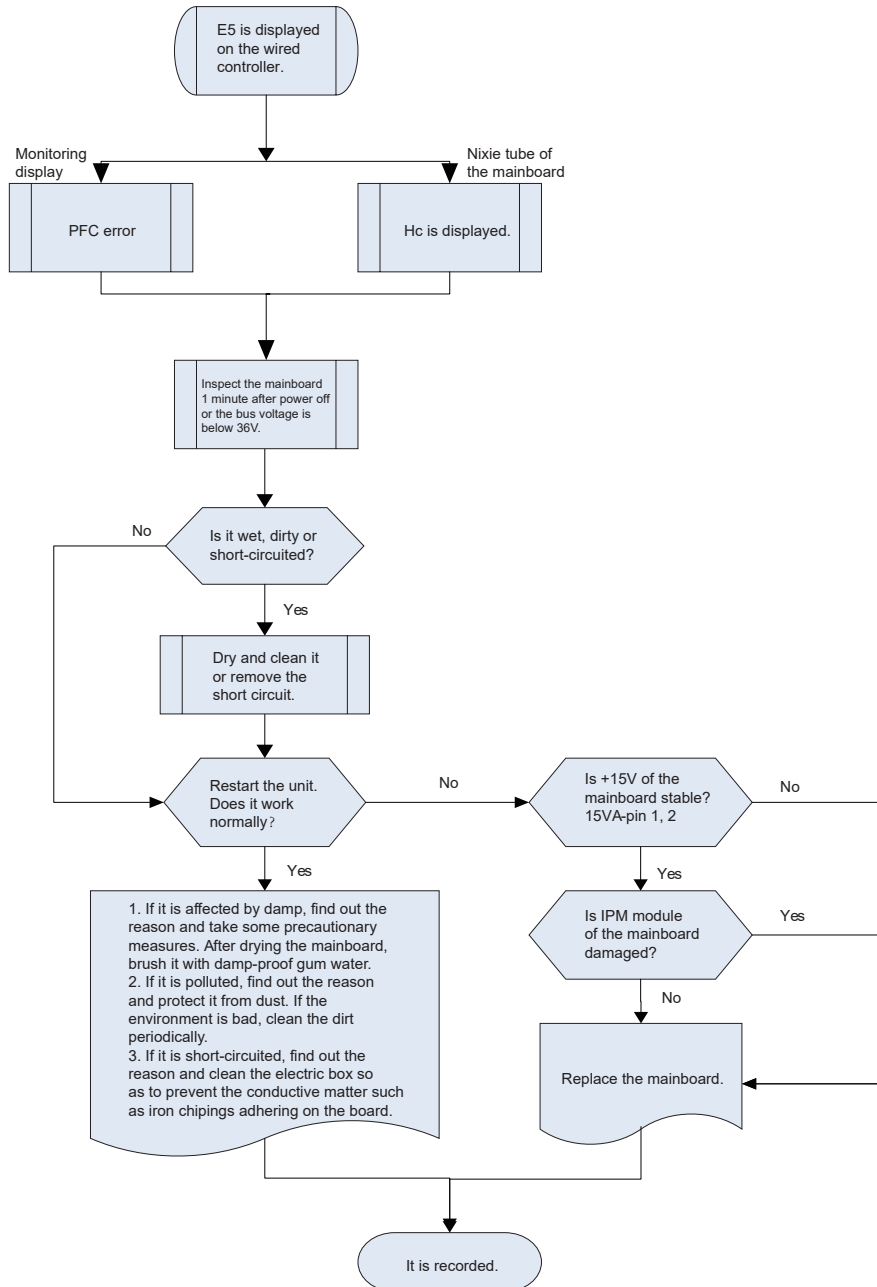

(2) IPM protection

The reasons may be:

- Untight screws of IPM module
- damaged IPM module
- defective radiating of IPM module
- abnormal +15V power strip
- abnormal PFC module
- wire connection error with PFC
- wrong cement resistance RS1-RS3 of driving board
- abnormal compressor
- interference

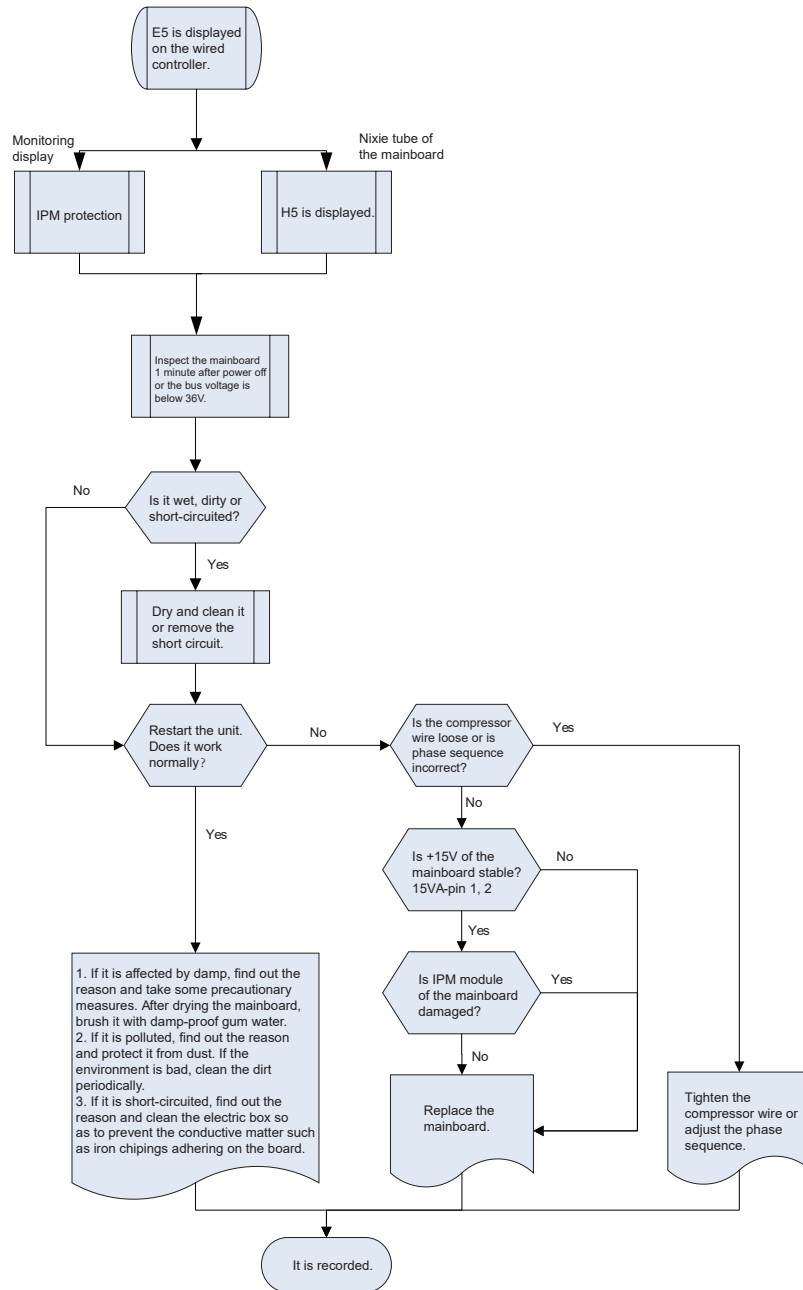

(3) Trip

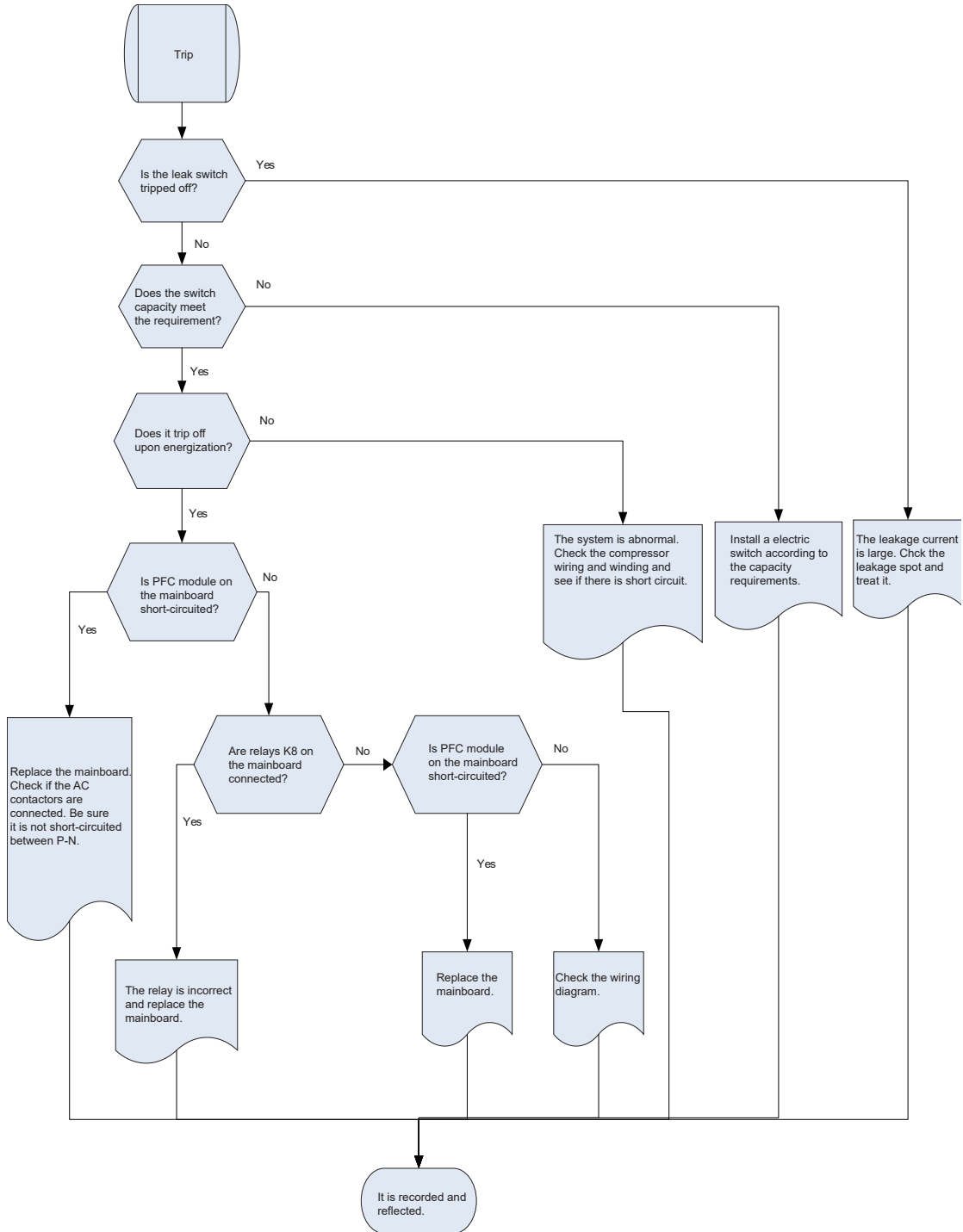

(4) Abnormal Noise of PFC Inductor

Generally, the continuous and minute sound of inductor is normal. Abnormal noise of PFC inductor refers to discontinuous and obvious noise. The reasons may be:

- PFC malfunction
- abnormal output of driving board

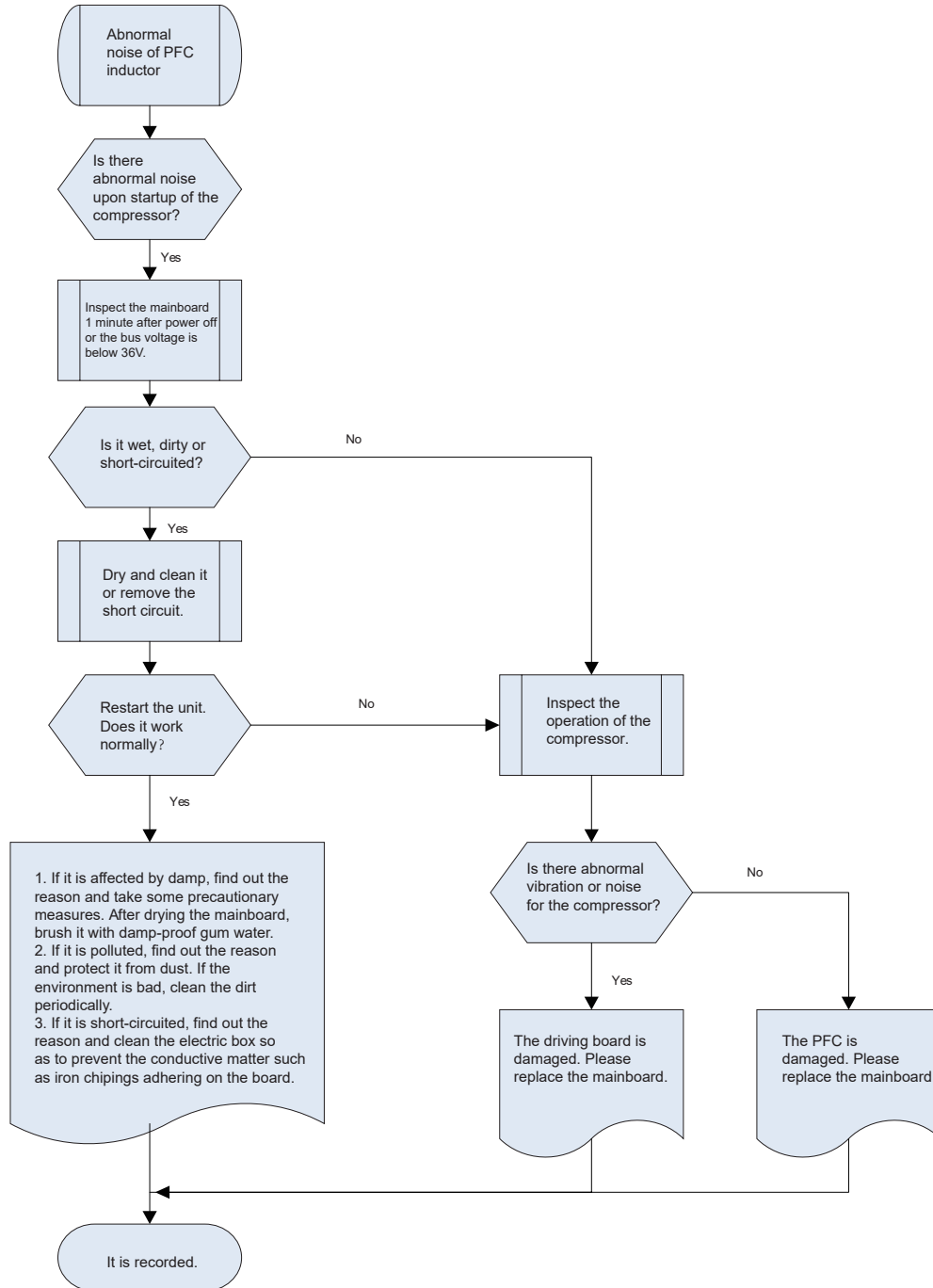

(5) Over-temperature Protection of Radiating Fin

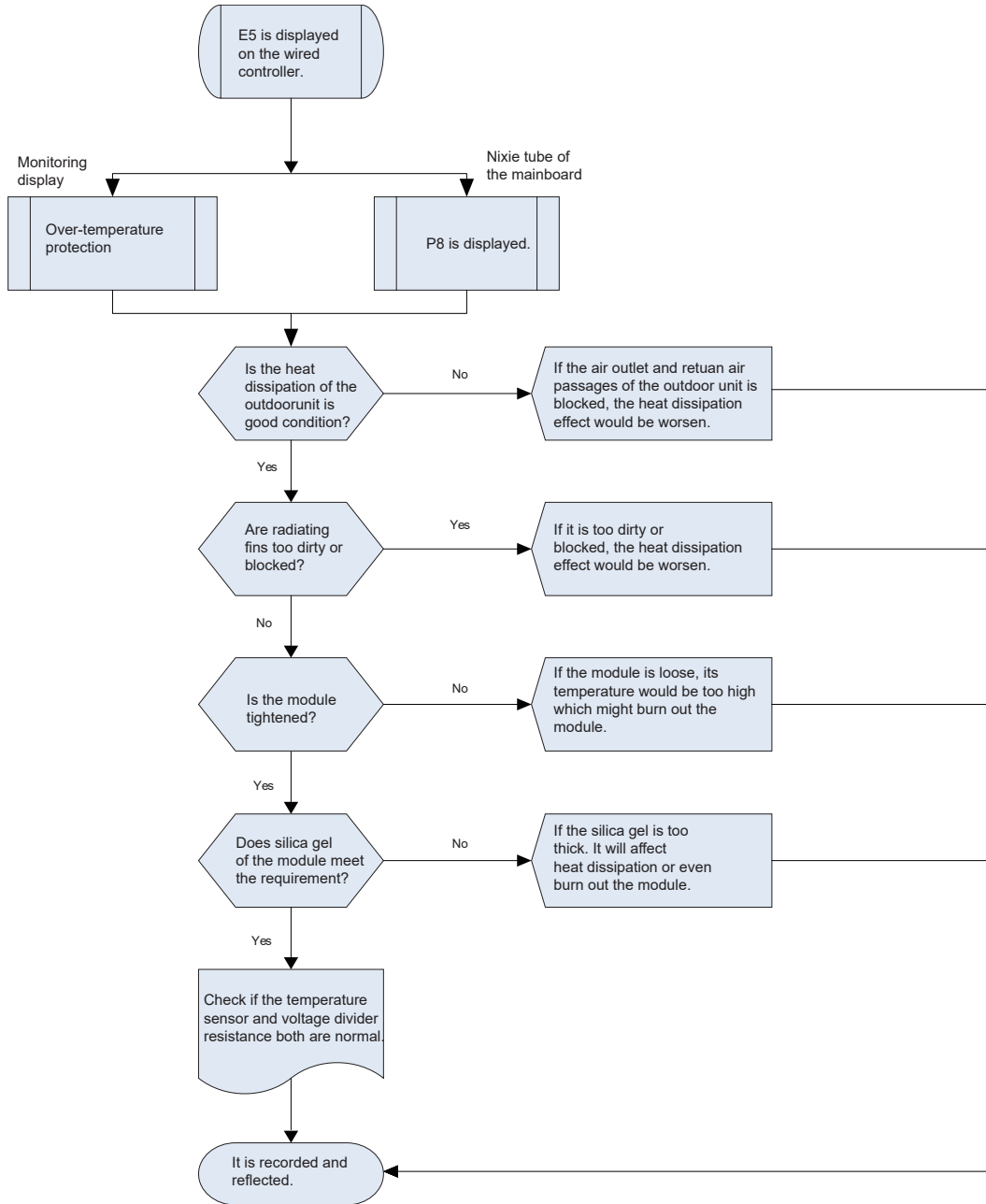

(6) Overvoltage protection of DC bus

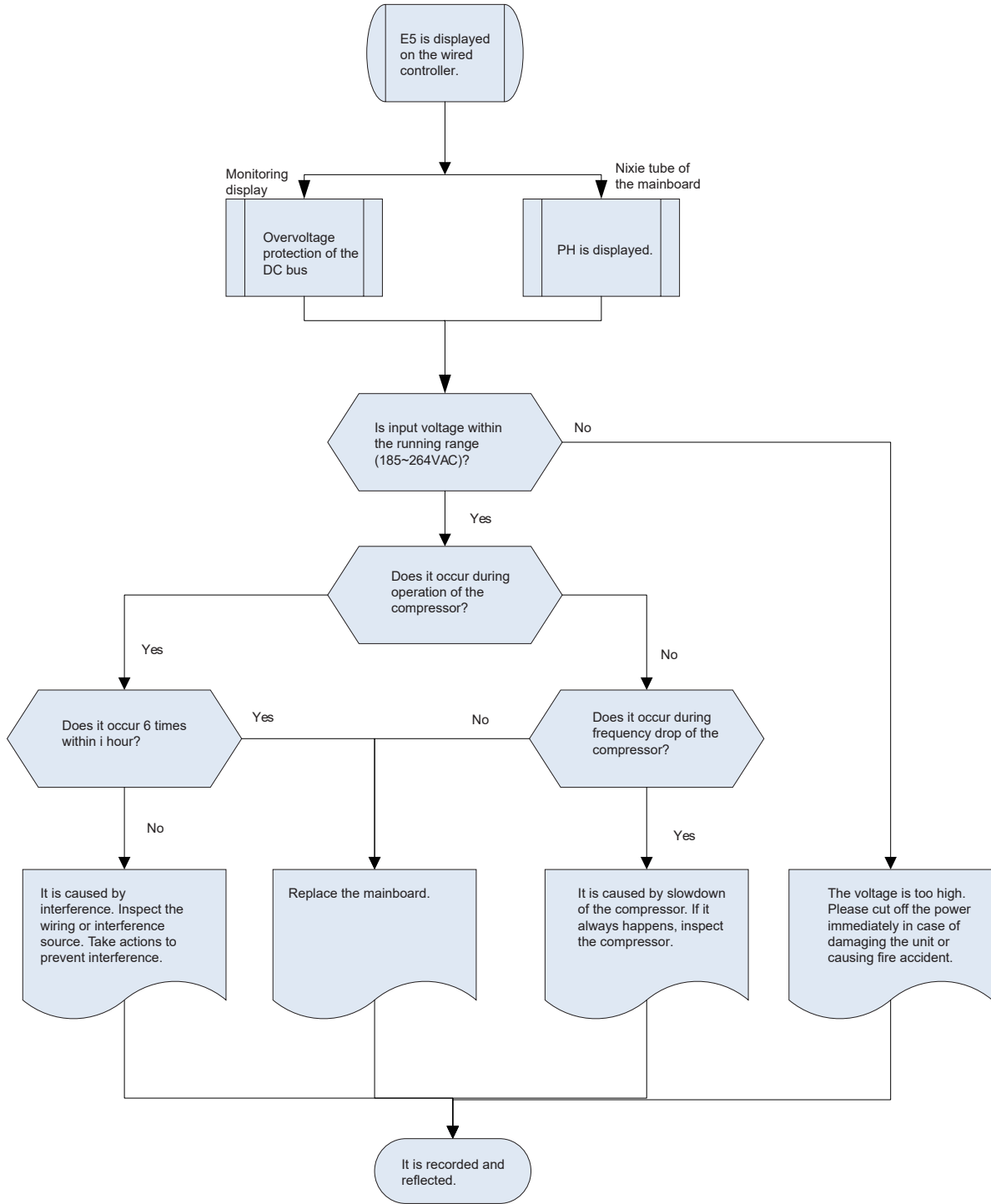

(7) Under-voltage Protection of DC bus

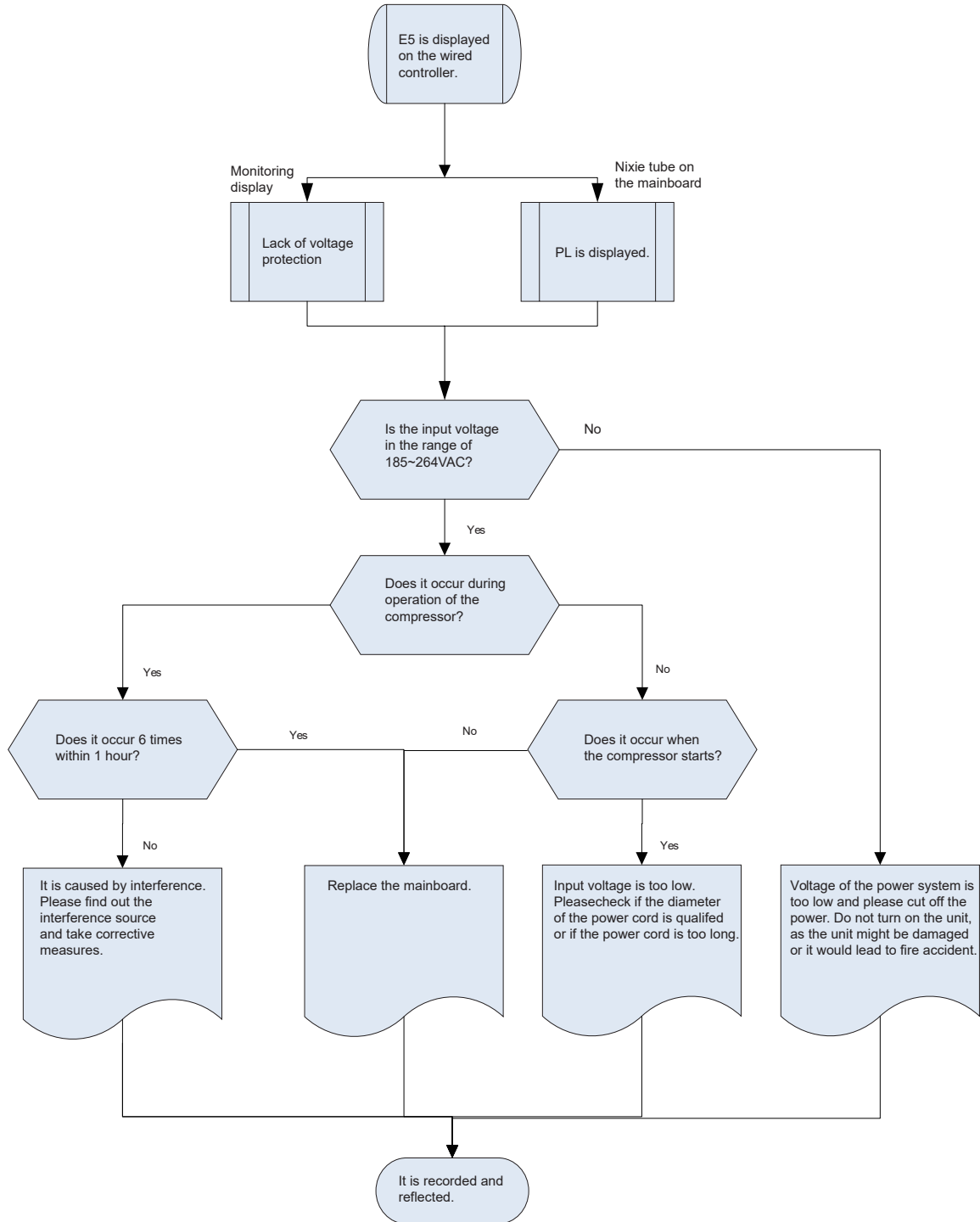

19.6.5 Disassembly of the unit

Operation Procedure	Illustration
<p>Note: firstly please cut off the power supply and discharge refrigerant out of the unit.</p> <p>GRS-CQ8.0Pd/NhG3-E, GRS-CQ10Pd/NhG3-E, GRS-CQ12Pd/NhG3-E, GRS-CQ14Pd/NhG3-E, GRS-CQ16Pd/NhG3-E GRS-CQ8.0Pd/NhG4-E, GRS-CQ10Pd/NhG4-E, GRS-CQ12Pd/NhG4-E, GRS-CQ14Pd/NhG4-E, GRS-CQ16Pd/NhG4-E GRS-CQ8.0Pd/NhG3-M, GRS-CQ10Pd/NhG3-M, GRS-CQ12Pd/NhG3-M, GRS-CQ14Pd/NhG3-M, GRS-CQ16Pd/NhG3-M GRS-CQ8.0Pd/NhG4-M, GRS-CQ10Pd/NhG4-M, GRS-CQ12Pd/NhG4-M, GRS-CQ14Pd/NhG4-M, GRS-CQ16Pd/NhG4-M</p>	
<p>Remove the top panel, front panel and right panel.</p>	
<p>Remove the fixing nuts and then the rear panel, connection panel and upright frame. Remove the fixing nuts and then the front grille.</p>	

Note: firstly please cut off the power supply and discharge refrigerant out of the unit.

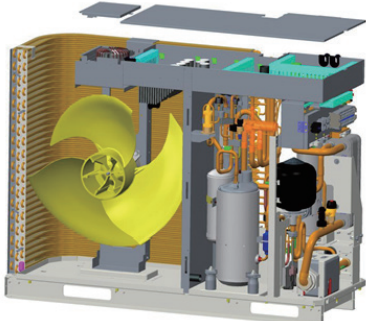
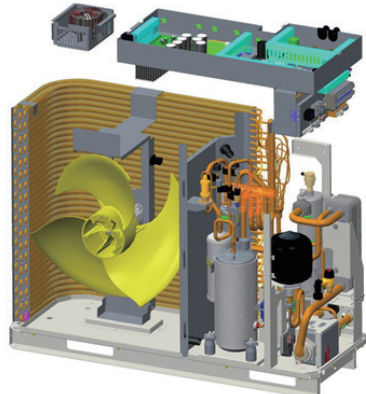
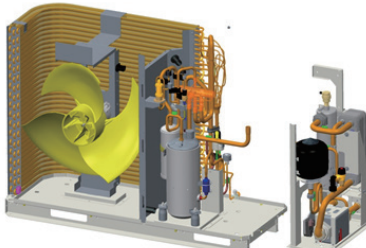
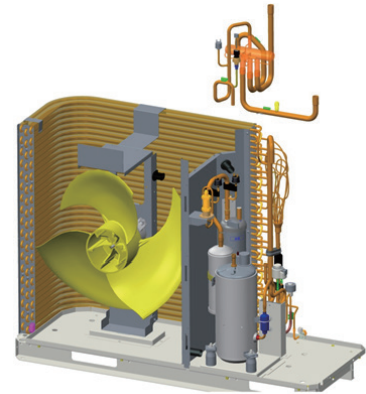
Operation Procedure	Illustration
<p>GRS-CQ8.0Pd/NhG3-E, GRS-CQ10Pd/NhG3-E, GRS-CQ12Pd/NhG3-E, GRS-CQ14Pd/NhG3-E, GRS-CQ16Pd/NhG3-E GRS-CQ8.0Pd/NhG4-E, GRS-CQ10Pd/NhG4-E, GRS-CQ12Pd/NhG4-E, GRS-CQ14Pd/NhG4-E, GRS-CQ16Pd/NhG4-E GRS-CQ8.0Pd/NhG3-M, GRS-CQ10Pd/NhG3-M, GRS-CQ12Pd/NhG3-M, GRS-CQ14Pd/NhG3-M, GRS-CQ16Pd/NhG3-M GRS-CQ8.0Pd/NhG4-M, GRS-CQ10Pd/NhG4-M, GRS-CQ12Pd/NhG4-M, GRS-CQ14Pd/NhG4-M, GRS-CQ16Pd/NhG4-M</p>	
<p>Remove the cover of both the electric box and the inductance box.</p>	
<p>Remove the electric box and the inductance box.</p>	
<p>Remove fastening bolts, desolder the joints between the plate heat exchanger gas/liquid pipe and the refrigerant system, and then remove the water system. (when desoldering the connection joint, pay attention to covering the solder joints with a damp cloth to avoid high temperature damage).</p>	
<p>Remove the 4-way valve.</p> <ul style="list-style-type: none"> • Loosen the screws fixing the coil of 4-way valve • Remove the coil of 4-way valve • Unsolder the tubes connected to the 4-way valve. • Remove the 4-way valve. • Note:when desoldering the connection joint, pay attention to covering the solder joints with a damp cloth to avoid high temperature damage. 	

Note: firstly please cut off the power supply and discharge refrigerant out of the unit.

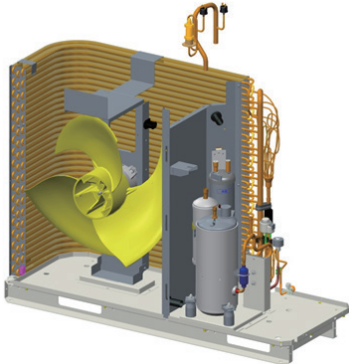
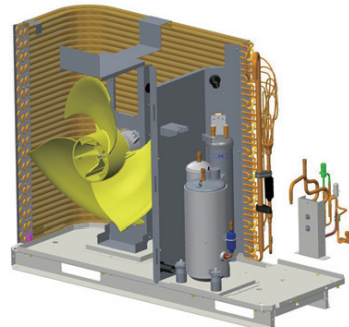
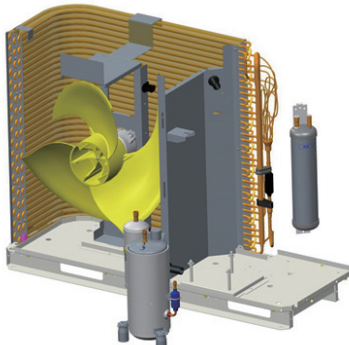
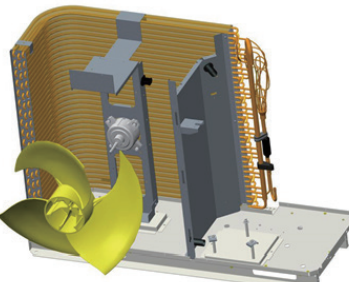
Operation Procedure	Illustration
<p>GRS-CQ8.0Pd/NhG3-E, GRS-CQ10Pd/NhG3-E, GRS-CQ12Pd/NhG3-E, GRS-CQ14Pd/NhG3-E, GRS-CQ16Pd/NhG3-E GRS-CQ8.0Pd/NhG4-E, GRS-CQ10Pd/NhG4-E, GRS-CQ12Pd/NhG4-E, GRS-CQ14Pd/NhG4-E, GRS-CQ16Pd/NhG4-E GRS-CQ8.0Pd/NhG3-M, GRS-CQ10Pd/NhG3-M, GRS-CQ12Pd/NhG3-M, GRS-CQ14Pd/NhG3-M, GRS-CQ16Pd/NhG3-M GRS-CQ8.0Pd/NhG4-M, GRS-CQ10Pd/NhG4-M, GRS-CQ12Pd/NhG4-M, GRS-CQ14Pd/NhG4-M, GRS-CQ16Pd/NhG4-M</p> <p>Remove the suction line</p> <ul style="list-style-type: none"> • Loosen the bolts fixing the gas valve. • desolder the line connected to the gas valve. • Note:when desoldering the connection joint, pay attention to covering the solder joints with a wet cloth to avoid high temperature damage. 	
<p>Remove the economizer</p> <ul style="list-style-type: none"> • Loosen the bolts fixing the . • Unsolder the pipe connected to the liquid valve. • Note:when desoldering the connection joint, pay attention to covering the solder joints with a damp cloth to avoid high temperature damage. 	
<p>Remove compressor and gas-liquid separator</p> <ul style="list-style-type: none"> • Remove the connection wire of compressor. • Unsolder the suction pipe and discharge pipe. • Loosen the bolts fixing the compressor and remove the compressor and gas-liquid separator. 	
<p>Remove the fitting bolts and the fan.</p>	

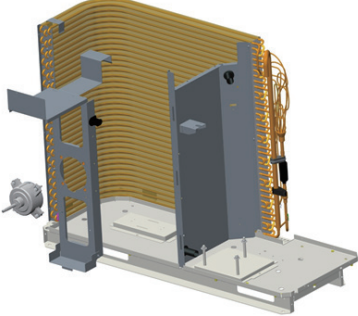
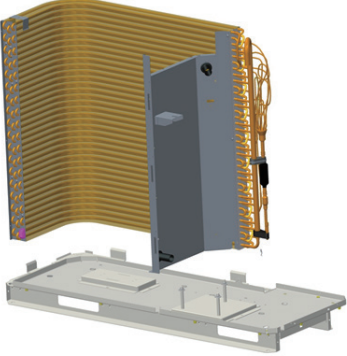
Note: firstly please cut off the power supply and discharge refrigerant out of the unit.	
Operation Procedure	Illustration
GRS-CQ8.0Pd/NhG3-E, GRS-CQ10Pd/NhG3-E, GRS-CQ12Pd/NhG3-E, GRS-CQ14Pd/NhG3-E, GRS-CQ16Pd/NhG3-E GRS-CQ8.0Pd/NhG4-E, GRS-CQ10Pd/NhG4-E, GRS-CQ12Pd/NhG4-E, GRS-CQ14Pd/NhG4-E, GRS-CQ16Pd/NhG4-E GRS-CQ8.0Pd/NhG3-M, GRS-CQ10Pd/NhG3-M, GRS-CQ12Pd/NhG3-M, GRS-CQ14Pd/NhG3-M, GRS-CQ16Pd/NhG3-M GRS-CQ8.0Pd/NhG4-M, GRS-CQ10Pd/NhG4-M, GRS-CQ12Pd/NhG4-M, GRS-CQ14Pd/NhG4-M, GRS-CQ16Pd/NhG4-M	
Remove the fixing bolts at the motor and fitting nuts at the motor support, and then remove the motor and the motor support.	
Separate the condenser from the base by removing fixing bolts at them.	

Note: firstly please cut off the power supply and discharge refrigerant out of the unit.	
Operation Procedure	Illustration
GRS-CQ4.0Pd/NhG3-E, GRS-CQ6.0Pd/NhG3-E, GRS-CQ4.0Pd/NhG4-E, GRS-CQ6.0Pd/NhG4-E	
Remove the fixing bolts, top cover, front panel and right panel.	

Note: firstly please cut off the power supply and discharge refrigerant out of the unit.

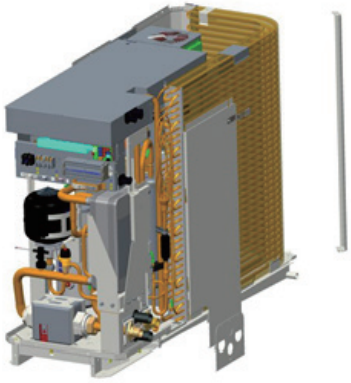
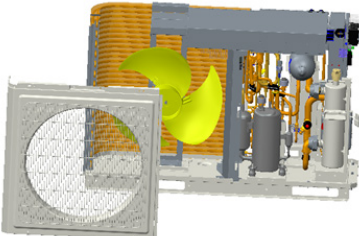
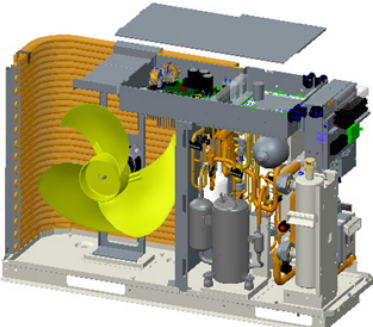
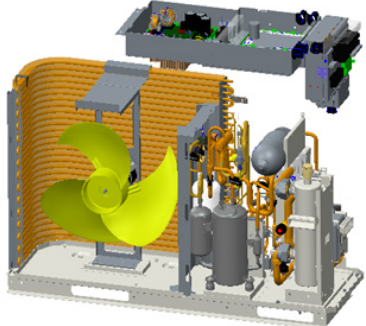
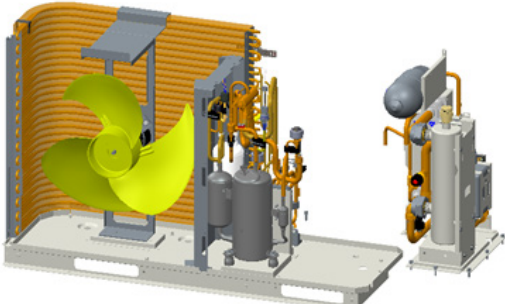
Operation Procedure	Illustration
GRS-CQ4.0Pd/NhG3-E, GRS-CQ6.0Pd/NhG3-E, GRS-CQ4.0Pd/NhG4-E, GRS-CQ6.0Pd/NhG4-E	
<p>Remove the fixing bolts, real panel, connector panel, support (upright column).</p>	
<p>Remove the fixing bolts and outer guard.</p>	
<p>Remove the fixing bolts and cover of the electric box.</p>	
<p>Remove the fixing bolts and electric box.</p>	
<p>Remove fixing bolts, desolder connection points between gas/liquid lines of the plate-type heat exchanger and the main unit, and then remove the water system. Note:when desoldering the connection joint, pay attention to covering the solder joints with a wet cloth to avoid high temperature damage.</p>	

Note: firstly please cut off the power supply and discharge refrigerant out of the unit.

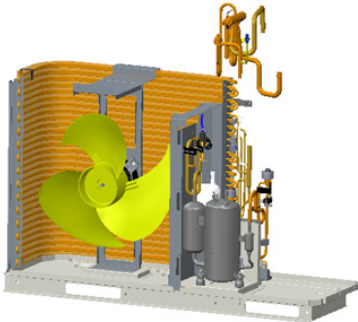
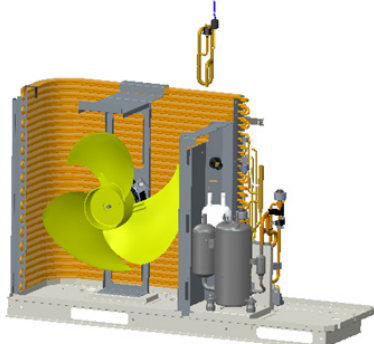
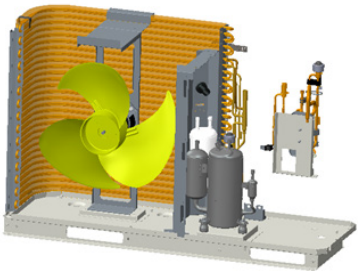
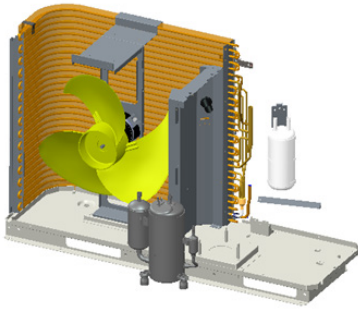
Operation Procedure	Illustration
<p>GRS-CQ4.0Pd/NhG3-E, GRS-CQ6.0Pd/NhG3-E, GRS-CQ4.0Pd/NhG4-E, GRS-CQ6.0Pd/NhG4-E</p> <p>Desolder connection points of the 4-way valve, and remove the pipelines of the 4-way valve. Note:when desoldering the connection joint, pay attention to covering the solder joints with a wet cloth to avoid high temperature damage.</p>	
<p>Desolder connection points of the suction lines and remove suction lines. Note:when desoldering the connection joint, pay attention to covering the solder joints with a wet cloth to avoid high temperature damage.</p>	
<p>Desolder connection points of the economizer, remove fixing bolts and then remove the economize. Note:when desoldering the connection joint, pay attention to covering the solder joints with a wet cloth to avoid high temperature damage.</p>	
<p>Remove fixing bolts of the compressor and the gas-liquid separator, and then remove the compressor and the gas-liquid separator.</p>	

Note: firstly please cut off the power supply and discharge refrigerant out of the unit.

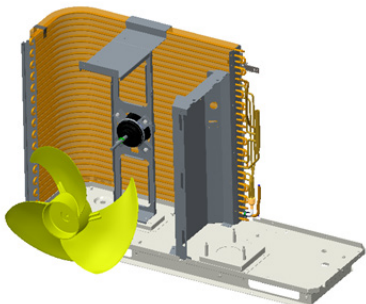
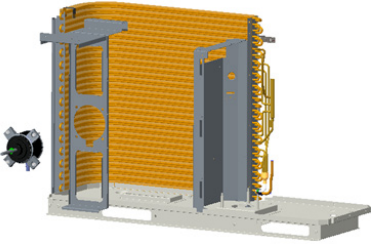
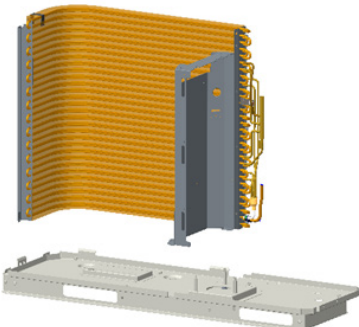
Operation Procedure	Illustration
GRS-CQ4.0Pd/NhG3-E, GRS-CQ6.0Pd/NhG3-E, GRS-CQ4.0Pd/NhG4-E, GRS-CQ6.0Pd/NhG4-E	
<p>Remove fixing bolts and then the fan.</p>	
<p>Remove fixing bolts of the motor and the motor support and then move them.</p>	
<p>Remove fixing bolts, and then separate the condenser from the base.</p>	

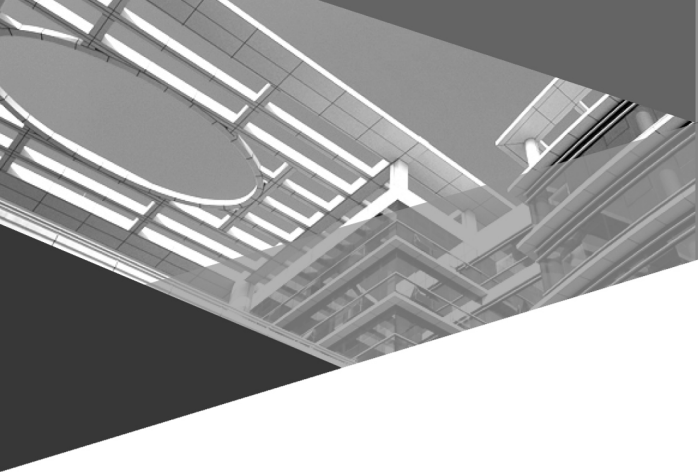

GREE ELECTRIC APPLIANCES, INC. OF ZHUHAI

Add: West Jinji Rd, Qianshan, Zhuhai,Guangdong, China, 519070

Tel: (+86-756) 8522218

Fax: (+86-756) 8669426

E-mail: global@cn.gree.com www.gree.com



600005063520