



Smart Zone Controller

Installation Manual



Commercial Air Conditioners

- Thank you for choosing Commercial Air Conditioners, please read this owner's manual carefully before operation and retain it for future reference.
- GREE reserves the right to interpret this manual which will be subject to any change due to product improvement without further notice.
- GREE Electric Appliances, Inc. of Zhuhai reserves the final right to interpret this manual.

CONTENTS

1 Safety Precautions	1
2 General Introduction.....	2
2.1 Function Introduction.....	2
2.2 Communication Network	3
3 LCD	4
3.1 Outline of the LCD.....	4
3.2 Introduction to Symbols on the LCD.....	4
4 Buttons	5
4.1 Outline of Buttons.....	5
4.2 Introduction to the Function of Buttons.....	6
5 Installation and Debugging.....	7
5.1 Installation	7
5.2 Unit Matching	10
5.3 Debugging and Viewing the Port No. and the Indoor Unit Address.....	11
5.4 Labeling.....	12
6 Control Flow Chart.....	13
7 Viewing of the Running Status of the Indoor Unit and Control Mode	13
7.1 Viewing of the Running Status of the Indoor Unit.....	13
7.2 Control Mode.....	14
7.3 Control Setting.....	16
8 Error Display.....	34

1 Safety Precautions

 WARNING!	<p>This mark indicates procedures which, if improperly performed, might lead to the death or serious injury of the user.</p>
 CAUTION!	<p>This mark indicates procedures which, if improperly performed, might possibly result in personal harm to the user, or damage to property.</p>

 WARNING!	
<p>① .</p>	<p>For operating the air conditioner pleasantly, install it as outlined in this installation manual.</p>
<p>② .</p>	<p>Connect the indoor unit and outdoor unit with the room air conditioner piping and cord available from our standard parts. This installation manual describes the correct connections using the installation set available from our standard parts.</p>
<p>③ .</p>	<p>Installation work must be performed in accordance with national wiring standards by authorized personnel only.</p>
<p>④ .</p>	<p>If refrigerant leaks while work is being carried out, ventilate the area. If the refrigerant comes in contact with a flame, it produces toxic gas.</p>
<p>⑤ .</p>	<p>Do not power on until all installation work is complete.</p>
<p>⑥ .</p>	<p>During installation, make sure that the refrigerant pipe is attached firmly before you run the compressor. Do not operate the compressor under the condition of refrigerant piping not attached properly with 2-way or 3-way valve open. This may cause abnormal pressure in the refrigeration cycle that leads to breakage and even injury.</p>
<p>⑦ .</p>	<p>During the pump-down operation, make sure that the compressor is turned off before you remove the refrigerant piping. Do not remove the connection pipe while the compressor is in operation with 2-way or 3-way valve open. This may cause abnormal pressure in the refrigerant cycle that leads to breakage and even injury.</p>
<p>⑧ .</p>	<p>When installing and relocating the air conditioner, do not mix gases other than the specified refrigerant (R410A) to enter the refrigerant cycle. If air or other gas enters the refrigerant cycle, the pressure inside the cycle will rise to an abnormally high value and cause breakage, injury, etc.</p>

2 General Introduction

2.1 Function Introduction

This smart zone controller is intended for VRF, free-match and ducttype unit, capable of controlling up to 3 sets of multi VRF units and multi sets of duct type/ free match units with maximum 16 indoor units.

Through this smart zone controller, it is available to view and control those running parameters of the indoor unit, including on/off, running mode, fan speed etc, and also perform the single control and centralized control, further, it also can set the weekly timer and long-distance shielding to realize convenient control to the air conditioning system.

a. Single control: it is intended to control the running parameters of a designated indoor unit individually.

b. Centralized control: it is intended to control the running parameters of all indoor units at the same time.

c. Shielding under single or centralized control: it is intended to shield the running parameter of the indoor unit.

d. Weekly timer under single or centralized control: it is intended to set when to start/stop the unit through long-distance control.

e. Clock: it is intended to set and display the weekday, hour and minute.

After the debugging to the controller is finished, it can check the on-line indoor units and display the parameter setting of the current running mode, set temperature, fan speed, weekly timer, shielding function etc. When some error occurs, the error symbol and the error code will be displayed to warn a quick maintenance.

This smart zone controller can be connected to the unit through the communication line without the need of the communication module, which can extremely ease and simplify the installation.

This smart zone controller can be integrated with the long-distance monitoring system and the centralized controller (it indicates the controller that should be equipped with the communication module) and the control of the long-distance monitoring system and the centralized controller takes priority over that of the smart zone controller.

2.2 Communication Network

2.2.1 Units Connection

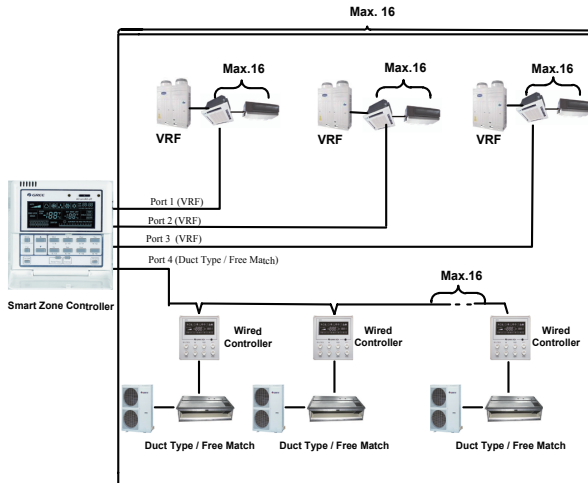

Fig.2.1 Unit Connection Diagram

Note: the smart zone controller can connect with maximum three sets of multi VRF units and multiple duct type units, however, the total of the indoor units of all four ports can not exceed 16.

2.2.2 Integration of the Smart Zone Controller and Long-distance Monitoring System/ Centralized Controller

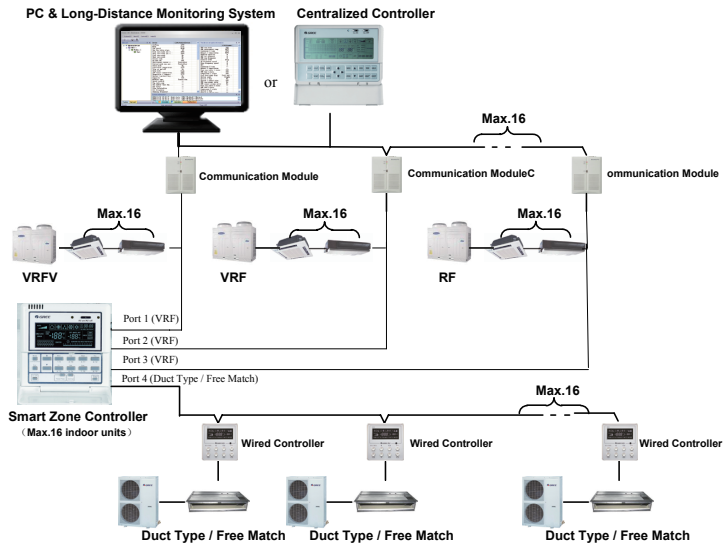

Fig.2.2 Connection of the Smart Zone Controller and the Long-distance Monitoring System/ Centralized Controller

Notes:

- ① . Only the multi VRF units can be integrated with the long-distance monitoring system/ centralized controller.
- ② . When the shielding function has been set neither for the smart zone controller nor for the long-distance monitoring system/the centralized controller, the smart zone controller can fully be compatible with the long-distance monitoring system/the centralized controller with its control inferior to that of the latter ones.
- ③ . When the shielding function has been set for both the smart zone controller and the long-distance monitoring system/the centralized controller, the smart zone controller can only be used to view the status of the unit and its control function goes ineffective.

3 LCD

3.1 Outline of the LCD

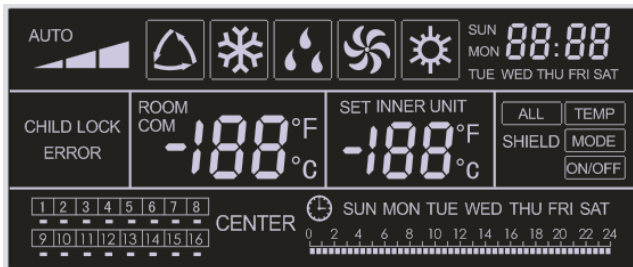

Fig.3.1 Outline of the LCD

3.2 Introduction to Symbols on the LCD



Fig.3.2 Introduction to Symbols on the LCD

Table 3.1: Introduction to the Symbols on the LCD

No.	Name	Description
1	Fan speed	It displays the fan speed of the indoor unit, high, medium, low and auto.
2	Running mode	It displays the running mode of the indoor unit, auto, cool, dry, fan and heat.
3	System clock	It displays the current time (hour and minute) in 24-hour time system and also the week day.
4	Shield	It displays the shielded status, "ALL", "TEMP", "MODE" and "ON/OFF".
5	Weekly timer	It displays the timing period (unit: 0.5 hour) which will circulate every week.
6	Set temperature Indoor unit code	It displays the set temperature, indoor unit code (01-16), and symbols of Celsius and Fahrenheit scale.
7	Control mode	It displays "CENTER" under the centralized control mode and no display under the single control mode.
8	Ambient temperature Serial port	It displays the ambient temperature, serial port as well as symbols of Celsius and Fahrenheit scale.
9	Indoor unit code On/off status	Numbers indicate the indoor unit codes which will be displayed when the corresponding indoor unit is online; "□" indicates the on/off status of the indoor unit, that is, when it is bright, it means the unit is "On"; when it is gone out, it means the unit is "Off".
10	Error Child lock	It displays the error codes when some error(s) arises and also "CHILD LOCK" when this function is activated.

4 Buttons

4.1 Outline of Buttons

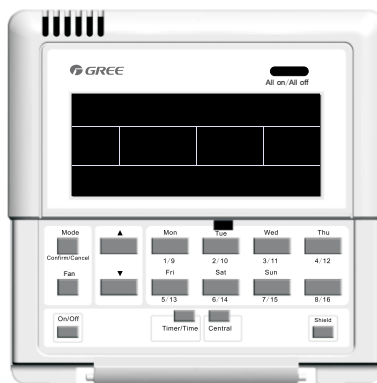

Fig.4.1 Outline of Buttons

4.2 Introduction to the Function of Buttons

Table 4.1 Functions of Buttons

No.	Name	Function Description
1	Mode	It is used for the switchover among different modes
2	Fan	It is used to set the fan speed, high, medium, low or auto.
3	On/Off	It is used to set the on/off status of the indoor unit.
4	▲	1. Under the single/centralized control status:It is used to set the running temperature of the indoor unit with max.30℃ and min.16℃ . 2. Under the timing setting status:It is used to set the timing period with max.24 hours and min.0 hour. 3. Under the clock setting status: it is used to set the hour (max.:23, min.: 0) and minute (max.:59, min.: 0) of the clock.
5	▼	
6	Mon 1/9	It is used for the switchover between unit 1 and unit 9; Under the timing or clock setting status, it indicates Monday.
7	Tue 2/10	It is used for the switchover between unit 2 and unit 10; Under the timing or clock setting status, it indicates Tuesday.
8	Wed 3/11	It is used for the switchover between unit 3 and unit 11 Under the timing or clock setting status, it indicates Wednesday.
9	Thu 4/12	It is used for the switchover between unit 4 and unit 12 Under the timing or clock setting status, it indicates Thursday.
10	Fri 5/13	It is used for the switchover between unit 5 and unit 13 Under the timing or clock setting status, it indicates Friday.
11	Sat 6/14	It is used for the switchover between unit 6 and unit 14; Under the timing or clock setting status, it indicates Saturday.
12	Sun 7/15	It is used for the switchover between unit 7 and unit 15 Under the timing or clock setting status, it indicates Sunday.
13	8/16	It is used for the switchover between unit 8 and unit 16
14	Timer/Time	It is used to set the timing or on/off time of the selected indoor unit as well as to set the clock of the system.
15	Central	It is used for the switchover between single and centralized control modes.
16	Shield	It is used to deactivate some or all functions of a single or a group the indoor unit(s).
17	All on/off	It is used to start/stop all indoor units.
18	Mode+Thu 4/12	Press them for 5s simultaneously to enter into project-adjusting status. As for first energization, or change of process setting, or change of series port, it should be adjusted again (see 4.3 for the method)

5 Installation and Debugging

5.1 Installation

5.1.1 Installation Dimension Diagram

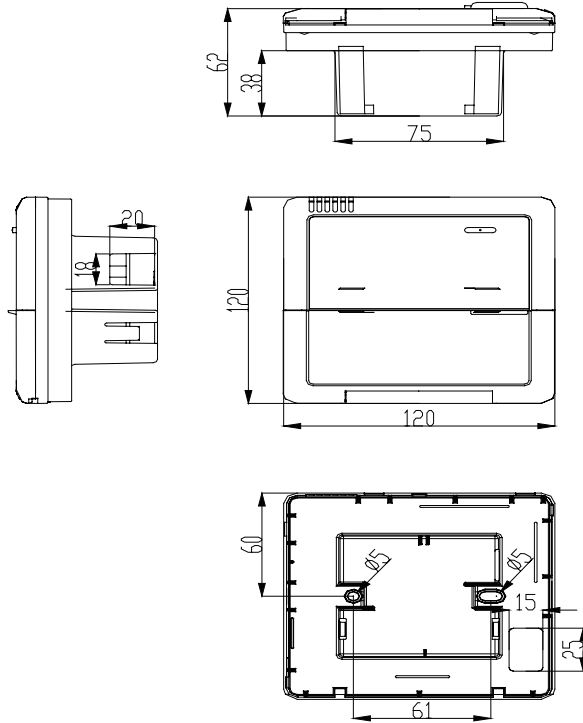

Fig.5.1 Installation Dimensions Diagram

5.1.2 Interfaces

See Fig.5.2 for the interfaces of the display board and see Fig.4.3 for the interfaces of the power supply module.

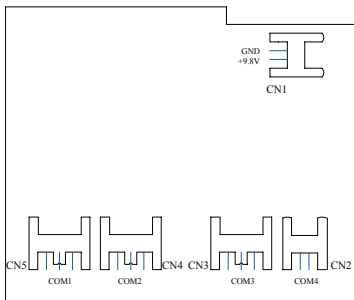

Fig.5.2 Interfaces of the Display Board

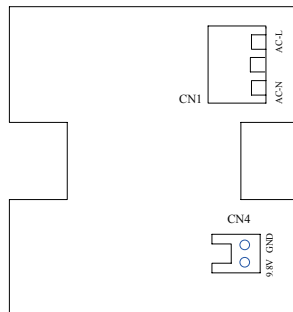

Fig.5.3 Interfaces of the Power Supply Module Board

(1) Interface of the Power Supply

a. The interface CN1 of the power supply module board is for the connection board of the external power cord, the terminal AC-N for the neutral line, the terminal AC-L for the live line and the middle terminal keeps open.

b. The interface CN4 of the power supply module board which is for the power supply of the display board, is connected with the interface CN1 of the display board through the two-core wire provided by Gree.

(2) Communication Interface

The interfaces CN2, CN3, CN4 and CN5 of the display board are for communication, and CN2 namely COM4 is for the communication of the duct type unit (2-pin); CN5, CN4, CN3 namely COM1, COM2, COM3 respectively are for the communication of the multi VRF system (3-pin).

5.1.3 Preparation and Connection of the Communication Line

a. The communication line between the centralized controller and the unit should be prepared by the user according to the actual project.

b. Preparation and connection of the communication line for the multi VRF system

① One three-core communication line is needed to connect one set of multi VRF system to one interface (COM1, COM2 or COM3) of the smart zone controller.

② One end of the communication line is connected with the smart zone controller and the other is connected with the three-pin socket of the indoor unit.

c. Preparation and connection of the communication line for the duct type unit

① The communication line for the duct type unit is the two-core line provided by Gree (one end is the two-core head and the other end is the crystal head, code: 40113325)

② Where there are N sets of duct type units, then N+1 communication lines are needed.

③ Connect the two-core head of one communication line to the port COM4 of the smart zone controller and connect the two-core heads of N communication lines to the two-pin socket of the wired controller of the duct type unit.

④ The user can prepare the extension line and connect the wires inside the crystal head according to the actual need.

Note: one set of Multi VRF system consists of one multi VRF outdoor unit and one or more than one multi VRF indoor units. And one set of duct type unit consists of one duct type outdoor unit and one duct type indoor unit.

5.1.4 Installation

The installation can proceed on when the installation location is selected and the installation steps are as follows:

a. Firstly make sure where to install the smart zone controller.

b. Embed the power supply box (2) as Fig.4.6 for the installation of the bottom case (3).

c. Connect the power cord and the communication line of the display board and then let both go through the power supply box (2).

d. Fix the bottom case on the power box (2) by screws.

e. Tidy up the power cord and the communication line inside the smart zone controller.

f. Close the cover (5)

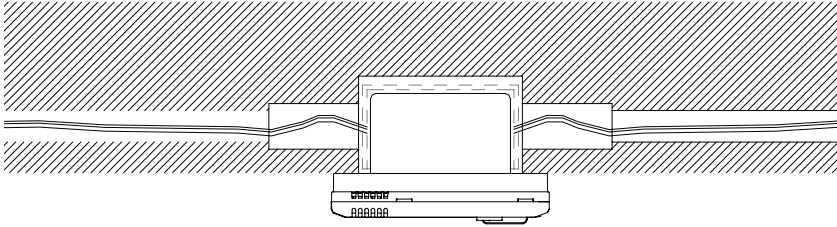

Fig.5.4 Concealed Cable Installation 1 (right-left wiring)

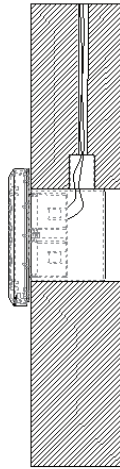

Fig.5.5 Concealed Cable Installation 2 (up-down wiring)

Note: the power cord must be separated from the communication line to avoid any interference.
Hole for the power cord

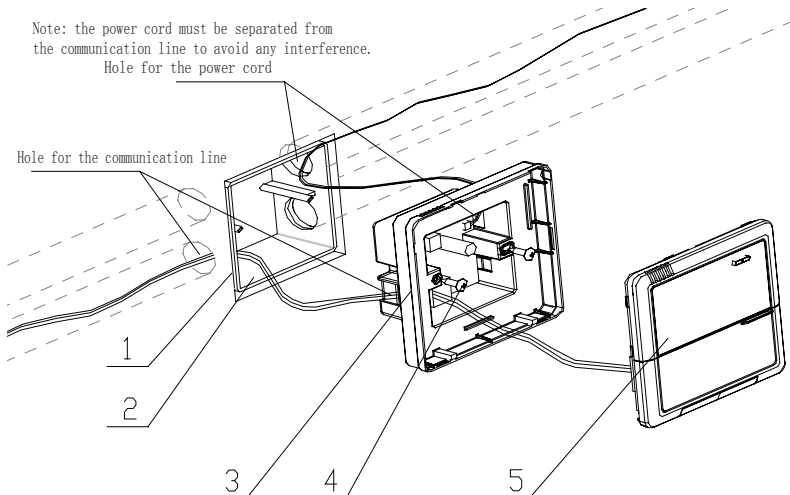

Fig. 5.6 Installation Diagram

Serial No.	Description
1	Wall
2	Power Supply Box (86)
3	Bottom Base(including power supply module board)
4	Screw
5	Top Cover(including the display board)

After the installation, it is necessary to make the debugging to guarantee the normal communication.

5.2 Unit Matching

Provided that only the multi VRF unit is needed for some project, for the outdoor unit with the connection board, one smart zone controller can control maximum 16 indoor units matched with maximum three connection boards; for the outdoor unit without the connection board, one smart zone controller can control maximum 16 indoor units of maximum three outdoor units.

Provided that only the duct type indoor unit (one outdoor unit is matched with one indoor unit) is needed for some project, one smart zone control can control up to 16 duct type indoor units

Provided that both duct type unit and the multi VRF unit are needed for some project, maximum threes ports of the smart zone controller can be connected with the multi VRF units and allowable maximum quantity of all indoor units at four ports is 16.

Example 1:

Suppose that there are three multi VRF outdoor units, 10 multi VRF indoor units, five duct type outdoor units and five duct type indoor units for some project, only one smart zone controller is needed.

Project Demand	Multi VRF System			Duct Type Unit	
	Multi VRF Outdoor Unit	Connection Board	Multi VRF	Series E Duct Type Outdoor Unit	Duct Type Indoor Unit
	GMV-R300W2/B-N2	/	/	FGR7.5/E-N3(O)	FGR7.5/E-N3(I)
Quantity(set)	3	0	10	5	5
Quantity (smart zone controller)	1				

Example 2:

Suppose that there are two GMV-R620W4/A-N1 outdoor units and 32 multi VRF indoor units, then two smart zone controllers are needed, as shown in the table below.

Project Demand	Multi VRF System		
	Outdoor Unit	Connection Board	Indoor Unit
	GMV-R620W4/A-N1	/	/
Quantity (set)	2	4	32
Quantity (smart zone controller)	2		

5.3 Debugging and Viewing the Port No. and the Indoor Unit Address

Debugging setting: In the event that the unit is initially powered on, the setting for the project changes, or the serial port is replaced, and then it is available to go to the debugging status by pressing “Mode” and “Thu” simultaneously for five seconds, under which page, it is enabled to check automatically and distribute the address of the indoor unit. 10 minutes later, the debugging is finished and the indoor unit which gains the address is under control and the unaddressed indoor unit is not.

Viewing the serial port and the indoor unit address: It is available to go to the debugging page by pressing “Mode” and “Thu” simultaneously for five seconds, under which page it is enabled to view the serial port and address of the corresponding indoor unit

The press on “Confirm/Cancel” can confirm this debugging setting and go to the viewing state of the current indoor unit; otherwise this setting will not be saved.

See Fig.5.7 for the debugging operation. Fig.5.7 shows the indoor unit 1 and indoor unit 2, both of which are connected with the port COM2. The address of one is 01 and the other is 04.

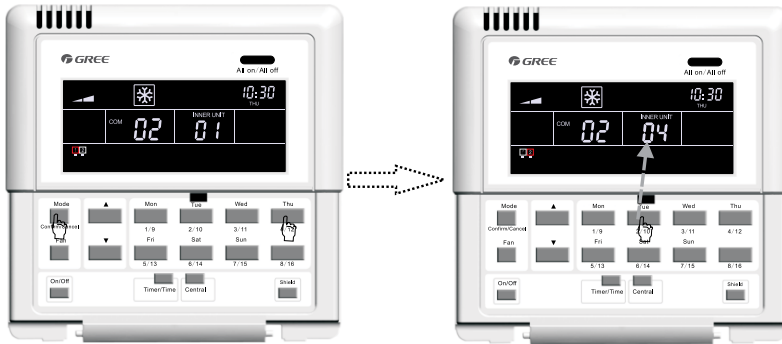

Press “**Mode**” and “**Thu**” simultaneously for five seconds to go to the debugging page.

Press the code button of the indoor unit to inquire about its corresponding serial port and address.

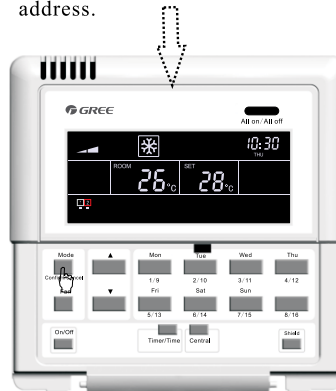

Press “**Confirm/Cancel**” to make a confirmation.

Fig.5.7 Debugging

5.4 Labeling

A label is provided to identify the relationship of the indoor unit No. and the corresponding room name. The user can write down the indoor unit No. and its corresponding room name on the label which then will be stuck to the inside of the cover of the smart zone controller so that the user can be clear about the control object.

For instance, when the user has installed the air conditioners in the child room, bedroom and living room, after the debugging it is available to view the indoor unit No. of each room and get clear about their corresponding relationship.

Room Name	Child Room	Bedroom	Living Room
Indoor Unit Address	Port 1,Indoor Unit 04	Port 1, Indoor Unit 05	Port 1,Indoor Unit 06
Indoor Unit No.	1	2	3

After get clear about the relationship of the indoor unit no. and the room, the user can write “Child Room”, “Bedroom”, “Living Room” on the place “1”, “2” and “3” respectively on the label and then stick the label to the inner side of the smart zone controller.

See 5.8 for the label.

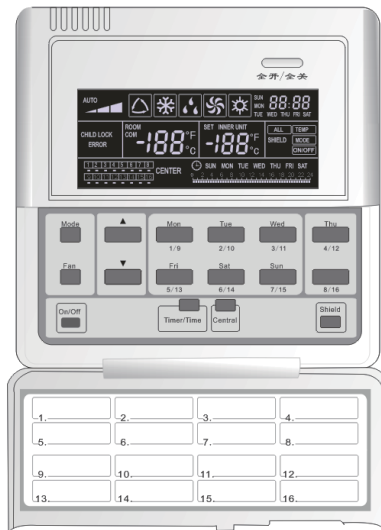

Fig.5.8 Label of the Smart Zone Controller

6 Control Flow Chart

See the following figure for the control flow chart of the smart zone controller.

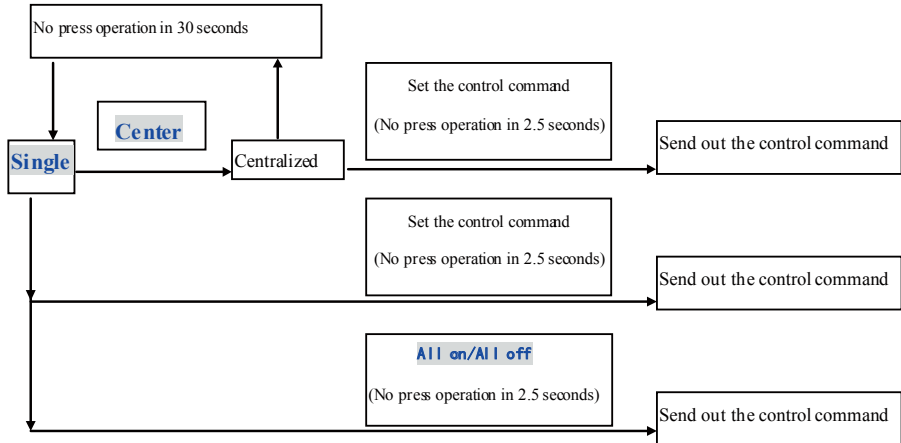

Fig. 6.1 Control Flow Chart of the Smart Zone Controller

Note: As for first energization, or change of process setting, or change of series port, it should be adjusted again (see 5.3 for the method).

7 Viewing of the Running Status of the Indoor Unit and Control Mode

7.1 Viewing of the Running Status of the Indoor Unit

It can be seen generally on the LCD that the minimum code of the online indoor unit flashes, with its running status, set temperature, and shield status etc. displayed. However, it can be replaced by other expected indoor unit through pressing the corresponding indoor unit code button. (If the expected indoor unit is offline, then this operation is null and void with “no” displayed.)

See Fig.7.1 for how to view the running status of the indoor unit.

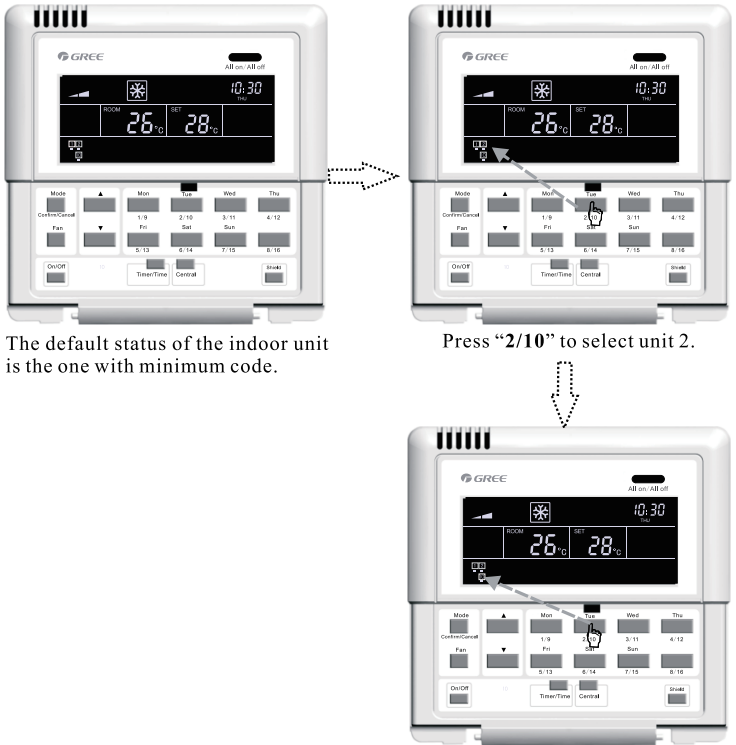

The default status of the indoor unit is the one with minimum code.

Press "2/10" to select unit 2.

Press "2/10" again to select unit 10.

Fig.7.1 Viewing of the Running Status of the Indoor Unit

7.2 Control Mode

7.2.1 Single Control

Select the expected indoor unit through the indoor unit code button and then the code on the LCD will flash.

Set the running status of the indoor unit and send out control commands, including On/Off, Mode, Fan, ▲ / ▼, and Shield etc. Without any change to the setting in 2.5 seconds, the control commands will be sent out.

Fourteen seconds (thirty seconds for the duct type unit) later after the control command is sent out, the set parameters of the indoor unit will be displayed.

See Fig. 7.2 for the temperature control under the single control:

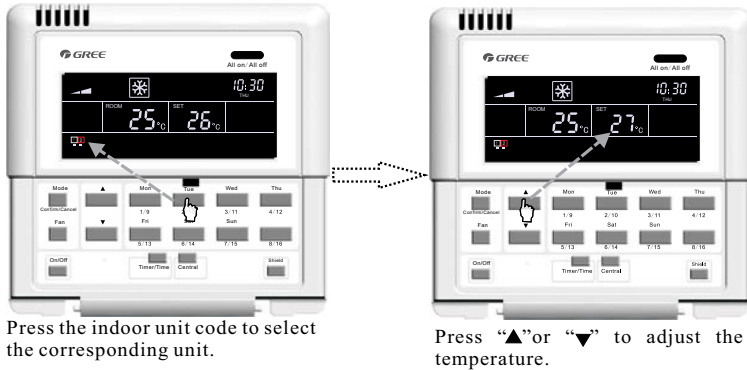

Fig. 7.2 Temperature Control under the Single Control

For other settings, please refer to the following sections.

7.2.2 Centralized Control

Press “Central” to go to the centralized control mode with “CENTER” displayed on the LCD.

Set the running status of the indoor unit and send out control commands, including On/Off, Mode, Fan, ▲ / ▼, and Shield etc. Without any change to the setting in 2.5 seconds, the control commands will be sent out to all online indoor units.

Thirty seconds later after the control command is sent out or by pressing “Central”, then the “CENTER” on the LCD disappears and it will back to the single control mode with the set parameters of the current indoor unit displayed.

See Fig.7.3 for how to go to the centralized control mode.

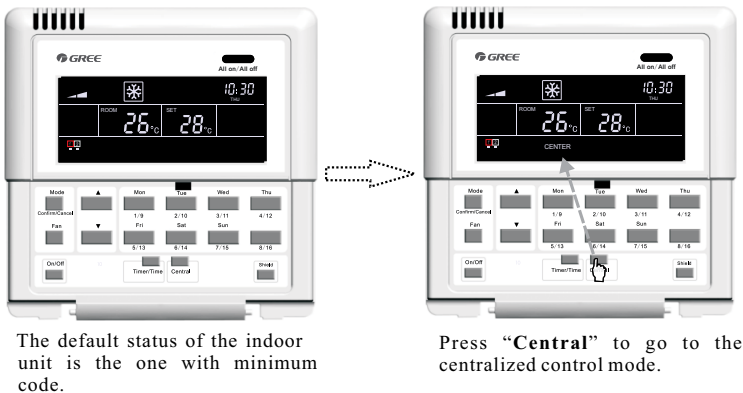

Fig. 7.3 How to Go to the Centralized Control Mode

See Fig. 7.4 for the centralized control to the temperature:

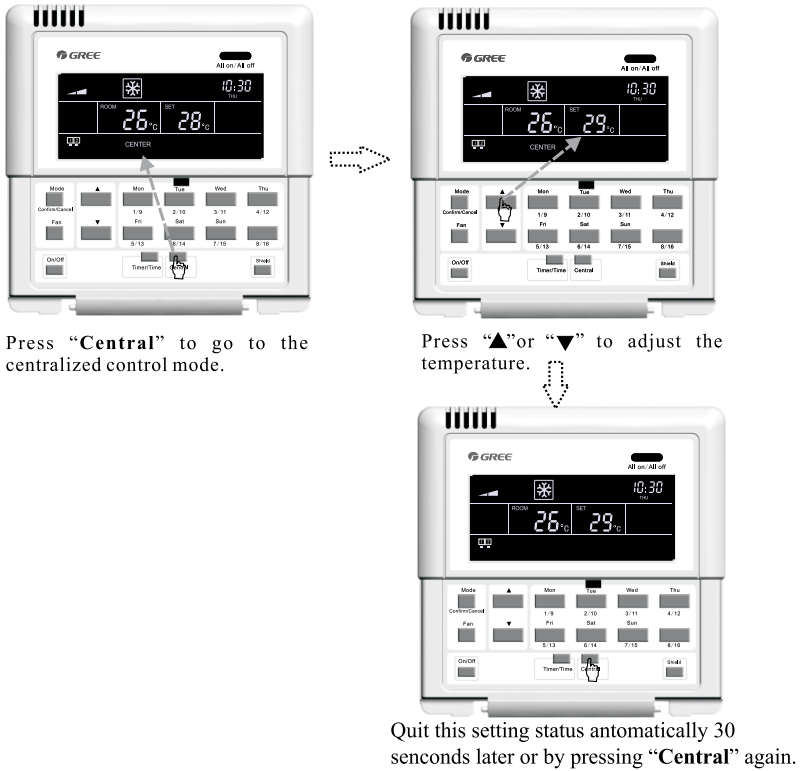

Fig.7.4 Centralized Temperature Control

For other settings, please refer to the following sections.

7.2.3 All on/off

In any case, the current indoor unit which is on/off will be turned off/on by pressing “All on/off” with “CENTER” displayed in the LCD and 2.5 seconds later the control command based on the settings of the current indoor unit will be sent out to all online indoor units. (Including: On/Off, Mode, Fan, ▲ / ▼, and Shield)

7.3 Control Setting

7.3.1 On/Off

The unit will be turned on/off by pressing “On/Off” whenever it is under the single or centralized control. And the control command will be sent out if the setting does not change in 2.5 seconds.

Note: As for the VRF system, on condition that an error occurs to the indoor unit or modes conflicts, whatever the control command is “On” or “Off”, the indoor unit of the VRF system will back to the Off state.

7.3.2 Mode

Under the On state of the unit, whenever it is in single or centralized control, the running mode will change circularly as the following sequence by pressing “Mode”.

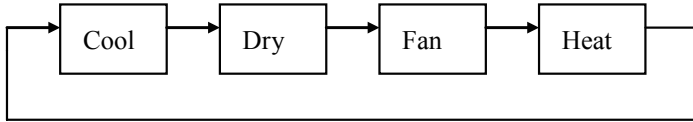

See Fig.7.5 for how to set the running mode.

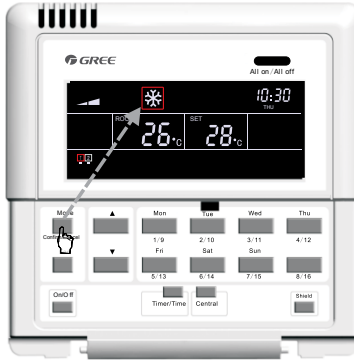

Fig.7.5 Running Mode Setting

If the duct type indoor unit is under the “Auto” mode, and then it is available to view it through the smart zone controller.

7.3.3 ▲ / ▼

Apart from timing and time setting, under the on state of the unit, whenever it is in the single or centralized control, it is enabled to:

Press “▲” to increase the set temperature.

Press “▼” to decrease the set temperature.

The temperature will increase or decrease 1°C every 300 milliseconds by pressing “▲” or “▼”.

Temperature range under each mode: 16°C ~ 30°C / 61°F ~ 86°F .

See Fig.7.6 for how to adjust the temperature:

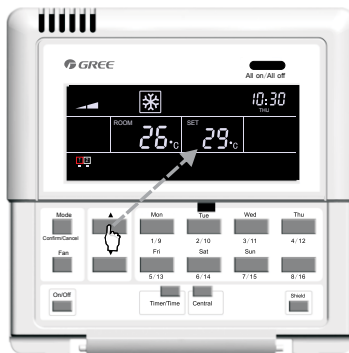

Fig.7.6 Temperature Adjustment

7.3.4 Fan

Under the On state of the unit, whenever it is in single or centralized control, the fan speed will change circularly as the following sequence by pressing “Fan”.

See Fig.7.7 for how to set the fan speed:

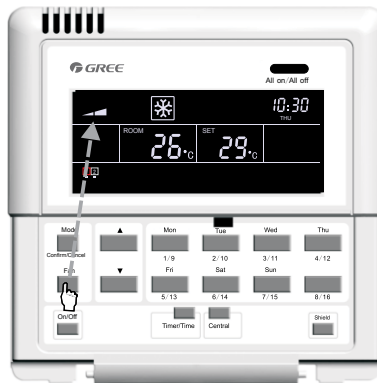
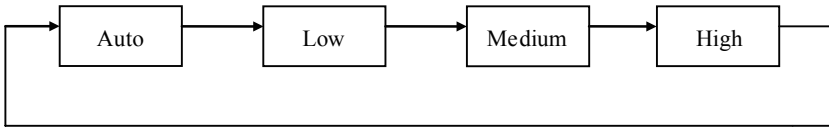

Fig. 7.7 Fan Speed Control

7.3.5 Timer

Timer, namely weekly timer, taking one week as a cycle, is enabled to set the ON/OFF time (taking 0.5 hour as the unit) of the unit on some day or days in one week and several time periods at the same day and then keep this setting circulating weekly.

Introduction to the weekly timer:

a. Once the weekly timer is set, the unit will automatically be turned on/off as the set time starts/ ends. For instance, on condition that the current time is 9:00 Friday and the setting of the timer is shown as the figure below, then the unit will be turned on at 10:00 and turned off at 10:30 and then again be turned on at 12:30 and off at 13:30.

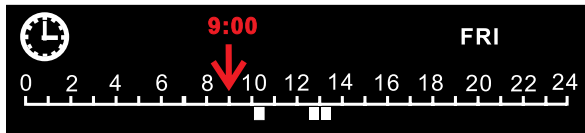

b. The weekly timer does not conflict with the manual On/Off control, that is, the unit can be turned on/off manually even if the weekly timer is set and the unit also can be turned on/off as the setting of the weekly timer.

For instance, on condition that the weekly timer is set as the figure below from 8:00 to 10:00 and from 15:30 to 21:30, the current time is 8:40 Friday and the unit is turned off manually, then the

unit will be automatically turned on at 15:30 and later turned off at 21:30.

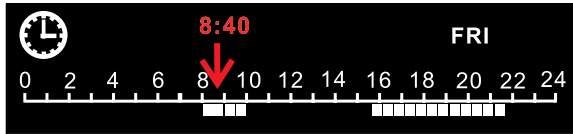

7.3.5.1 How to Set the Weekly Timer under the Single Control

It is available to go to the weekly timer setting page by pressing “Timer/Time” under the single control mode, with “*” flashing (“*” indicates MON, TUE, WED, THU, FRI, SAT, or SUN), and then press the week day button to set the week day. After that, press “Timer/Time” to set the exact time and press “▲” or “▼” to adjust the time period, and finally press “Confirm/Cancel” to confirm this setting (without this press, the setting will not be saved). In the same way, several time periods in one day can be set. After the setting is finished, please press “Timer/ Time” to quit or it will be done automatically 30 seconds later.

See Fig.7.8 for how to set the weekly timer under the single control.

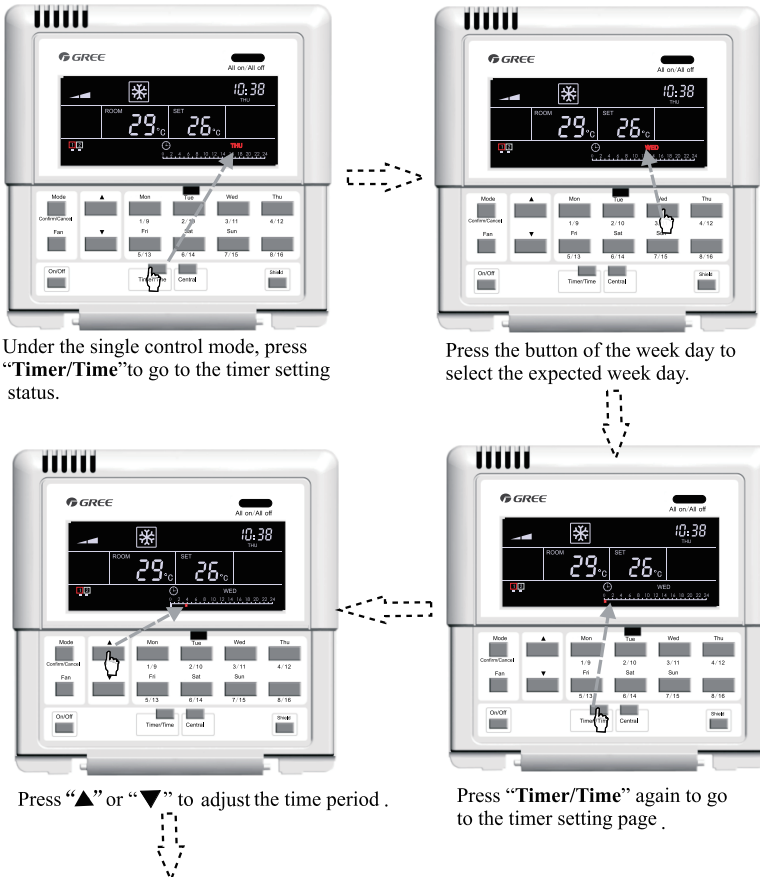

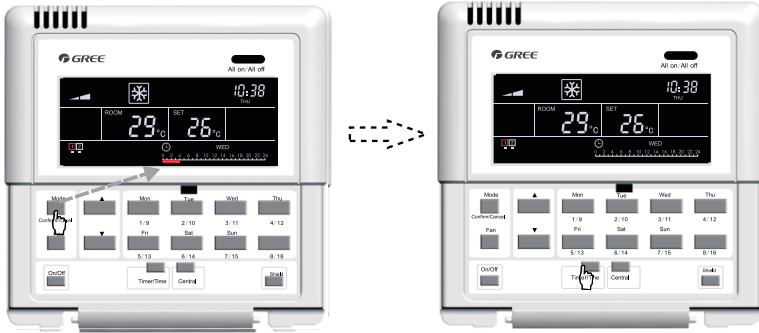

Press **“Confirm/Cancel”** to confirm/cancel the setting.

Quit this setting status automatically 30 seconds later or by pressing **“Timer/Time”**.

Fig.7.8 How to Set the Weekly Timer under the Single Control

7.3.5.2 How to Cancel the Weekly Timer under the Single Control

It is available to go to the weekly timing setting page by pressing **“Timer/Time”** under the single control mode, with **“**”** flashing (**“**”** indicates MON, TUE, WED, THU, FRI, SAT, or SUN), and then press **“Confirm/Cancel”** to cancel the timing (i.e. the set timing period on this day), next, press the week day button to go to the canceling status, after that, press **“Confirm/Cancel”** to cancel the setting on this day.

After the cancellation, it will back to the weekly timer setting page, and then it will quit this page automatically 30 seconds later or by pressing **“Timer/Time”** twice (first press for entering the settings status and the second for quitting the setting status.)

See Fig.7.9 for how to cancel the weekly timer under the single control.

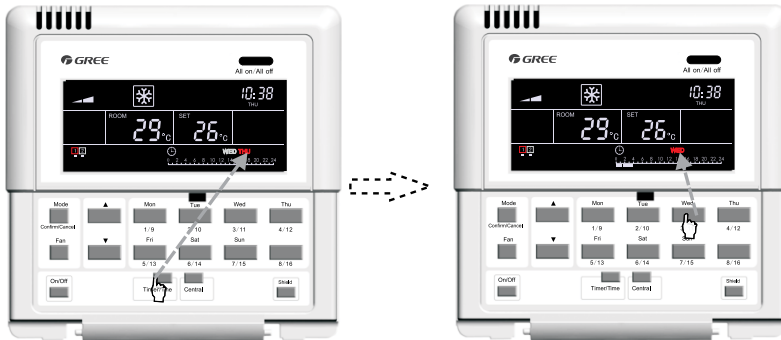

Under the single control status, press **“Timer/Time”** to go to the timer setting page.

Press the button of the week day to select the expected day.

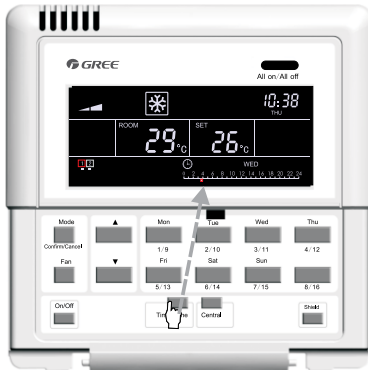

Press “**Timer/Time**” to enter the setting status.

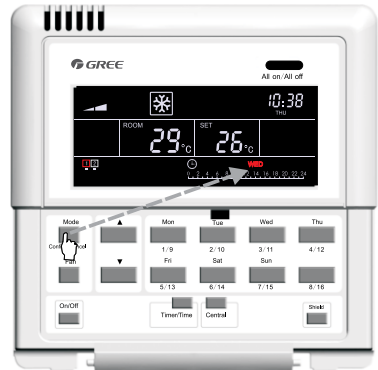

Press “**Confirm/Cancel**” to cancel the setting on this day .

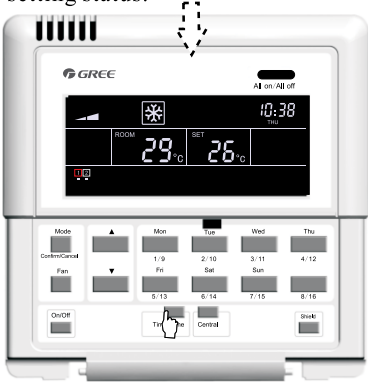

Press “**Timer/Time**” again to quit this setting status.

Fig.7.9 How to Cancel the Weekly Timer under the Single Control

7.3.5.3 How to Set the Weekly Timer under the Centralized Control

It is available to go to the weekly timing setting page by pressing “Timer/Time” under the single control mode , with “*” flashing (“*” indicates MON, TUE, WED, THU, FRI, SAT, or SUN), and then press “Central” with “CENTER” displayed on the LCD which indicates it is the right time to set the weekly timer under the centralized control; after that, press the weekly day button to choose the expected day, press “Timer/Time” to set the exact time and press “▲” or “▼” to adjust the time period, and finally press “Confirm/Cancel” to end this setting (without this press, the setting will not be saved). This setting means this day is timed for all indoor units. Besides, several time periods can be set on one day in the same day stated above.

After the setting, it can quit the timer setting status automatically 30 seconds later or by pressing “Timer/Time”.

See Fig. 7.10 for how to set the weekly timer under the centralized control.

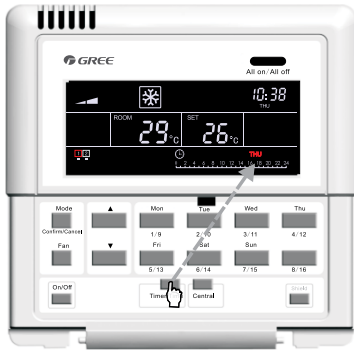

Under the single control status, press “Timer/Time” to go to the timing setting page.

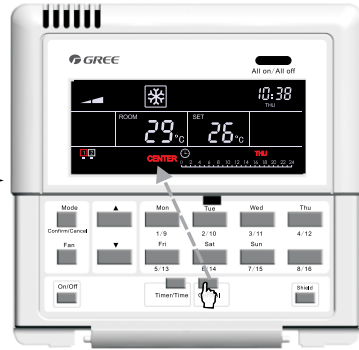

Press “Central” to go to the centralized control mode.

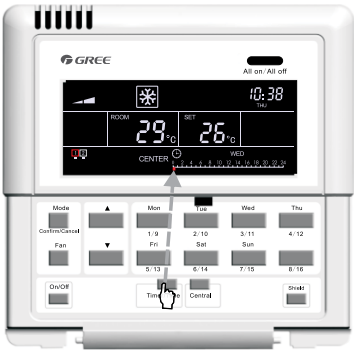

Press “Timer/Time” again to set the timing period on this week day .



Press the button of the week day to select the expected week day.

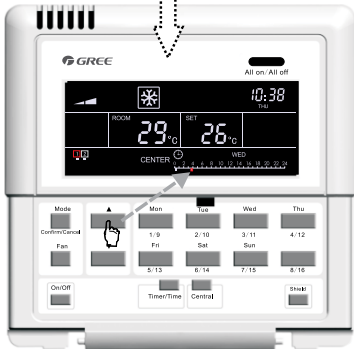

Press “▲” or “▼” to adjust the time period

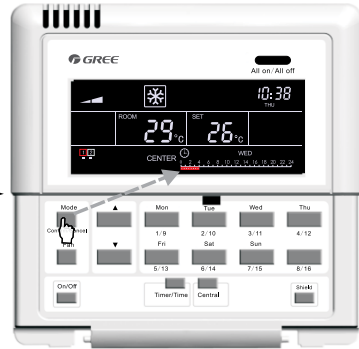

Press “Confirm/Cancel” to confirm/cancel the setting period.

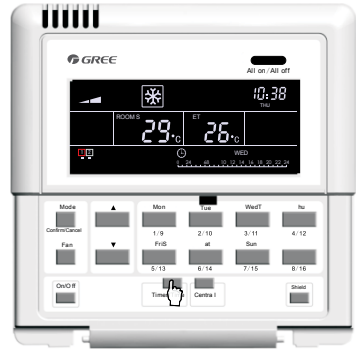

Quit this setting status automatically 30 seconds later or by pressing “Timer/Time”.

Fig.7.10 How to Set the Weekly Timer under the Centralized Control

7.3.5.4 How to Cancel the Weekly Timer under the Centralized Control

It is available to go to the weekly timer setting page by pressing “Timer/Time” under the single control status , with “*” flashing (“*” indicates MON, TUE, WED, THU, FRI, SAT, or SUN), and then press “Central” with “CENTER” displayed on the LCD which indicates it is the right time to set the weekly timer under the centralized control; after that, press the week day button to choose the expected day and then press “Confirm/Cancel” to cancel the setting on this day for all indoor units (i.e. cancel the set time period on this day)

After the cancellation, it will back to the weekly timer setting page under the centralized control, and then it will quit this page automatically 30 seconds later or by pressing “Timer/Time” twice (first press for entering the settings status under the centralized control and the second for quitting this setting status)

See Fig.7.11 for how to cancel the weekly timer under the centralized control:

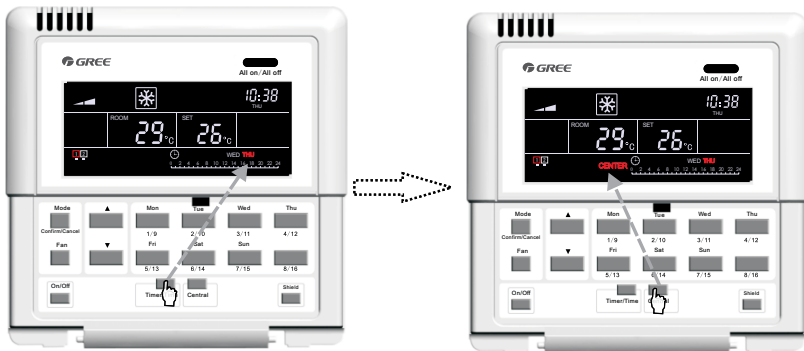

Under the single control status, press “Timer/Time” to go to the timing setting page.

Press “Central” to go to the centralized control mode.

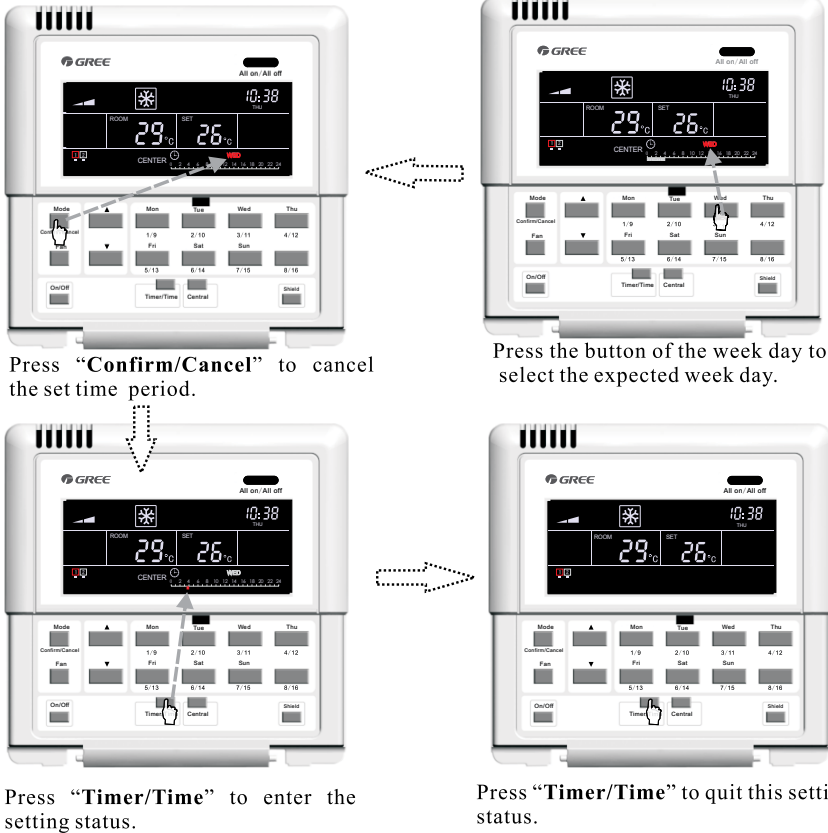
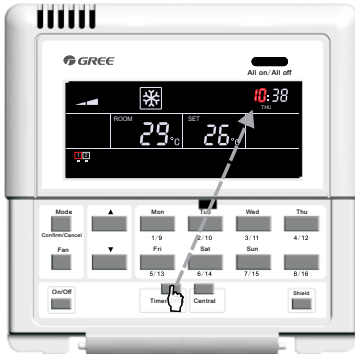

Fig.7.11 How to Cancel the Weekly Timer under the Centralized Control

7.3.6 Time

It is available to go the clock setting status by pressing “Timer/Time” for five seconds, and then press week day button to set the day with **88**: flashing and then press “▲” or “▼” to set the hour. After that, press “Timer/Time” with **:88** flashing and then press “▲” or “▼” to set the minute. By pressing “Timer/Time” or fifteen seconds later, system will quit this setting status.

See Fig.7.12 for how to set the clock:



Press “Timer/Time” for five seconds to go to the clock setting status .

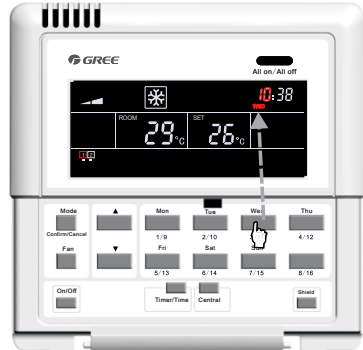

Press the button of the week day to select the expected week day.

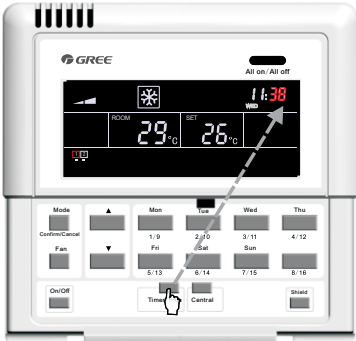

Press “Timer/Time” again to go to minute setting status .

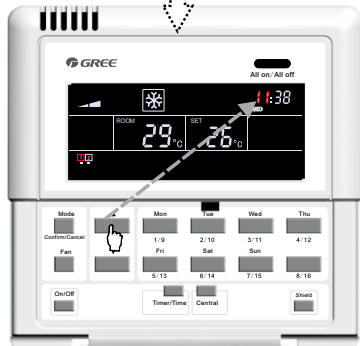

Press “▲” or “▼” to set the hour.

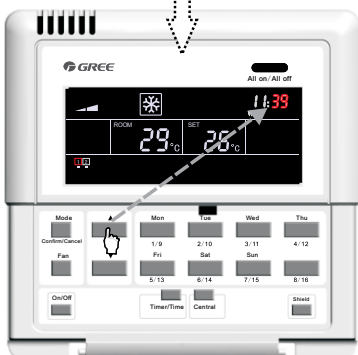

Press “▲” or “▼” to set the minute.

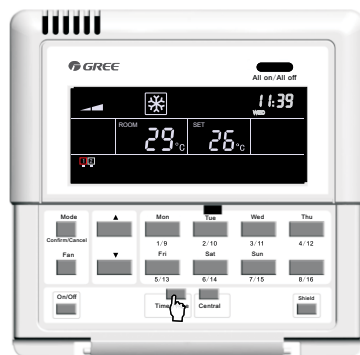

Quit this setting status automatically 15 seconds later or by pressing “Timer/Time”.

Fig.7.12 Clock Setting

7.3.7 Shield

The shield function can be set under either single control or the centralized control and the control command (including: On/Off,, Mode, Fan, ▲/ ▼, and Shield etc.) based on the settings of the current indoor unit will be sent out to all online indoor units 2.5 seconds later..

7.3.7.1 “TEMP” Shield under the Single Control

It is available to activate or deactivate the temperature shield: first press “Shield” with “SHILED” displayed on the LCD, next press it to switch to “TEMP”, and then press “Confirm/Cancel”, after that, “TEMP” will go on or go out but with “MODE” flashing instead. After the setting, it is enabled to quit this setting status by pressing “Shield” three times.

See Fig.7.13 for “TEMP” shield under the single control:

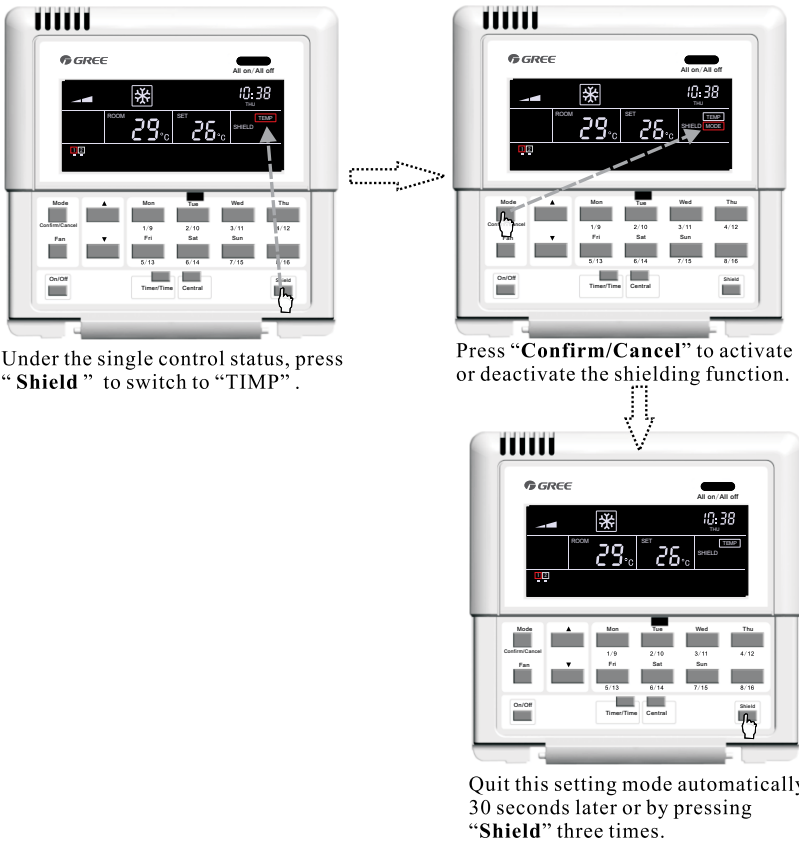
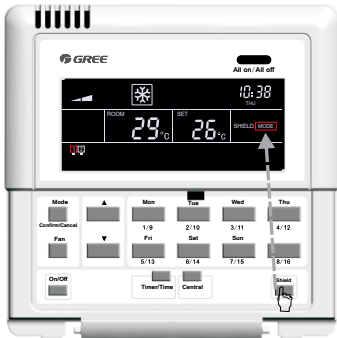

Fig.7.13 “TEMP” Shield under the Single Control

7.3.7.2 “MODE” Shield under the Single Control

It is available to activate or deactivate the mode shield: first press “Shield” with “SHILED” displayed on the LCD, next press it to switch “MODE”, and then press “Confirm/Cancel”, after that, “MODE” will go on or go out but with “ON/OFF” flashing instead. After the setting, it is enabled to

quit this setting status by pressing “Shield” twice.



Under the single control status, press “Shield” to switch to “MODE”.

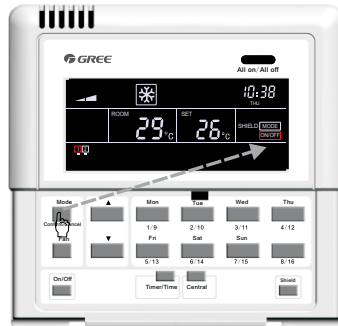

Press “Confirm/Cancel” to activate or deactivate the shielding function.

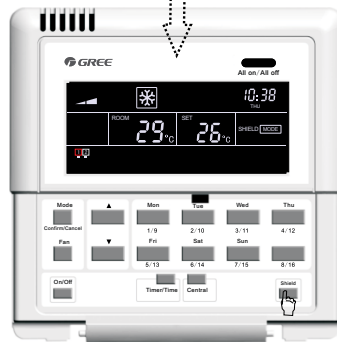

Quit this setting mode automatically 30 seconds later or by pressing “Shield” twice.

Fig.7.14 “MODE” Shield under the Single Control

7.3.7.3 “ON/OFF” Shield under the Single Control

It is available to activate or deactivate the On/off shield: first press “Shield” with “SHILED” displayed on the LCD, next press it to switch to “ON/OFF”, and then press “Confirm/Cancel”, after that, “ON/OFF” will go on or go out but with “ALL” flashing instead. After the setting, it is enabled to quit this setting state by pressing “Shield” once.

See Fig.7.15 for “ON/OFF” shield under the single control:

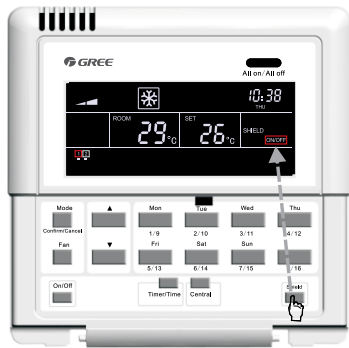

Under the single control status, press “Shield” to switch to “ON/OFF”.

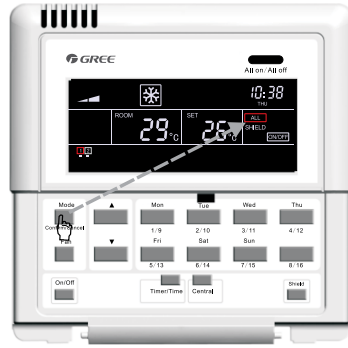

Press “Confirm/Cancel” to activate or deactivate the shielding function.

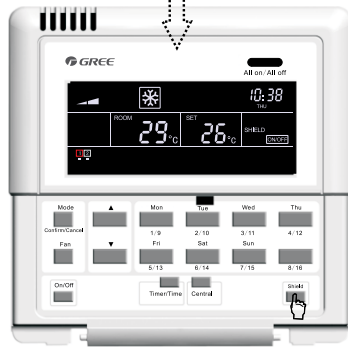

Quit this setting mode automatically 30 seconds later or by pressing “Shield” once.

Fig.7.15 “ON/OFF” Shield under the Single Control

7.3.7.4 “ALL” Shield under the Single Control

It is available to activate or deactivate the All shield: first press “Shield” with “SHILED” displayed on the LCD, next press it to switch to “ALL”, and then press “Confirm/Cancel”, after that, “ON/OFF” will go on or go out and meanwhile quit this setting status.

See Fig.7.16 for “ALL” Shield under the single control:

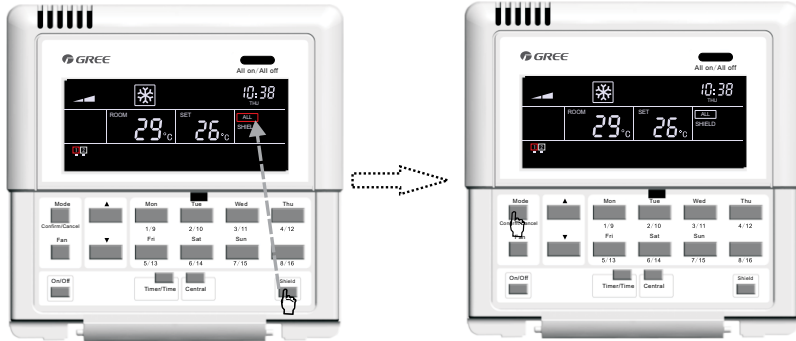

Under the single control status, press “Shield” to switch to “All”.

Press “Confirm/Cancel” to activate or deactivate the shielding function and mean while quit this setting status.

Fig.7.16 “ALL” Shield under the Single Control

Note: if the shield setting is not confirmed by pressing “Confirm/Cancel”, the system will quit this setting status 15 seconds later.

7.3.7.5 “TEMP” Shield under the Centralized Control

It is available to activate or deactivate the temperature shield under the centralized control: first press “Shield” with “SHILED” displayed on the LCD, next press it to switch to “TEMP”, then press “Central” with “CENTER” displayed on the LCD and then press “Confirm/Cancel”, after that, “TEMP” will go on or go out but with “MODE” flashing instead. After the setting, it is enabled to quit this setting status by pressing “Shield” three times.

See Fig.7.17 for “TEMP” shield under the centralized control:

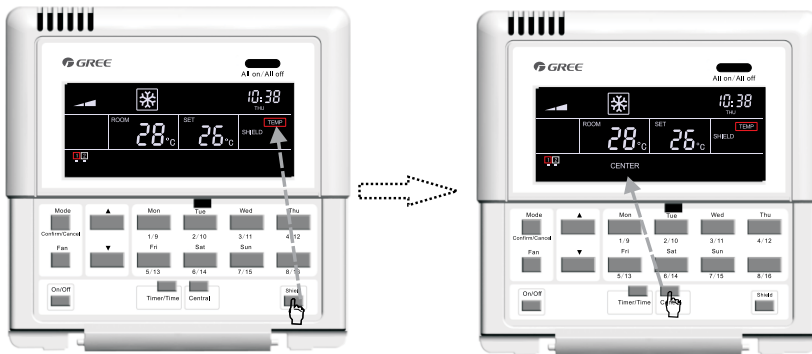

Under the single control status, press “Shield” to switch to “TEMP”.

Press “Central” to go to the shielding setting status under the centralized control.



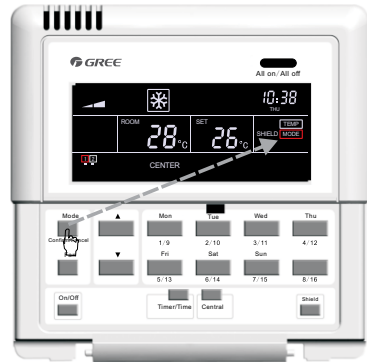
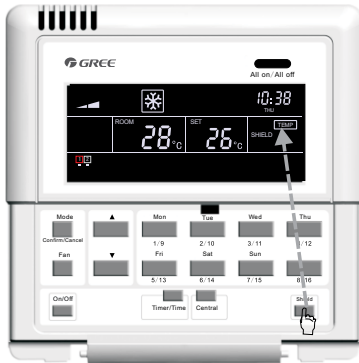

Quit this setting status automatically 30 seconds later or by pressing “Shield” three times.

Press “ Confirm/Cancel ” to activate / deactivate the shielding function.

Fig.7.17 “TEMP” Shield under the Centralized Control

7.3.7.6 “MODE” Shield under the Centralized Control

It is available to activate or deactivate the mode shield under the centralized control: first press “Shield” with “SHILED” displayed on the LCD, next press it to switch to “MODE”, then press “Central” with “CENTER” displayed on the LCD and then press “Confirm/Cancel”, after that, “MODE” will go on or go out but with “ON/OFF” flashing instead. After the setting, it is enabled to quit this setting status by pressing “Shield” twice.

See Fig.7.18 for “MODE” shield under the centralized control:

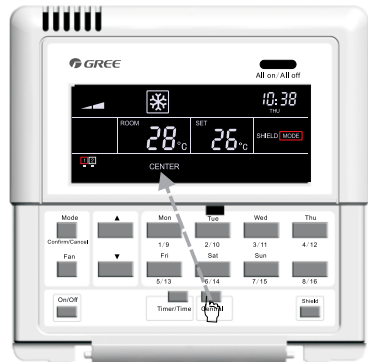
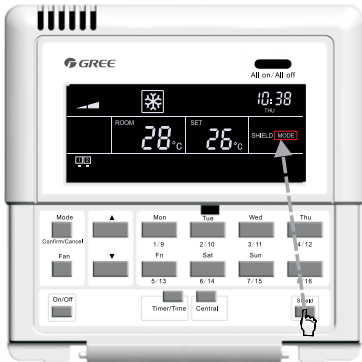

Under the single control status, press “Shield” to switch to “MODE”.

Press “Central” to go to the shielding setting status under the centralized control.

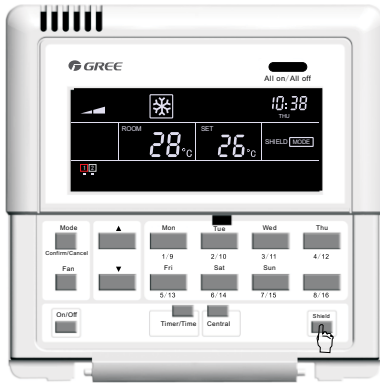

Quit this setting status automatically 30 seconds later or by pressing “Shield” twice.

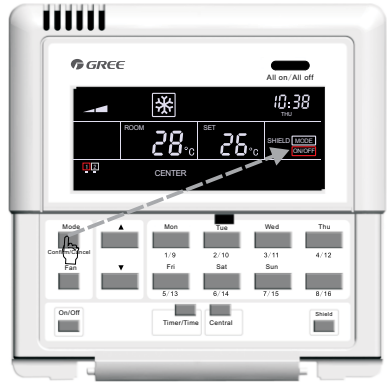

Press “ Confirm/Cancel ” to activate / deactivate the shielding function.

Fig.7.18 “MODE” Shield under the Centralized Control

7.3.7.7 “ON/OFF” Shield under the Centralized Control

It is available to activate or deactivate the On/Off shield under the centralized control: first press “Shield” with “SHILED” displayed on the LCD, next press it to switch to “ON/OFF”, then press “Central” with “CENTER” displayed on the LCD and then press “Confirm/Cancel”, after that, “ON/OFF” will go on or go out but with “ALL” flashing instead. After the setting, it is enabled to quit this setting status by pressing “Shield” once.

See Fig.7.19 for “ON/OFF” shield under the centralized control:

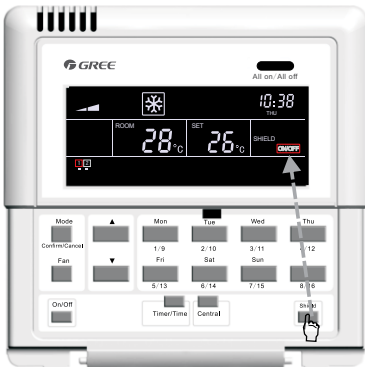

Under the single control status, press “Shield” to switch to “ ON/OFF ”.



Press “Central” to go to the shielding setting status under the centralized control .

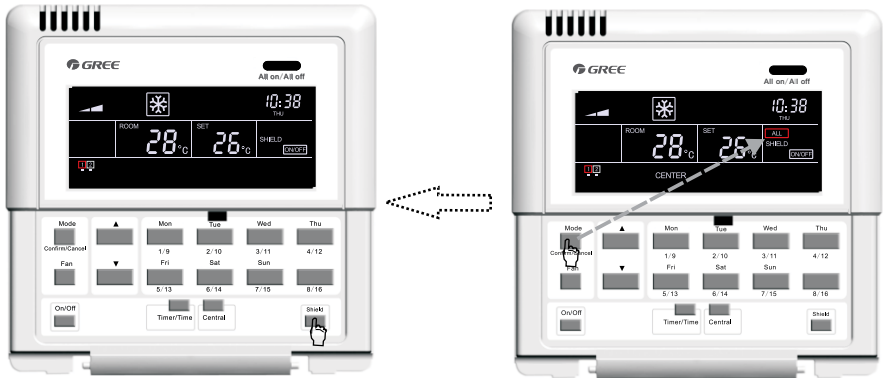

Quit this setting status automatically 30 seconds later or by pressing “Shield” once.

Press “Confirm/Cancel” to activate / deactivate the shielding function.

Fig.7.19 “ON/OFF” Shield under the Centralized Control

7.3.7.8 “ALL” Shield under the Centralized Control

It is available to activate or deactivate the “ALL” shield for the centralized control: first press “Shield” with “SHILED” displayed on the LCD, next press it to switch to “ALL”, then press “Central” with “CENTER” displayed on the LCD and then press “Confirm/Cancel”, after that, “ALL” will go on or go out and quit this setting status at the same time.

See Fig.7.20 for “ALL” shield under the centralized control:

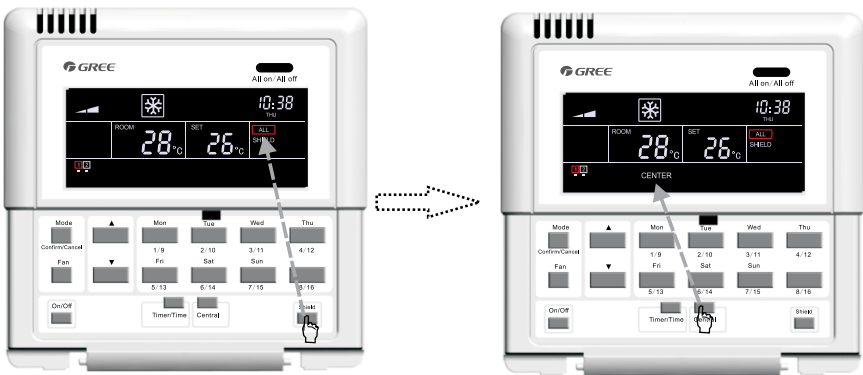

Under the single control status, press “Shield” to switch to “ALL” .

Press “Central” to go to the shielding setting status under the centralized control .



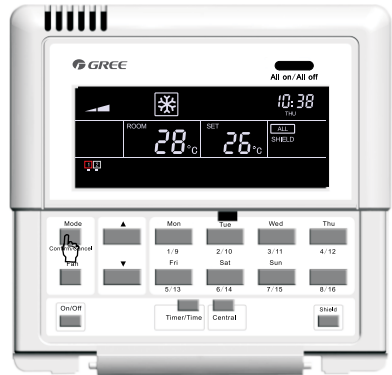

Press “Confirm/Cancel” to activate / deactivate the shielding function and meanwhile quit this setting status.

Fig.7.20 “ALL” Shield under the Centralized Control

Note: if the shield setting is not confirmed by pressing “Confirm/Cancel”, the system will quit this setting status 30 seconds later.

7.3.8 Child Lock

Whenever the unit is on or off, it is enabled to activate the function of the child lock by pressing “▲” or “▼” simultaneously for five seconds, in which case, “CHILD LOCK” will be displayed on the LCD and no button press except the combination of “▲” and “▼” will be answered. And this function can be deactivated by repeating the press stated above.

See Fig.7.21 for how to set the child lock:

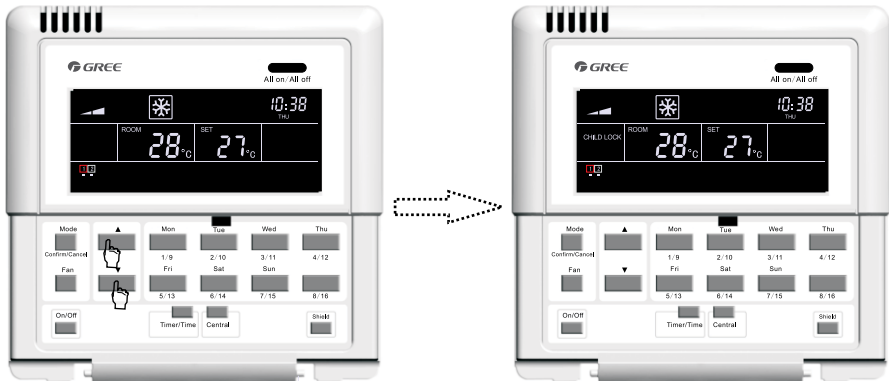

Under the on state of the unit , press “▲” and “▼” simultanelusly for five seconds.

Go to the locking status with “CHILD LOCK” displayed on the LCD.

Fig.7.21 Child Lock

7.3.9 Switchover between Celsius and Fahrenheit

Under the off status of the current indoor unit, symbols of Celsius and Fahrenheit can be switched over by pressing “Mode” and “▼” simultaneously for five seconds.

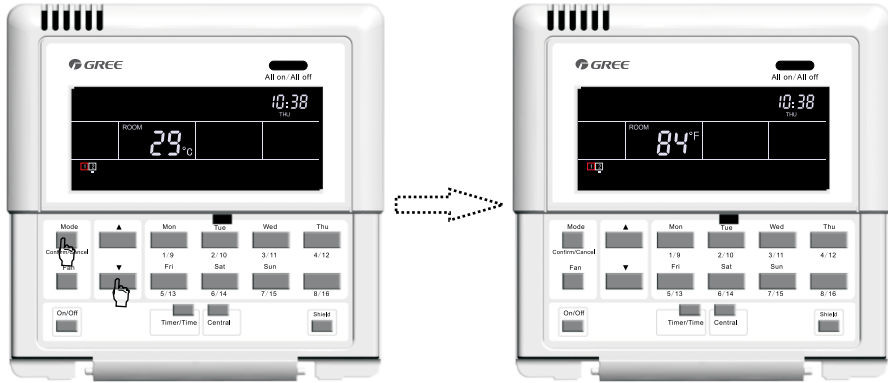

Under the off state of the unit, press “Mode” and “▼”simultaneously for five seconds.

Switch over the Celsius scale and the Fahrenheit.

See Fig.7.22 for the switchover between Celsius and Fahrenheit.

8 Error Display

When some error arises during the operation of the system, error codes will be displayed where the ambient temperature once is displayed on the LCD.

See Fig.8.1 for the error display:



Fig. 8.1 Error Display

See Table 8.1 for errors of the multi VRF indoor units, see Table 8.2 for errors of the duct type indoor units, See Table 8.3 for Error Code Table for Indoor Unit and Outdoor Unit of Free Match

Table 8.1 Errors for Multi VRF Indoor Units

Code	Description
E1	High pressure protection of the compressor
E2	Anti-freezing protection of the indoor unit
E3	Low pressure protection of the compressor
E4	Discharge temperature protection of the compressor
E5	Over-current protection, overload protection of compressor, drive error
E6	Communication error
E7	Mode conflict
E9	Water overflow protection
EH	E-heater protection
F0	Ambient temperature sensor error of the indoor unit
F1	Error of coil pipe inlet sensor of the indoor unit
F2	Error of coil pipe intermediate sensor of the indoor unit
F3	Error of coil pipe outlet sensor of the indoor unit
F4	Ambient temperature sensor error of the outdoor unit
F5	Error of coil pipe inlet sensor of the outdoor unit
F6	Error of coil pipe intermediate sensor of the outdoor unit
F7	Error of coil pipe outlet sensor of the outdoor unit
F8	Error of discharge temperature sensor 1 (fixed)
F9	Error of discharge temperature sensor 2 (digital)
FA	Error of oil temperature sensor 1 (fixed)
Fb	Error of oil temperature sensor 2 (digital)
Fc	High pressure sensor error
Fd	Low pressure sensor error

Table 8.2 Errors for the Duct Type Indoor Unit

Code	Description
E0	Water pump error
E1	High pressure protection of the compressor
E2	Anti-freezing protection of the indoor unit
E3	Low pressure protection of the compressor
E4	High discharge temperature protection of the compressor
E5	Overload protection of the compressor
E6	Communication error
E8	Indoor unit fan protection
E9	Water overflow protection
F0	Indoor ambient temperature sensor error at the return air inlet.
F1	Evaporator temperature sensor error
F2	Condenser temperature sensor error
F3	Indoor ambient temperature sensor error
F4	Discharge temperature sensor error
F5	Ambient temperature sensor error at the display
EH	Auxiliary electrical heater error
FF	Sub-room switch opened
C5	Jumper cap error
C1	Arc control
C2	Electrical leakage protection

Table 8.3 Error Code of Free Match

Code	Description
E1	High pressure protection
E2	Anti-freezing protection
E3	Low pressure protection
E4	High discharge temperature protection
E5	Whole unit over-current protection
E6	Indoor and outdoor communication error
E8	Overload protection
E9	Indoor unit full water error
F0	System charge shortage or blockage protection
F1	Return air temperature sensor open/short circuited
F2	evaporator temperature sensor open/short circuited
F3	Outdoor ambient temperature sensor open/short circuited
F4	Outdoor unit condenser mid-tube temperature sensor open/short circuited
F5	Discharge temperature sensor open/short circuited
C5	Malfunction of Jumper cap
FF	Other malfunctions

GREE ELECTRIC APPLIANCES, INC. OF ZHUHAI

Add: West Jinji Rd, Qianshan, Zhuhai, Guangdong, China, 519070
Tel: (+86-756) 8522218 Fax: (+86-756) 8669426
E-mail: gree@gree.com.cn www.gree.com



66170019