



# User's Manual for Wired Controller XK86

Owner's Manual

---

Commercial Air Conditioners

- Thank you for choosing Air Conditioners, please read this owner's manual carefully before operation and retain it for future reference. If you have lost the Owner's Manual, please contact the local agent or visit [www.gree.com](http://www.gree.com) or send email to [global@gree.com.cn](mailto:global@gree.com.cn) for electronic version.
- GREE reserves the right to interpret this manual which will be subject to any change due to product improvement without further notice.
- GREE Electric Appliances, Inc. of Zhuhai reserves the final right to interpret this manual.

# User Notices

- ◆ The power supply for all indoor units must be unified.
- ◆ Prohibit installing the wired controller at wet or sunshine places.
- ◆ Do not knock, throw or frequently disassemble the wired controller.
- ◆ Do not operate the wired controller with wet hands.
- ◆ In one system network, you must set one indoor unit as the master indoor unit, other indoor units are slave indoor units. (master indoor unit is not needed in heat recovery units and multi-functional residential multi VRF units).
- ◆ When two wired controllers control one (or more) indoor unit(s), the address of wired controller should be different.
- ◆ Functions with “\*” are optional for indoor units. If a function is not included in an indoor unit, wired controller can't set the function, or setting of this function is invalid to the indoor unit.

# Contents

1 Appearance and display .....	1
2 Status bar instructions.....	2
3 Installation and Commissioning .....	4
3.1 Installation of Wired Controller .....	6
3.2 Commissioning .....	13
4 Operation Instructions .....	23
4.1 On/Off.....	23
4.2 Mode setting.....	24
4.3 Temperature setting .....	26
4.4 Fan setting.....	28
4.5 Timer setting.....	28
4.6 Function setting .....	33
4.7 Power consumption query* .....	43
4.8 Service hotline query .....	44
4.9 Language setting.....	45
4.10 Sound setting.....	46
4.11 Date and time setting.....	46
4.12 Remote Shield Function.....	46
4.13 Gate-control Function .....	46
5 Error display .....	47
5.1 Table of error codes for outdoor unit.....	47
5.2 Table of error codes for indoor unit .....	49
5.3 Table of debugging codes .....	51
5.4 Table of status codes .....	52

# 1 Appearance and display

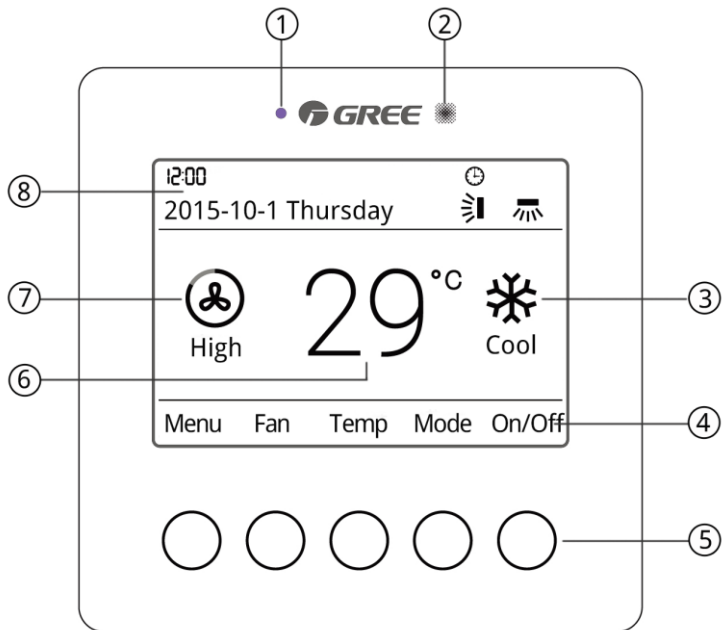





Fig.1.1 Appearance and display

Table 1.1 Appearance and display instructions











No.	Name	Instructions
1	LED	Light up when buttons are pressed or signals are received from remote controller
2	Remote signal receiving window	For receiving signals from remote controller
3	Mode display	Indicating the operating mode
4	Names of buttons	Indicating the names of buttons
5	Touch buttons	Corresponding to the names of buttons
6	Temperature display	Indicating set temperature
7	Fan speed display	Indicating set fan speed
8	Status bar	Indicating date, time, and activated functions (If the unit has power calculation function, daily power consumption will be displayed on status bar)

## 2 Status bar instructions

Table 2.1 Status bar instructions

Icon	Name	Instructions
	Up and down swing	Up and down swing
	Left and right swing	Left and right swing
	Master	If the current wired controller is connected with a master indoor unit, this icon will be displayed (If it is connected with a heat recovery unit or temperature-humidity dual-control duct type indoor unit, this icon won't be displayed)

## Wired Controller XK86

	Group control	If one wired controller is controlling multiple indoor units, this icon will be displayed
	Slave wired controller	Indicating the current wired controller is a slave wired controller (address is 02)
	Shield	Shield status
	Gate-control	Indicating the gate-control card is pulled out
	Child lock	Child lock status
	Invalid	Indicating invalid operation
	Malfunction	Indicating that the unit is malfunctioning
	Memory	Memory status (When power is connected after power failure, indoor unit will resume its previous settings)
	Defrost	Indicating that outdoor unit is under defrosting status
	Timer	Indicating timer function is activated
	Clean	Indicating filter cleaning reminder is on

### 3 Installation and Commissioning

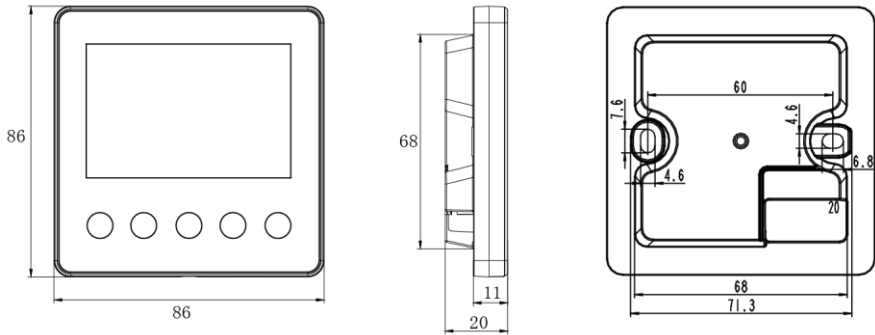

Unit: mm

Fig. 3.1 Dimension of wired controller

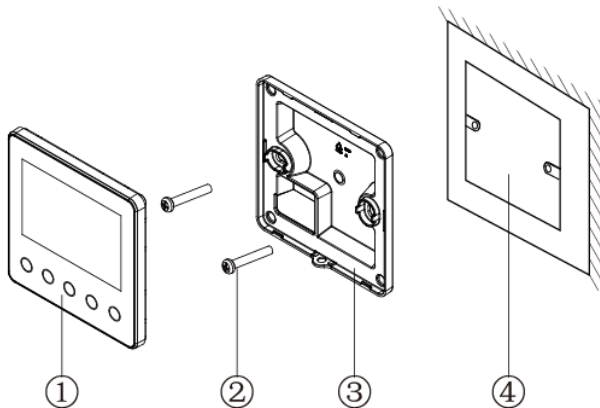

Fig. 3.2 Parts of wired controller

No.	1	2	3	4
Name	Panel of wired controller	Screw M4*25	Soleplate of wired controller	Junction box mounted in the wall space
Q'ty	1	2	2	Parts supplied by users



## 3.1 Installation of Wired Controller

### 3.1.1 Communication Line Selection

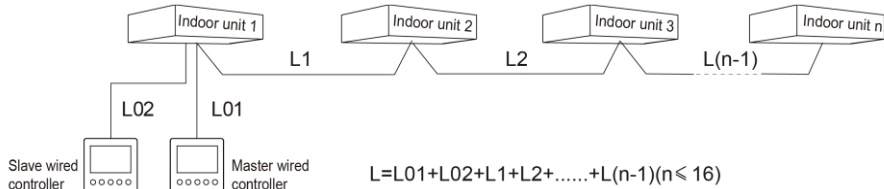

Fig. 3.3 Length of communication line

Wire material type	Total length of communication line between indoor unit and wired controller L (m/feet)	Wire size (mm <sup>2</sup> /A WG)	Material standard	Remarks
Light/Ordinary polyvinyl chloride sheathed cord. (60227 IEC 52 /60227 IEC 53)	L ≤ 250m (L ≤ 820-1/5feet)	2×0.75~ 2×1.25 (2×AWG 18~2×A WG16)	IEC 60227-5: 2007	<ul style="list-style-type: none"> <li>① Total length of communication line can't exceed 250m (820-1/5feet).</li> <li>② The cord shall be Circular cord (the cores shall be twisted together).</li> <li>③ If unit is installed in places with intense magnetic field or strong interference, it is necessary to use shielded wire.</li> </ul>

**Note:**

- ① If the air conditioner is installed at the strong electromagnetic interference place, communication line of the wired controller must use shielding twisted pair.
- ② Materials of communication line for wired controller must be selected according to this instruction manual strictly.

### 3.1.2 Installation requirements

- (1) Prohibit installing the wired controller at wet places.
- (2) Prohibit installing the wired controller at direct sunshine places.
- (3) Prohibit installing the wired controller at the place near high temperature objects or water-splashing places.
- (4) Prohibit installing the wired controller at the place where faces forward to the window. Prevent abnormal work due to the interference from the other wired controller around.

### 3.1.3 Wiring Requirements

There are four network wiring methods between wired controller and indoor unit:

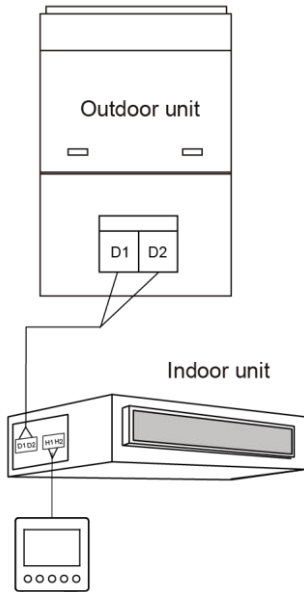

Fig. 3.4 One wired controller controls one indoor unit

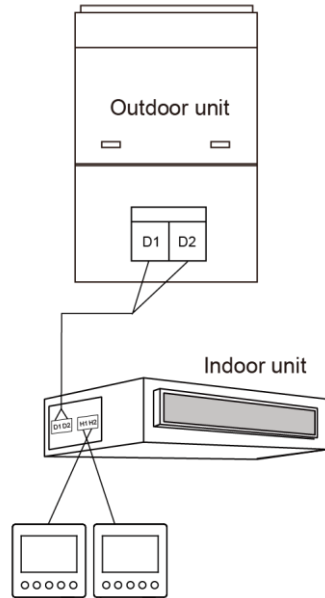

Fig. 3.5 Two wired controllers control one indoor unit

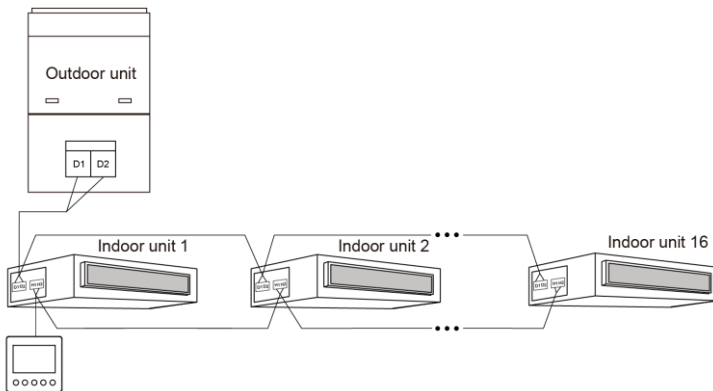

Fig. 3.6 One wired controller controls multiple indoor units simultaneously

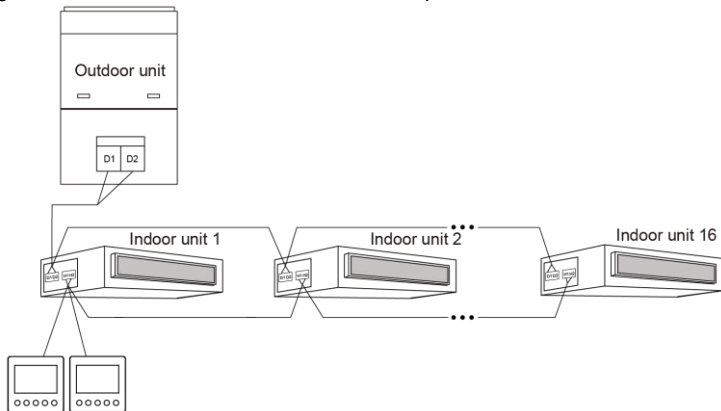

Fig. 3.7 Two wired controllers control multiple indoor units simultaneously

Wiring instruction:

- (1) When one wired controller controls multiple indoor units simultaneously, the wired controller can connect to any one indoor unit, but the connected ones must be units of the same series. The total quantity of indoor unit controlled by wired controller can't exceed 16 sets, and the connected indoor unit must be within the same network. The number of indoor units in group control must be set. Please refer to section 3.2.2 Parameter Setting for the setting method.
- (2) When two wired controllers control one indoor unit, the addresses of those two wired controllers should be different. One should be master controller and the other should be slave controller. Please refer to section 3.2.2 Parameter Setting for the setting method.
- (3) When two wired controllers control multiple indoor units simultaneously, they can connect to any one indoor unit, but the connected ones must be units of the same series. One should be master controller and the other should be slave controller. Please refer to 3.2.2 Parameter Setting for the setting method of master and slave wired controllers. The total quantity of units controlled by wired controller can't exceed 16 sets, and the connected indoor units must be within the same network. The number of units in group control must be set. Please refer to section 3.2.2 Parameter Setting for the setting method.

- (4) When one (or two) wired controller(s) control (s) multiple indoor units at the same time, the controlled units should have the same setting.
- (5) Network connection of wired controller and indoor units must be according to one of the four wiring methods as shown in fig 3.4-3.7. As for the connection method shown in fig 3.5 and 3.7, there should be only one master wired controller (address is 01) and one slave wired controller (address 02). The quantity of wired controller can't exceed two.

**Note:** Series of indoor units include:

- ① Common Multi VRF Units;
- ② Fresh Air Units;
- ③ Double-heat Sources Units;
- ④ Combined Units; Except for fresh air units, double-heat sources units and combined units, the rest of indoor units belong to common multi VRF units.

### 3.1.4 Installation

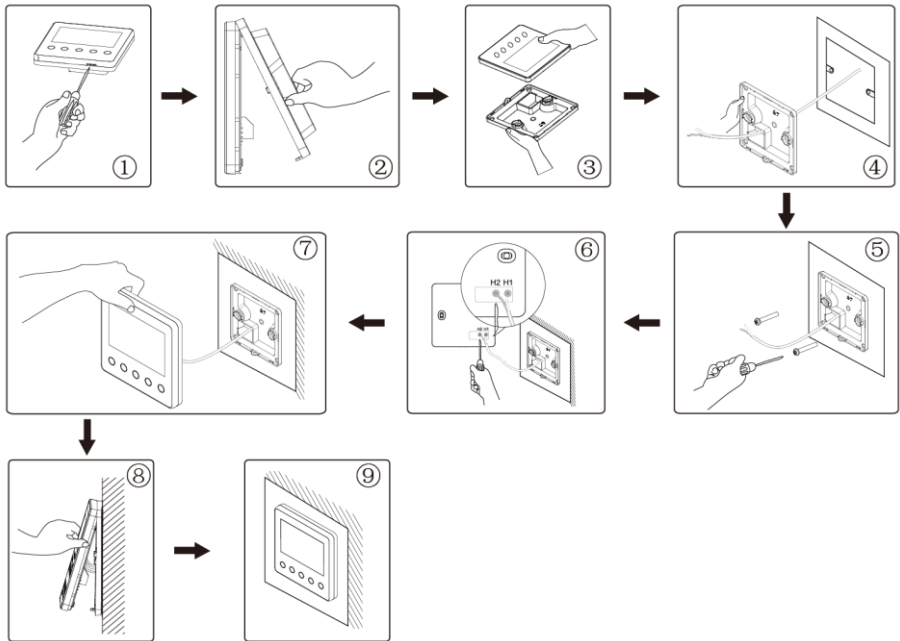

Fig. 3.8 Installation diagram for wired controller

Fig. 3.8 is the simple installation process of wired controller; please pay attention to the following items:

- (1) Before installation, please cut off the power for indoor unit.
- (2) Pull out the 2-core twisted pair from the installation hole on wall, and pull this wire through the connecting hole at the rear side of the soleplate of wired controller.
- (3) Stick the bottom plate of wired controller on the wall and then use screw M4×25 to fix Soleplate and installation hole on wall together.
- (4) Connect two-core twisted pair to H1 and H2 wiring column and then fix the screws.
- (5) Bundle the front panel of wired controller to its soleplate and the installation is completed.

### 3.1.5 Disassembly

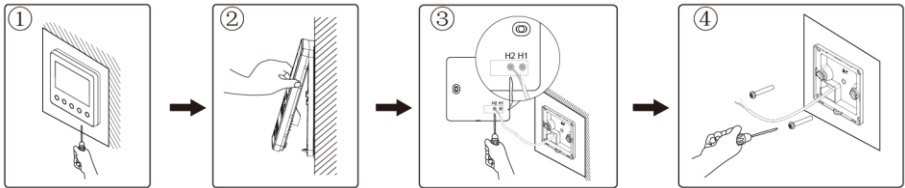

Fig. 3.9 Disassembly diagram of wired controller

## 3.2 Commissioning

### 3.2.1 Parameter enquiry

Parameters can be checked whether unit is on or off.

Press "Menu" button on homepage to enter the menu page. Then select "View"



to enter the interface of view. Then select "Project View" to enter the interface of project view, as shown below.

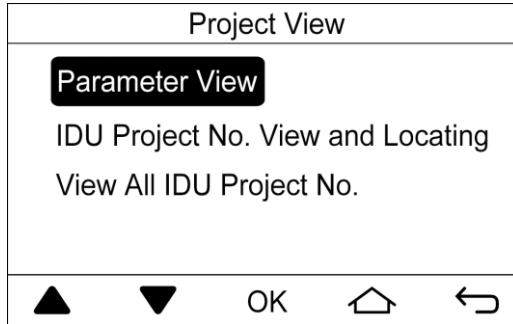

(1) IDU project No. view and locating

On the interface of project view, select "IDU Project No. View and Locating". As shown below, indoor unit project number and error code will be displayed.

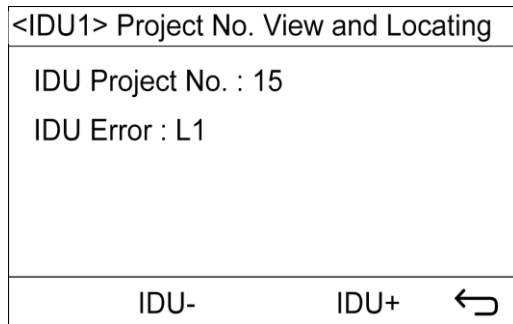

If there are multiple indoor units, press "IDU-" or "IDU+" to switch different indoor units. Project numbers and error codes of indoor units will be displayed correspondingly. If there are several errors in one indoor unit, error codes will be displayed circularly at an interval of 3 seconds. If there is no error, "Null" will be displayed.

After entering the interface of IDU project number view and locating, buzzer of the selected indoor unit will ring until the wired controller exits the interface.

(2) View all IDU project No.

On the interface of project view, select "View All IDU Project No.". As shown below, turn on or turn off "View All IDU Project No.".

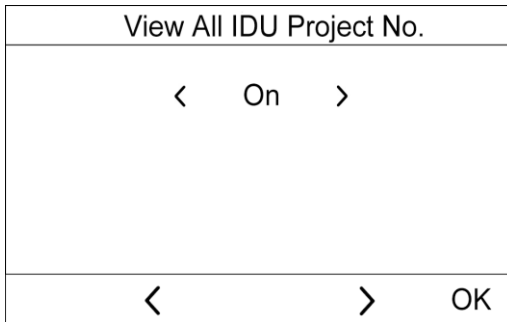

After turning on "View All IDU Project No.", all indoor units and wired controllers of the same network will display project numbers. For wired controller, it will display the project numbers of indoor units one by one from small number to large number at

an interval of 3 seconds.



After turning on "View All IDU Project No.", you can enter the interface of "View All IDU Project No." to turn this function off, or you can press "On/Off" button on any one wired controller of the network to cancel the display of indoor unit project numbers.

### (3) Parameter view

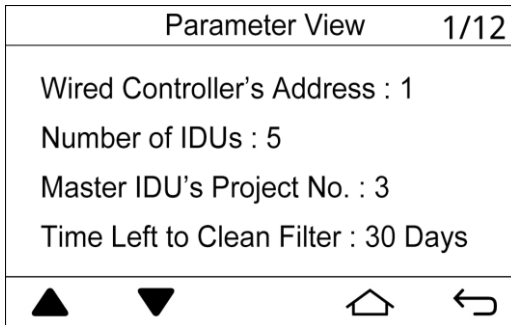
On the interface of project view, select "Parameter view". As shown below, a list of parameters can be enquired. Please refer to table 3.1 "List of parameters view".



When enquiring indoor unit parameters, if there are multiple indoor units, press "IDU-" or "IDU+" to switch different indoor units. Parameters of the corresponding unit will be shown as below.

<IDU1> IDU Parameter View	3/12
IDU Error Log : L1, L4, d3, d4, d6	
Prior Operation : No	
Indoor Temp : 25°C	
Relative Humidity : 65%	
	 IDU- IDU+ 

When enquiring outdoor unit parameters, if there are multiple outdoor units, press "ODU-" or "ODU+" to switch different outdoor units. Parameters of the corresponding outdoor unit will be shown as below.



<ODU1> ODU Parameter View	7/12
ODU Static Pressure : 50 Pa	
ODU Error Log : C2	
Outdoor Temp : 30°C	
Comp1 Operation Freq : 100Hz	
	 ODU- ODU+ 

Table 3.1 List of parameters view

Parameter name	scope	Parameter name	scope
Wired Controller's Address	1, 2	Number of IDUs	1~16
Master IDU's Project No.	1~255	Time Left to Clean Filter	0~416 days
Online IDUs of CAN1	1~80	CAN2 Address	1~255
Max Distribution Ratio	110%, 135%, 150%	Cool & Heat Modes	Cool only; Heat only; Cool & heat; Fan
IDU Error Log	5 historical errors	Prior Operation	Yes, No
Indoor Temp	-9~99°C	Relative Humidity	20%~90%
Inlet Temp 1	-9~99°C	Outlet Temp 1	-9~99°C
Inlet Temp 2	-9~99°C	Outlet Temp 2	-9~99°C
IDU Capacity	Indoor unit capacity and capacity after adjustment	EXV Status	0~20
Fresh Air IDU Output Temp	Actual value	ODU Static Pressure	0, 20, 50, 80
ODU Error Log	5 historical errors		
<b>The following parameters can be checked only on the master wired controller.</b>			
Unit Code	0~9, A~Z, a~z,-	Board Code	0~9, A~Z, a~z,-
Outdoor Temp	-30~139°C	Comp1 Operation Freq	0~200Hz
Comp2 Operation Freq	0~200Hz	ODU Fan Operation Freq	0~100Hz
Module High Pressure	-40~70°C	Module low pressure	-69~38°C
Comp1 Discharge Temp	-30~150°C	Comp2 Discharge Temp	-30~150°C

## Wired Controller XK86

Comp3 Discharge Temp	-30~150°C	Comp4 Discharge Temp	-30~150°C
Comp5 Discharge Temp	-30~150°C	Comp6 Discharge Temp	-30~150°C
Comp3 Operation Freq	0~200Hz	ODU Heating EXV1	0~48
ODU Heating EXV2	0~48	Subcooler EXV	0~48
Defrosting Temp	-30~139°C	Subcooler Liquid Temp	-30~139°C
Separator Outlet Temp	-30~139°C	Oil Return Temp	-30~139°C
Condenser Inlet Temp	-30~139°C	Condenser Outlet Temp	-30~139°C







### Note:

- ① Under the status of parameter enquiry, signals from remote controller are ineffective.
- ② If a parameter is invalid, wired controller displays “--” .

## 3.2.2 Parameter setting

Unit parameters can be set in unit On or Off status.

Press "Menu" button on homepage to enter the menu page. Then select "Set" to enter the interface of settings. Then select "Project set" to enter the interface of project parameter setting, as shown below. Please refer to table 3.2 for the list of parameter settings.

Parameter Setting		1/10
<input checked="" type="checkbox"/> Master Wired Controller	<input checked="" type="checkbox"/> Master IDU	
<input checked="" type="checkbox"/> Use Remote	<input type="checkbox"/> Prior Operation	
<input type="checkbox"/> High Ceiling Installation	<input type="checkbox"/> Link with Fresh Air IDU	
<input type="checkbox"/> In °F		
  OK PgDn 		
Parameter Setting		2/10
➤ Clear Filter Cleaning Time		
Reset WiFi		
IDU Fan Static Pressure: 5		
Number of IDUs: 8		
  OK PgDn 		

Press “▲” or “▼” to switch among different settings. Press and hold the buttons to switch quickly.

If you select a parameter with “■” or “□” on the left, press “OK” to turn it on or turn it off. “■” means ON while “□” means OFF. If you select a parameter with icon “➤” on the left, press “OK” to enter the setting interface of the corresponding parameter.

Press “PgDn” button to switch to the next page.

Table 3.2 List of parameter settings

Setting	Setting scope	Default	Remarks
Master Wired Controller	ON, OFF	ON	OFF means this wired controller is a slave wired controller. The icon of slave wired controller “  21



			Otherwise, the temperature unit is Celsius.
Clear Filter Cleaning Time	Clear; Don't Clear	Don't Clear	
Reset WiFi*	Reset; Don't reset	Don't reset	
IDU Fan Static Pressure	1~9	5	
Number of IDUs	0: Disable this function; 1-16: Number of indoor units	1	Set a corresponding value according to the number of connected indoor units.
Angle of Air-return Board*	Angle 1 Angle 2 Angle 3	Angle 1	Only applicable to units with air return plate.
Cooling temp of Auto Mode	17°C~30°C (63°F~86°F)	25°C(77°F)	Cooling temperature of auto mode – Heating temperature of auto mode $\geq 1^{\circ}\text{C}$ .
Heating temp of Auto Mode	16°C~29°C (61°F~84°F)	20°C(68°F)	
Cooling Temp of Fresh Air IDU*	16°C~30°C (61°F~86°F)	18°C(64°F)	Only applicable to fresh air indoor units.
Heating Temp of Fresh Air IDU*	16°C~30°C (61°F~86°F)	22°C(72°F)	Only applicable to fresh air indoor units.
Relative Humidity of Auto Dry*	65%~85%	75%	Only applicable to temperature-humidity dual-control duct type indoor unit
Relative Humidity of Absence*	65%~85%	75%	Only applicable to temperature-humidity dual-control duct type indoor unit
Temp of Absence Mode*	5~10°C (41°F~50°F)	8°C(46°F)	Only applicable to temperature-humidity dual-control duct type indoor unit

**Note:**

- ① Setting of parameters not listed above can only be accessed with password.
- ② Under the status of parameter setting, signals from remote controller are ineffective.

## 4 Operation Instructions

### 4.1 On/Off

Press "On/Off" button on homepage to turn on the air conditioner.

Press "On/Off" button again to turn it off.

The interfaces of ON and OFF are as shown in Fig.4.1 and 4.2.

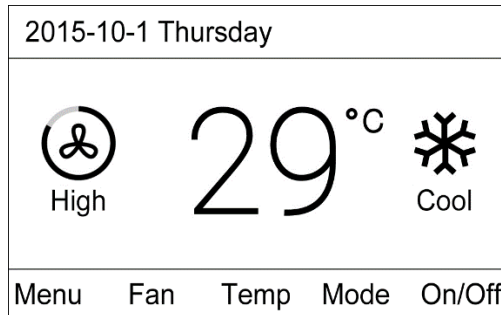

Fig.4.1 Interface of ON

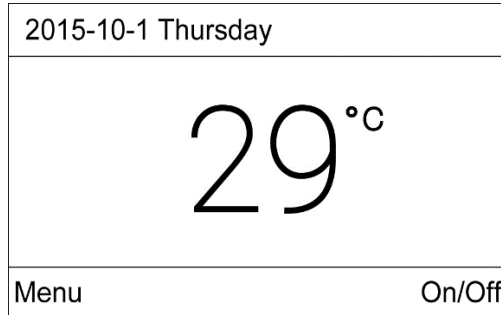

Fig. 4.2 Interface of OFF

## 4.2 Mode setting

Under ON status, pressing "Mode" button on homepage can switch modes circularly in the following order:

Auto -> Cool- > Dry -> Fan -> Heat -> Floor Heat -> 3D Heat -> Space Heat -> Auto

If wired controller is connectegd to temperature-humidity dual-control duct type indoor unit, modes will be switched in the following order:

Cool -> Auto Dry -> Dry Reheat -> Fan -> Heat -> Absence -> Floor Heat -> 3D Heat->Cool

**Note:**

- ① Different models have different operating modes. Wired controller will select the types of mode automatically according to the models of indoor units.
- ② Only the master indoor unit can set up Auto mode (not applicable to heat recovery units).
- ③ Instructions on mode switch:
  - a) For heat recovery units, any one indoor unit can switch to different modes freely;
  - b) For multi-functional residential multi VRF units, if only one indoor unit has been turned on, this unit can switch to any mode; if multiple indoor units have been turned on, system mode will be the mode of the unit that is first turned on and other units cannot switch to a mode that is in conflict with system mode.
  - c) For other types of indoor unit, the operation mode of the system is basing on that of master indoor unit. Master indoor unit can switch to any modes, while slave unit can't switch to the mode that is conflicting with master indoor unit. When master indoor unit changes mode which cause operation mode of slave indoor unit conflicts with that of system, the operation mode of slave unit will switch to the operate mode of system automatically.

## 4.3 Temperature setting

Under ON status, press "Temp" button on homepage to enter the interface of temperature setting, as shown below. Then press "▲" or "▼" button to increase or decrease temperature by 1°C. If you press and hold the buttons, temperature will be increased or decreased by 1°C in every 0.3 second. After setting the temperature, press "↩" button to return to homepage.

Under the mode of Cool, Dry Reheat, Fan, Heat, Floor Heat, 3D Heat and Space Heat, temperature setting range is 16°C~30°C.

Under Dry mode, temperature setting range is 12°C, 16°C~30°C. When unit is operating in drying mode and temperature is 16°C, pressing "▼" button twice can change the temperature to 12°C (If Save function for Cool is enabled, drying temperature cannot be set to 12°C and its setting range is "lowest temperature in Save mode" ~ 30°C).

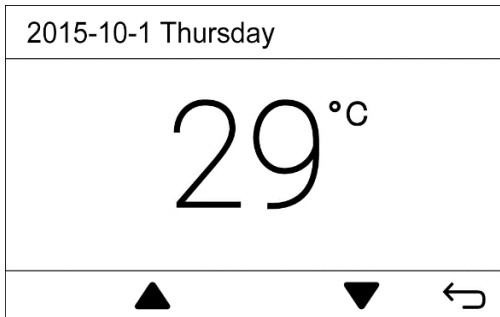

**Note:**

- ① After Absence function is enabled, pressing “▲” or “▼” button can not change the temperature.
- ② Under Auto mode, wired controller cannot enter the interface of temperature setting. You can set the cooling temperature and heating temperature of Auto mode in project parameter setting.
- ③ Under Auto Dry mode or Absence mode, homepage will not display set temperature and wired controller cannot enter the interface of temperature setting. Temperature can only be adjusted in project parameter setting.
- ④ Under Dry Reheat mode, you can enter the interface of temperature setting and set the temperature and relative humidity at the same time.
- ⑤ If wired controller is connected to fresh air indoor unit, homepage will not display set temperature. Temperature display zone will display the code of fresh air indoor unit "FAP". Wired controller cannot enter the interface of temperature setting. Cooling temperature and heating temperature can only

be set in project parameter setting.

- ⑥ If wired controller is connectegd to temperature-humidity dual-control duct type indoor unit, pressing “▲” or “▼” button can increase or decrease temperature by 0.5°C.

## 4.4 Fan setting

Under ON status, pressing "Fan" button on homepage can switch fan speed circularly in the following order:

Auto->Low->Medium Low->Medium->Medium High->High->Auto

### Note

- ① Under Dry or Auto Dry mode, low fan speed is set automatically. Fan speed cannot be adjusted.
- ② Under Absence mode, auto fan speed is set automatically. Fan speed cannot be adjusted.
- ③ If wired controller is connected to fresh air indoor unit, high fan speed is set automatically. Pressing "Fan" button cannot change the fan speed.
- ④ If auto fan speed is set, indoor unit will change fan speed automatically according to indoor ambient temperature.

## 4.5 Timer setting

Wired controller has two types of timer setting: general timer and periodical timer.

Press "Menu" button on homepage and then select "Timer" to enter the interface of timer setting. As shown below, Timer 1, 2, 3 refer to periodical timer. Periodical timer and general timer can be enabled at the same time. Timer function is turned on if "■" is displayed on the left. Timer function is turned off if "□" is displayed.

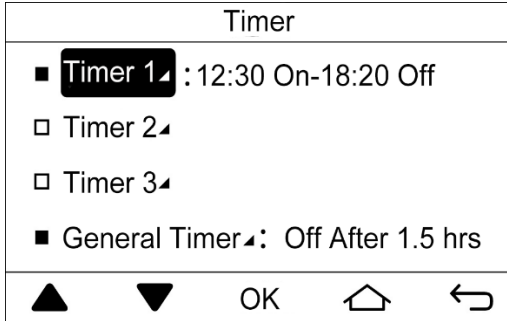

On the interface of timer setting, press "▲" or "▼" button to switch to a different item. Press "OK" to enter the interface of the corresponding timer setting.

#### 4.5.1 General timer

Under ON status, you can set General timer to turn unit off. Under OFF status, you can set General timer to turn unit on.

On the interface of timer setting, select "General Timer" to enter the setting of general timer. As shown below, set timer to turn unit on or turn unit off and set the timer time. Press "OK" to save the timer setting and return to the previous page.



Range of timer time: 0.5~24 hours

General Timer				
On				
< 0.5 h >				
▲	▼	<	>	OK

#### 4.5.2 Periodical timer

On the interface of timer setting, select "Timer 1" or "Timer 2" or "Timer 3" to enter the setting of periodical timer. See below (take Timer 1 as an example):

To ensure time accuracy, please check the current system date and time before setting the timer. If date and timer are wrong, please reset them on the interface of "Date & Time".

Timer 1	
■ On	Cool ▾
■ 08 : 00 On▾	27°C ▾
■ 17 : 00 Off▾	High ▾
■ Repeat▾ : Everyday	
▲	▼
OK	⏪ ⏩

On the interface of Timer 1, press “▲” or “▼” button to switch to a different item. Select the first item and press "OK" button to turn on or off Timer 1. When selecting other items, press "OK" button to enter the interface of the corresponding setting.

Enter the interface of mode setting, temperature setting or fan speed setting to set up the mode, temperature or fan speed that unit is going to perform when it is turned on through timer.

If you want to just turn unit on through timer, set the time for unit ON. If you want to just turn unit off through timer, set the time for unit OFF. If you want to turn unit on and off through timer, set the time for unit ON and OFF. Below is the interface of setting time for unit ON. On the interface of setting time for unit ON or OFF, press. “▲” or “▼” button to switch to a different selection. Press “<” button or “>” button to switch between ON and OFF or to adjust time. Press "OK" button to save the setting and return to the previous page.

On Time	
< On >	
Hour :	12
Minute :	30
▲ ▼ < >	OK

On the interface of Timer 1, select "Repeat" to enter the following interface, where you can set the days for timer to be effective. Press "▲" or "▼" button to switch to a different selection. Press "OK" button to confirm or cancel the corresponding selection. Press "↶" button to save the setting and return to the previous page.

Timer-Repeat	
<input type="checkbox"/> Everyday	<input checked="" type="checkbox"/> Thursday
<input checked="" type="checkbox"/> <b>Monday</b>	<input checked="" type="checkbox"/> Friday
<input checked="" type="checkbox"/> Tuesday	<input type="checkbox"/> Saturday
<input checked="" type="checkbox"/> Wednesday	<input type="checkbox"/> Sunday
▲ ▼	OK ↶

Note: Timer function cannot be set in Absence mode.



## 4.6 Function setting

Select "Function" on Menu page to enter the interface of function setting as shown below.

Press "▲" or "▼" button to switch among different items. Press "OK" button to turn on or off the corresponding function. "■" showing on the left means the corresponding function is ON while "□" means OFF. Press "PgUp" or "PgDn" to switch to a previous page or a next page. Press "↩" button to save the setting and return to the previous page.

When selecting the item with "▲" (Quiet, U&D Swing Position, L&R Swing Position, Air, Clean, Save), press "OK" button to enter the setting interface of the corresponding function.

Function		1/2
■ Up & Down Swing	□ Sleep	□ Lock
■ Left & Right Swing	■ Light	□ Rapid
□ Quiet	▲	□ Absence □ X-fan
▲	▼	OK PgDn ↩

Function		2/2
<input type="checkbox"/> U&D Swing Position	<input checked="" type="checkbox"/> Air	<input type="checkbox"/> Clean
<input type="checkbox"/> L&R Swing Position	<input checked="" type="checkbox"/> Save	<input type="checkbox"/> Health
<input type="checkbox"/> 12-Drying	<input checked="" type="checkbox"/> E-heater	<input type="checkbox"/> Turbo
		OK PgUp 

**Note:**

- ① Sometimes, some functions may be invalid. Invalid functions are displayed in grey. Press “▲” or “▼” button will skip the invalid function.
- ② After Child lock function is ON, wired controller will be back to the homepage and buttons will be invalid. Unlock the wired controller according to the hint and buttons will be valid again.

**Introduction of functions:**

**Sleep:** Indoor unit runs in sleep mode after this function is ON. Unit will run based on a preset temperature curve in order to provide a comfortable sleeping environment for users. Sleep function can be enabled in Cool, Dry, Heat, 3D Heat or Space Heat mode.

**Lock:** Buttons are invalid after this function is ON. User needs to unlock according to the hint given by the wired controller.

**Light:** This function can control the ON and OFF of indoor unit lamp board.

**Rapid:** This is used to raise or lower temperature to a set value quickly upon startup. Rapid function can be enabled only in Cool mode or Heat mode.

**Absence:** This is used to maintain indoor temperature so that unit can perform heating quickly upon startup. Absence function can be enabled only in Heat mode. If wired controller is connected to temperature-humidity dual-control duct type indoor unit, Absence function cannot be used.

**X-fan:** This is used to dry indoor evaporator after unit is turned off to avoid mildew. X-fan function can be enabled only in Cool or Dry mode.

**Health\*:** This is used to turn on or off Health function.

**12-Drying:** This function can be enabled in Dry mode. After this function is ON, set temperature of Dry mode turns to 12°C.

**Turbo:** This is used to turn on the highest fan speed. After this function is ON, Turbo will be displayed on the homepage.

## 4.6.1 Setting of Swing Position

### (1) U&D Swing Position\*:

On the function interface, select "U&D Swing Position" to enter the setting of up and down swing position, as shown below:

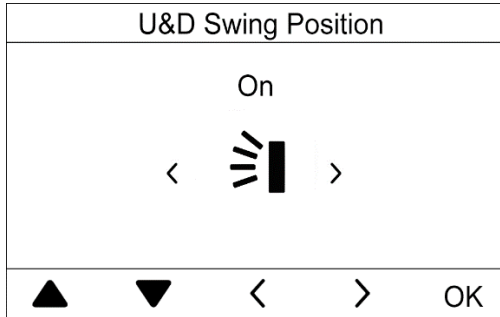

Press “▲” or “▼” button to switch to a different selection. When selecting the first item, press “<” or “>” to select ON or OFF. When selecting the icon of air swing, press “<” or “>” to switch to a different swing angle. The icon of air swing will be displayed in the following order:

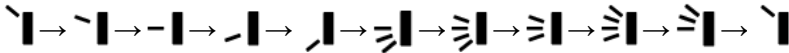

Press "OK" to save the setting and return to the previous page.

## (2) L&R Swing Position\*:

On the function interface, select "L&R Swing Position" to enter the setting of left and right swing position, as shown below:

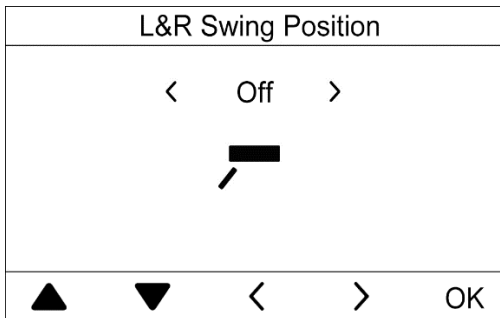

Press “▲” or “▼” button to switch to a different selection. When selecting the first item, press “<” or “>” to select ON or OFF. When selecting the icon of air swing, press “<” or “>” to switch to a different swing angle. The icon of air swing will be displayed in the following order:

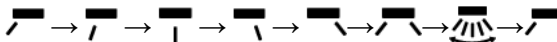

Press "OK" to save the setting and return to the previous page.

## 4.6.2 Setting of Quiet function

Quiet: This is used to reduce indoor unit noise. Quiet function includes Quiet mode and Auto Quiet mode. Quiet function can be enabled in Auto mode, Cool mode, Dry mode, Auto Dry mode, Dry Reheat mode, Fan mode, Heat mode, 3D Heat mode and Space Heat mode.

On the function interface, select "Quiet" to enter the setting of Quiet function, as



shown below:

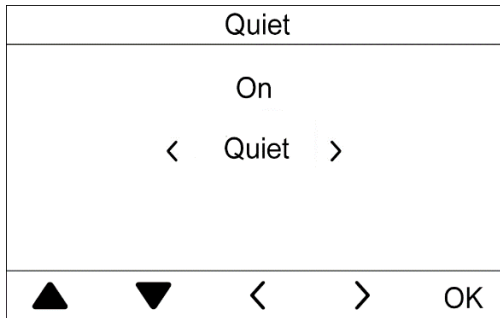

Press “▲” or “▼” button to switch to a different selection. When selecting the first item, press “<” or “>” to select ON or OFF. When selecting the second item, press “<” or “>” to switch between "Quiet" and "Auto Quiet". Press "OK" to save the setting and return to the previous page.

**Note:**

- ① When Quiet mode is ON, indoor unit will run at a quiet fan speed. Fan speed is lowered to reduce noise of indoor unit.
- ② When Auto Quiet mode is ON, indoor unit will change fan speed based on room temperature. When room temperature reaches a set value, unit will run at a quiet fan speed.

### 4.6.3 Setting of Air function\*

Air: This is used to adjust the fresh air volume indoors to improve air quality.

On the function interface, select "Air" to enter the setting of Air function, as shown below:

Air				
<		On	>	
Level :		1		
▲	▼	<	>	OK

Press "▲" or "▼" button to switch to a different selection. When selecting the first item, press "<" or ">" to select ON or OFF. When selecting the second item, press "<" or ">" to switch to a different air degree. The range of air level is 1~10. Press "OK" to save the setting and return to the previous page.

**Note:**

- ① Air function is applicable only to units with air function and installed with fresh air electric valve (fresh air valve in short).
- ② Air level is related to the opening time of fresh air valve in a certain time (60 minutes). Please see the table below. Opening time of fresh air valve indicates the first N minutes within a certain time. For example: if air degree is set to 1, unit starts to count the time and fresh air valve is open. 6 minutes later, fresh air valve is closed while unit continues operating. When the unit





counts to 60 minutes, it will restart counting and fresh air valve is open. 6 minutes later, fresh air valve is closed. Unit operates circularly like this.

level	1	2	3	4	5	6	7	8	9	10
Opening time of fresh air valve	60/6	60/12	60/18	60/24	60/30	60/36	60/42	60/48	60/54	Open all the time
Note: Above time indicates unit operating time (min) / fresh air valve opening time(min)										

#### 4.6.4 Setting of Save function

Save: This is used to set the lower limit of set temperature in Cool mode, Dry mode and Dry Reheat mode and the upper limit of set temperature in Heat mode, 3D Heat mode and Space Heat mode. Air conditioner operates within a smaller temperature range to realize energy saving.

On the function interface, select "Save" to enter the setting of power saving function, as shown below:

Save	
On	
Mode:	Cool
Lower Temp Limit:	< 27°C >
	   OK

Press “▲” or “▼” button to switch to a different selection. When selecting the first item, press “<” or “>” to select ON or OFF. When selecting the second item, press “<” or “>” to switch to a different mode. When selecting the third item, press “<” or “>” to set the upper or lower limit of temperature. Press "OK" to save the setting and return to the previous page.

If Save function is ON under Cool mode, Dry mode or Dry Reheat mode, set temperature displayed on homepage cannot be lower than the lower limit of temperature set in Save function. If Save function is ON under Heat mode, 3D Heat mode and Space Heat mode, set temperature displayed on homepage cannot be higher than the upper limit of temperature set in Save function.

#### 4.6.5 Setting of Filter Clean Reminder

Filter Clean Reminder: Air conditioner can record its running time and when it reaches to a certain time, unit can remind user to clean filter. A dirty filter will cause

poor cooling and heating effect, malfunction or even generate bacteria.

On the function interface, select "Clean" to enter the setting of filter cleaning reminding function, as shown below:

Clean				
On				
Current Cleanliness:		A		
Clean Cycle: <		5	>	
▲	▼	<	>	OK

Press "▲" or "▼" button to switch to a different selection. When selecting the first item, press "<" or ">" to select ON or OFF. When selecting the second item, press "<" or ">" to switch to a cleaning degree of the current environment (A, B, C). When selecting the third item, press "<" or ">" to adjust the clean cycle. The range of filter clean cycle is 0~9. Press "OK" to save the setting and return to the previous page.

Filter cleaning reminding time is related to the cleaning degree of current environment and the clean cycle. There are 4 types of filter cleaning condition:

- (1) Filter cleaning reminder is OFF;
- (2) Light pollution: Cleaning degree of current environment is "A". When clean cycle is "0", the accumulative running time is 5500 hours. Every increase of

"1" indicates an increase of 500 hours in running time. When clean cycle is "9", the accumulative running time is 10000 hours;

(3) Medium pollution: Cleaning degree of current environment is "B". When clean cycle is "0", the accumulative running time is 1400 hours. Every increase of "1" indicates an increase of 400 hours in running time. When clean cycle is "9", the accumulative running time is 5000 hours;

(4) Severe pollution: Cleaning degree of current environment is "C". When clean cycle is "0", the accumulative running time is 100 hours. Every increase of "1" indicates an increase of 100 hours in running time. When clean cycle is "9", the accumulative running time is 1000 hours;

Note:

When cleaning time is up, icon  will be displayed on status bar and a reminder box will pop up on homepage to remind user. Press "Done" or "Ignore" to cancel the display. Meanwhile, the accumulative time for "Filter clean reminder" is reset and starts counting again.

## 4.7 Power consumption query\*

On the View interface, select "Consumption" to enter the interface of power consumption query. The list of power consumption that user can query is as follows:

---

No.	Name	Unit
1	Total consumption	KWh
2	Daily consumption	KWh
3	Yesterday consumption	KWh
4	This month consumption	KWh
5	Last month consumption	KWh

Note: Power consumption can be queried only when the wired controller is connected to units with power calculation function.

## 4.8 Service hotline query

On the View interface, select "Hotline" to enter the interface of service hotline query. You can search for "Local Aftersales Tel" and "National Service Hotline".

### 1. National service hotline

The interface of national service hotline includes information and service hotline of Gree Electric Appliances Inc. of Zhuhai.

### 2. Local aftersales Tel

Select "Local Aftersales Tel" to enter the query and setting of local aftersales hotline. See below:

Local Aftersales Tel	
Tel 1 :	4008365315 Clear
Tel 2 :	Set First
	

If local aftersales Tel is not set, it won't be displayed. The number will only be displayed after a local aftersales Tel is set. Select "Set First" or a phone number, then press "OK" to enter the next page to set up the phone number.

After the phone number is set, select "Clear" to clear the corresponding phone number.

Note: Two phone numbers can be set as the local aftersales phone number. This is to help user to quickly search for a service number and contact local aftersales office for timely assistance.

## 4.9 Language setting

On the Set interface, select "Language" to enter the setting of language. You can select Chinese or English.



## 4.10 Sound setting

On the Set interface, select "Sound" to enter the setting of sound. You can turn on or off the sound of button touch.



## 4.11 Date and time setting

On the Set interface, you can select "Date & Time" to set the date and time.

## 4.12 Remote Shield Function

Remote Shield Function: Remote monitor or central controller can disable the relevant functions of wired controller so as to realize the function of remote control.

Remote Shield Function includes all shield and partial shield. When All Shield function is on, all controls of the wired controller are disabled. When Partial Shield function is on, those controls that are shielded will be disabled.

When the remote monitor or central controller activates Remote Shield on the wired controller, "" icon will show. If user wants to control through the wired controller, "" icon will blink to remind that these controls are disabled.

## 4.13 Gate-control Function

When there is Gate-control System, user can insert a card to turn on the unit or pull off a card to turn off the unit. When the card is re-inserted, the unit will recover the operation as state in memory. When the card is pulled off (or improperly inserted), "" icon will show, neither remote control nor operation of wired controller will be

effective and icon “” will be flickering.

**Note:** This model cannot be connected with gate control system on its own because it cannot detect gate control signal directly. To realize gate control display and gate control function, it has to be used with wired controller that includes gate control signal detecting function (used as master and slave wired controller).

## 5 Error display

If malfunction occurs when system is running, wired controller will display error icon “”, error code and project number of the corresponding indoor unit. If multiple malfunctions occur at the same time, error codes will be displayed circularly.

**Note:** If error occurs, please turn off the unit and send for professionals to repair.

### 5.1 Table of error codes for outdoor unit

Error Code	Content	Error Code	Content	Error Code	Content
E0	Outdoor Unit Error	FL	Compressor 3 Current Sensor Error	b4	Subcooler Liquid-out Temperature Sensor Error
E1	High Pressure Protection	Fn	Mode Exchanger Inlet Pipe Temperature Sensor Error	b5	Subcooler Gas-out Temperature Sensor Error
E2	Discharge Low Temperature Protection	FP	Malfunction of DC motor	b6	Gas-liquid separator inlet temperature sensor error

E3	Low Pressure Protection	FU	Compressor 2 Top Temperature Sensor Error	b7	Gas-liquid separator outlet temperature sensor error
E4	Excess Discharge Temperature Protection of Compressor	J1	Compressor 1 Over-current Protection	b8	Outdoor Humidity Sensor Error
F0	Bad Performance of the Outdoor Mainboard	J2	Compressor 2 Over-current Protection	b9	Heat Exchanger Gas-out Temperature Sensor Error
F1	High Pressure Sensor Error	J3	Compressor 3 Over-current Protection	bA	Oil-return Temperature Sensor Error
F3	Low Pressure Sensor Error	J4	Compressor 4 Over-current Protection	bC	Compressor 1 Top Temperature Sensor Detachment Protection
F5	Compressor 1 Discharge Temperature Sensor Error	J5	Compressor 5 Over-current Protection	bE	Malfunction of entry tube temperature sensor of condenser
F6	Compressor 2 Discharge Temperature Sensor Error	J6	Compressor 6 Over-current Protection	bF	Malfunction of exit tube temperature sensor of condenser
F7	Compressor 3 Discharge Temperature Sensor Error	J7	4-way Valve Blow-by Protection	bH	System Clock Malfunction
F8	Compressor 4 Discharge Temperature Sensor Error	J8	System Pressure Over-Ratio Protection	bJ	High and low pressure sensors are connected inversely
F9	Compressor 5 Discharge Temperature Sensor Error	J9	System Pressure Under-Ratio Protection	bL	Compressor 2 Top Temperature Sensor Detachment Protection
FA	Compressor 6 Discharge Temperature Sensor Error	JA	Protection of Abnormal Pressure	P0	Compressor Drive Board Error

## Wired Controller XK86

Fb	Compressor 2 Top Temperature Sensor Error	JC	Protection of Water Flow Switch	P1	Compressor Drive Board Malfunction
FC	Compressor 2 Current Sensor Error	JE	Oil return pipe is blocked	P2	Protection of Compressor Drive Board Power Supply
Fd	Mode Exchanger Outlet Pipe Temperature Sensor Error	JF	Oil return pipe is leaking	P3	Protection of Compressor Drive Board Module Reset
FE	Compressor 4 Current Sensor Error	JL	Protection of Low High-pressure	H0	Error of Fan Drive Board
FF	Compressor 5 Current Sensor Error	b1	Outdoor Ambient Temperature Sensor Error	H1	Malfunction of Fan Drive Board
FH	Compressor 1 Current Sensor Error	b2	Defrosting Temperature Sensor 1 Error	H2	Protection of Fan Drive Board Power Supply
FJ	Compressor 6 Current Sensor Error	b3	Defrosting Temperature Sensor 2 Error		

## 5.2 Table of error codes for indoor unit

Error Code	Content	Error Code	Content	Error Code	Content
L0	Indoor Unit Error	LH	Low Air Quality Warning	db	Special Code: Field Debugging Code
L1	Indoor Fan Protection	LJ	Wrong Setting of Function DIP Switch	dC	Capacity DIP Switch Setting Error.
L2	E-heater Protection	LP	Zero-crossing malfunction of PG motor	dE	Indoor Unit CO2 Sensor Error
L3	Water Full Protection	LU	Inconsistent Branch of Group-controlled Indoor	dH	Wired Controller PC-Board Error

			Units in Heat Recovery System		
L4	Wired Controller Power Supply Error	d1	Indoor Unit PC-Board Error	dL	Outlet Air Temperature Sensor Error
L5	Anti-Frosting Protection	d3	Ambient Temperature Sensor Error	dn	Swing Assembly Error
L7	No Master Indoor Unit Error	d4	Inlet Pipe Temperature Sensor 1 Error	y1	Inlet Pipe Temperature Sensor 2 Error
L8	Power Insufficiency Protection	d5	Malfunction of middle tube temperature sensor	y2	Outlet Pipe Temperature Sensor 2 Error
L9	Quantity Of Group Control Indoor Units Setting Error	d6	Outlet Pipe Temperature Sensor 1 Error	y7	Fresh Air Inflow Temperature Sensor Error
LA	Indoor Units Incompatibility Error	d7	Humidity Sensor Error	y8	Indoor Air Box Sensor Error
Lb	Inconsistency of Group-controlled Indoor Units in Reheat Dehumidification System	d8	Water Temperature Abnormality	y9	Outdoor Air Box Sensor Error
LC	Outdoor-Indoor Incompatibility Error	d9	Jumper Cap Error		
LF	Shunt Valve Setting Error	dA	Indoor Unit Hardware Address Error		

### 5.3 Table of debugging codes

Error Code	Content	Error Code	Content	Error Code	Content
U2	Outdoor Unit Capacity Code/Jumper Cap Setting Error	UL	Emergency Operation DIP switch setting of the compressor is wrong.	CE	Communication Failure Between Mode Exchanger and Indoor Unit
U3	Phase Sequence Protection of Power Supply	C0	Communication between indoor unit and outdoor unit and the communication between indoor unit and wired controller have malfunction.	CF	Error of Multiple Master Indoor Unit
U4	Protection of Lack of Refrigerant	C2	Communication error between master control and inverter compressor drive	CH	Rated capacity is too high.
U5	Wrong Address of Compressor Drive Board	C3	Communication error between master control and inverter fan motor drive	CJ	System addresses is incompatible.
U6	Valve Abnormal Alarm	C4	Error of Lack of Indoor Unit	CL	Rated capacity is too low.
U8	Indoor Unit Tube Malfunction	C5	Alarm of Indoor Unit Project Number Collision	Cn	Indoor and Outdoor Network Error of Mode Exchanger

U9	Outdoor Unit Tube Malfunction	C6	Alarm of Wrong Number of Outdoor Unit	CP	Error of Multiple Master Wired Controller
UC	Master indoor unit is successfully set.	C7	Mode Exchanger Communication Error	CU	Communication Error between Indoor Unit and Remote Receiver
UE	Refrigerant Charging is ineffective.	Cb	Outflow of Units IP Address	Cy	Communication Error of No Master in Mode Exchanger
UF	Indoor Unit Identification Error of Mode Exchanger	Cd	Communication Failure Between Mode Exchanger and Outdoor Unit		

## 5.4 Table of status codes

Error Code	Content	Error Code	Content	Error Code	Content
A0	Unit is waiting for debugging.	A8	Vacuum-pumping Mode	AJ	Filter Clean Reminder
A1	Check the compressor operation parameters.	Ab	Emergency Stop	AU	Remote Urgent Stop
A2	After-sales Refrigerant Reclaim	Ad	Operation Restriction	n3	Compulsory defrosting
A3	Defrosting	AC	Cooling	qE	EVI Operating Mode
A4	Oil return	AF	Fan		
A5	Online Testing	AH	Heating		

**GREE ELECTRIC APPLIANCES, INC. OF ZHUHAI**

Add: West Jinji Rd, Qianshan, Zhuhai, Guangdong, China, 519070

Tel: (+86-756) 8522218 Fax: (+86-756) 8669426

E-mail: [gree@gree.com.cn](mailto:gree@gree.com.cn) [www.gree.com](http://www.gree.com)



66170050102