



# **Owner's Manual**

## **Original Instructions**

# Central Air Conditioner Thermostat

Model:

WK-010PN WK-011PN

Thank you for choosing commercial air conditioners. Please read this Owner's Manual carefully before operation and retain it for future reference.

If you have lost the Owner's Manual, please contact the local agent or visit [www.gree.com](http://www.gree.com) or send an email to [global@cn.gree.com](mailto:global@cn.gree.com) for the electronic version.

GREE ELECTRIC APPLIANCES, INC. OF ZHUHAI

## To Users

Thank you for selecting Gree's product. Please read this instruction manual carefully before installing and using the product, so as to master and correctly use the product. In order to guide you to correctly install and use our product and achieve expected operating effect, we hereby instruct as below:

- (1) This instruction manual is a universal manual, some functions are only applicable to particular product. All the illustrations and information in the instruction manual are only for reference.
- (2) All the illustrations and information in the instruction manual are only for reference. In order to make the product better, we will continuously conduct improvement and innovation without further notice.
- (3) For personal injury or property loss and damage caused by improper operation such as improper installation and debugging, unnecessary maintenance, violation of related national laws and rules and industrial standard, and violation of this instruction manual, etc., we will bear no liability.

# Contents

Safety notices (Please be sure to abide).....	1
1 Thermostat panel and keys .....	2
2 Technical parameters .....	3
3 Components inside the packing box.....	3
4 Installation of the thermostat .....	4
6 Ambient temperature sensor failure.....	23
7 Failure handling .....	24

## **Safety notices (Please be sure to abide)**

Thank you for choosing the Gree's thermostat. Read the Manual and retain it for a proper and safe operation of the product before use.

Special notice: the pictures provided by the Manual may be different from the actual objects and the latter always prevail.

Symbols:

 identifies instructions that must be forbidden.

 indicates instructions that must be followed.

# 1 Thermostat panel and keys

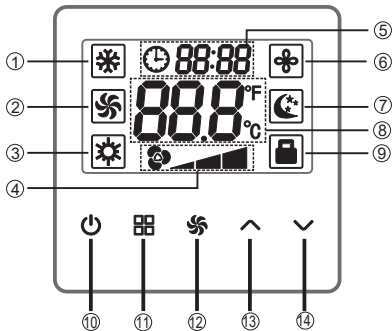

①	Cooling mode	⑧	Temperature or failure codes
②	Air supplying mode	⑨	Child lock
③	Heating mode	⑩	ON/OFF
④	Fan speed	⑪	MODE
⑤	Timer	⑫	SPEED
⑥	Drying function	⑬	UP
⑦	Sleep function	⑭	DOWN

## 2 Technical parameters

Item	Description
Supply voltage	AC85~265V 50/60Hz
Temperature setting	16~35°C
Operation temperature	0~50°C
Humidity	Relative humidity 5~95% (no condensate)
Load current	2A (resistive load); 1A (inductive load)
Connecting terminal	Less than 2.5mm <sup>2</sup> wires
Outline dimensions	86×86×10mm (Width × Height × Thickness)
Protection class	IP 30
Installation requirement	An 86x86 unconcealed or concealed standard junction box with more than 40mm interior height and standard 60mm hole spacing

## 3 Components inside the packing box

Item	Number
Operating manual	1
Installation screws	2

## 4 Installation of the thermostat

- ⊘ It should not be fitted in the positions below:
- (4) Closed thermal pipelines and flues.
  - (5) Near cool and hot air pipes and radiators.
  - (6) Near direct sunlight, airflow and other heating objects (such as a television).
  - (7) Corners, edges of doors and windows and the front and back of doors.

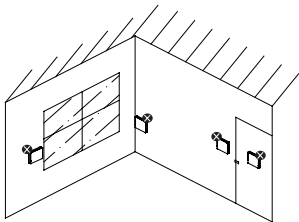

**!** Notice

- (1) Hard plastic lines, if used, must be bent at a proper angle.
- (2) Wire in accordance with the wiring diagram.
- (3) Fit the thermostat in accordance with the installation diagram.
- (4) One thermostat can only drive a two-row-coil unit and an electric water valve.

## Central Air Conditioner Thermostat

---

- (5) When removing the flexible flat cable (FFP), unplug its end with the thumb and the index finger but not pull its main body.
- (6) Do not hurl it or press forcibly its LCD.
- (7) Don't hit and drop it, and protect it from deformation.
- (8) Keep its inside clean against other objects such as water and mud.
- (9) The 86x86 junction box shall be subject to the flame-retardant class.
- (10) No inflammables are placed near the installation locations.
- (11) A fireproof metallic 86x86 junction box is required to be used for fireproof areas.

### 4.1 Installation position

**!** As shown in the picture below, the thermostat should be fitted on the position 1.5 meters above the floor.

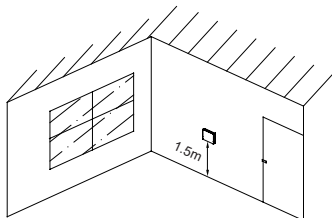



## 4.2 Installation preparations

- (1) Cut off the main power supply.
- (2) Label each conductor and wire them according to the wiring diagram.
- (3) Remove the protective film on the LCD before use.

## 4.3 Installation procedures

Follow the installation diagram to assemble the components.

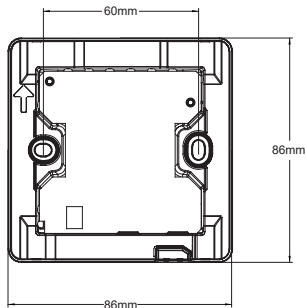

Installation dimension

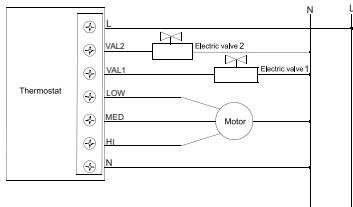

Wiring diagram

Notes:

VAL1 is connected with a cold water valve and VAL2 with a hot water valve (or other hot source loads).

## Central Air Conditioner Thermostat

a. Put a 3.5mm slotted screwdriver into the groove, and then separate the front panel from the clasp by proper upward force.

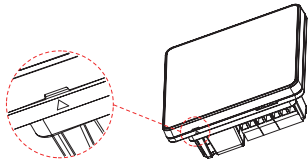

b. Remove the seven-core FFP on the control board.

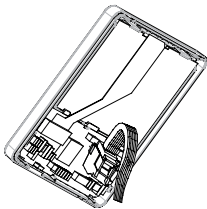

c. Wire conductors according to the wiring diagram.

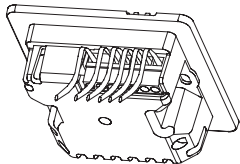

d. Screw the back cover with wired conductors to the junction box.

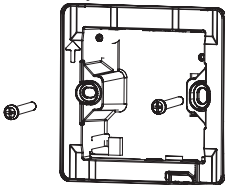

e. Connect the FFP on the control board.

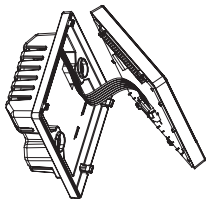

f. Put the panel to clasps of the back cover and press by proper force its two lower sides.

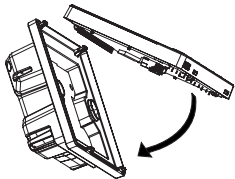

## 5 Thermostat operations

The thermostat backlight will be off after 20 continuous seconds without a key press on the panel or the remote controller. Then, any key press on the panel will enable the backlight (that will flash once if the user operates the remote controller) indicating that the user can begin to use the thermostat.

Notes:

Remote controller model YB1FA (MOTO) is recommended for WK-011PN, not for WK-010PN which does not support remote control. Use the remote controller to set the temperature between 16 to 30°C.

## 5.1 ON/OFF

As shown in Figure 1, press  (ON/OFF) to start or stop the unit. If it is on, the screen provides the operation mode, temperature and fan speed, among which only temperature appears if it is off.

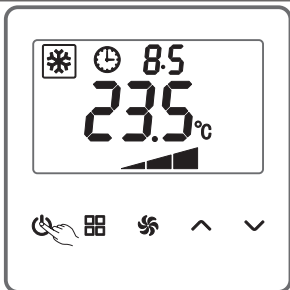



Figure 1

## 5.2 Mode setting

As shown in the Figure 2, press  (MODE) to switch between three modes after starting the unit.

Switch sequence:

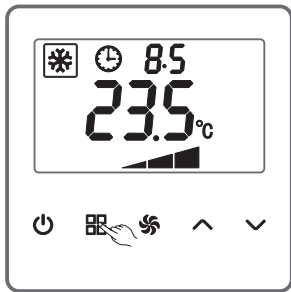
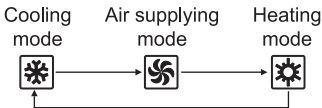
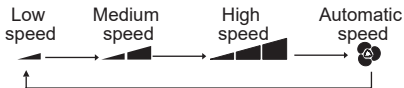

Figure 2



## 5.3 Fan speed

As shown in the Figure 2, press  (SPEED) to switch between four speeds of the fan after starting the unit.

Switch sequence:



## 5.4 Temperature setting

- (1) During the operation of the unit, press  (UP) or  (DOWN) to raise or lower the temperatures.
- (2) When the temperature unit is Celsius, one press of the UP key or the DOWN key causes a 0.5°C increase or decrease within 16°C~35°C.
- (3) When the temperature unit is Fahrenheit, one press of the UP key or the DOWN key causes a 1°F increase or decrease within 61°F~95°F.
- (4) When keeping pressing the UP key or the DOWN key, the temperature varies every 0.5 second.
- (5) As shown in Figure 3, the indoor ambient temperature display, if activated, will appear by default after the unit is started. A desired temperature being set appears temporarily. Later, the default temperature will reappear without any operation in 5 seconds.

## Central Air Conditioner Thermostat

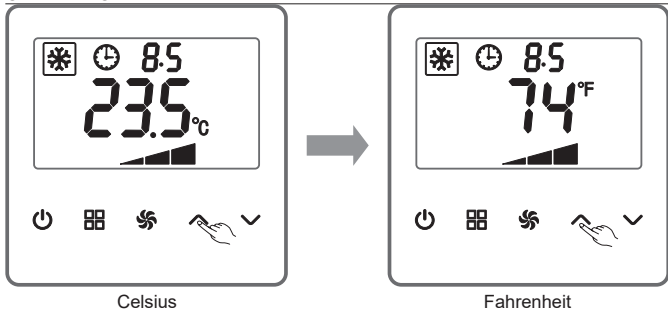





Figure 3

## 5.5 Timer

- (1) The unit is timed to start or stop, ranging from 0.5 to 24 hours.
- (2) As shown in the Figure 4, after starting the unit, to keep pressing  (SPEED) for about 5 seconds (press keeping hereinafter lasts 5 seconds) can disable or enable the timer. When enabling the timer, the symbol  flashes. A press of 

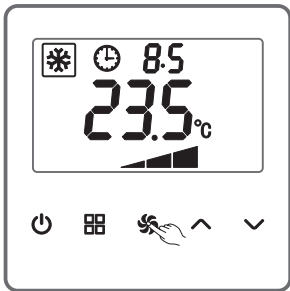

Figure 4

(UP) or ▼ (DOWN) increases or reduces 0.5 hour in the amount of time. A press of 🌀 (SPEED) ensures saving the timer setting. The symbol 🕒 stops flashing and continue to be visible, which means the timer has been working and the countdown is displayed.



(3) After a stoppage of the unit, the unit is specified a time to start in the way to stop. The countdown will be displayed.

Notice:

During the timing process, the homepage is shown by default after 5 continuous seconds without a key press. In this case, press keeping of ^ (UP) or ▼ (DOWN) adjusts the amount of time every 0.5 second.

## 5.6 Child lock

After a start or stop of the unit, press keeping of both ^ (UP) and ▼ (DOWN) enables or disables the child lock that will recover after the power failure.

As shown in the Figure 5, the symbol  that appears will be activated to flash for 3 seconds by a press of any other keys, reminding the user of the child lock functioning. The symbol  is not displayed when the child lock is off.

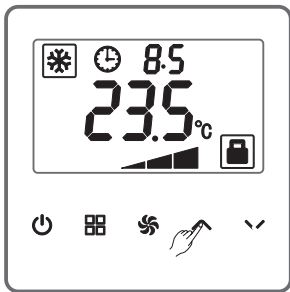



Figure 5

## 5.7 Sleep function

As shown in the Figure 6, during the operation of the unit, press keeping of  (MODE) enables or disables the function. When it is enabled, the homepage displays the symbol .

Notice:

In the cooling mode, using the sleep function, the set temperature will rise 1°C after operating in 1 hour and another 1°C in another 1 hour. The set temperature will rise 2°C at most and be steady at 28°C with the function automatically disabled.

In the heating mode, using the sleep function, the set temperature will drop 1°C after operating in 1 hour and another 1°C in another 1 hour. The set temperature will drop 2°C at most and be steady at 16°C with the function automatically disabled.

The fan automatically runs at the low speed.

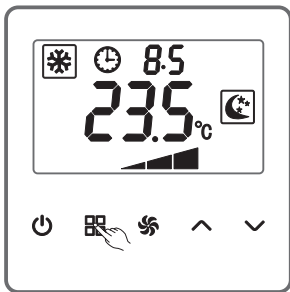









Figure 6



## 5.8 Parameter setting

(1) After a stop of the unit, press keeping of both  (SPEED) and  (UP) is an access to parameter setting page. Set the serial numbers of parameters by tapping  (MODE) and decide the parameter values by  (UP) or  (DOWN).

(2) Next, press keeping of both  (SPEED) and  (UP) ensures saving all the parameter values. Then, the parameter setting page automatically exits. Whereas, the parameter setting page automatically exits, not saving all values without any operation in 20 seconds.

(3) Parameter list:

S.N	Name	Description
01	Power failure memory	ON: enable (by default); OFF: disable
02	Energy saving function	ON: enable; OFF: disable (by default)
03	Drying function	ON: enable; OFF: disable (by default)
04	Temperature unit setting	F: Fahrenheit; C: Celsius (by default)
05	Fan operation at temperature set points	00: the fan works as to the set speed; 01: the fan works at the low speed; 02: the fan stops (by default)
06	Temperature calibration	Adjustable range: -5°C~+5°C (a precision of 0.5°C, 0°C by default)

## Central Air Conditioner Thermostat



S.N	Name	Description
07	Temperature control range	1: narrow ; 2: medium (by default); 3: wide
08	Cooling temperature set in the energy saving mode	Adjustable range: 16°C~35°C (a precision of 0.5°C, 16°C by default); When the temperature unit is Fahrenheit, the adjustment range of the temperature is 61°F~95°F (a precision of 1°F).
09	Heating temperature set in the energy saving mode	Adjustable range: 16°C~35°C (a precision of 0.5°C, 35°C by default); When the temperature unit is Fahrenheit, the adjustment range of the temperature is 61°F~95°F (a precision of 1°F).
10	Ambient temperature display	ON: enable; OFF: disable (by default)
11	Factory data reset	ON: enable; OFF: disable (by default)

### 5.8.1 Instructions of setting the parameters

#### (1) Power failure memory

When the function is enabled, if a power failure occurs while the unit is working or stopped, the last screen of data that was collected will be displayed upon restoration of power.

When the function is disabled, if a power failure occurred while the unit was stopped, it will automatically restart with a unit stop display when power is restored.

As shown in the Figure 7 (the function has been disabled), on the parameter setting page, press  (MODE) to switch the option number to 01.  (UP) or  (DOWN) is provided to allow a switch between ON and OFF (—enable or disable the function).

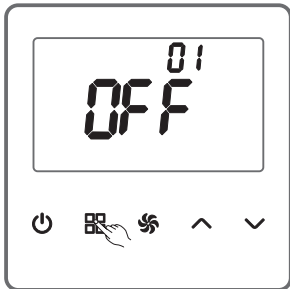





Figure 7

## (2) Energy saving function

The unit is allowed to cool or heat in the energy saving mode (08, 09 in the list). Energy will be saved when the air conditioner operates within a small range by limiting the cooling and heating temperatures.

- 1) The sleep mode is also available upon the energy saving mode.
- 2) If a power failure occurs, the energy saving mode will restart upon the restoration of power.
- 3) If the set temperature in any other modes exceeds the limit of energy saving mode, the temperature will be adjusted to the limit value.

## Central Air Conditioner Thermostat

As shown in the Figure 8, on the parameter setting page, press  (MODE) to switch the option number to 02.  (UP) or  (DOWN) is provided to allow a switch between ON and OFF.

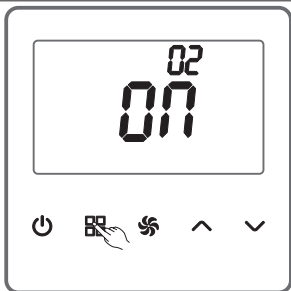





Figure 8

### (3) Drying function

If it is enabled while the unit is working in the cooling condition, the symbol  will be displayed. Pressing ON/OFF key to stop the unit, the interior fan will cease after 2-minute running. Then, the symbol  will not be displayed if drying is done.

The function is not available in the air supplying and heating modes. The symbol

 will not be displayed.

As shown in the Figure 9, on the

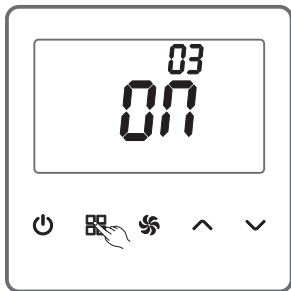







Figure 9

parameter setting page, press  (MODE) to switch the option number to 03.

 (UP) or  (DOWN) is provided to allow a switch between ON and OFF.

#### (4) Temperature unit setting

Celsius (°C) or Fahrenheit (°F) is available. As shown in the Figure 10, on the parameter setting page, press  (MODE) to switch the option number to 04.  (UP) or  (DOWN) is provided to allow a switch between Celsius (°C) and Fahrenheit (°F).

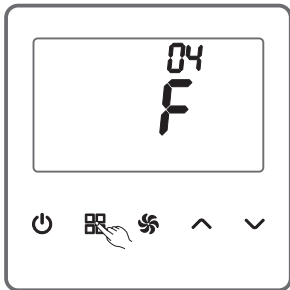





Figure 10

#### (5) Fan operation at temperature set points

The fan is able to run at the set speed, low speed or stop working when the indoor ambient temperature reaches the specific temperature point.

As shown in the Figure 11 on the parameter setting page, pressing  (MODE) activates a switch to the option number 05.  (UP) or  (DOWN)

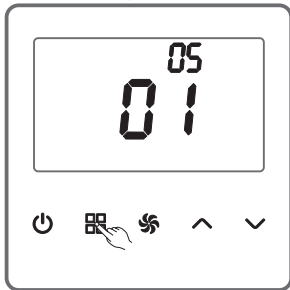





Figure 11

## Central Air Conditioner Thermostat

is provided to allow a switch between “00”, “01” and “03”, adjusting the fan operation.

### (6) Temperature calibration

The ambient temperature is allowed to be calibrated between  $-5^{\circ}\text{C}$  and  $+5^{\circ}\text{C}$  with a precision of  $0.5^{\circ}\text{C}$ .

As shown in the Figure 12, on the parameter setting page, press  (MODE) to switch the option number to 06.  (UP) or  (DOWN) is provided to a  $0.5^{\circ}\text{C}$  increase or decrease within  $-5^{\circ}\text{C}\sim+5^{\circ}\text{C}$ .

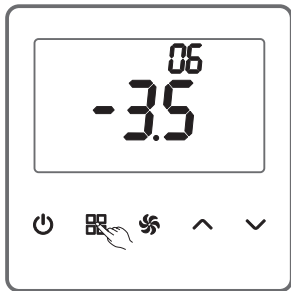





Figure 12

### (7) Temperature variation range

With the narrow range, the temperature features a small amount of variation for great comfort, but the fan and water valve will operate more frequently causing loss of service life. Whereas, the wide range does good to duration of the fan and water valve with a large amount of temperature variation and low frequency operation. The medium range (“2”) is adopted by default which is advisable. The three ranges above are available.

As shown in the Figure 13, on the parameter setting page, press  (MODE) to switch the option number to 07.  (UP) or  (DOWN) is provided to a switch between “1”, “2” and “3” (the three ranges).

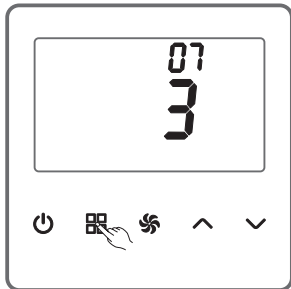





Figure 13

(8) Cooling temperature set in the energy saving mode

It is available when energy saving function is enabled. The cooling temperature is limited between 16°C and 35°C (61°F~95°F).

As shown in the Figure 14, on the parameter setting page, press  (MODE) to switch the option number to 08.  (UP) or  (DOWN) is provided to allow a rise or

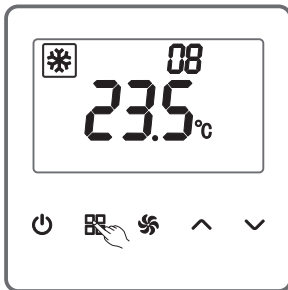





Figure 14

## Central Air Conditioner Thermostat

drop on the temperature. If the temperature unit is Celsius, the adjustment range is 16°C~35°C with a precision of 0.5°C. If the temperature unit is Fahrenheit, the adjustment range is 61°F~95°F with a precision of 1°F.

### (9) Heating temperature set in the energy saving mode

It is available when energy saving function is enabled. The heating temperature is limited between 16°C and 35°C (61°F~95°F).

As shown in the Figure 15, on the parameter setting page, press  (MODE) to switch the option number to 09.  (UP) or  (DOWN) is provided to allow a rise or drop on the temperature. If the temperature unit is Celsius, the adjustment range of the temperature is 16°C~35°C with a precision of 0.5°C. If the temperature unit is Fahrenheit, the adjustment range of the temperature is 61°F~95°F with a precision of 1°F.

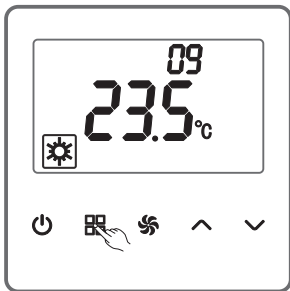

Figure 15



## (10) Ambient temperature display

If the user enables the indoor ambient temperature display after the start-up of the unit, the indoor ambient temperature will be displayed by default. While the user is setting a desirable temperature, the screen provides the desirable temperature. The screen will display the indoor ambient temperature after 5 continuous seconds without a key press.

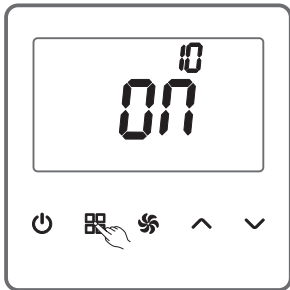





Figure 16



The screen will not display the indoor ambient temperature that was disabled but the set temperature.

As shown in the Figure 16, on the parameter setting page, press  (MODE) to switch the option number to 10.  (UP) or  (DOWN) is provided to allow a switch between ON and OFF.

## Central Air Conditioner Thermostat

### (11) Factory data reset

All parameters [5.8 (3)] can be reset to factory defaults.

As shown in the Figure 17, on the parameter setting page, press  (MODE) to switch the option number to 11.  (UP) or  (DOWN) is provided to allow a switch between ON and OFF.

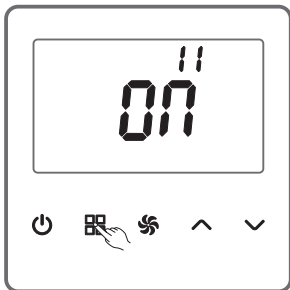

Figure 17

## 6 Ambient temperature sensor failure

As shown in the Figure 18, if the ambient temperature sensor fails to work, the screen will not display the ambient temperature or the set temperature but “F5”. In this case, the unit continues to work at 24°C, an ambient temperature. The user is allowed to adjust the set temperature.

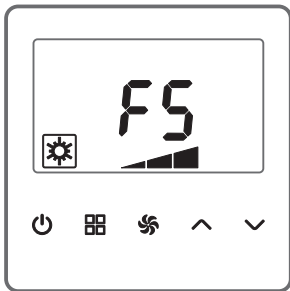

Figure 18

No.	Code	Description
1	F5	Indoor ambient temperature sensor failure

## 7 Failure handling

The product maintenance is performed by qualified technicians only.

Status	Maintenance approaches
Start-up failure	<ol style="list-style-type: none"> <li>1. Check if L/N lines work well and wiring is safe.</li> <li>2. Check if ON/OFF key is effective.</li> <li>3. Try to replace the main control panel first. If it does not work, replace the power panel.</li> </ol>
Unrecognizable code on the LCD	Loosen the fixing screws as the panel is not fitted properly.
Blown fuses	<ol style="list-style-type: none"> <li>1. Check if wiring is correct.</li> <li>2. Replace the power panel.</li> </ol>
Abnormal output with a normal display	Try to replace the main control panel first. If it does not work, replace the power panel.



GREE ELECTRIC APPLIANCES, INC. OF ZHUHAI

Add: West Jinji Rd, Qianshan, Zhuhai, Guangdong, China, 519070

Tel: (+86-756) 8522218

Fax: (+86-756) 8669426

E-mail: [global@cn.gree.com](mailto:global@cn.gree.com) [www.gree.com](http://www.gree.com)



600005062195